

Deutsches Institut für Bautechnik

Anstalt des öffentlichen Rechts

Kolonnenstr. 30 L
10829 Berlin
Germany

Tel.: +49(0)30 787 30 0
Fax: +49(0)30 787 30 320
E-mail: dibt@dibt.de
Internet: www.dibt.de

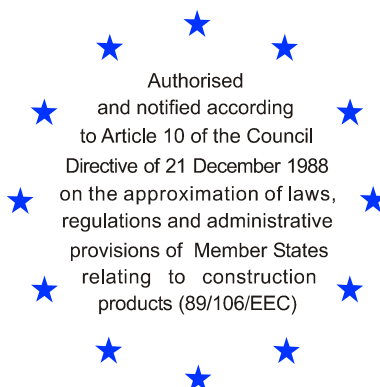

DIBt

Mitglied der EOTA
Member of EOTA

European Technical Approval ETA-04/0116

English translation prepared by DIBt - Original version in German language

Handelsbezeichnung <i>Trade name</i>	ATRION Verbundmörtelsystem AVM-BGZ / -R / -HCR <i>ATRION Injection System AVM-BGZ / -R / -HCR</i>
Zulassungsinhaber <i>Holder of approval</i>	Adolf Würth GmbH & Co. KG Reinhold-Würth-Straße 12-17 74653 Künzelsau DEUTSCHLAND
Zulassungsgegenstand und Verwendungszweck <i>Generic type and use of construction product</i>	Kraftkontrolliert spreizender Verbunddübel mit Ankerstange in den Größen M8, M10, M12, M16, M20 und M24 zur Verankerung im Beton <i>Torque controlled bonded anchor with anchor rod of sizes M8, M10, M12, M16, M20 and M24 for use in concrete</i>
Geltungsdauer: <i>Validity:</i>	vom <i>from</i> 24 November 2009 bis <i>to</i> 31 July 2014
Herstellwerk <i>Manufacturing plant</i>	Werk A, Deutschland

Diese Zulassung umfasst
This Approval contains

20 Seiten einschließlich 12 Anhänge
20 pages including 12 annexes

Diese Zulassung ersetzt
This Approval replaces

ETA-04/0116 mit Geltungsdauer vom 07.04.2006 bis 01.11.2009
ETA-04/0116 with validity from 07.04.2006 to 01.11.2009



Europäische Organisation für Technische Zulassungen
European Organisation for Technical Approvals

I LEGAL BASES AND GENERAL CONDITIONS

- 1 This European technical approval is issued by Deutsches Institut für Bautechnik in accordance with:
 - Council Directive 89/106/EEC of 21 December 1988 on the approximation of laws, regulations and administrative provisions of Member States relating to construction products¹, modified by Council Directive 93/68/EEC² and Regulation (EC) N° 1882/2003 of the European Parliament and of the Council³;
 - Gesetz über das In-Verkehr-Bringen von und den freien Warenverkehr mit Bauprodukten zur Umsetzung der Richtlinie 89/106/EWG des Rates vom 21. Dezember 1988 zur Angleichung der Rechts- und Verwaltungsvorschriften der Mitgliedstaaten über Bauprodukte und anderer Rechtsakte der Europäischen Gemeinschaften (Bauprodukten-gesetz - BauPG) vom 28. April 1998⁴, as amended by law of 31 October 2006⁵;
 - Common Procedural Rules for Requesting, Preparing and the Granting of European technical approvals set out in the Annex to Commission Decision 94/23/EC⁶;
 - Guideline for European technical approval of "Metal anchors for use in concrete - Part 5: Bonded anchors", ETAG 001-05.
- 2 Deutsches Institut für Bautechnik is authorized to check whether the provisions of this European technical approval are met. Checking may take place in the manufacturing plant. Nevertheless, the responsibility for the conformity of the products to the European technical approval and for their fitness for the intended use remains with the holder of the European technical approval.
- 3 This European technical approval is not to be transferred to manufacturers or agents of manufacturers other than those indicated on page 1, or manufacturing plants other than those indicated on page 1 of this European technical approval.
- 4 This European technical approval may be withdrawn by Deutsches Institut für Bautechnik, in particular pursuant to information by the Commission according to Article 5(1) of Council Directive 89/106/EEC.
- 5 Reproduction of this European technical approval including transmission by electronic means shall be in full. However, partial reproduction can be made with the written consent of Deutsches Institut für Bautechnik. In this case partial reproduction has to be designated as such. Texts and drawings of advertising brochures shall not contradict or misuse the European technical approval.
- 6 The European technical approval is issued by the approval body in its official language. This version corresponds fully to the version circulated within EOTA. Translations into other languages have to be designated as such.

1 Official Journal of the European Communities L 40, 11 February 1989, p. 12

2 Official Journal of the European Communities L 220, 30 August 1993, p. 1

3 Official Journal of the European Union L 284, 31 October 2003, p. 25

4 *Bundesgesetzblatt Teil I 1998*, p. 812

5 *Bundesgesetzblatt Teil I 2006*, p. 2407, 2416

6 Official Journal of the European Communities L 17, 20 January 1994, p. 34

II SPECIFIC CONDITIONS OF THE EUROPEAN TECHNICAL APPROVAL

1 Definition of the product and intended use

1.1 Definition of the construction product

The ATRION Injection System AVM-BGZ / -R / -HCR is a torque controlled bonded anchor consisting of a mortar cartridge with ATRION Injection Adhesive AVM-BGZ and an anchor rod with hexagon nut and washer in the sizes of M8, M10, M12, M16, M20 and M24.

The load transfer is realised by mechanical interlock of several cones in the bonding mortar and then via a combination of bonding and friction forces in the anchorage ground (concrete).

An illustration of the product and intended use is given in Annex 1.

1.2 Intended use

The anchor is intended to be used for anchorages for which requirements for mechanical resistance and stability and safety in use in the sense of the Essential Requirements 1 and 4 of Council Directive 89/106 EEC shall be fulfilled and failure of anchorages made with these products would cause risk to human life and/or lead to considerable economic consequences. Safety in case of fire (Essential Requirement 2) is not covered in this European technical approval. The anchor is to be used only for anchorages subject to static or quasi-static loading in reinforced or unreinforced normal weight concrete of strength classes C20/25 at minimum and C50/60 at most according to EN 206:2000-12.

The anchor may be anchored in cracked and non-cracked concrete.

The anchor sizes M12 to M24 may be installed in dry or wet concrete or in flooded holes. The anchor sizes M8 and M10 may only be installed in dry or wet concrete.

The anchor may be used in the following temperature ranges:

Temperature range: -40 °C to +80 °C (max short term temperature +80 °C and
max long term temperature +50 °C)

Temperature range: -40 °C to +120 °C (max short term temperature +120 °C and
max long term temperature +72 °C)

Anchor rods made of galvanised steel:

The element made of galvanised steel may only be used in structures subject to dry internal conditions.

Anchor rods made of stainless steel (A4):

The element made of stainless steel 1.4401, 1.4404, 1.4571 or 1.4362 may be used in structures subject to dry internal conditions and also in structures subject to external atmospheric exposure (including industrial and marine environment), or exposure to permanently damp internal conditions, if no particular aggressive conditions exist. Such particular aggressive conditions are e.g. permanent, alternating immersion in seawater or the splash zone of seawater, chloride atmosphere of indoor swimming pools or atmosphere with extreme chemical pollution (e.g. in desulphurization plants or road tunnels where de-icing materials are used).

Anchor rods made of high corrosion resistant steel (HCR):

The element made of high corrosion resistant steel 1.4529 or 1.4565 may be used in structures subject to dry internal conditions and also in structures subject to external atmospheric exposure, in permanently damp internal conditions or in other particular aggressive conditions. Such particular aggressive conditions are e. g. permanent, alternating immersion in seawater or the splash zone of seawater, chloride atmosphere of indoor swimming pools or atmosphere with chemical pollution (e.g. in desulphurization plants or road tunnels where de-icing materials are used).

The provisions made in this European technical approval are based on an assumed working life of the anchor of 50 years. The indications given on the working life cannot be interpreted as a guarantee given by the producer, but are to be regarded only as a means for choosing the right products in relation to the expected economically reasonable working life of the works.

2 Characteristics of product and methods of verification

2.1 Characteristics of product

The anchor corresponds to the drawings and provisions given in Annexes 1 to 3. The characteristic material values, dimensions and tolerances of the anchor not indicated in Annexes 1 to 3 shall correspond to the respective values laid down in the technical documentation⁷ of this European technical approval.

The characteristic values for the design of anchorages are given in Annexes 8 to 12.

Each anchor rod shall be marked with the identifying mark of the producer (works symbol), the anchorage depth, trade name, thread size, marking of effective anchorage depth, maximum thickness of the fixture and marking of length in accordance with Annex 2.

Each anchor rod made of stainless steel 1.4401, 1.4404, 1.4571 or 1.4362 is marked with the additional letter "A4". Each anchor rod made of high corrosion resistant steel 1.4529 or 1.4565 is marked with the additional letter "HCR".

Each mortar cartridge shall be marked with the identifying mark of the producer and with the trade name, processing notes, shelf life, hazard code, curing time and processing time (depending on temperature) in accordance with Annex 3.

2.2 Methods of verification

The assessment of fitness of the anchor for the intended use in relation to the requirements for mechanical resistance and stability and safety in use in the sense of the Essential Requirements 1 and 4 has been made in accordance with the "Guideline for European technical approval of Metal Anchors for Use in Concrete", Part 1 "Anchors in general" and Part 5 "Bonded anchors" as well as the Technical Report TR 018 "Torque-controlled bonded anchors", on the basis of Option 1.

In addition to the specific clauses relating to dangerous substances contained in this European technical approval, there may be other requirements applicable to the products falling within its scope (e.g. transposed European legislation and national laws, regulations and administrative provisions). In order to meet the provisions of the Construction Products Directive, these requirements need also to be complied with, when and where they apply.

⁷ The technical documentation of this European technical approval is deposited at the Deutsches Institut für Bautechnik and, as far as relevant for the tasks of the approved bodies involved in the attestation of conformity procedure, is handed over to the approved bodies.

3 Evaluation and attestation of conformity and CE marking

3.1 System of attestation of conformity

According to the decision 96/582/EG of the European Commission⁸ the system 2(i) (referred to as System 1) of attestation of conformity applies.

This system of attestation of conformity is defined as follows:

System 1: Certification of the conformity of the product by an approved certification body on the basis of:

- (a) Tasks for the manufacturer:
 - (1) factory production control;
 - (2) further testing of samples taken at the factory by the manufacturer in accordance with a prescribed test plan;
- (b) Tasks for the approved body:
 - (3) initial type-testing of the product;
 - (4) initial inspection of factory and of factory production control;
 - (5) continuous surveillance, assessment and approval of factory production control.

Note: Approved bodies are also referred to as "notified bodies".

3.2 Responsibilities

3.2.1 Tasks of the manufacturer

3.2.1.1 Factory production control

The manufacturer shall exercise permanent internal control of production. All the elements, requirements and provisions adopted by the manufacturer shall be documented in a systematic manner in the form of written policies and procedures, including records of results performed. This production control system shall insure that the product is in conformity with this European technical approval.

The manufacturer may only use initial / raw / constituent materials stated in the technical documentation of this European technical approval.

The factory production control shall be in accordance with the control plan of December 2008 which is part of the technical documentation of this European technical approval. The control plan is laid down in the context of the factory production control system operated by the manufacturer and deposited at Deutsches Institut für Bautechnik.⁹

The results of factory production control shall be recorded and evaluated in accordance with the provisions of the control plan.

3.2.1.2 Other tasks of manufacturer

The manufacturer shall, on the basis of a contract, involve a body which is approved for the tasks referred to in section 3.1 in the field of anchors in order to undertake the actions laid down in section 3.2.2. For this purpose, the control plan referred to in sections 3.2.1.1 and 3.2.2 shall be handed over by the manufacturer to the approved body involved.

The manufacturer shall make a declaration of conformity, stating that the product is in conformity with the provisions of this European technical approval.

⁸ Official Journal of the European Communities L 254 of 08.10.1996.

⁹ The control plan is a confidential part of the European technical approval and only handed over to the approved body involved in the procedure of attestation of conformity. See section 3.2.2.

3.2.2 Tasks of approved bodies

The approved body shall perform the following tasks in accordance with the provisions laid down in the control plan:

- initial type-testing of the product,
- initial inspection of factory and of factory production control,
- continuous surveillance, assessment and approval of factory production control.

The approved body shall retain the essential points of its actions referred to above and state the results obtained and conclusions drawn in a written report.

The approved certification body involved by the manufacturer shall issue an EC certificate of conformity of the product stating the conformity with the provisions of this European technical approval.

In cases where the provisions of the European technical approval and its control plan are no longer fulfilled the certification body shall withdraw the certificate of conformity and inform Deutsches Institut für Bautechnik without delay.

3.3 CE marking

The CE marking shall be affixed on each packaging of anchors. The letters "CE" shall be followed by the identification number of the approved certification body, where relevant, and be accompanied by the following additional information:

- the name and address of the holder of the approval (legal entity responsible for the manufacture),
- the last two digits of the year in which the CE marking was affixed,
- the number of the EC certificate of conformity for the product,
- the number of the European technical approval,
- the number of the guideline for European technical approval,
- use category (ETAG 001-1 Option 1),
- size.

4 Assumptions under which the fitness of the product for the intended use was favourably assessed

4.1 Manufacturing

The European technical approval is issued for the product on the basis of agreed data/information, deposited with Deutsches Institut für Bautechnik, which identifies the product that has been assessed and judged. Changes to the product or production process, which could result in this deposited data/information being incorrect, should be notified to Deutsches Institut für Bautechnik before the changes are introduced. Deutsches Institut für Bautechnik will decide whether or not such changes affect the European technical approval and consequently the validity of the CE marking on the basis of the European technical approval and if so whether further assessment or alterations to the European technical approval shall be necessary.

4.2 Installation

4.2.1 Design of anchorages

The fitness of the anchor for the intended use is given under the following conditions:

The anchorages are designed in accordance with the "Guideline for European technical approval of Metal Anchors for Use in Concrete", Annex C, Method A, for bonded anchors under the responsibility of an engineer experienced in anchorages and concrete work.

Verifiable calculation notes and drawings are prepared taking account of the loads to be anchored.

The position of the anchor is indicated on the design drawings (e.g. position of the anchor relative to reinforcement or to supports, etc.).

4.2.2 Installation of anchors

The fitness for use of the anchor can only be assumed if the anchor is installed as follows:

- anchor installation carried out by appropriately qualified personnel and under the supervision of the person responsible for technical matters of the site,
- use of the anchor only as supplied by the manufacturer without exchanging the components of an anchor,
- anchor installation in accordance with the manufacturer's specifications and drawings using the tools indicated in the technical documentation of this European technical approval,
- checks before placing the anchor to ensure that the strength class of the concrete in which the anchor is to be placed is in the range given and is not lower than that of the concrete to which the characteristic loads apply,
- check of concrete being well compacted, e.g. without significant voids,
- keeping the effective anchorage depth,
- edge distance and spacing not less than the specified values without minus tolerances,
- positioning of the drill holes without damaging the reinforcement,
- in case of aborted drill hole: the drill hole shall be filled with mortar,
- cleaning the drill hole by at least 2x blowing / 2x brushing / 2x blowing following the manufacturers installation instructions,
- Anchor sizes M8 and M10 must not be installed in flooded holes (removing possibly existing water in the drill hole completely),
- flooded holes must not be polluted - otherwise the drill hole cleaning must be repeated,
- mortar injection according to the installation instructions given in Annexes 5 to 7; the anchor component installation temperature shall be at least +5 °C; during curing of the injection mortar the temperature of the concrete must not fall below -5 °C; observing the curing time according to Annex 8, Table 5 until the anchor may be loaded,
- after the curing time fixing the member to be anchored by using a calibrated torque wrench by not exceeding the torque moment given in Annex 4, Table 4a and 4b.

5 Indications to the manufacturer

5.1 Responsibility of the manufacturer

It is in the responsibility of the manufacturer to ensure that the information on the specific conditions according to 1 and 2 including Annexes referred to and 4.2.1 and 4.2.2 as well as 5.1 is given to those who are concerned. This information may be made by reproduction of the respective parts of the European technical approval. In addition all installation data shall be shown clearly on the package and/or on an enclosed instruction sheet, preferably using illustration(s).

The minimum data required are:

- drill bit,
- hole depth,
- diameter of anchor rod,
- minimum effective anchorage depth,
- maximum thickness of the fixture,
- information on the installation procedure, including cleaning of the hole with the cleaning equipments, preferably by means of an illustration,
- anchor component installation temperature,
- ambient temperature of the concrete during installation of the anchor,
- admissible processing time (open time) of the mortar,
- curing time until the anchor may be loaded as a function of the ambient temperature in the concrete during installation,
- torque moment,
- identification of the manufacturing batch.

All data shall be presented in a clear and explicit form.

5.2 Packaging, transport and storage

The injection cartridges shall be protected against sun radiation and shall be stored according to the manufacturer's installation instructions in dry condition at temperatures of at least +5 °C to not more than +25 °C.

Mortar cartridges with expired shelf life must no longer be used.

The anchor shall only be packaged and supplied as a complete unit. Mortar cartridges may be packed separately from anchor rods (including nut and washer).

The manufacturer's installation instruction shall indicate that the ATRION Injection Adhesive AVM-BGZ shall be used with the corresponding anchor rods of the manufacturer according to Annex 2.

Dipl.-Ing. Gerhard Breitschaft
President of Deutsches Institut für Bautechnik
Berlin, 24 November 2009

beglaubigt
Tempel

Injection System AVM-BGZ, AVM-BGZ-R, AVM-BGZ-HCR

Sealing cap



Mortar cartridge



Imprint:
 ATRION Injection Adhesive AVM-BGZ
 Processing notes, shelf-life, hazard code
 Curing time and processing time (depending on temperature)

Static mixer



Steel brush



Blower nozzle

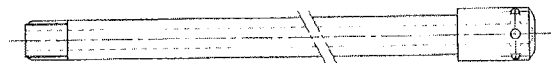

Anchor rod

Washer

Hexagon nut

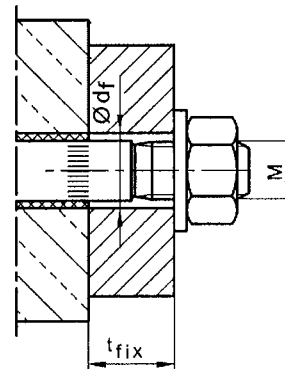
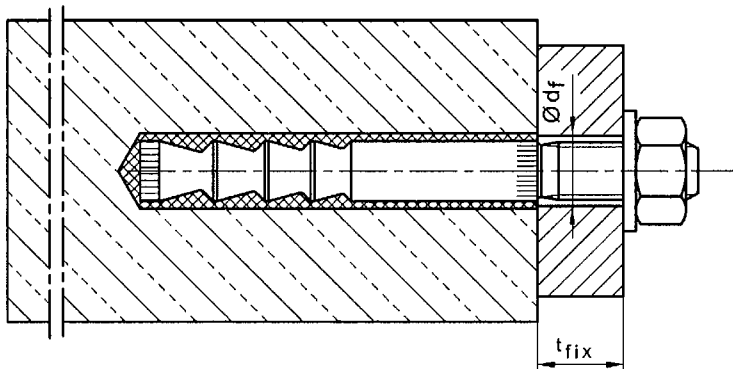
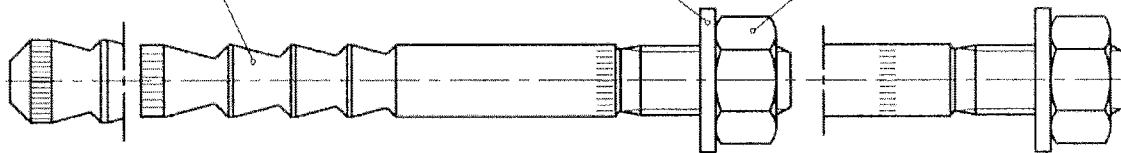

Pre-setting installation
 (and through-setting installation AVM-BGZ 75 M12, see Annex 7)

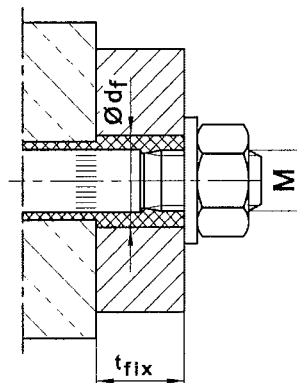
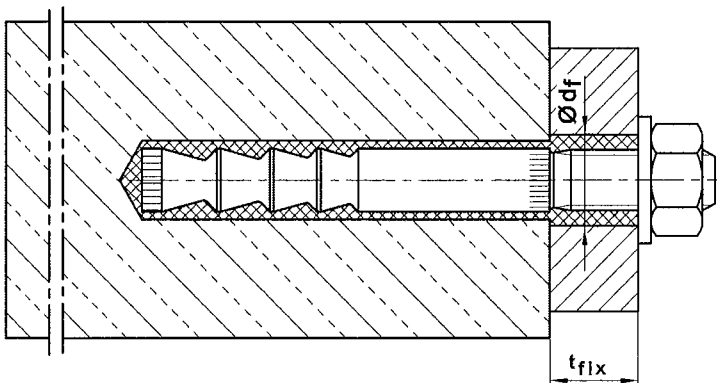

Through-setting installation

ATRION Injection System AVM-BGZ / -R / -HCR

Product and intended use

Annex 1

of European technical Approval

ETA-04/0116

Anchor rods

Marking: e.g. \diamond 95 VMZ 12-25 ...

- \diamond Identifying mark of manufacturing plant
- 95 Effective anchorage depth
- VMZ Trade name
- 12 Size of thread
- 25 Maximum thickness of fixture

- A4 additional marking of Stainless steel A4
- HCR additional marking of high corrosion resistant steel HCR

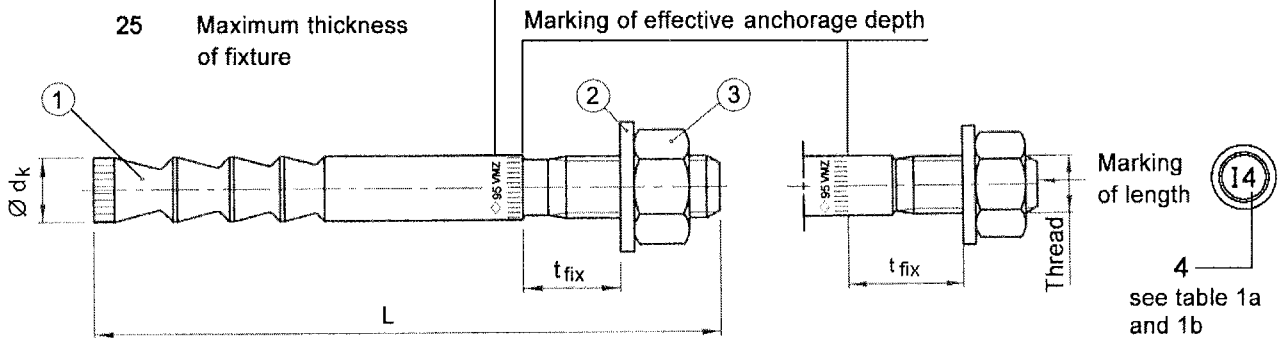

marking of length	B	C	D	E	F	G	H	I	J	K	L	M
length of anchor min \geq	50.8	63.5	76.2	88.9	101.6	114.3	127.0	139.7	152.4	165.1	177.8	190.5
length of anchor max $<$	63.5	76.2	88.9	101.6	114.3	127.0	139.7	152.4	165.1	177.8	190.5	203.2

marking of length	N	O	P	Q	R	S	T	U	V	W	X	Y	Z	>Z
length of anchor min \geq	203.2	215.9	228.6	241.3	254.0	279.4	304.8	330.2	355.6	381.0	406.4	431.8	457.2	482.6
length of anchor max $<$	215.9	228.6	241.3	254.0	279.4	304.8	330.2	355.6	381.0	406.4	431.8	457.2	482.6	

Table 1a: Dimensions of anchor rod M8 - M12

Anchor size		40	50	60	75	75	70	80	95	100	110	125
		M8	M8	M10	M10	M12	M12	M12	M12	M12	M12	M12
Additional marking		1	2	1	2	1	2	3	4	5	6	7
1	Anchor rod	Thread	M8	M8	M10	M10	M12	M12	M12	M12	M12	M12
		$\varnothing d_k$	8.0	8.0	9.7	9.7	10.7	12.5	12.5	12.5	12.5	12.5
		t_{fix} min	1	1	1	1	1	1	1	1	1	1
		t_{fix} max	3000	3000	3000	3000	3000	3000	3000	3000	3000	3000
		L min	53	64	76	91	96	91	101	116	121	131
		L max	3052	3063	3075	3090	3095	3090	3100	3115	3120	3130
3	Hexagon nut	SW	13	13	17	17	19	19	19	19	19	19

Dimensions in mm

Table 1b: Dimensions of anchor rod M16 – M24

Anchor size		90	105	125	145	115	170	190	170	200	225
		M16	M16	M16	M16	M20	M20	M20	M24	M24	M24
							(LG)	(LG)	(LG)	(LG)	(LG)
Additional marking		1	2	3	4	1	2	3	1	2	3
1	Anchor rod	Thread	M16	M16	M16	M16	M20	M20	M24	M24	M24
		$\varnothing d_k$	16.5	16.5	16.5	16.5	19.7	22.0	22.0	24.0	24.0
		t_{fix} min	1	1	1	1	1	20 (1)	20 (1)	20 (1)	20 (1)
		t_{fix} max	3000	3000	3000	3000	3000	3000	3000	3000	3000
		L min	115	130	151	171	144	204	224	211	241
		L max	3114	3129	3150	3170	3143	3203	3223	3240	3240
3	Hexagon nut	SW	24	24	24	30	30	30	36	36	36

ATRION Injection System AVM-BGZ / -R / -HCR

Dimensions of anchor rod

Annex 2

of European technical Approval

ETA-04/0116

Table 2a: Designation and materials of anchor parts

Part	Designation	Steel, zinc plated	Stainless steel A4	High corrosion resistant steel (HCR)
1	Anchor rod	Steel acc. to DIN EN 10087, galvanised and coated	Stainless steel, 1.4401, 1.4404, 1.4571, 1.4362, EN 10088, coated	High corrosion resistant steel 1.4529, 1.4565, acc. to EN 10088, coated
2	Washer	Steel, galvanised	Stainless steel, 1.4401, 1.4571, EN 10088	High corrosion resistant steel 1.4529 or 1.4565, acc. to EN 10088
3	Hexagon nut DIN 934	Property class 8 acc. to EN 20898-2, galvanised	ISO 3506, A4-70, 1.4401, 1.4571, EN 10088	ISO 3506, Property class 70, high corrosion resistant steel 1.4529 or 1.4565, EN 10088

Mortar cartridges

(different container sizes)

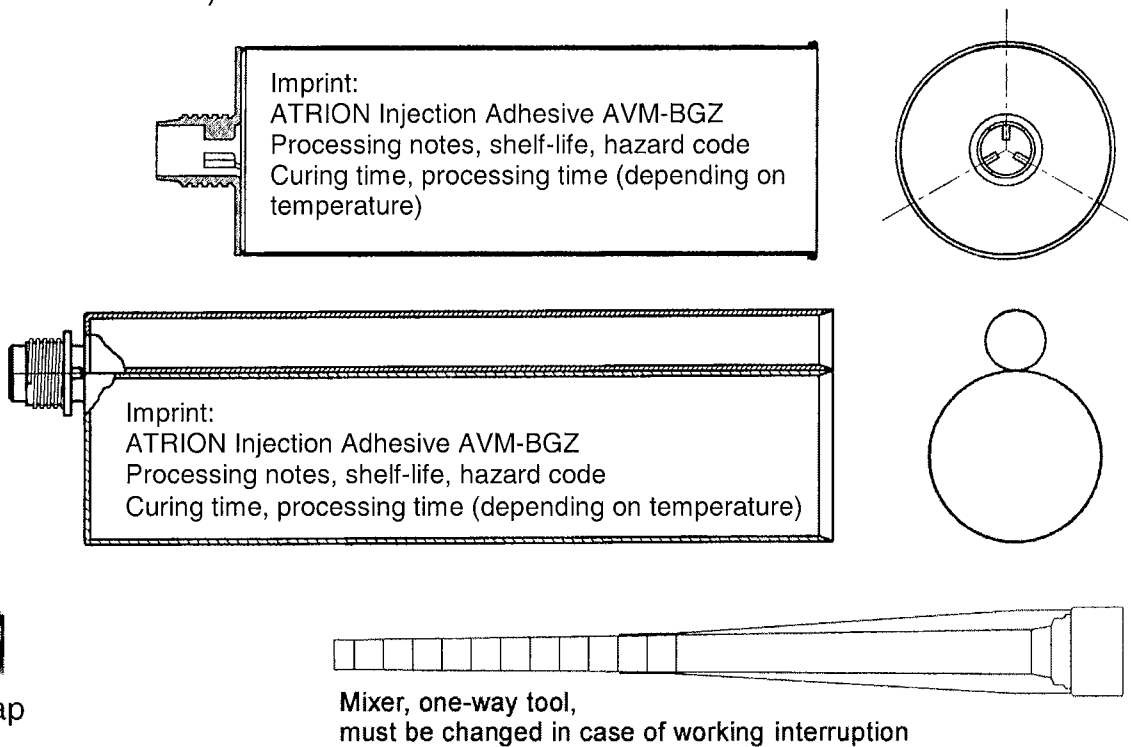

Table 2b: Designation and content of mortar cartridge

Part	Designation	Content
4	Mortar cartridge Mixing ratio 1:10	Vinylester resin, styrene free, mineral aggregate
	Sealing cap	

ATRION Injection System AVM-BGZ / -R / -HCR

**Materials of anchor parts,
Content of mortar cartridge**

Annex 3

of European
technical Approval

ETA-04/0116

Table 3: Installation conditions in concrete

Size	Installation in		
	dry concrete	wet concrete	flooded hole
M8 - M10	yes	yes	no
M12 - M24	yes	yes	yes

Table 4a: Installation parameters M8 – M12

Anchor size		40 M8	50 M8	60 M10	75 M10	75 M12	70 M12	80 M12	95 M12	100 M12	110 M12	125 M12
Effective anchorage depth	$h_{ef} =$ [mm]	40	50	60	75	75	70	80	95	100	110	125
Nominal diameter of drill hole	$d_0 =$ [mm]	10	10	12	12	12	14	14	14	14	14	14
Depth of drill hole	$h_0 \geq$ [mm]	42	55	65	80	80	75	85	100	105	115	130
Diameter of steel brush	$D \geq$ [mm]	10.8	10.8	13.0	13.0	13.0	15.0	15.0	15.0	15.0	15.0	15.0
Installation torque	$T_{inst} =$ [Nm]	10	10	15	15	25	25	25	25	30	30	30
Diameter of clearance hole in the fixture												
Pre-setting installation	$d_f \leq$ [mm]	9	9	12	12	14	14	14	14	14	14	14
Through-setting installation ¹⁾	$d_f \leq$ [mm]	-	-	14	14	14 ^{2)/16}	16	16	16	16	16	16

¹⁾ After the installation the annular gap in the clearance hole in the fixture has to be filled completely by excess mortar.

²⁾ If hole diameter in the fixture $d_f \leq 14$ mm, annular gap does not have to be filled by mortar (see Annex 7).

Table 4b: Installation parameters M16 – M24

Anchor size		90 M16	105 M16	125 M16	145 M16	115 M20	170 M20 (LG)	190 M20 (LG)	170 M24 (LG)	200 M24 (LG)	225 M24 (LG)
Effective anchorage depth	$h_{ef} =$ [mm]	90	105	125	145	115	170	190	170	200	225
Nominal diameter of drill hole	$d_0 =$ [mm]	18	18	18	18	22	24	24	26	26	26
Depth of drill hole	$h_0 \geq$ [mm]	98	113	133	153	120	180	200	185	215	240
Diameter of steel brush	$D \geq$ [mm]	19.0	19.0	19.0	19.0	23.0	25.0	25.0	27.0	27.0	27.0
Installation torque	$T_{inst} =$ [Nm]	50	50	50	50	80	80	80	100	120	120
Diameter of clearance hole in the fixture											
Pre-setting installation	$d_f \leq$ [mm]	18	18	18	18	22	24 (22)	24 (22)	26	26	26
Through-setting installation ¹⁾	$d_f \leq$ [mm]	20	20	20	20	24	26	26	28	28	28

¹⁾ After the installation the annular gap in the clearance hole in the fixture has to be filled completely by excess mortar.

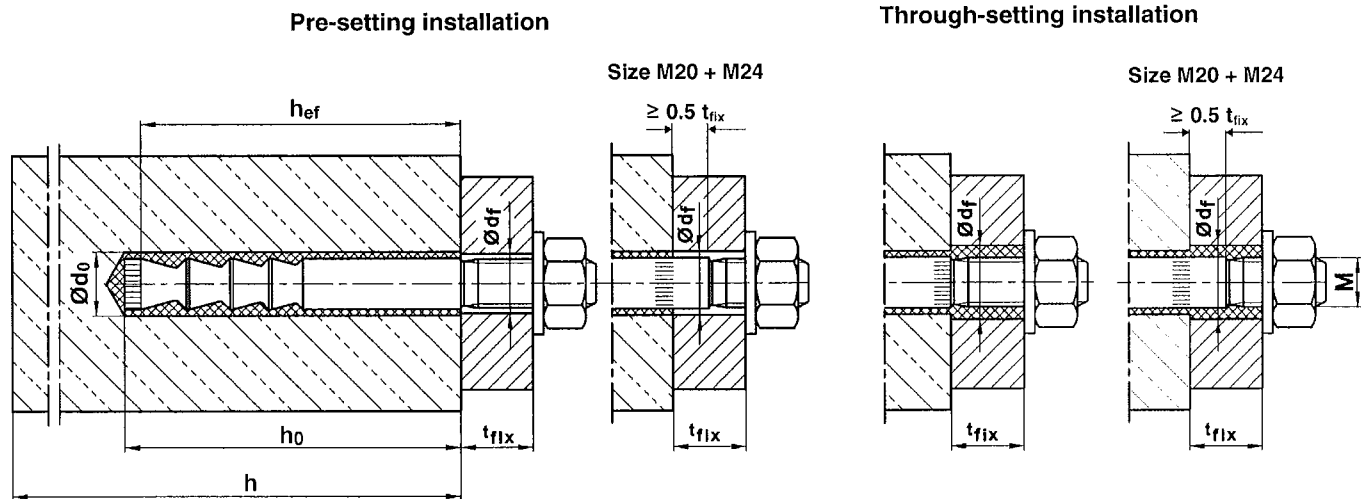

ATRION Injection System AVM-BGZ / -R / -HCR



**Installation conditions,
Installation parameters**

Annex 4

of European
technical Approval

ETA-04/0116

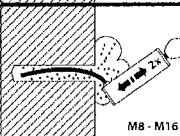
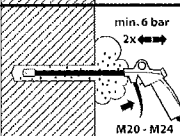
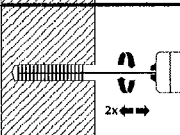
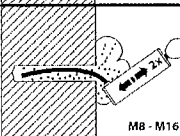
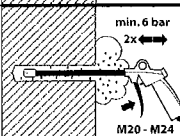
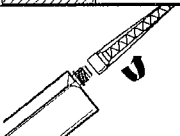
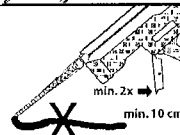
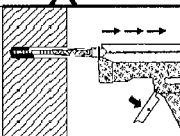
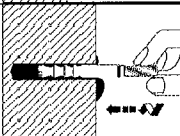
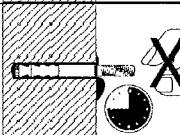
Pre-setting installation instructions

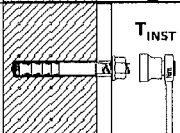
1		<p>Use Hammer drill or air drill with drill bit and depth gauge. Drill perpendicular to concrete surface.</p>
<p>Drill hole must be cleaned directly prior to installation of the anchor.</p>		
2a		<p>AVM-BGZ M8 - M16: Blow out drill hole from the bottom with ATRION Blow-out pump AVM-HAB at least two times. The Extension Tube with reduced diameter must be added to the Blow-out pump for the diameter M8.</p>
2b		<p>AVM-BGZ M20 - M24: Connect ATRION Air Blower AVM-DAB to compressed air (min. 6 bar, oil-free). Open air valve and blow out drill hole along the entire depth with back and forth motion at least two times.</p>
3		<p>Check diameter of ATRION Wire Brush SB. If Wire Brush can be pushed into the drill hole without any resistance, it must be replaced. Chuck Brush into drill machine. Turn on drill machine. Brush drill hole back and forth along the entire drill hole depth at least two times while rotated by drill machine.</p>
4a		<p>AVM-BGZ M8 - M16: Blow out drill hole from the bottom with ATRION Blow-out pump AVM-HAB at least two times. The Extension Tube with reduced diameter must be added to the Blow-out pump for the diameter M8.</p>
4b		<p>AVM-BGZ M20 - M24: Connect ATRION Air Blower AVM-DAB to compressed air (min. 6 bar, oil-free). Open air valve and blow out drill hole along the entire depth with back and forth motion at least two times.</p>
5		<p>Check expiration date on AVM-BGZ cartridge. Never use when expired. Remove cap from AVM-BGZ cartridge. Screw Mixer Nozzle SM on cartridge. When using a new cartridge always use a new Mixer Nozzle. Never use cartridge without Mixer Nozzle and never use Mixer Nozzle without helix inside.</p>
6		<p>Insert cartridge in Dispenser. Before injecting discard mortar (at least 2 full strokes or a line of 10 cm) until it shows a consistent grey colour. Never use this mortar.</p>
7		<p>Prior to injection check if Mixer Nozzle SM reaches the bottom of the drill hole. If it does not reach the bottom, plug Mixer Extension VS onto Mixer Nozzle in order to properly fill the drill hole. Fill cleaned drill hole with a sufficient quantity of injection mortar. Start from the bottom of the drill hole and work out to avoid trapping air pockets.</p>
8		<p>Insert the anchor rod by hand, rotating slightly up to the full embedment depth as marked on the anchor rod. The anchor rod is properly set when excess mortar seeps from the hole. If the hole is not completely filled, pull out anchor rod, let mortar cure, drill out hole and start again from No. 2.</p>
9		<p>Follow minimum curing time shown in Table 5. During curing time anchor rod must not be moved or loaded.</p>
10		<p>Remove excess mortar.</p>
11		<p>The fixture can be mounted after curing time. Apply installation torque T_{inst} according to Table 4a or 4b by using torque wrench.</p>

ATRION Injection System AVM-BGZ / -R / -HCR

**Installation instructions
Pre-setting installation**

Annex 5

of European
technical Approval

ETA-04/0116

Through-setting installation instructions

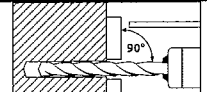
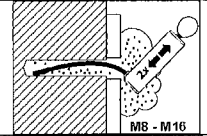
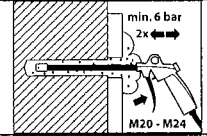
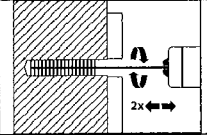
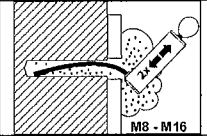
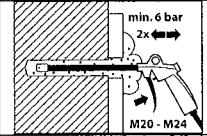
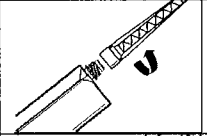
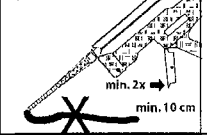
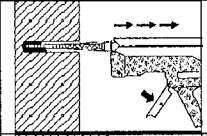
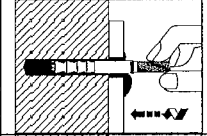
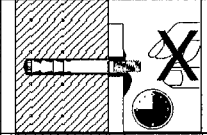
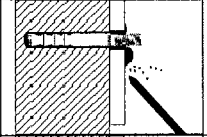
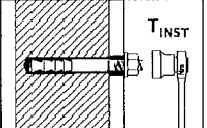
1		<p>Use Hammer drill or air drill with drill bit and depth gauge. Drill perpendicular to concrete surface.</p>
<p>Drill hole must be cleaned directly prior to installation of the anchor.</p>		
2a		<p>AVM-BGZ M8 - M16: Blow out drill hole from the bottom with ATRION Blow-out pump AVM-HAB at least two times. The Extension Tube with reduced diameter must be added to the Blow-out pump for the diameter M8.</p>
2b		<p>AVM-BGZ M20 - M24: Connect ATRION Air Blower AVM-DAB to compressed air (min. 6 bar, oil-free). Open air valve and blow out drill hole along the entire depth with back and forth motion at least two times.</p>
3		<p>Check diameter of ATRION Wire Brush SB. If Wire Brush can be pushed into the drill hole without any resistance, it must be replaced. Chuck Brush into drill machine. Turn on drill machine. Brush drill hole back and forth along the entire drill hole depth at least two times while rotated by drill machine.</p>
4a		<p>AVM-BGZ M8 - M16: Blow out drill hole from the bottom with ATRION Blow-out pump AVM-HAB at least two times. The Extension Tube with reduced diameter must be added to the Blow-out pump for the diameter M8.</p>
4b		<p>AVM-BGZ M20 - M24: Connect ATRION Air blower AVM-DAB to compressed air (min. 6 bar, oil-free). Open air valve and blow out drill hole along the entire depth with back and forth motion at least two times.</p>
5		<p>Check expiration date on AVM-BGZ cartridge. Never use when expired. Remove cap from AVM-BGZ cartridge. Check Mixer Nozzle SM if helix is inside. Screw Mixer Nozzle SM on cartridge. When using a new cartridge always use a new Mixer Nozzle. Never use cartridge without Mixer Nozzle and never use Mixer Nozzle without helix inside.</p>
6		<p>Insert cartridge in Dispenser. Before injecting discard mortar (at least 2 full strokes or a line of 10 cm) until it shows a consistent grey color. Never use this mortar.</p>
7		<p>Prior to injection check if Mixer Nozzle SM reaches the bottom of the drill hole. If it does not reach the bottom, plug Mixer Extension VS onto Mixer Nozzle in order to properly fill the drill hole. Fill cleaned drill hole with a sufficient quantity of injection mortar. Start from the bottom of the drill hole and work out to avoid trapping air pockets.</p>
8		<p>Insert the anchor rod by hand, rotating slightly up to the full embedment depth. After the installation the annular gap in the clearance hole in the fixture has to be filled completely by excess mortar. If the hole is not completely filled, pull out anchor rod, let mortar cure, drill out hole and start again from No. 2.</p>
9		<p>This must be completed within the processing time shown in Table 5. During curing time anchor rod must not be moved or loaded.</p>
10		<p>Remove excess mortar.</p>
11		<p>The washer and the nut can be mounted after curing time. Apply installation torque T_{inst} according to Table 4a or 4b by using torque wrench.</p>

ATRION Injection System AVM-BGZ / -R / -HCR

Installation instructions
Through-setting installation

Annex 6

of European
technical Approval

ETA-04/0116

Installation instructions VMZ 75 M12
Through-setting installation with clearance between concrete and anchor plate

Work step 1-7 as displayed in Annex 6

Requirement: Diameter of clearance hole in the fixture $d_f \leq 14$ mm

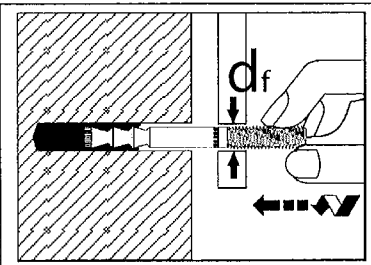
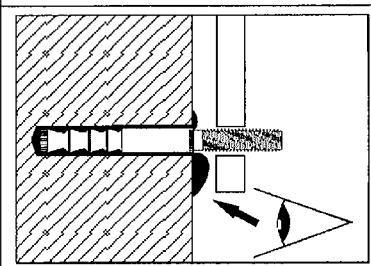
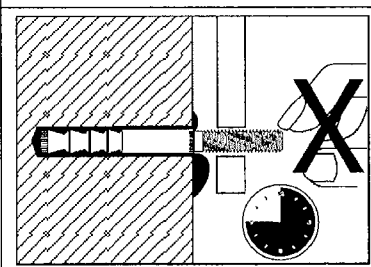
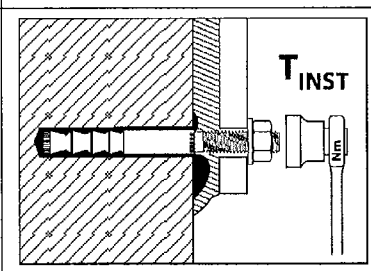
8		<p>Insert the anchor rod by hand, rotating slightly up to the full embedment depth.</p>
9		<p>Check if excess mortar seeps from the hole. If the hole is not completely filled, pull out anchor rod, let mortar cure, drill out hole and start again from No. 2.</p> <p>The annular gap in the fixture does not have to be filled.</p>
10		<p>During curing time as per Table 5 anchor rod must not be moved or loaded.</p>
11		<p>Washer and nut can be mounted after curing time and backfilling of anchor plate. Apply installation torque T_{inst} according to Table 4a by using torque wrench.</p>

ATRION Injection System AVM-BGZ / -R / -HCR

Installation instructions VMZ 75 M12
Through-setting installation with clearance between
concrete and anchor plate

Anhang 7

der europäischen
 technischen Zulassung

ETA-04/0116

Table 5: Maximum processing time and minimum curing time

Temperature [°C] in the drill hole	Maximum processing time	Minimum curing time	
		dry concrete	wet concrete
+ 40 °C	1.4 min	15 min	30 min
+ 35 °C	2 min	20 min	40 min
+ 30 °C	4 min	25 min	50 min
+ 20 °C	6 min	45 min	1:30 h
+ 10 °C	12 min	1:20 h	2:40 h
+ 5 °C	20 min	2:00 h	4:00 h
0 °C	45 min	3:00 h	6:00 h
- 5 °C	1:30 h	6:00 h	12:00 h

Table 6a: Minimum thickness of concrete, minimum spacing and edge distance M8 – M12

Anchor size			40 M8	50 M8	60 M10	75 M10	75 M12	70 M12	80 M12	95 M12	100 M12	110 M12	125 M12
Minimum thickness of concrete	h_{min}	[mm]	80	80	100	110 100 ¹⁾	110	110	110	130 125 ¹⁾	130	140	160
Cracked concrete													
Minimum spacing	s_{min}	[mm]	40	40	40	40	50	55	40	40	50	50	50
Minimum edge distance	c_{min}	[mm]	40	40	40	40	50	55	50	50	50	50	50
Non-cracked concrete													
Minimum spacing	s_{min}	[mm]	40	40	50	50	50	55	55	55	80 ²⁾	80 ²⁾	80 ²⁾
Minimum edge distance	c_{min}	[mm]	40	40	50	50	50	55	55	55	55 ²⁾	55 ²⁾	55 ²⁾

Table 6b: Minimum thickness of concrete, minimum spacing and edge distance M16 – M24

Anchor size			90 M16	105 M16	125 M16	145 M16	115 M20	170 M20 (LG)	190 M20 (LG)	170 M24 (LG)	200 M24 (LG)	225 M24 (LG)
Minimum thickness of concrete	h_{min}	[mm]	130	150	170 160 ¹⁾	190 180 ¹⁾	160	230 220 ¹⁾	250 240 ¹⁾	230 220 ¹⁾	270 260 ¹⁾	300 290 ¹⁾
Cracked concrete												
Minimum spacing	s_{min}	[mm]	50	50	60	60	80	80	80	80	80	80
Minimum edge distance	c_{min}	[mm]	50	50	60	60	80	80	80	80	80	80
Non-cracked concrete												
Minimum spacing	s_{min}	[mm]	50	60	60	60	80	80	80	80	105	105
Minimum edge distance	c_{min}	[mm]	50	60	60	60	80	80	80	80	105	105

¹⁾ The remote face of the concrete member shall be inspected to ensure there has been no break-through by drilling. In case of break-through the ground of the drill hole shall be closed with high strength mortar. The full bonded length h_{ef} shall be achieved and any potential loss of injection mortar shall be compensated.

²⁾ For an edge distance $c \geq 80$ mm a minimum spacing $s_{min} = 55$ mm is applicable.

ATRION Injection System AVM-BGZ / -R / -HCR

**Processing time, curing time,
Minimum thickness of concrete,
Minimum spacing and edge distance**

Annex 8

of European
technical Approval

ETA-04/0116

**Table 7a: Design method A,
Characteristic values for tension loads, M8 – M12**

Anchor size			40 M8	50 M8	60 M10	75 M10	75 M12	70 M12	80 M12	95 M12	100 M12	110 M12	125 M12	
Steel failure														
Characteristic ten- sion resistance $N_{Rk,s}$	Steel, zinc plated	[kN]	15	18	25	25	35	49	54	54	57	57	57	
	Stainless steel A4, HCR	[kN]	15	18	25	25	35	49	54	54	57	57	57	
Partial safety factor γ_{Ms} ⁴⁾		-	1.5											
Pullout and splitting for standard thickness of concrete														
Standard thickness of concrete $h_{std} \geq 2 h_{ef}$		[mm]	100	100	120	150	150	140	160	190	200	220	250	
Characteristic resistance $N_{Rk,p}$ in cracked concrete C20/25	$50^\circ C^2)/80^\circ C^3)$	[kN]	1)											
	$72^\circ C^2)/120^\circ C^3)$	[kN]	5	7.5	12	12	12	16	20	20	30	30	30	
Characteristic resistance $N_{Rk,p}$ in non-cracked concrete	$50^\circ C^2)/80^\circ C^3)$	[kN]	7.5	9	16	20	20	20	1)	30	40	40	40	
	$72^\circ C^2)/120^\circ C^3)$	[kN]	6	9	16	16	16	16	25	25	30	30	30	
C20/25 with $c_{cr,sp} = 1.5 h_{ef}$		$c_{cr,sp}$	1.5 h_{ef}											
Characteristic resistance $N_{Rk,p}$ in non-cracked concrete	$50^\circ C^2)/80^\circ C^3)$	[kN]	9	1)							40	1)	50	50
	$c_{cr,sp}$	[mm]	3 h_{ef}	2.5 h_{ef}	3.5 h_{ef}	3.5 h_{ef}	3.5 h_{ef}	2.5 h_{ef}	1.5 h_{ef}	2.5 h_{ef}	2 h_{ef}	3.0 h_{ef}	2.5 h_{ef}	
Partial safety factor γ_{Mc} ^{4) 5)}		-	1.5											
Pullout and splitting for minimum thickness of concrete														
Minimum thickness of concrete $h_{min} \geq$		[mm]	80	80	100	100	110	110	110	125	130	140	160	
Characteristic resistance $N_{Rk,p}$ in cracked concrete C20/25	$50^\circ C^2)/80^\circ C^3)$	[kN]	1)											
	$72^\circ C^2)/120^\circ C^3)$	[kN]	5	7.5	12	12	12	16	20	20	30	30	30	
Characteristic resistance $N_{Rk,p}$ in non-cracked concrete	$50^\circ C^2)/80^\circ C^3)$	[kN]	7.5	-	16	16	16	20	25	25	30	30	30	
	$72^\circ C^2)/120^\circ C^3)$	[kN]	-	-	16	16	16	16	25	25	30	30	30	
C20/25 with $c_{cr,sp} = 1.5 h_{ef}$		$c_{cr,sp}$	1.5 h_{ef}											
Characteristic resistance $N_{Rk,p}$ in non-cracked concrete	$50^\circ C^2)/80^\circ C^3)$	[kN]	9	1)							40	1)	50	50
	$c_{cr,sp}$	[mm]	3.0 h_{ef}	3.5 h_{ef}	3.0 h_{ef}	3.5 h_{ef}	3.5 h_{ef}	3.5 h_{ef}	3.0 h_{ef}	3.5 h_{ef}	3.0 h_{ef}	3.0 h_{ef}	3.0 h_{ef}	
Partial safety factor γ_{Mc} ^{4) 5)}		-	1.5											
Concrete cone failure														
Effective anchorage depth h_{ef}		[mm]	40	50	60	75	75	70	80	95	100	110	125	
Spacing $s_{cr,N}$		[mm]	3 h_{ef}											
Edge distance $c_{cr,N}$		[mm]	1.5 h_{ef}											
Partial safety factor γ_{Mc} ⁴⁾		-	1.5											
Increasing factors for $N_{Rk,p}$ ψ_C	C25/30	-	1.10											
	C30/37	-	1.22											
	C40/50	-	1.41											
	C45/55	-	1.48											
	C50/60	-	1.55											

1) Pullout failure is not decisive

3) Maximum short term temperature

5) The partial safety factor $\gamma_2 = 1.0$ is included

2) Maximum long term temperature

4) In absence of other national regulations

Table 8a: Displacements under tension loads M8 – M12

Anchor size			40 M8	50 M8	60 M10	75 M10	75 M12	70 M12	80 M12	95 M12	100 M12	110 M12	125 M12
Tension load in cracked concrete		N [kN]	4.3	6.1	8.0	11.1	11.1	10.0	12.3	15.9	17.1	19.8	24.0
Displacement	δ_{N0}	[mm]	0.5	0.5	0.5	0.6	0.6	0.6	0.6	0.6	0.6	0.7	0.7
	$\delta_{N\infty}$	[mm]	1.3										
Tension load in non-cracked concrete		N [kN]	4.3	8.5	11.1	15.6	15.6	14.1	17.2	19.0	24.0	23.8	23.8
Displacement	δ_{N0}	[mm]	0.2	0.4	0.4	0.4	0.4	0.4	0.4	0.4	0.4	0.6	0.6
	$\delta_{N\infty}$	[mm]	1.3										

ATRION Injection System AVM-BGZ / -R / -HCR**Design method A,
Characteristic values for tension loads, M8 - M12,
Displacements****Annex 9**of European
technical Approval**ETA-04/0116**

**Table 7b: Design method A,
Characteristic values for tension loads, M16 – M24**

Anchor size			90 M16	105 M16	125 M16	145 M16	115 M20	170 M20 (LG)	190 M20 (LG)	170 M24 (LG)	200 M24 (LG)	225 M24 (LG)	
Steel failure													
Characteristic tension resistance $N_{Rk,s}$	Steel, zinc plated	[kN]	88	95	111	111	96	188	188	222	222	222	
	Stainless steel A4, HCR	[kN]	88	95	111	111	114	165	165	194	194	194	
Partial safety factor γ_{Ms} ⁴⁾		-	1.5				1.68	1.5					
Pullout and splitting for standard thickness of concrete													
Standard thickness of concrete $h_{std} \geq 2 h_{ef}$		[mm]	180	200	250	290	230	340	380	340	400	450	
Characteristic resistance $N_{Rk,p}$ in cracked concrete C20/25	$50^\circ C^2)/80^\circ C^3)$	[kN]	1)										
	$72^\circ C^2)/120^\circ C^3)$	[kN]	25	30	50	50	30	60	60	75	75	75	
Characteristic resistance $N_{Rk,p}$ in non-cracked concrete C20/25 with $c_{cr,sp} = 1.5 h_{ef}$	$50^\circ C^2)/80^\circ C^3)$	[kN]	40	50	50	60	1)		115	1)			140
	$72^\circ C^2)/120^\circ C^3)$	[kN]	25	35	50	50	40	75	75	95	95	95	
$c_{cr,sp}$		[mm]	1.5 h_{ef}										
Characteristic resistance $N_{Rk,p}$ in non-cracked concrete C20/25	$50^\circ C^2)/80^\circ C^3)$	[kN]	1)			75	1)						
	$c_{cr,sp}$	[mm]	2 h_{ef}	2 h_{ef}	2 h_{ef}	2 h_{ef}	1.5 h_{ef}	1.5 h_{ef}	2 h_{ef}	1.5 h_{ef}	1.5 h_{ef}	1.8 h_{ef}	
Partial safety factor γ_{Mc} ^{4) 5)}		-	1.5										
Pullout and splitting for minimum thickness of concrete													
Minimum thickness of concrete $h_{min} \geq$		[mm]	130	150	160	180	160	220	240	220	260	290	
Characteristic resistance $N_{Rk,p}$ in cracked concrete C20/25	$50^\circ C^2)/80^\circ C^3)$	[kN]	1)										
	$72^\circ C^2)/120^\circ C^3)$	[kN]	20	30	50	50	30	60	60	75	75	75	
Characteristic resistance $N_{Rk,p}$ in non-cracked concrete C20/25 with $c_{cr,sp} = 1.5 h_{ef}$	$50^\circ C^2)/80^\circ C^3)$	[kN]	35	50	40	50	-	75	75	1)	115	115	
	$72^\circ C^2)/120^\circ C^3)$	[kN]	25	35	40 (50) ⁶⁾	50	-	75	75	95	95	95	
$c_{cr,sp}$		[mm]	1.5 h_{ef}										
Characteristic resistance $N_{Rk,p}$ in non-cracked concrete C20/25	$50^\circ C^2)/80^\circ C^3)$	[kN]	1)			75	1)						
	$c_{cr,sp}$	[mm]	2.5 h_{ef}	2.5 h_{ef}	3.0 h_{ef}	2.5 h_{ef}	2.5 h_{ef}	2.6 h_{ef}	2.2 h_{ef}	2.6 h_{ef}	2.2 h_{ef}	2.2 h_{ef}	
Partial safety factor γ_{Mc} ^{4) 5)}		-	1.5										
Concrete cone failure													
Effective anchorage depth h_{ef}		[mm]	90	105	125	145	115	170	190	170	200	225	
Spacing $s_{cr,N}$		[mm]	3 h_{ef}										
Edge distance $c_{cr,N}$		[mm]	1.5 h_{ef}										
Partial safety factor γ_{Mc} ⁴⁾		-	1.5										
Increasing factors for $N_{Rk,p}$	ψ_C	-	1.10										
		-	1.22										
		-	1.41										
		-	1.48										
		-	1.55										

1) Pullout failure is not decisive

3) Maximum short term temperature

5) The partial safety factor $\gamma_2 = 1.0$ is included

2) Maximum long term temperature

4) In absence of other national regulations

6) Applies only if $c_{cr,sp} \geq 3 h_{ef}$ **Table 8b: Displacements under tension loads M16 – M24**

Anchor size			90 M16	105 M16	125 M16	145 M16	115 M20	170 M20 (LG)	190 M20 (LG)	170 M24 (LG)	200 M24 (LG)	225 M24 (LG)	
Tension load in cracked concrete		N	[kN]	14.6	18.4	24.0	30.0	21.1	38.0	44.9	38.0	48.5	57.9
Displacement	δ_{N0}	[mm]	0.7	0.7	0.7	0.8	0.7	0.8	0.8	0.8	0.9	0.9	
	$\delta_{N\infty}$	[mm]	1.3				1.1	1.3					
Tension load in non-cracked concrete		N	[kN]	20.5	25.9	33.0	35.7	29.6	53.3	63.0	53.3	67.9	81.1
Displacement	δ_{N0}	[mm]	0.6	0.6	0.6	0.6	0.5	0.6	0.6	0.6	0.6	0.6	
	$\delta_{N\infty}$	[mm]	1.3				1.1	1.3					

ATRION Injection System AVM-BGZ / -R / -HCR**Design method A,
Characteristic values for tension loads, M16 - M24,
Displacements****Annex 10**of European
technical Approval**ETA-04/0116**

**Table 9a: Design method A,
Characteristic values for shear loads, M8 – M12**

Anchor size			40 M8	50 M8	60 M10	75 M10	75 M12	70 M12	80 M12	95 M12	100 M12	110 M12	125 M12
Steel failure without lever arm													
Characteristic shear resistance $V_{Rk,s}$	Zinc plated steel	[kN]	14	14	21	21	34	34	34	34	34	34	34
	Stainless steel A4, HCR	[kN]	15	15	23	23	34	34	34	34	34	34	34
Partial safety factor	γ_{Ms} ¹⁾	-	1.25										
Steel failure with lever arm													
Characteristic bending moments $M^0_{Rk,s}$	Zinc plated steel	[Nm]	30	30	60	60	105	105	105	105	105	105	105
	Stainless steel A4, HCR	[Nm]	30	30	60	60	105	105	105	105	105	105	105
Partial safety factor	γ_{Ms} ¹⁾	-	1.25										
Concrete pryout failure													
Factor in equation (5.6) ETAG Annex C, 5.2.3.3	k	-	2										
Partial safety factor	γ_{Mcp} ¹⁾	-	1.5 ²⁾										
Concrete edge failure													
Effective length of anchor in shear load	l_f	[mm]	40	50	60	75	75	70	80	95	100	110	112
Diameter of anchor	d_{nom}	[mm]	10	10	12	12	12	14	14	14	14	14	14
Partial safety factor	γ_{Mc} ¹⁾	-	1.5 ²⁾										

¹⁾ In absence of other national regulations

²⁾ The partial safety factor $\gamma_2 = 1.0$ is included

Table 10a: Displacements under shear loads M8 – M12

Anchor size			40 M8	50 M8	60 M10	75 M10	75 M12	70 M12	80 M12	95 M12	100 M12	110 M12	125 M12
Shear load in non-cracked concrete	V	[kN]	8.3	8.3	13.3	13.3	19.3	19.3	19.3	19.3	19.3	19.3	19.3
Displacements	δ_{V0}	[mm]	2.4	2.5	2.9	2.9	3.3	3.3	3.3	3.3	3.3	3.3	3.3
	$\delta_{V\infty}$	[mm]	3.6	3.8	4.4	4.4	5.0	5.0	5.0	5.0	5.0	5.0	5.0

ATRION Injection System AVM-BGZ / -R / -HCR

**Design method A,
Characteristic values for to shear loads, M8 - M12,
Displacements**

Annex 11

of European
technical Approval

ETA-04/0116

**Table 9b: Design method A,
Characteristic values for shear loads, M16 – M24**

Anchor size			90 M16	105 M16	125 M16	145 M16	115 M20	170 M20 (LG)	190 M20 (LG)	170 M24 (LG)	200 M24 (LG)	225 M24 (LG)
Steel failure without lever arm												
Characteristic shear resistance $V_{Rk,s}$	Zinc plated steel	[kN]	63	63	63	63	70	149 ²⁾ (98)	149 ²⁾ (98)	178 ²⁾ (141)	178 ²⁾ (141)	178 ²⁾ (141)
	Stainless steel A4, HCR	[kN]	63	63	63	63	86	131 ²⁾ (86)	131 ²⁾ (86)	156 ²⁾ (123)	156 ²⁾ (123)	156 ²⁾ (123)
Partial safety factor	γ_{Ms} ¹⁾	-	1.25				1.4	1.25				
Steel failure with lever arm												
Characteristic bending moments $M_{Rk,s}^0$	Zinc plated steel	[Nm]	266	266	266	266	392	519	519	896	896	896
	Stainless steel A4, HCR	[Nm]	266	266	266	266	454	454	454	784	784	784
Partial safety factor	γ_{Ms} ¹⁾	-	1.25				1.4	1.25				
Concrete pryout failure												
Factor in equation (5.6) ETAG Annex C, 5.2.3.3	k	-	2									
Partial safety factor	γ_{Mcp} ¹⁾	-	1.5 ³⁾									
Concrete edge failure												
Effective length of anchor in shear load	l_t	[mm]	90	105	125	144	115	170	190	170	200	208
Diameter of anchor	d_{nom}	[mm]	18	18	18	18	22	24	24	26	26	26
Partial safety factor	γ_{Mc} ¹⁾	-	1.5 ³⁾									

¹⁾ In absence of other national regulations

²⁾ This values may only be applied if $l_t \geq 0.5 t_{fix}$ is ensured

³⁾ The partial safety factor $\gamma_2 = 1.0$ is included

Size M20 + M24

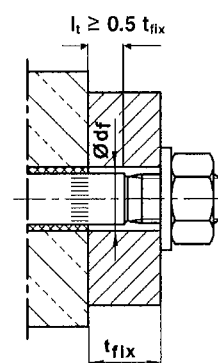
**Table 10b: Displacements under shear loads M16 – M24**

Anchor size			90 M16	105 M16	125 M16	145 M16	115 M20	170 M20 (LG)	190 M20 (LG)	170 M24 (LG)	200 M24 (LG)	225 M24 (LG)
Shear load in non-cracked concrete	V	[kN]	36	36	36	36	44	75 (49)	75 (49)	89 (71)	89 (71)	89 (71)
Displacements	δ_{v0}	[mm]	3.8	3.8	3.8	3.8	3.0	4.3 (3.0)	4.3 (3.0)	4.6 (3.5)	4.6 (3.5)	4.6 (3.5)
	$\delta_{v\infty}$	[mm]	5.7	5.7	5.7	5.7	4.5	6.5 (4.5)	6.5 (4.5)	6.9 (5.3)	6.9 (5.3)	6.9 (5.3)

ATRION Injection System AVM-BGZ / -R / -HCR

**Design method A,
Characteristic values for shear loads, M16 – M24,
Displacements**

Annex 12

of European
technical Approval

ETA-04/0116