

Deutsches Institut für Bautechnik

Anstalt des öffentlichen Rechts

Kolonnenstr. 30 L
10829 Berlin
Germany

Tel.: +49(0)30 787 30 0
Fax: +49(0)30 787 30 320
E-mail: dibt@dibt.de
Internet: www.dibt.de

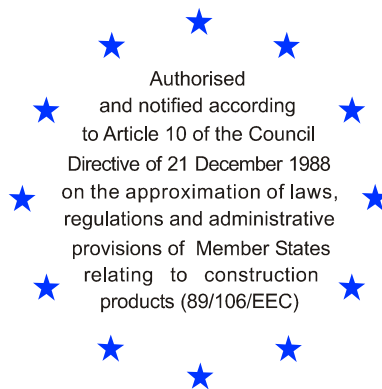

DIBt

Mitglied der EOTA
Member of EOTA

European Technical Approval ETA-04/0025

English translation prepared by DIBt - Original version in German language

Handelsbezeichnung <i>Trade name</i>	WAKAI Deckendübel <i>WAKAI Ceiling Fastening Anchor</i>
Zulassungsinhaber <i>Holder of approval</i>	WAKAI GmbH Mainzer Landstraße 49 60329 Frankfurt am Main DEUTSCHLAND
Zulassungsgegenstand und Verwendungszweck <i>Generic type and use of construction product</i>	Dübel aus galvanisch verzinktem Stahl für die Verwendung als Mehrfachbefestigung von nichttragenden Systemen in Beton <i>Anchor made of galvanised steel for multiple use for non-structural applications in concrete</i>
Geltungsdauer: <i>Validity:</i>	vom <i>from</i> 1 March 2010 bis <i>to</i> 10 May 2014
Herstellwerk <i>Manufacturing plant</i>	WAKAI Werk 2

Diese Zulassung umfasst
This Approval contains

10 Seiten einschließlich 3 Anhänge
10 pages including 3 annexes

Diese Zulassung ersetzt
This Approval replaces

ETA-04/0025 mit Geltungsdauer vom 07.05.2009 bis 10.05.2014
ETA-04/0025 with validity from 07.05.2009 to 10.05.2014



Europäische Organisation für Technische Zulassungen
European Organisation for Technical Approvals

I LEGAL BASES AND GENERAL CONDITIONS

- 1 This European technical approval is issued by Deutsches Institut für Bautechnik in accordance with:
 - Council Directive 89/106/EEC of 21 December 1988 on the approximation of laws, regulations and administrative provisions of Member States relating to construction products¹, modified by Council Directive 93/68/EEC² and Regulation (EC) N° 1882/2003 of the European Parliament and of the Council³;
 - Gesetz über das In-Verkehr-Bringen von und den freien Warenverkehr mit Bauprodukten zur Umsetzung der Richtlinie 89/106/EWG des Rates vom 21. Dezember 1988 zur Angleichung der Rechts- und Verwaltungsvorschriften der Mitgliedstaaten über Bauprodukte und anderer Rechtsakte der Europäischen Gemeinschaften (Bauproduktengesetz - BauPG) vom 28. April 1998⁴, as amended by law of 31 October 2006⁵;
 - Common Procedural Rules for Requesting, Preparing and the Granting of European technical approvals set out in the Annex to Commission Decision 94/23/EC⁶;
 - Guideline for European technical approval of "Metal anchors for use in concrete - Part 6: Anchors for multiple use for non-structural applications", ETAG 001-06.
- 2 Deutsches Institut für Bautechnik is authorized to check whether the provisions of this European technical approval are met. Checking may take place in the manufacturing plant. Nevertheless, the responsibility for the conformity of the products to the European technical approval and for their fitness for the intended use remains with the holder of the European technical approval.
- 3 This European technical approval is not to be transferred to manufacturers or agents of manufacturers other than those indicated on page 1, or manufacturing plants other than those indicated on page 1 of this European technical approval.
- 4 This European technical approval may be withdrawn by Deutsches Institut für Bautechnik, in particular pursuant to information by the Commission according to Article 5(1) of Council Directive 89/106/EEC.
- 5 Reproduction of this European technical approval including transmission by electronic means shall be in full. However, partial reproduction can be made with the written consent of Deutsches Institut für Bautechnik. In this case partial reproduction has to be designated as such. Texts and drawings of advertising brochures shall not contradict or misuse the European technical approval.
- 6 The European technical approval is issued by the approval body in its official language. This version corresponds fully to the version circulated within EOTA. Translations into other languages have to be designated as such.

1 Official Journal of the European Communities L 40, 11 February 1989, p. 12

2 Official Journal of the European Communities L 220, 30 August 1993, p. 1

3 Official Journal of the European Union L 284, 31 October 2003, p. 25

4 *Bundesgesetzblatt Teil I 1998*, p. 812

5 *Bundesgesetzblatt Teil I 2006*, p. 2407, 2416

6 Official Journal of the European Communities L 17, 20 January 1994, p. 34

II SPECIFIC CONDITIONS OF THE EUROPEAN TECHNICAL APPROVAL

1 Definition of the construction product and intended use

1.1 Definition of the product

The WAKAI Ceiling Fastening Anchor is an anchor made of galvanised steel which is pushed into a drilled hole and anchored by deformation-controlled expansion.

An illustration of the product and intended use is given in Annex 1.

1.2 Intended use

The anchor is intended to be used for anchorages for which requirements for safety in use in the sense of the Essential Requirements 4 of Council Directive 89/106 EEC shall be fulfilled and failure of the fixture represents an immediate risk to human life. The anchor is to be used only for multiple use for non-structural applications. The definition of multiple use according to the Member States is given in the informative Annex 1 of ETAG 001, Part 6.

The anchor is to be used only for anchorages subject to static or quasi-static loading in reinforced or unreinforced normal weight concrete of strength classes C12/15 at minimum and C50/60 at most according to EN 206-1:2000-12.

It may be anchored in cracked or non-cracked concrete.

The anchor may be used in structures subject to dry internal conditions.

The provisions made in this European technical approval are based on an assumed working life of the anchor of 50 years. The indications given on the working life cannot be interpreted as a guarantee given by the producer, but are to be regarded only as a means for choosing the right products in relation to the expected economically reasonable working life of the works.

2 Characteristics of the product and methods of verification

2.1 Characteristics of the product

The anchor corresponds to the drawings and provisions given in Annex 1. The characteristic material values, dimensions and tolerances of the anchor not given in Annex 1 shall correspond to the respective values laid down in the technical documentation⁷ of this European technical approval.

The characteristic values for the design of anchorages are given in Annex 3.

Each anchor is marked with the identifying mark of the producer including the anchor type according to Annex 2.

The anchor shall only be supplied as a complete unit.

⁷ The technical documentation of this European technical approval is deposited at the Deutsches Institut für Bautechnik and, as far as relevant for the tasks of the approved bodies involved in the attestation of conformity procedure, is handed over to the approved bodies.

2.2 Methods of verification

The assessment of fitness of the anchor for the intended use in relation to the requirements for safety in use in the sense of the Essential Requirements 4 has been made in accordance with the "Guideline for European technical approval of Metal Anchors for use in concrete", Part 1 "Anchors in general" and Part 6 "Anchors for multiple use for non-structural applications".

In addition to the specific clauses relating to dangerous substances contained in this European technical approval, there may be other requirements applicable to the products falling within its scope (e.g. transposed European legislation and national laws, regulations and administrative provisions). In order to meet the provisions of the Construction Products Directive, these requirements need also to be complied with, when and where they apply.

3 Evaluation and attestation of conformity and CE marking

3.1 System of attestation of conformity

According to the decision 97/161/EG of the European Commission⁸ the system 2(ii) (referred to as system 2+) of attestation of conformity applies.

This system of attestation of conformity is defined as follows:

System 2+: Declaration of conformity of the product by the manufacturer on the basis of:

(a) Tasks for the manufacturer:

- (1) initial type-testing of the product;
- (2) factory production control;
- (3) testing of samples taken at the factory in accordance with a prescribed control plan.

(b) Tasks for the approved body:

- (4) certification of factory production control on the basis of:
 - initial inspection of factory and of factory production control;
 - continuous surveillance, assessment and approval of factory production control.

Note: Approved bodies are also referred to as "notified bodies".

3.2 Responsibilities

3.2.1 Tasks for the manufacturer

3.2.1.1 Factory production control

The manufacturer shall exercise permanent internal control of production. All the elements, requirements and provisions adopted by the manufacturer shall be documented in a systematic manner in the form of written policies and procedures, including records of results performed. This production control system shall insure that the product is in conformity with this European technical approval.

The manufacturer may only use initial / raw / constituent materials stated in the technical documentation of this European technical approval.

The factory production control shall be in accordance with the control plan which is part of the technical documentation of this European technical approval. The control plan is laid down in the context of the factory production control system operated by the manufacturer and deposited with Deutsches Institut für Bautechnik.⁹

⁸ Official Journal of the European Communities L 67 of 03.02.1997

⁹ The control plan is a confidential part of the European technical approval and only handed over to the approved body involved in the procedure of attestation of conformity. See section 3.2.2.

The results of factory production control shall be recorded and evaluated in accordance with the provisions of the control plan.

3.2.1.2 Other tasks of manufacturer

The manufacturer shall, on the basis of a contract, involve a body which is approved for the tasks referred to in section 3.1 in the field of anchors in order to undertake the actions laid down in section 3.2.2. For this purpose, the control plan referred to in sections 3.2.1.1 and 3.2.2 shall be handed over by the manufacturer to the approved body involved.

The manufacturer shall make a declaration of conformity, stating that the construction product is in conformity with the provisions of this European technical approval.

3.2.2 Tasks for the approved bodies

The approved body shall perform the

- initial inspection of factory and of factory production control,
 - continuous surveillance, assessment and approval of factory production control,
- in accordance with the provisions laid down in the control plan.

The approved body shall retain the essential points of its actions referred to above and state the results obtained and conclusions drawn in a written report.

The approved certification body involved by the manufacturer shall issue an EC certificate of conformity of the factory production control stating the conformity with the provisions of this European technical approval.

In cases where the provisions of the European technical approval and its control plan are no longer fulfilled the certification body shall withdraw the certificate of conformity and inform Deutsches Institut für Bautechnik without delay.

3.3 CE marking

The CE marking shall be affixed on each packaging of the anchor. The letters "CE" shall be followed by the identification number of the approved certification body, where relevant, and be accompanied by the following additional information:

- the name and address of the producer (legal entity responsible for the manufacture),
- the last two digits of the year in which the CE marking was affixed,
- the number of the EC certificate for the factory production control,
- the number of the European technical approval,
- the number of the guideline for European technical approval (ETAG 001-6),
- size.

4 Assumptions under which the fitness of the product for the intended use was favourably assessed

4.1 Manufacturing

The European technical approval is issued for the product on the basis of agreed data/information, deposited with the Deutsches Institut für Bautechnik, which identifies the product that has been assessed and judged. Changes to the product or production process, which could result in this deposited data/information being incorrect, should be notified to the Deutsches Institut für Bautechnik before the changes are introduced. Deutsches Institut für Bautechnik will decide whether or not such changes affect the approval and consequently the validity of the CE marking on the basis of the approval and if so whether further assessment or alterations to the approval shall be necessary.

4.2 Design of anchorages

The fitness of the anchor for the intended use is given under the following conditions:

- The anchorages are designed in accordance with the "Guideline for European technical approval of Metal Anchors for Use in Concrete", Annex C, Method C under the responsibility of an engineer experienced in anchorages and concrete work.
- The anchor is to be used only for multiple use for non-structural applications, the definition of multiple use according to the Member States is given in the informative Annex 1 of ETAG 001, Part 6.
- Verifiable calculation notes and drawings are prepared taking account of the loads to be anchored.
- The position of the anchor is indicated on the design drawings (e.g. position of the anchor relative to reinforcement or to supports).
- The design of the fixture is such, that in case of excessive slip or failure of one anchor the load can be transmitted to neighbouring anchors.

4.3 Installation of anchors

The fitness for use of the anchor can only be assumed if the anchor is installed as follows:

- Anchor installation carried out by appropriately qualified personnel and under the supervision of the person responsible for technical matters of the site.
- Use of the anchor only as supplied by the manufacturer without exchanging the components of an anchor.
- Anchor installation in accordance with the manufacturer's specifications and drawings and using the appropriate tools.
- Checks before placing the anchor to ensure that the strength class of the concrete in which the anchor is to be placed is in the range given and is not lower than that of the concrete to which the characteristic loads apply.
- Check of concrete being well compacted, e.g. without significant voids.
- Edge distances and spacings not less than the specified values without minus tolerances.
- Positioning of the drill holes without damaging the reinforcement.
- In case of aborted hole: new drilling at a minimum distance away of twice the depth of the aborted hole or smaller distance if the aborted drill hole is filled with high strength mortar and if under shear or oblique tension load it is not in the direction of load application.
- Cleaning of the hole of drilling dust.
- Anchor installation such that the effective setting depth is complied with. This compliance is ensured, if the admissible thickness of fixture is kept.

5 Responsibility of the manufacturer

The manufacturer is responsible to ensure that the information on the specific conditions according to 1 and 2 including Annexes referred to and 4.2 and 4.3 is given to those who are concerned. This information may be made by reproduction of the respective parts of the European technical approval. In addition all installation data shall be shown clearly on the package and/or on an enclosed instruction sheet, preferably using illustration(s).

The minimum data required are:

- drill bit diameter,
- minimum effective anchorage depth,
- minimum hole depth,
- maximum thickness of fixture for the anchor type,
- information on the installation procedure, preferably by means of an illustration,
- reference to any special installation equipment needed,
- identification of the manufacturing batch.

All data shall be presented in a clear and explicit form.

Dipl.-Ing. Georg Feistel
Head of Division Construction Engineering
of Deutsches Institut für Bautechnik
Berlin, 1 March 2010

beglaubigt
Lange

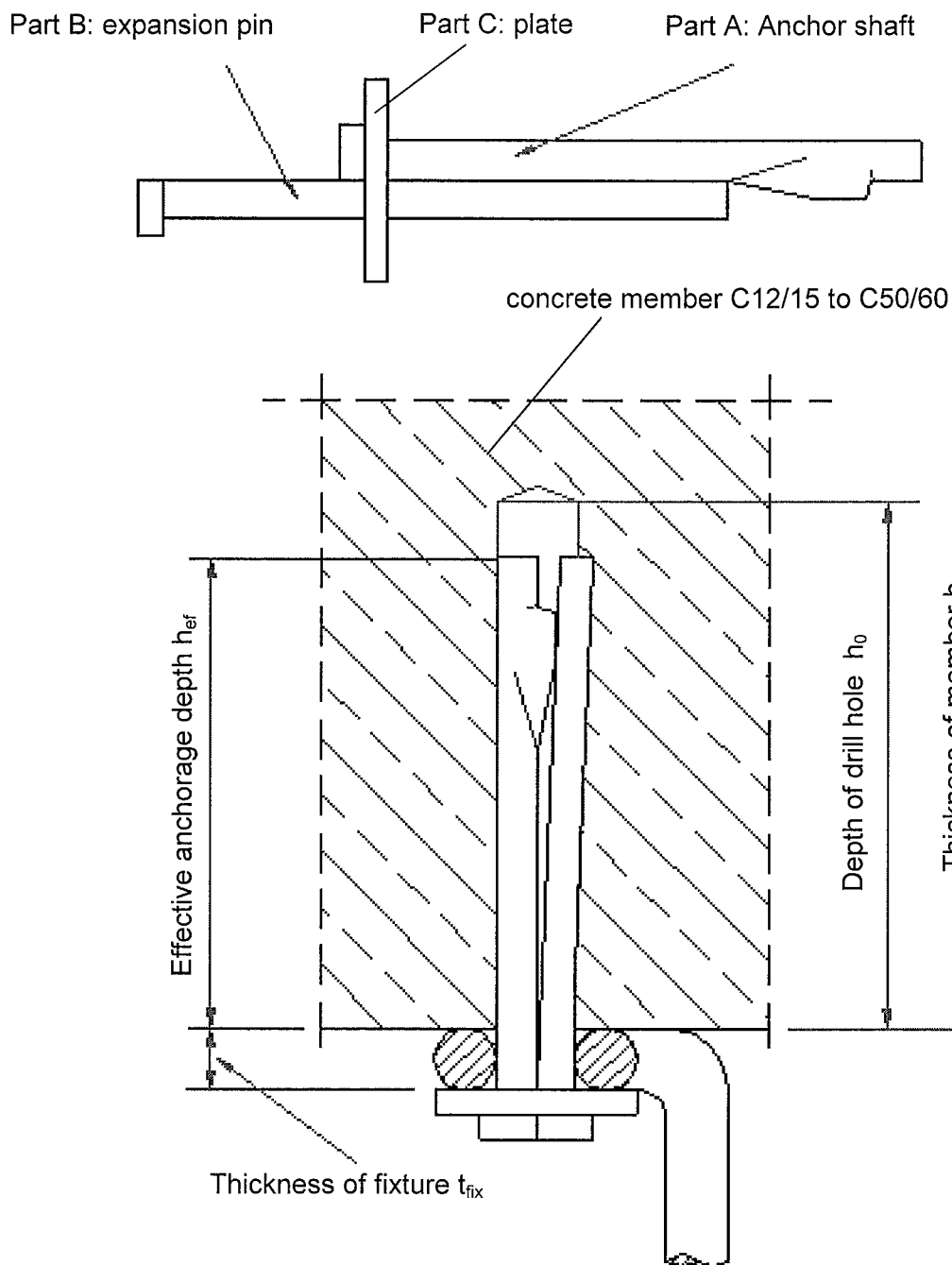

**Multiple use for non-structural applications only
 in accordance with ETAG 001 Part 6 Annex 1**

<p>WAKAI Ceiling Fastening Anchor</p>	<p>Annex 1</p>
<p>Product and intended use</p>	<p>of European technical approval ETA-04/0025</p>

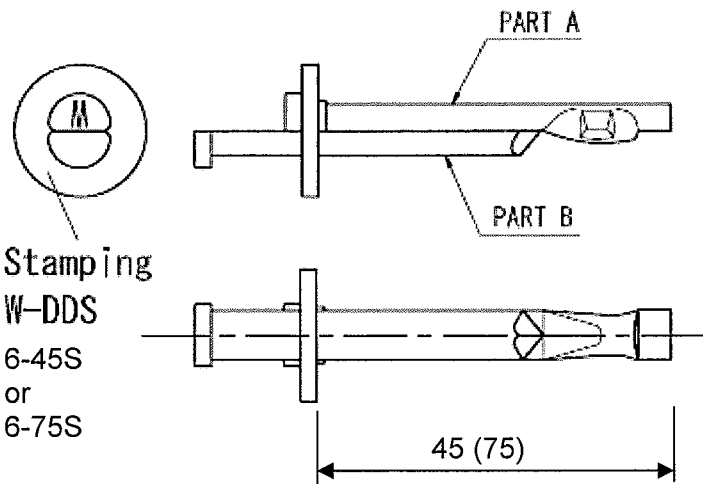
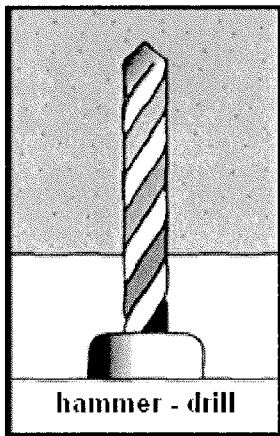

Table 1 Designation and materials

Part	Designation	Material
A	Anchor shaft	Steel acc. to EN 10025 galvanised $\geq 5 \mu\text{m}$ acc to EN ISO 4042
B	Expansion pin	
C	Plate	

Installation Instructions



hammer - drill

Hammer drilling only – keep installation parameters given in Annex 3

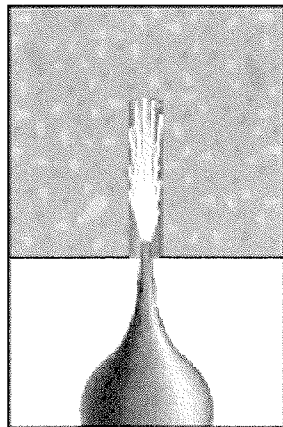

Blow out dust and fragments

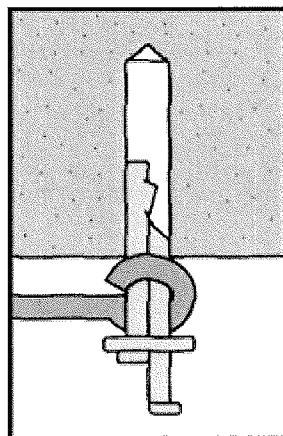

Install the anchor through the fixture into the clean drill hole

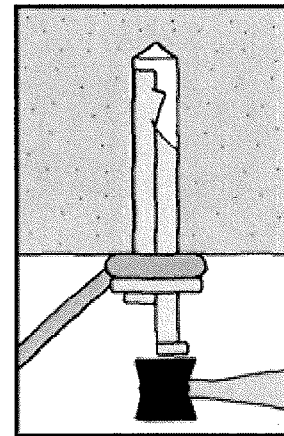

Drive-in Expansion Pin fully by impact with hammer blows

WAKAI Ceiling Fastening Anchor

**Designation of anchor parts
 Dimensions and materials
 Marking / Installation Instructions**

Annex 2

of European technical approval
ETA-04/0025

Table 2 Installation parameters

Anchor size			W-DDS-45	W-DDS-75
Effective anchorage depth	h_{ef}	[mm]	38	
Thickness of fixture	t_{fix}	[mm]	0 ... 5	25 ... 35
Required depth of drill hole	h_0	[mm]	50	
Nominal diameter of drill bit	d_0	[mm]	6	
Maximum cutting diameter of drill bit	$d_{cut} \leq$	[mm]	6,45	
Minimum thickness of member	h_{min}	[mm]	80	
Minimum spacing	s_{cr}	[mm]	200	
Minimum edge distance	c_{cr}	[mm]	150	

Table 3 Design method C: Characteristic values

Anchor size			W-DDS-45	W-DDS-75
Any load direction				
Characteristic resistance in C20/25 to C50/60	F_{Rk}	[kN]	4.0	
Characteristic resistance in C12/15	F_{Rk}	[kN]	3.0	
Partial safety factor (including installation safety factor)	$\gamma_M^{1)}$		1.8 ²⁾	
Shear load with lever arm				
Characteristic bending moment	$M_{Rk,S}^{0\ 3)}$	[Nm]	9.5	
Partial safety factor	γ_{Ms}	-	1,25	

1) In absence of other national regulations

2) The partial safety factor $\gamma_2 = 1.0$ is included

3) Characteristic bending moment $M_{Rk,S}^0$ for equation (5.5) in ETAG 001, Annex C

The anchor is to be used only for multiple use for non-structural applications, the definition of multiple use according to the Member States is given in the informative Annex 1 of ETAG 001, Part 6.

WAKAI Ceiling Fastening Anchor

**Installation parameters
 Design method C:
 Characteristic values**

Annex 3

of European
 technical approval
ETA-04/0025