

Deutsches Institut für Bautechnik

Anstalt des öffentlichen Rechts

Kolonnenstr. 30 L
10829 Berlin
Germany

Tel.: +49(0)30 787 30 0
Fax: +49(0)30 787 30 320
E-mail: dibt@dibt.de
Internet: www.dibt.de

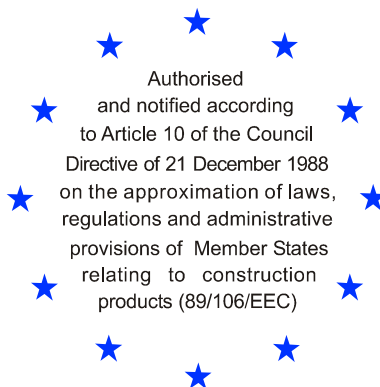

DIBt

Mitglied der EOTA
Member of EOTA

European Technical Approval ETA-04/0026

English translation prepared by DIBt - Original version in German language

Handelsbezeichnung
Trade name

Kunkel Dübel K6, K6+, K6L und K8
Kunkel anchor K6, K6+, K6L and K8

Zulassungsinhaber
Holder of approval

Kunkel GmbH
Befestigungssysteme
Jakobstraße 24
66115 Saarbrücken
DEUTSCHLAND

Zulassungsgegenstand
und Verwendungszweck
*Generic type and use
of construction product*

Wegkontrolliert spreizender Dübel für die Verwendung als
Mehrfachbefestigung von nichttragenden Systemen in Beton
*Deformation-controlled expansion anchor for multiple use for non-structural
applications in concrete*

Geltungsdauer: vom
Validity: from
bis
to

29 October 2010
23 April 2014

Herstellwerk
Manufacturing plant

Kunkel GmbH Befestigungssysteme

Diese Zulassung umfasst
This Approval contains

17 Seiten einschließlich 9 Anhänge
17 pages including 9 annexes

Diese Zulassung ersetzt
This Approval replaces

ETA-04/0026 mit Geltungsdauer vom 23.04.2009 bis 23.04.2014
ETA-04/0026 with validity from 23.04.2009 to 23.04.2014



Europäische Organisation für Technische Zulassungen
European Organisation for Technical Approvals

I LEGAL BASES AND GENERAL CONDITIONS

- 1 This European technical approval is issued by Deutsches Institut für Bautechnik in accordance with:
 - Council Directive 89/106/EEC of 21 December 1988 on the approximation of laws, regulations and administrative provisions of Member States relating to construction products¹, modified by Council Directive 93/68/EEC² and Regulation (EC) N° 1882/2003 of the European Parliament and of the Council³;
 - Gesetz über das In-Verkehr-Bringen von und den freien Warenverkehr mit Bauprodukten zur Umsetzung der Richtlinie 89/106/EWG des Rates vom 21. Dezember 1988 zur Angleichung der Rechts- und Verwaltungsvorschriften der Mitgliedstaaten über Bauprodukte und anderer Rechtsakte der Europäischen Gemeinschaften (Bauproduktengesetz - BauPG) vom 28. April 1998⁴, as amended by law of 31 October 2006⁵;
 - Common Procedural Rules for Requesting, Preparing and the Granting of European technical approvals set out in the Annex to Commission Decision 94/23/EC⁶;
 - Guideline for European technical approval of "Metal anchors for use in concrete - Part 6: Anchors for multiple use for non-structural applications", ETAG 001-06.
- 2 Deutsches Institut für Bautechnik is authorized to check whether the provisions of this European technical approval are met. Checking may take place in the manufacturing plant. Nevertheless, the responsibility for the conformity of the products to the European technical approval and for their fitness for the intended use remains with the holder of the European technical approval.
- 3 This European technical approval is not to be transferred to manufacturers or agents of manufacturers other than those indicated on page 1, or manufacturing plants other than those indicated on page 1 of this European technical approval.
- 4 This European technical approval may be withdrawn by Deutsches Institut für Bautechnik, in particular pursuant to information by the Commission according to Article 5(1) of Council Directive 89/106/EEC.
- 5 Reproduction of this European technical approval including transmission by electronic means shall be in full. However, partial reproduction can be made with the written consent of Deutsches Institut für Bautechnik. In this case partial reproduction has to be designated as such. Texts and drawings of advertising brochures shall not contradict or misuse the European technical approval.
- 6 The European technical approval is issued by the approval body in its official language. This version corresponds fully to the version circulated within EOTA. Translations into other languages have to be designated as such.

1 Official Journal of the European Communities L 40, 11 February 1989, p. 12

2 Official Journal of the European Communities L 220, 30 August 1993, p. 1

3 Official Journal of the European Union L 284, 31 October 2003, p. 25

4 *Bundesgesetzblatt Teil I 1998*, p. 812

5 *Bundesgesetzblatt Teil I 2006*, p.2407, 2416

6 Official Journal of the European Communities L 17, 20 January 1994, p. 34

II SPECIFIC CONDITIONS OF THE EUROPEAN TECHNICAL APPROVAL

1 Definition of the product and intended use

1.1 Definition of the construction product

The Kunkel anchor K6, K6+, K6L and K8 is an anchor made of galvanised steel, stainless or high corrosion resistant steel which is placed into a drilled hole and anchored by deformation-controlled expansion.

An illustration of the product and intended use is given in Annex 1.

1.2 Intended use

The anchor is intended to be used for anchorages for which requirements for safety in use in the sense of the Essential Requirements 4 of Council Directive 89/106 EEC shall be fulfilled and failure of the fixture represents an immediate risk to human life. The anchor is to be used only for multiple use for non-structural applications. The definition of multiple use according to the Member States is given in the informative Annex 1 of ETAG 001, Part 6.

The anchor may be used for anchorages with requirements related to resistance to fire.

The anchor is to be used only for anchorages subject to static or quasi-static loading in reinforced or unreinforced normal weight concrete of strength classes C20/25 at minimum and C50/60 at most according to EN 206-1:2000. It may be anchored in cracked or non-cracked concrete.

Kunkel anchor K6, K6+, K6L, K8 (galvanised steel):

The anchor may only be used in structures subject to dry internal conditions.

Kunkel anchor K6E, K6+E, K6LE, K8E (stainless steel 1.4401, 1.4404) and

Kunkel anchor K6X, K6+X, K6LX, K8X (stainless steel 1.4571):

The anchor made of stainless steel may be used in structures subject to dry internal conditions and also in structures subject to external atmospheric exposure (including industrial and marine environment), or exposure in permanently damp internal conditions, if no particular aggressive conditions exist. Such particular aggressive conditions are e.g. permanent, alternating immersion in seawater or the splash zone of seawater, chloride atmosphere of indoor swimming pools or atmosphere with extreme chemical pollution (e.g. in desulphurization plants or road tunnels where de-icing materials are used).

Kunkel anchor K6C, K6+C, K6LC, K8C (high corrosion resistant steel 1.4529, 1.4565):

The anchor made of high corrosion resistant steel may be used in structures subject to dry internal conditions and also in structures subject to external atmospheric exposure, in permanently damp internal conditions or in other particular aggressive conditions. Such particular aggressive conditions are e.g. permanent, alternating immersion in seawater or the splash zone of seawater, chloride atmosphere of indoor swimming pools or atmosphere with chemical pollution (e.g. in desulphurization plants or road tunnels where de-icing materials are used).

The provisions made in this European technical approval are based on an assumed working life of the anchor of 50 years. The indications given on the working life cannot be interpreted as a guarantee given by the producer, but are to be regarded only as a means for choosing the right products in relation to the expected economically reasonable working life of the works.

2 Characteristics of the product and methods of verification

2.1 Characteristics of the product

The anchor corresponds to the drawings and provisions given in Annexes 1 to 5. The characteristic material values, dimensions and tolerances of the anchor not given in Annexes 1 to 5 shall correspond to the respective values laid down in the technical documentation⁷ of this European technical approval.

Regarding the requirements concerning safety in case of fire it is assumed that the anchor meets the requirements of class A1 in relation to reaction to fire in accordance with the stipulations of the Commission decision 96/603/EC, amended by 2000/605/EC.

The characteristic values for the design of anchorages are given in Annex 6, Table 6 and Annex 7, Table 8. The characteristic values for the design of the anchorages regarding resistance to fire are given in Annex 8, Table 9. They are valid for use in a system that is required to provide a specific fire resistance class.

Each anchor is marked with the identifying mark of the producer including the anchor type and the thread size according to Annex 1.

The anchor shall only be packaged and supplied as a complete unit.

2.2 Methods of verification

The assessment of fitness of the anchor for the intended use in relation to the requirements for safety in use in the sense of the Essential Requirements 4 has been made in accordance with the "Guideline for European technical approval of Metal Anchors for use in concrete", Part 1 "Anchors in general" and Part 6 "Anchors for multiple use for non-structural applications".

The assessment of the anchor for the intended use in relation to the requirements for resistance to fire has been made in accordance with the Technical Report TR 020 "Evaluation of anchorages in concrete concerning resistance to fire".

In addition to the specific clauses relating to dangerous substances contained in this European technical approval, there may be other requirements applicable to the products falling within its scope (e.g. transposed European legislation and national laws, regulations and administrative provisions). In order to meet the provisions of the Construction Products Directive, these requirements need also to be complied with, when and where they apply.

3 Evaluation and attestation of conformity and CE marking

3.1 System of attestation of conformity

According to the decision 97/161/EG of the European Commission⁸ the system 2(ii) (referred to as system 2+) of attestation of conformity applies.

This system of attestation of conformity is defined as follows:

System 2+: Declaration of conformity of the product by the manufacturer on the basis of:

- (a) Tasks for the manufacturer:
 - (1) initial type-testing of the product;
 - (2) factory production control;
 - (3) testing of samples taken at the factory in accordance with a prescribed test plan.

⁷ The technical documentation of this European technical approval is deposited at the Deutsches Institut für Bautechnik and, as far as relevant for the tasks of the approved bodies involved in the attestation of conformity procedure, is handed over to the approved bodies.

⁸ Official Journal of the European Communities L 67 of 03.02.1997

(b) Tasks for the approved body:

(4) certification of factory production control on the basis of:

- initial inspection of factory and of factory production control;
- continuous surveillance, assessment and approval of factory production control.

Note: Approved bodies are also referred to as "notified bodies".

3.2 Responsibilities

3.2.1 Tasks for the manufacturer

3.2.1.1 Factory production control

The manufacturer shall exercise permanent internal control of production. All the elements, requirements and provisions adopted by the manufacturer shall be documented in a systematic manner in the form of written policies and procedures, including records of results performed. This production control system shall insure that the product is in conformity with this European technical approval.

The manufacturer may only use initial / raw / constituent materials stated in the technical documentation of this European technical approval.

The factory production control shall be in accordance with the control plan relating which is part of the technical documentation of this European technical approval. The control plan is laid down in the context of the factory production control system operated by the manufacturer and deposited with Deutsches Institut für Bautechnik.⁹

The results of factory production control shall be recorded and evaluated in accordance with the provisions of the control plan.

3.2.1.2 Other tasks of manufacturer

The manufacturer shall, on the basis of a contract, involve a body which is approved for the tasks referred to in section 3.1 in the field of anchors in order to undertake the actions laid down in section 3.2.2. For this purpose, the control plan referred to in sections 3.2.1.1 and 3.2.2 shall be handed over by the manufacturer to the approved body involved.

The manufacturer shall make a declaration of conformity, stating that the construction product is in conformity with the provisions of this European technical approval.

3.2.2 Tasks for the approved bodies

The approved body shall perform the

- initial inspection of factory and of factory production control,
- continuous surveillance, assessment and approval of factory production control.

in accordance with the provisions laid down in the control plan relating to this European technical approval.

The approved body shall retain the essential points of its actions referred to above and state the results obtained and conclusions drawn in a written report.

The approved certification body involved by the manufacturer shall issue an EC certificate of conformity of the factory production control stating the conformity with the provisions of this European technical approval.

In cases where the provisions of the European technical approval and its control plan are no longer fulfilled the certification body shall withdraw the certificate of conformity and inform Deutsches Institut für Bautechnik without delay.

⁹ The control plan is a confidential part of the European technical approval and only handed over to the approved body involved in the procedure of attestation of conformity. See section 3.2.2.

3.3 CE marking

The CE marking shall be affixed on each packaging of the anchor. The letters "CE" shall be followed by the identification number of the approved certification body, where relevant, and be accompanied by the following additional information:

- the name and address of the producer (legal entity responsible for the manufacture),
- the last two digits of the year in which the CE marking was affixed,
- the number of the EC certificate for the factory production control,
- the number of the European technical approval,
- the number of the guideline for European technical approval,
- use category (ETAG 001-6),
- size.

4 Assumptions under which the fitness of the product for the intended use was favourably assessed

4.1 Manufacturing

The European technical approval is issued for the product on the basis of agreed data/information, deposited with the Deutsches Institut für Bautechnik, which identifies the product that has been assessed and judged. Changes to the product or production process, which could result in this deposited data/information being incorrect, should be notified to the Deutsches Institut für Bautechnik before the changes are introduced. Deutsches Institut für Bautechnik will decide whether or not such changes affect the approval and consequently the validity of the CE marking on the basis of the approval and if so whether further assessment or alterations to the approval shall be necessary.

4.2 Design of anchorages

The fitness of the anchor for the intended use is given under the following conditions:

The anchorages are designed in accordance with the "Guideline for European technical approval of Metal Anchors for Use in Concrete", Annex C, Method C under the responsibility of an engineer experienced in anchorages and concrete work.

The anchor is to be used only for multiple use for non-structural applications, the definition of multiple use according to the Member States is given in the informative Annex 1 of ETAG 001, Part 6.

Verifiable calculation notes and drawings are prepared taking account of the loads to be anchored.

The position of the anchor is indicated on the design drawings (e.g. position of the anchor relative to reinforcement or to supports).

The design of the fixture is such that in case of excessive slip or failure of one anchor the load can be transmitted to neighbouring anchors.

The design of anchorages under fire exposure has to consider the conditions given in the Technical Report TR 020 "Evaluation of anchorages in concrete concerning resistance to fire". The relevant characteristic values are given in Annex 8, Table 9. The design method covers anchors with a fire attack from one side only. If the fire attack is from more than one side, the design method may be taken only, if the edge distance of the anchor is $c \geq 300$ mm.

4.3 Installation of anchors

The fitness for use of the anchor can only be assumed if the anchor is installed as follows:

- Anchor installation carried out by appropriately qualified personnel and under the supervision of the person responsible for technical matters of the site.
- Use of the anchor only as supplied by the manufacturer without exchanging the components of an anchor.
- Anchor installation in accordance with the manufacturer's specifications and drawings and using the appropriate tools.
- Checks before placing the anchor to ensure that the strength class of the concrete in which the anchor is to be placed is in the range given and is not lower than that of the concrete to which the characteristic loads apply.
- Check of concrete being well compacted, e.g. without significant voids.
- Edge distances and spacings not less than the specified values without minus tolerances.
- Positioning of the drill holes without damaging the reinforcement.
- In case of aborted hole: new drilling at a minimum distance away of twice the depth of the aborted hole or smaller distance if the aborted drill hole is filled with high strength mortar and if under shear or oblique tension load it is not in the direction of load application.
- Cleaning of the hole of drilling dust.
- Anchor installation such that the effective setting depth is complied with. This compliance is ensured, if the drill hole is made with the appropriate depth guided stop drills.
- Anchor expansion by impact using the setting tools given in Annexes 2 to 4. The anchor with external thread for pre-set installation or anchor internal thread is properly expanded if the setting tool rests on the concrete surface (see Annex 2 and 4). The anchor for through-set installation is properly expanded if the setting tool rests on the surface of the fixture (see Annex 3).
- The screw-in depth of fastening screw or threaded rod for anchors with internal thread must be at least the nominal thread size.
- Installation torque moments are not required for functioning of the anchor. However, the torque moments given in Annex 6 and 7 must not be exceeded.

5 Responsibility of the manufacturer

The manufacturer is responsible to ensure that the information on the specific conditions according to 1 and 2 including Annexes referred to as well as sections 4.2 and 4.3 is given to those who are concerned. This information may be made by reproduction of the respective parts of the European technical approval. In addition all installation data shall be shown clearly on the package and/or on an enclosed instruction sheet, preferably using illustration(s).

The minimum data required are:

- required appropriate stop drill,
- required appropriate setting tool,
- minimum and maximum thickness of fixture for the anchor type,
- size of connecting thread,

- information on the installation procedure, including cleaning of the hole, preferably by means of an illustration,
- maximum torque moment,
- identification of the manufacturing batch.

All data shall be presented in a clear and explicit form.

Georg Feistel
Head of Department

beglaubigt
Lange

Multiple use for non-structural applications only in accordance with ETAG 001 Part 6 Annex 1

Material	Anchor size / Marking			
	K6	K6+	K6L	K8
Steel galvanized according to EN ISO 4042	K6	K6+	K6L	K8
Stainless steel 1.4401 according to EN 10088	K6E	K6+E	K6LE	K8E
Stainless steel 1.4404 according to EN 10088	K6E	K6+E	K6LE	K8E
Stainless steel 1.4571 according to EN 10088	K6X	K6+X	K6LX	K8X
High corrosion resistant steel 1.4529 acc. to EN 10088	K6C	K6+C	K6LC	K8C
High corrosion resistant steel 1.4565 acc. to EN 10088	K6C	K6+C	K6LC	K8C
Depth of drill hole h_1	32 mm	37 mm	42 mm	43 mm
Effective anchorage depth h_{ef}	26 mm	31 mm	36 mm	36 mm

Concrete
C20/25 to C50/60

Marking:
e.g. K6L

Different head forms and thread sizes are admissible

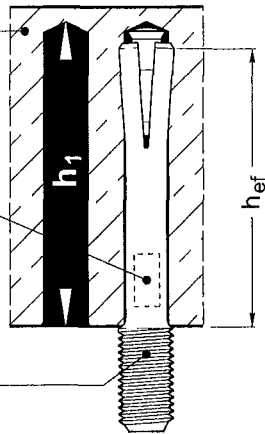

Length indicator*

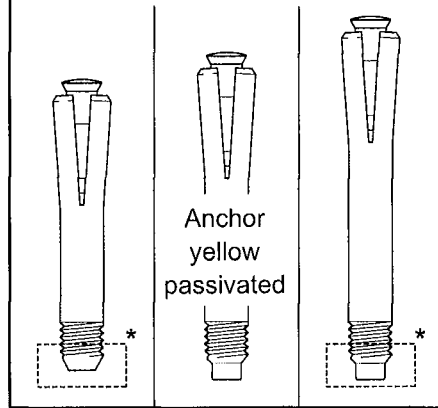

The anchor may only be set with appropriate stop drills and setting tools.

Different installations with different head forms of the anchor

Pre-positioned installation

In-place installation

Counter-sunk installation

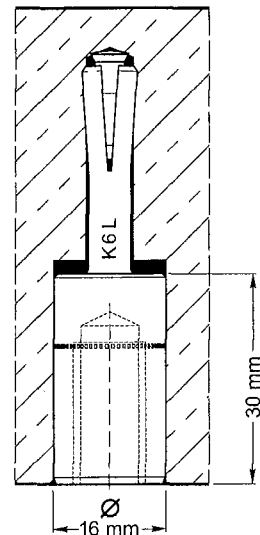
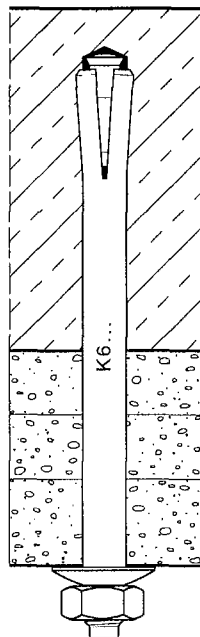
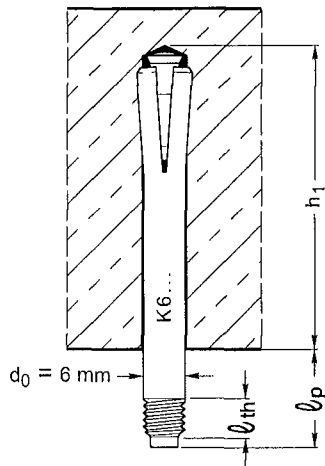

l_{th} = Length of connection thread
 l_p = Length of protrusion

KUNKEL Anchor K6 / K6+ / K6L / K8 (... E, ... X, ... C)

Product and intended use

Annex 1
of European technical approval
ETA-04/0026

Table 1 Pre-positioned installation - Head forms, appropriate stop drills **K6, K6+, K6L (...E, ...X, ...C)** and setting tools, installation parameters and material of anchor

Anchor type	K6 x ℓ_p	K6-8 x ℓ_p	KMu 6	KMu 8
Thread size	External thread M6	External thread M8	Internal thread M6	Internal thread M8
Setting tool	EWA 6 x ℓ_p	EWA 8 x ℓ_p	SMu 6	SMu 8
Length of thread ℓ_{th} [mm]	$5 \leq \ell_{th} \leq 50$		-	-
Length of protrusion ℓ_p [mm]	$5 \leq \ell_p \leq 300$		-	-
Screw-in depth [mm]			6 to 12	8 to 12

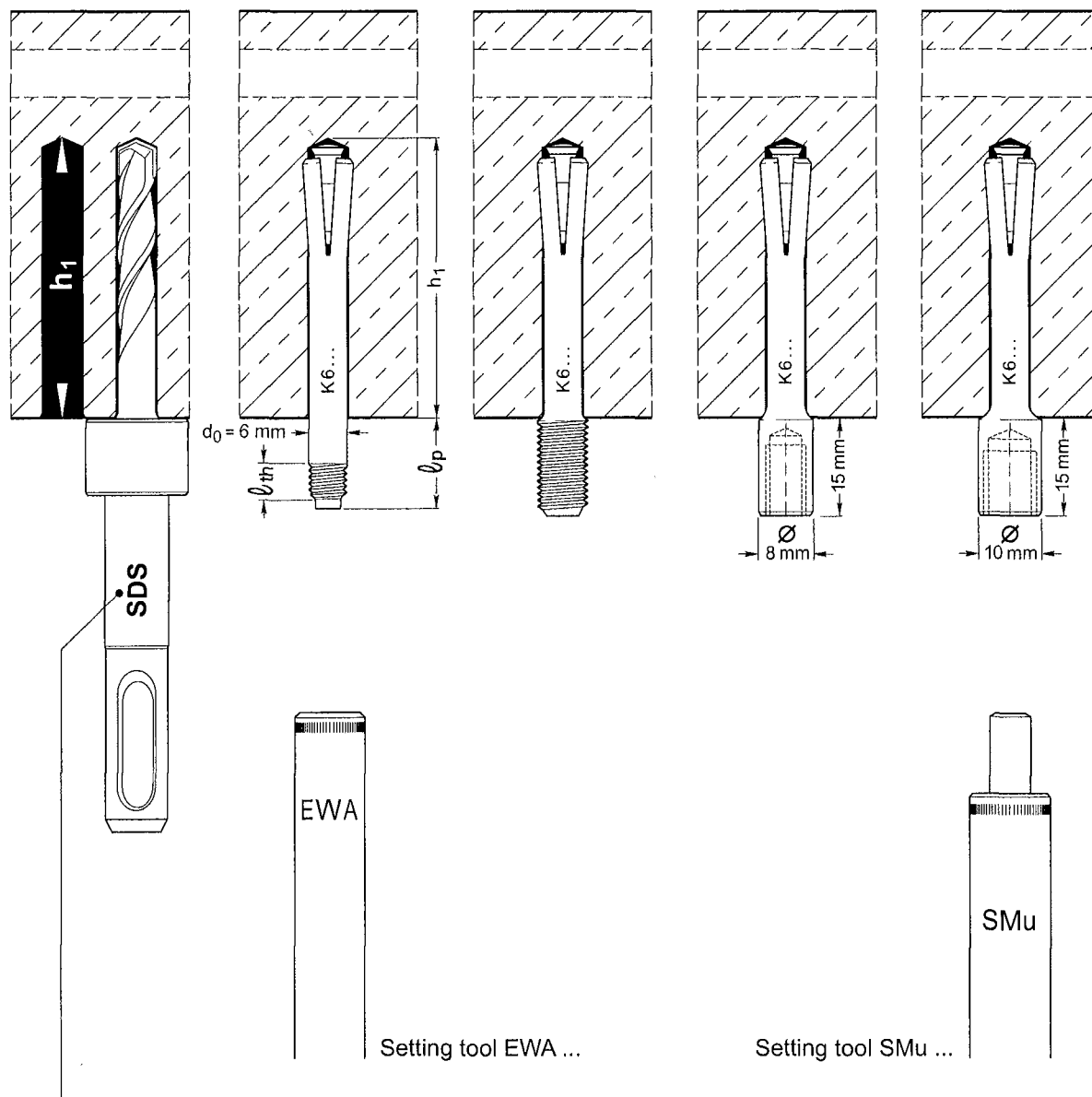

Anchor size	K6	K6+	K6L
Appropriate stop drill	SDS 1	SDS +	SDS 2

KUNKEL Anchor K6 / K6+ / K6L / K8 (...E, ...X, ...C)

Anchor size K6, K6+, K6L

Pre-positioned installation - Head forms, appropriate stop drills and setting tools, Installation parameters, material

Annex 2

of European technical approval
ETA-04/0026

Table 2
K8 (...E, ...X, ...C)

Pre-positioned installation - Head forms, appropriate stop drills and setting tools, installation parameters and material of anchor

Anchor type	K8 x l_p	K8-10 x l_p	K8-M8i	K8-M10i	K8-M12i	K8-M8i/M10i
Thread size	External thread M8	External thread M10	Internal thread M8	Internal thread M10	Internal thread M12	Internal thread M8/M10
Setting tool	EWA8 x l_p	EWA10 x l_p	Si 8 - SM	Si 10 - SM	Si 12 - SM	Si 8 - SM
Length of thread l_{th} [mm]	$5 \leq l_{th} \leq 50$	$5 \leq l_{th} \leq 50$	-			
Length of protrusion l_p [mm]	$5 \leq l_p \leq 300$	$5 \leq l_p \leq 300$	-			
Screw-in depth [mm]	-		8 to 10	10 to 15	12 to 15	M 8: 8 to 10 M 10: 10
Stop drill	SDS 8 x 43					

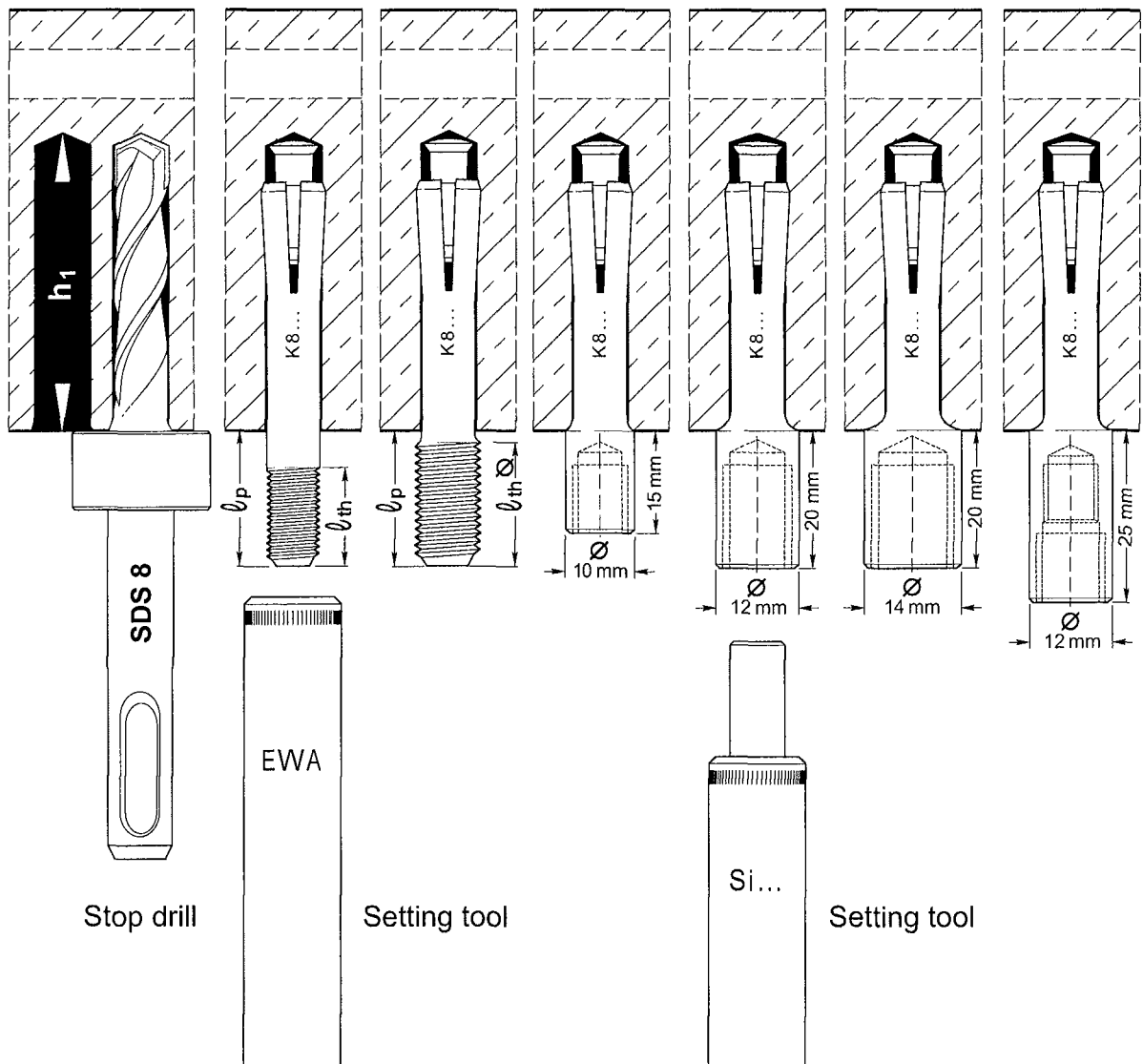

KUNKEL Anchor K6 / K6+ / K6L / K8 (...E, ...X, ...C)

Anchor size K8

Pre-positioned installation - Head forms, appropriate stop drills and setting tools, material

Annex 3

of European technical approval
ETA-04/0026

Table 3 In-Place installation - Anchor types, appropriate stop drills and setting tools, installation parameters and material of anchor
K6, K6+, K6L, K8 (...E,...X,...C)

Anchor type	KDM 6 x t _{fix} / ...N KDM 8 x t _{fix} / ...N with washer and hexagon nut	K6 x t _{fix} / ...N K8 x t _{fix} / ...N
Thread size	M6 / M8	M6 / M8
Setting tool	SWM ...	EWA ...
Length of thread ℓ_{th} [mm]	≥ 5	≥ 5
Length of protrusion t _{fix} [mm]	≤ 300	
Stop drill	SDS ...	

the type of stop drill depends on the required thickness of fixture t_{fix}

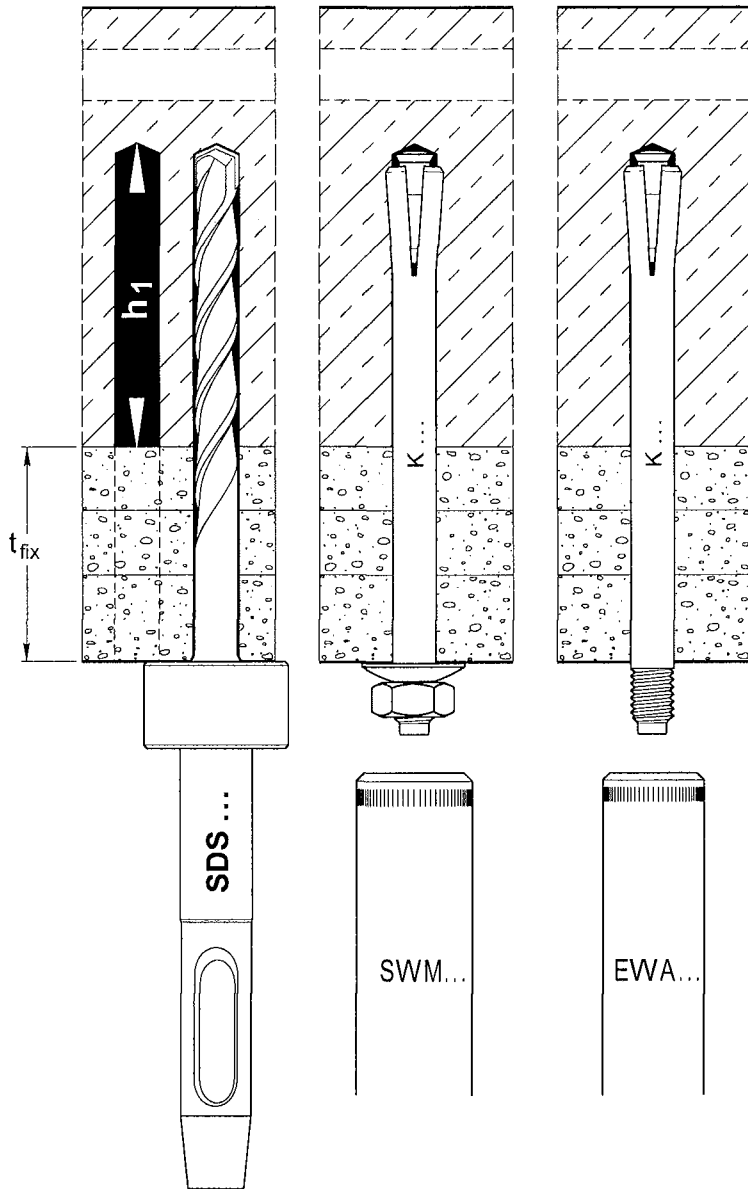

KUNKEL Anchor K6 / K6+ / K6L / K8 (...E,...X,...C)

Anchor size K6, K6+, K6L, K8
 In-Place installation - Head forms, appropriate stop drills and setting tools, material

Annex 4
 of European technical approval
ETA-04/0026

Table 4 K6L Counter-sunk installation - Head forms, appropriate stop drills and setting tools, installation parameters and material of anchor

Anchor type	KMu F 10	KMu F 12
Thread size	M 10	M 12
Setting tool	SMu 10 H	SMu 12 H
Screw-in depth [mm]	10 to 18	12 to 18
Stop drill	SDS DUO HV...	
Material	galvanised steel $\geq 5 \mu\text{m}$ according to EN ISO 4042	

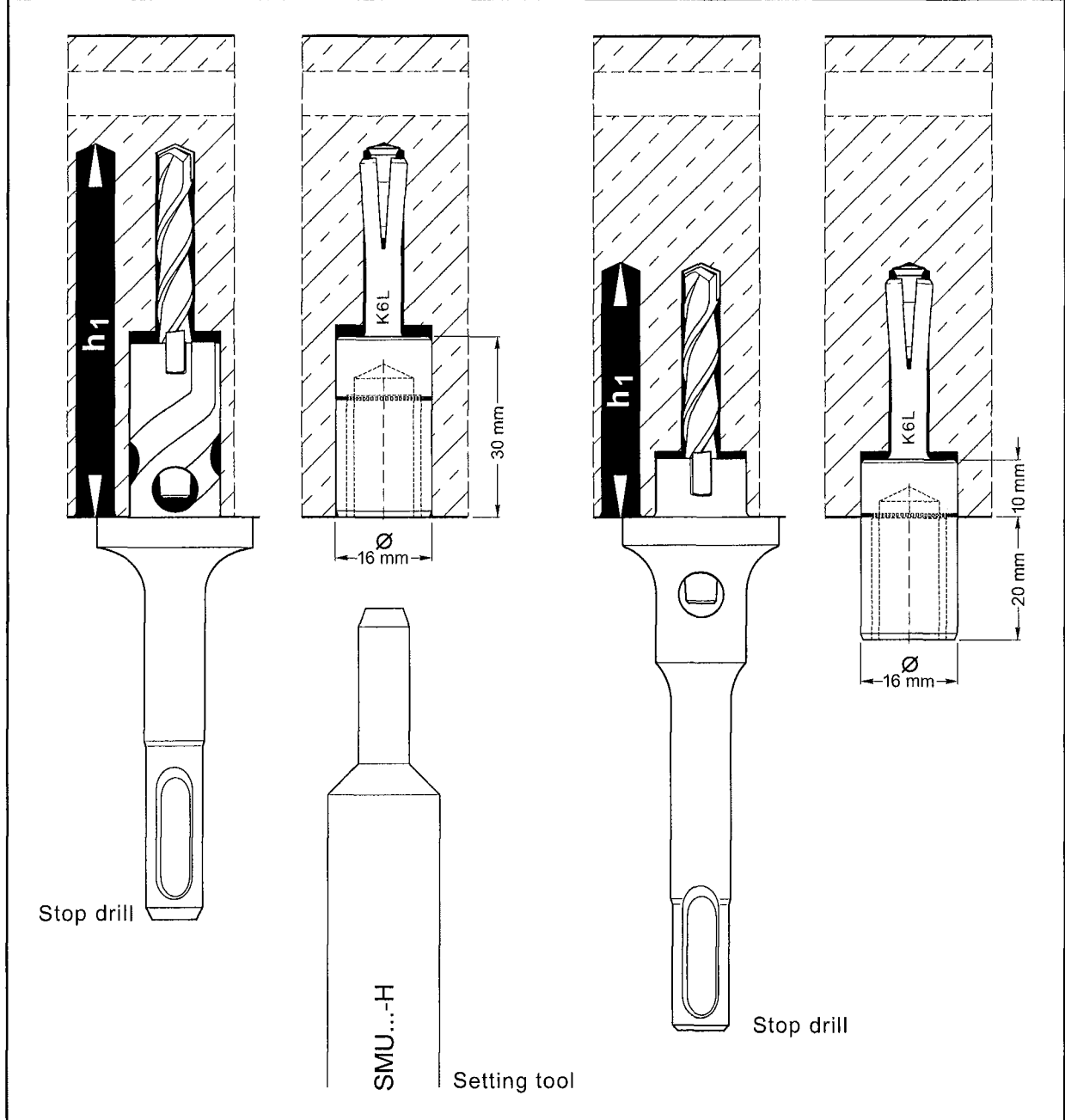

KUNKEL Anchor K6 / K6+ / K6L / K8

Anchor size K6L
 Counter-sunk installation - Head forms, appropriate stop drills and setting tools, material

Annex 5
 of European technical approval
ETA-04/0026

Table 5 Installation parameters

Anchor type		K6	K6+	K6L	K8
Diameter of drill hole	d_0 [mm]	6	6	6	8
Depth of drill hole	$h_1 \geq$ [mm]	32	37	42	43
Minimum thickness of member	h_{min} [mm]	80	80	80	100
Effective anchorage depth	$h_{ef} \geq$ [mm]	26	31	36	36
Maximum torque moment	T_{inst} [Nm]	5	5	5	10
Spacing	$s_{cr} \geq$ [mm]	200			
Edge distance	$c_{cr} \geq$ [mm]	150			

Table 6 Characteristic values of resistance (Design method C)

Anchor type		K6	K6+	K6L	K8
Any load direction					
Characteristic resistance in C20/25 to C50/60	$F_{Rk}^{2)}$ [kN]	2	2.5	5	5
Partial safety factor (including installation safety factor γ_2)	$\gamma_M^{1)}$ [-]	1.8	1.8	2.52	2.52
Shear load with lever arm					
Characteristic bending moment	$M_{Rk,s}^{3)}$ [Nm]	3.6	7.7	18	
Partial safety factor	$\gamma_{Ms}^{1)}$ [-]	1.25			

- 1) In absence of other national regulations
- 2) The anchor is to be used only for multiple use for non-structural applications, the definition of multiple use according to the Member States is given in the informative Annex 1 of ETAG 001, Part 6
- 3) Characteristic bending moment $M_{Rk,s}^0$ for equation (5.5) in ETAG 001, Annex C

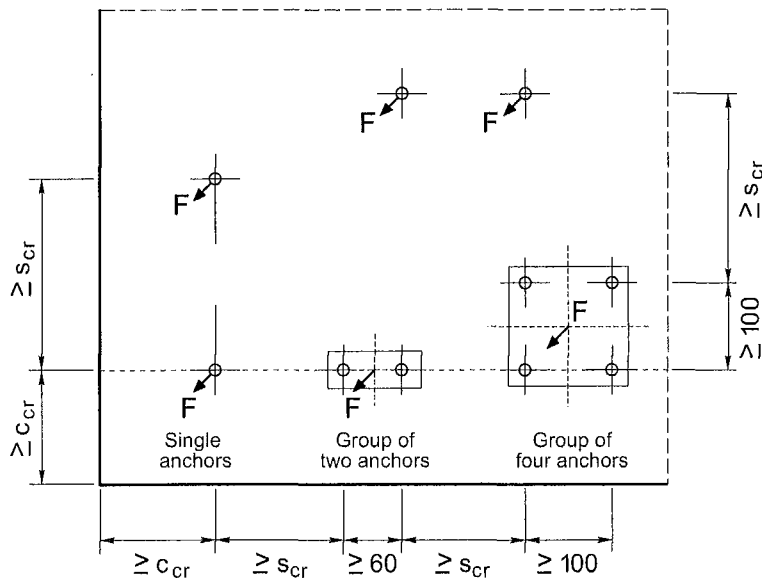

The values given in Table 6 are valid for one fixing point.

Fixing points can be:

- **single anchors,**
- **groups of two anchors** with $s_1 \geq 60$ mm or
- **groups of four anchors** with $s_1 = s_2 \geq 100$ mm

KUNKEL Anchor K6 / K6+ / K6L / K8

Installation parameters - Characteristic values of resistance for single anchors and anchor groups, for anchors made of galvanized steel

Annex 6

of European technical approval
ETA-04/0026

Table 7 Installation parameters

Anchor size		K6 E,X,C	K6+E,X,C	K6LE,X,C	K8 E,X,C
Diameter of drill hole	d_0 [mm]	6	6	6	8
Depth of drill hole	$h_1 \geq$ [mm]	32	37	42	43
Effective anchorage depth	$h_{ef} \geq$ [mm]	26	31	36	36
Maximum torque moment	T_{inst} [Nm]	5	5	5	10
Minimum thickness of member	h_{min} [mm]	80			
Spacing	$s_{cr} \geq$ [mm]	200			
Edge distance	$c_{cr} \geq$ [mm]	150			

Table 8 Characteristic values of resistance (Design method C)

Anchor size		K6 E,X,C	K6+E,X,C	K6LE,X,C	K8 E,X,C
Any load direction					
Characteristic resistance in C20/25 to C50/60	$F_{RK}^{(2)}$ [kN]	1.5	2.5	3	5
Partial safety factor (including installation safety factor γ_2)	$\gamma_{M1}^{(1)}$ [-]	2.52	2.16	2.52	2.16
Shear load with lever arm					
Characteristic bending moment	$M^0_{RK,s}^{(3)}$ [Nm]	4.0	8.4		20.6
Partial safety factor	$\gamma_{Ms}^{(1)}$ [-]	1.5			

1) In absence of other national regulations

2) The anchor is to be used only for multiple use for non-structural applications, the definition of multiple use according to the Member States is given in the informative Annex 1 of ETAG 001, Part 6

3) Characteristic bending moment $M^0_{RK,s}$ for equation (5.5) in ETAG 001, Annex C

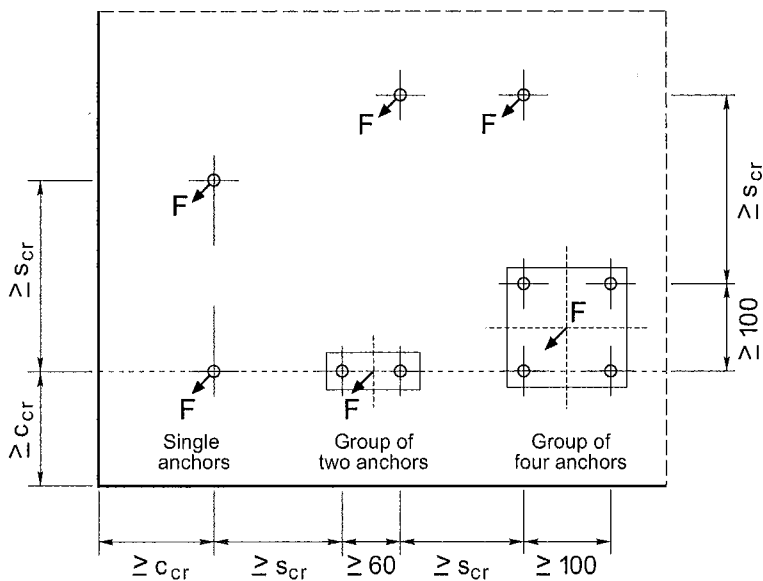

The values given in Table 8 are valid for one fixing point.

Fixing points can be:

- **single anchors,**
- **groups of two anchors** with $s_1 \geq 60$ mm or
- **groups of four anchors** with $s_1 = s_2 \geq 100$ mm

KUNKEL Anchor K6 / K6+ / K6L / K8 (... E, ... X, ... C)

Installation parameters - Characteristic values for single anchors and anchor groups, for anchors made of stainless steel and high corrosion resistant steel

Annex 7

of European technical approval
ETA-04/0026

Table 9 Characteristic values under fire exposure in all load directions in C20/25 to C50/60 (Design method C)						
Fire resistance class	Anchor size			K6 (..E,..X,..C)	K6+, K6L (..E,..X,..C)	K8 (..E,..X,..C)
R30	Characteristic resistance	$F_{Rk,fi(30)}$	[kN]	0.3	0.6	1.2
R60	Characteristic resistance	$F_{Rk,fi(60)}$	[kN]	0.3	0.5	1.0
R90	Characteristic resistance	$F_{Rk,fi(90)}$	[kN]	0.3	0.3	0.6
R120	Characteristic resistance	$F_{Rk,fi(120)}$	[kN]	0.2	0.2	0.4
R30 to R120	Spacing	$s_{cr} = s_{min}$	[mm]	200	200	200
	Edge distance for fire attack from one side only	$c_{cr} = c_{min}$	[mm]	150	150	150
	Edge distance for fire attack from more than one side	$c_{cr} = c_{min}$	[mm]	300	300	300
<p>In absence of other national regulations the partial safety factor for resistance under fire exposure $\gamma_{M,fi} = 1.0$ is recommended.</p>						
KUNKEL Anchor K6 / K6+ / K6L / K8 (... E, ... X, ... C)				Annex 8		
Design method C, Characteristic values under fire exposure in C20/25 to C50/60				of European technical approval ETA-04/0026		

Installation Instructions

External thread anchor K6, K6L and K8

Hand setting tool

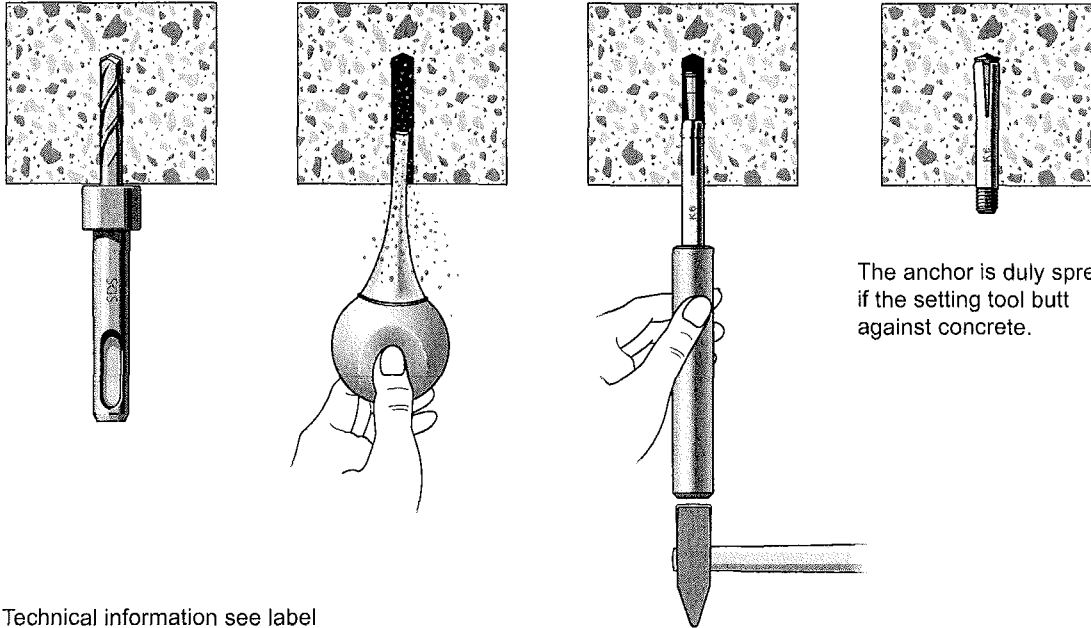

Technical information see label

Fire protection anchor KDM 6x.../N

Hand setting tool for all KDM 6x.../N

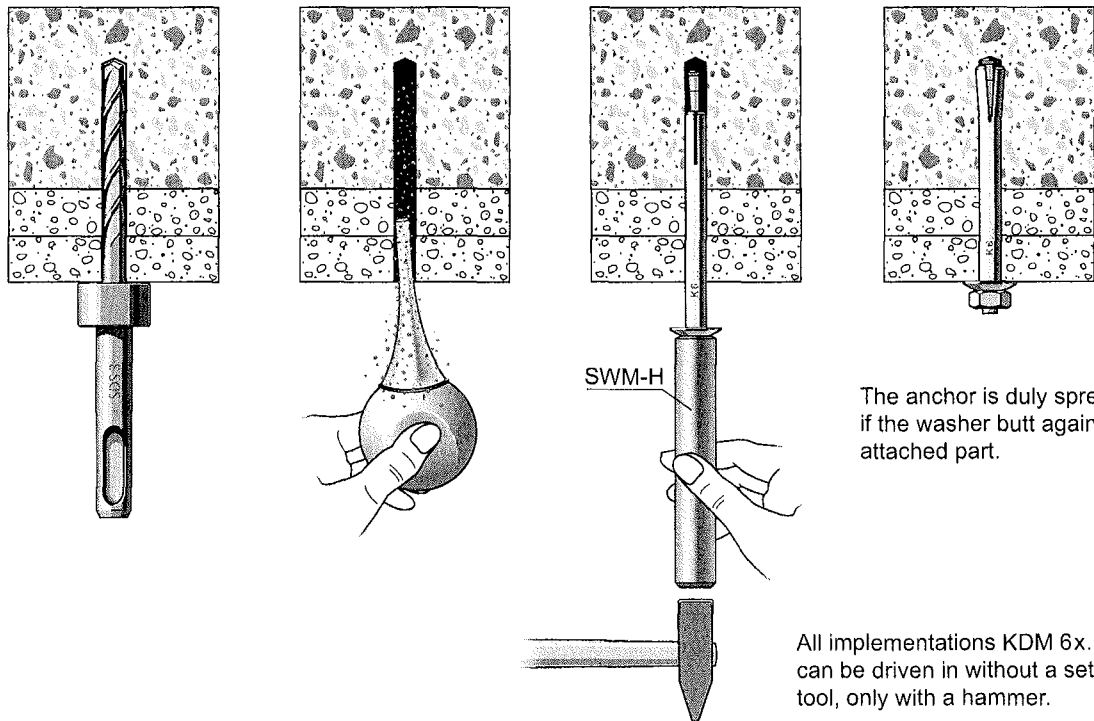

KUNKEL Anchor K6 / K6+ / K6L / K8 (... E, ... X, ... C)

Installation instructions for External tread anchor and Fire protection anchor

Annex 9

**of European technical approval
ETA-04/0026**