

Deutsches Institut für Bautechnik

Anstalt des öffentlichen Rechts

Kolonnenstr. 30 L
10829 Berlin
Germany

Tel.: +49(0)30 787 30 0
Fax: +49(0)30 787 30 320
E-mail: dibt@dibt.de
Internet: www.dibt.de

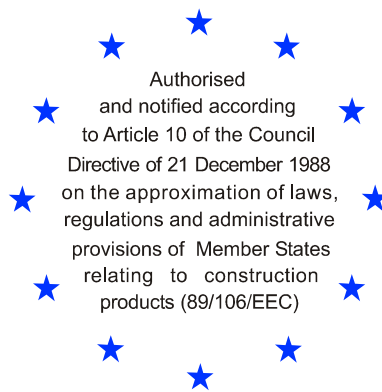

DIBt

Mitglied der EOTA
Member of EOTA

European Technical Approval ETA-05/0023

English translation prepared by DIBt - Original version in German language

Handelsbezeichnung
Trade name

Chemofast Injektionssystem STV / ALV
Chemofast Injection System STV / ALV

Zulassungsinhaber
Holder of approval

CHEMOFAST Anchoring GmbH
Hanns-Martin-Schleyer-Straße 23
47877 Willich
DEUTSCHLAND

Zulassungsgegenstand
und Verwendungszweck

*Generic type and use
of construction product*

Verbunddübel mit Ankerstange in den Größen M10, M12 und
M16 zur Verankerung im ungerissenen Beton

*Bonded anchor with anchor rod of sizes M10, M12 and M16 for use in
non-cracked concrete*

Geltungsdauer: vom
Validity: *from*
bis
to
verlängert vom
extended from
bis
to

17 October 2008
25 February 2010
8 March 2010
25 February 2015

Herstellwerk
Manufacturing plant

CHEMOFAST Anchoring GmbH
Hanns-Martin-Schleyer-Straße 23
47877 Willich
DEUTSCHLAND

Diese Zulassung umfasst
This Approval contains

16 Seiten einschließlich 7 Anhänge
16 pages including 7 annexes



Europäische Organisation für Technische Zulassungen
European Organisation for Technical Approvals

I LEGAL BASES AND GENERAL CONDITIONS

- 1 This European technical approval is issued by Deutsches Institut für Bautechnik in accordance with:
 - Council Directive 89/106/EEC of 21 December 1988 on the approximation of laws, regulations and administrative provisions of Member States relating to construction products¹, modified by Council Directive 93/68/EEC² and Regulation (EC) N° 1882/2003 of the European Parliament and of the Council³;
 - Gesetz über das In-Verkehr-Bringen von und den freien Warenverkehr mit Bauprodukten zur Umsetzung der Richtlinie 89/106/EWG des Rates vom 21. Dezember 1988 zur Angleichung der Rechts- und Verwaltungsvorschriften der Mitgliedstaaten über Bauprodukte und anderer Rechtsakte der Europäischen Gemeinschaften (Bauproduktengesetz - BauPG) vom 28. April 1998⁴, as amended by law of 31 October 2006⁵;
 - Common Procedural Rules for Requesting, Preparing and the Granting of European technical approvals set out in the Annex to Commission Decision 94/23/EC⁶;
 - Guideline for European technical approval of "Metal anchors for use in concrete - Part 5: Bonded anchors", ETAG 001-05.
- 2 Deutsches Institut für Bautechnik is authorized to check whether the provisions of this European technical approval are met. Checking may take place in the manufacturing plant. Nevertheless, the responsibility for the conformity of the products to the European technical approval and for their fitness for the intended use remains with the holder of the European technical approval.
- 3 This European technical approval is not to be transferred to manufacturers or agents of manufacturers other than those indicated on page 1, or manufacturing plants other than those indicated on page 1 of this European technical approval.
- 4 This European technical approval may be withdrawn by Deutsches Institut für Bautechnik, in particular pursuant to information by the Commission according to Article 5(1) of Council Directive 89/106/EEC.
- 5 Reproduction of this European technical approval including transmission by electronic means shall be in full. However, partial reproduction can be made with the written consent of Deutsches Institut für Bautechnik. In this case partial reproduction has to be designated as such. Texts and drawings of advertising brochures shall not contradict or misuse the European technical approval.
- 6 The European technical approval is issued by the approval body in its official language. This version corresponds fully to the version circulated in EOTA. Translations into other languages have to be designated as such.

1 Official Journal of the European Communities N° L 40, 11 February 1989, p. 12

2 Official Journal of the European Communities N° L 220, 30 August 1993, p. 1

3 Official Journal of the European Union N° L 284, 31 October 2003, p. 25

4 *Bundesgesetzblatt Teil I* 1998, p. 812

5 *Bundesgesetzblatt Teil I* 2006, p.2407, 2416

6 Official Journal of the European Communities N° L 17, 20 January 1994, p. 34

II SPECIFIC CONDITIONS OF THE EUROPEAN TECHNICAL APPROVAL

1 Definition of product and intended use

1.1 Definition of the construction product

The Chemofast Injection System STV / ALV with anchor rod SVZ is a bonded anchor consisting of a mortar cartridge with Chemofast Injection Mortar STV / ALV or STV / ALV Express and an anchor rod with hexagon nut and washer of sizes M10, M12 and M16. The anchor rod (including nut and washer) is made of galvanised steel, hot-dip galvanised steel, stainless steel 1.4401, 1.4404 or 1.4571 or made of high corrosion resistant steel 1.4529 or 1.4565.

The anchor rod is anchored via the bond between anchor rod, chemical mortar and concrete.

An illustration of the product and intended use is given in Annex 1.

1.2 Intended use

The anchor is intended to be used for anchorages for which requirements for mechanical resistance and stability and safety in use in the sense of the Essential Requirements 1 and 4 of Council Directive 89/106 EEC shall be fulfilled and failure of anchorages made with these products would cause risk to human life and/or lead to considerable economic consequences. Safety in case of fire (Essential Requirement 2) is not covered in this European technical approval. The anchor is to be used only for anchorages subject to static or quasi-static loading in reinforced or unreinforced normal weight concrete of strength classes C20/25 at minimum and C50/60 at most according to EN 206:2000-12.

The anchor may be anchored in non-cracked concrete only.

It may be installed in dry or wet concrete. It must not be installed in flooded holes.

Overhead installation is not admissible.

The anchor may be used in the following temperature ranges:

Temperature range I: -40 °C to +80 °C (max long term temperature +50 °C and max short term temperature +80 °C)

Temperature range II: -40 °C to +120 °C (max long term temperature +72 °C and max short term temperature +120 °C)

Zinc plated or hot-dip galvanised steel:

The anchor rod, nut and washer made of zinc plated or hot-dip galvanised steel may only be used in structures subject to dry internal conditions.

Stainless steel 1.4401, 1.4404, 1.4571:

The anchor rod, nut and washer made of stainless steel may be used in structures subject to dry internal conditions and also in structures subject to external atmospheric exposure (including industrial and marine environment), or exposure in permanently damp internal conditions, if no particular aggressive conditions exist. Such particular aggressive conditions are e.g. permanent, alternating immersion in seawater or the splash zone of seawater, chloride atmosphere of indoor swimming pools or atmosphere with extreme chemical pollution (e.g. in desulphurization plants or road tunnels where de-icing materials are used).

High corrosion resistant steel 1.4529, 1.4565:

The anchor rod, nut and washer made of high corrosion resistant steel 1.4529 or 1.4565 may be used in structures subject to dry internal conditions and also in structures subject to external atmospheric exposure, in permanently damp internal conditions or in other particular aggressive conditions. Such particular aggressive conditions are e.g. permanent, alternating immersion in seawater or the splash zone of seawater, chloride atmosphere of indoor swimming pools or atmosphere with chemical pollution (e.g. in desulphurization plants or road tunnels where de-icing materials are used).

The provisions made in this European technical approval are based on an assumed working life of the anchor of 50 years. The indications given on the working life cannot be interpreted as a guarantee given by the producer, but are to be regarded only as a means for choosing the right products in relation to the expected economically reasonable working life of the works.

2 Characteristics of product and methods of verification

2.1 Characteristics of product

The anchor corresponds to the drawings and provisions given in Annexes 1 to 4. The characteristic material values, dimensions and tolerances of the anchor not indicated in Annexes 1 to 4 shall correspond to the respective values laid down in the technical documentation⁷ of this European technical approval.

The characteristic values for the design of anchorages are given in Annexes 6 and 7.

Each mortar cartridge shall be marked with the imprint Chemofast Injection Mortar STV / ALV or STV / ALV Express, the size of the cartridge, processing notes, charge code, storage-life, hazard code and curing- and processing time in accordance with Annex 4.

The two components of the Chemofast Injection Mortar STV / ALV or STV / ALV Express are delivered in unmixed condition in mortar cartridges of 150 ml, 280 ml, 300 ml, 330 ml, 380 ml or 410 ml (coaxial type) or 345 ml (side-by-side type) according to Annex 4.

2.2 Methods of verification

The assessment of fitness of the anchor for the intended use in relation to the requirements for mechanical resistance and stability and safety in use in the sense of the Essential Requirements 1 and 4 has been made in accordance with the "Guideline for European technical approval of Metal Anchors for Use in Concrete", Part 1 "Anchors in general" and Part 5 "Bonded anchors", on the basis of Option 7.

In addition to the specific clauses relating to dangerous substances contained in this European technical approval, there may be other requirements applicable to the products falling within its scope (e.g. transposed European legislation and national laws, regulations and administrative provisions). In order to meet the provisions of the Construction Products Directive, these requirements need also to be complied with, when and where they apply.

⁷ The technical documentation of this European technical approval is deposited at the Deutsches Institut für Bautechnik and, as far as relevant for the tasks of the approved bodies involved in the attestation of conformity procedure, is handed over to the approved bodies.

3 Evaluation and attestation of conformity and CE marking

3.1 System of attestation of conformity

According to the decision 96/582/EG of the European Commission⁸ the system 2(i) (referred to as System 1) of attestation of conformity applies.

This system of attestation of conformity is defined as follows:

System 1: Certification of the conformity of the product by an approved certification body on the basis of:

(a) Tasks for the manufacturer:

- (1) factory production control;
- (2) further testing of samples taken at the factory by the manufacturer in accordance with a prescribed control plan;

(b) Tasks for the approved body:

- (3) initial type-testing of the product;
- (4) initial inspection of factory and of factory production control;
- (5) continuous surveillance, assessment and approval of factory production control.

Note: Approved bodies are also referred to as "notified bodies".

3.2 Responsibilities

3.2.1 Tasks of the manufacturer

3.2.1.1 Factory production control

The manufacturer shall exercise permanent internal control of production. All the elements, requirements and provisions adopted by the manufacturer shall be documented in a systematic manner in the form of written policies and procedures, including records of results performed. This production control system shall insure that the product is in conformity with this European technical approval.

The manufacturer may only use initial/raw/constituent materials stated in the technical documentation of this European technical approval.

The factory production control shall be in accordance with the control plan which is part of the technical documentation of this European technical approval. The control plan is laid down in the context of the factory production control system operated by the manufacturer and deposited at Deutsches Institut für Bautechnik.⁹

The results of factory production control shall be recorded and evaluated in accordance with the provisions of the control plan.

3.2.1.2 Other tasks of manufacturer

The manufacturer shall, on the basis of a contract, involve a body which is approved for the tasks referred to in section 3.1 in the field of anchors in order to undertake the actions laid down in section 3.2.2. For this purpose, the control plan referred to in sections 3.2.1.1 and 3.2.2 shall be handed over by the manufacturer to the approved body involved.

The manufacturer shall make a declaration of conformity, stating that the construction product is in conformity with the provisions of this European technical approval.

⁸ Official Journal of the European Communities L 254 of 08.10.1996

⁹ The control plan is a confidential part of the European technical approval and only handed over to the approved body involved in the procedure of attestation of conformity. See section 3.2.2.

3.2.2 Tasks of approved bodies

The approved body shall perform the following tasks in accordance with the provisions laid down in the control plan:

- initial type-testing of the product,
- initial inspection of factory and of factory production control,
- continuous surveillance, assessment and approval of factory production control.

The approved body shall retain the essential points of its actions referred to above and state the results obtained and conclusions drawn in a written report.

The approved certification body involved by the manufacturer shall issue an EC certificate of conformity of the product stating the conformity with the provisions of this European technical approval.

In cases where the provisions of the European technical approval and its control plan are no longer fulfilled the certification body shall withdraw the certificate of conformity and inform Deutsches Institut für Bautechnik without delay.

3.3 CE marking

The CE marking shall be affixed on each packaging of anchors. The letters "CE" shall be followed by the identification number of the approved certification body, where relevant, and be accompanied by the following additional information:

- the name and address of the holder of the approval (legal entity responsible for the manufacturer),
- the last two digits of the year in which the CE marking was affixed,
- the number of the EC certificate of conformity for the product,
- the number of the European technical approval,
- the number of the guideline for European technical approval,
- use category (ETAG 001-1, Option 7),
- size.

4 Assumptions under which the fitness of the product for the intended use was favourably assessed

4.1 Manufacturing

The anchor is manufactured in accordance with the provisions of the European technical approval using the automated manufacturing process as identified in the inspection of the plant by the Deutsches Institut für Bautechnik and the approved body and laid down in the technical documentation.

The European technical approval is issued for the product on the basis of agreed data/information, deposited with Deutsches Institut für Bautechnik, which identifies the product that has been assessed and judged. Changes to the product or production process, which could result in this deposited data/information being incorrect, should be notified to Deutsches Institut für Bautechnik before the changes are introduced. Deutsches Institut für Bautechnik will decide whether or not such changes affect the approval and consequently the validity of the CE marking on the basis of the approval and if so whether further assessment or alterations to the approval shall be necessary.

4.2 Design of anchorages

The fitness of the anchor for the intended use is given under the following conditions:

The anchorages are designed in accordance with the "Guideline for European technical approval of Metal Anchors for Use in Concrete", Annex C, Method A, for bonded anchors under the responsibility of an engineer experienced in anchorages and concrete work.

For the verifications given below according to Annex C the following shall be observed:

- For the verification 'concrete cone failure' (clause 5.2.2.4, Annex C of the Guideline) $N_{Rk,c}$ shall be determined according to (1) and (2): The smaller of the values according to (1) and (2) is decisive.

(1) $N_{Rk,c}$ according to equation (5.2), Annex C of the Guideline

where: $N_{Rk,c}^0$ according to Annex 6

$S_{cr,N}$ according to Annex 6

$C_{cr,N}$ according to Annex 6

$\Psi_{ucr,N} = 1,0$

In special cases according to clause 5.2.2.4 g, Annex C of the Guideline the method given there is valid. However, the value $N_{Rk,c}^0$ shall be calculated according to the following equation:

$$N_{Rk,c}^0 = N_{Rk,c}^0 \text{ (Annex 6)} \times \frac{h'_{ef}}{h_{ef}}$$

(2) $N_{Rk,c}$ according to equation (5.2), Annex C of the Guideline

where: $N_{Rk,c}^0 = 0,75 \times 15,5 \times h_{ef}^{1,5} \times f_{ck,cube}^{0,5}$

$S_{cr,N} = 3 h_{ef}$

$C_{cr,N} = 1,5 h_{ef}$

$\Psi_{ucr,N} = 1,0$

- For the verification 'splitting failure due to loading' (clause 5.2.2.6, Annex C of the Guideline) $N_{Rk,sp}$ shall be determined according to (3).

(3) $N_{Rk,sp}$ according to equation (5.3), Annex C of the Guideline

where: $N_{Rk,c}^0$ according to Annex 6

$S_{cr,sp}$ according to Annex 6

$C_{cr,sp}$ according to Annex 6

$\Psi_{ucr,N} = 1,0$

$\Psi_{h,sp} = 1,0$

- For the verification 'concrete pryout failure' (clause 5.2.3.3, Annex C of the Guideline) $N_{Rk,c}$ for equation (5.6), Annex C of the Guideline, shall be determined according to (1).

Verifiable calculation notes and drawings are prepared taking account of the loads to be anchored.

The position of the anchor is indicated on the design drawings (e.g. position of the anchor relative to reinforcement or to supports, etc.).

4.3 Installation of anchors

The fitness for use of the anchor can only be assumed if the anchor is installed as follows:

- anchor installation carried out by appropriately qualified personnel and under the supervision of the person responsible for technical matters of the site,
- use of the anchor only as supplied by the manufacturer without exchanging the components of an anchor, commercial standard threaded rods, washers and hexagon nuts may also be used if the following requirements are fulfilled:
 - Material and mechanical properties according to Annex 2,
 - Confirmation of material and mechanical properties by inspection certificate according to EN 10204:2004,
 - Identifying mark of the producer and marking of embedment depth according to Annex 2.
- anchor installation in accordance with the manufacturer's specifications and drawings using the tools indicated in the technical documentation of this European technical approval,
- checks before placing the anchor to ensure that the strength class of the concrete in which the anchor is to be placed is in the range given and is not lower than that of the concrete to which the characteristic loads apply,
- check of concrete being well compacted, e.g. without significant voids,
- Edge distance and spacing not less than the specified values without minus tolerances,
- positioning of the drill holes without damaging the reinforcement,
- in case of aborted drill hole: the drill hole shall be filled with mortar,
- cleaning the drill hole by at least 4x blowing / 4x brushing / 4x blowing,
- the anchor must not be installed in flooded holes,
- keeping the effective anchorage depth,
- the anchor component installation temperature shall be at least +5 °C,
- the temperature of the concrete during installation and curing of the chemical mortar must not fall below -5 °C;
- the curing time according to Annex 3 shall be observed before the anchor may be loaded,
- after the curing time fixing the member to be anchored by using a calibrated torque wrench by not exceeding the torque moment given in Annex 5.

5 Indications to the manufacturer

5.1 Responsibility of the manufacturer

The manufacturer is responsible to ensure that the information on the specific conditions according to 1 and 2 including Annexes referred to and 4.2 and 4.3 as well as 5 is given to those who are concerned. This information may be made by reproduction of the respective parts of the European technical approval. In addition all installation data shall be shown clearly on the package and/or on an enclosed instruction sheet, preferably using illustration(s).

The minimum data required are:

- drill bit diameter,
- hole depth,
- minimum effective anchorage depth,
- information on the installation procedure, including cleaning of the hole with the cleaning equipments, preferably by means of an illustration,
- anchor component installation temperature,

- ambient temperature of the concrete during installation of the anchor,
- admissible processing time (open time) of the mortar,
- curing time until the anchor may be loaded as a function of the ambient temperature in the concrete during installation,
- torque moment,
- identification of the manufacturing batch.

All data shall be presented in a clear and explicit form.

5.2 Recommendations concerning packaging, transport and storage

The injection cartridges shall be protected against sun radiation and shall be stored according to the manufacturer's installation instructions in dry condition at temperatures of at least +5 °C to not more than +25 °C.

Mortar cartridges with expired shelf life must no longer be used.

Dipl.-Ing. Georg Feistel
Head of Division Construction Engineering
of Deutsches Institut für Bautechnik
Berlin, 8 March 2010

beglaubigt:
Lange

Sealing cap **Cartridge: Injection mortar STV / ALV or STV / ALV Express**

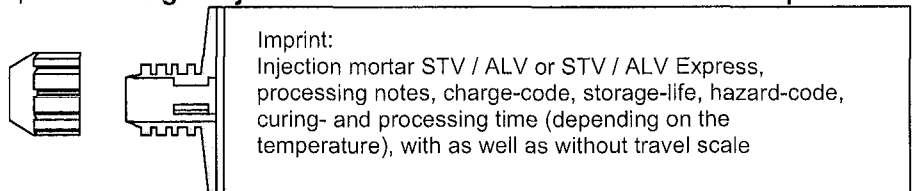

Static mixer

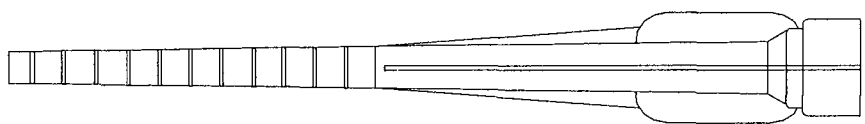

Anchor rod with washer and hexagon nut

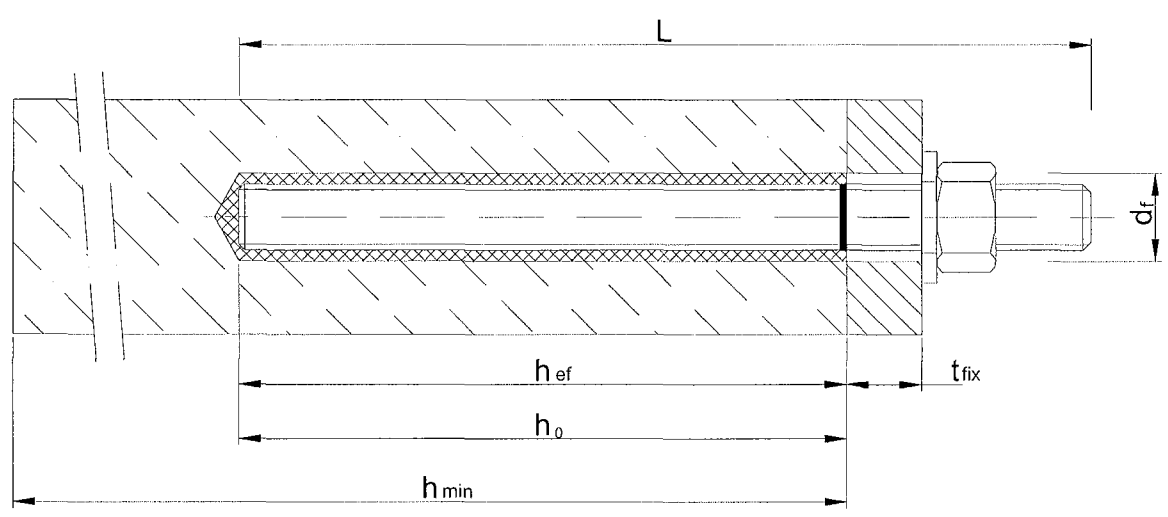
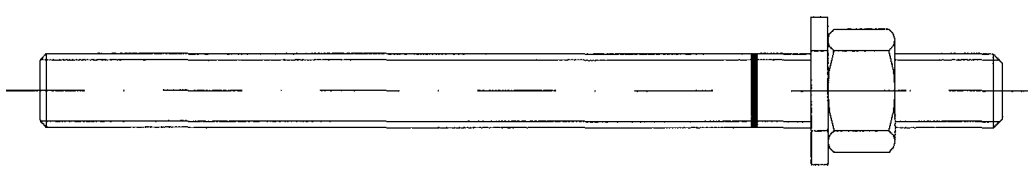

- Use category:
- Installation in dry or wet concrete
 - Service in dry internal conditions
 - No overhead installation

- Temperature range:
- 40°C to +80°C (max. short term temperature +80°C and max. long term temperature +50°C)
 - 40°C to +120°C (max. short term temperature +120°C and max. long term temperature +72°C)

Chemofast Injection System STV / ALV	Annex 1
Product and intended use	of European Technical Approval ETA-05/0023

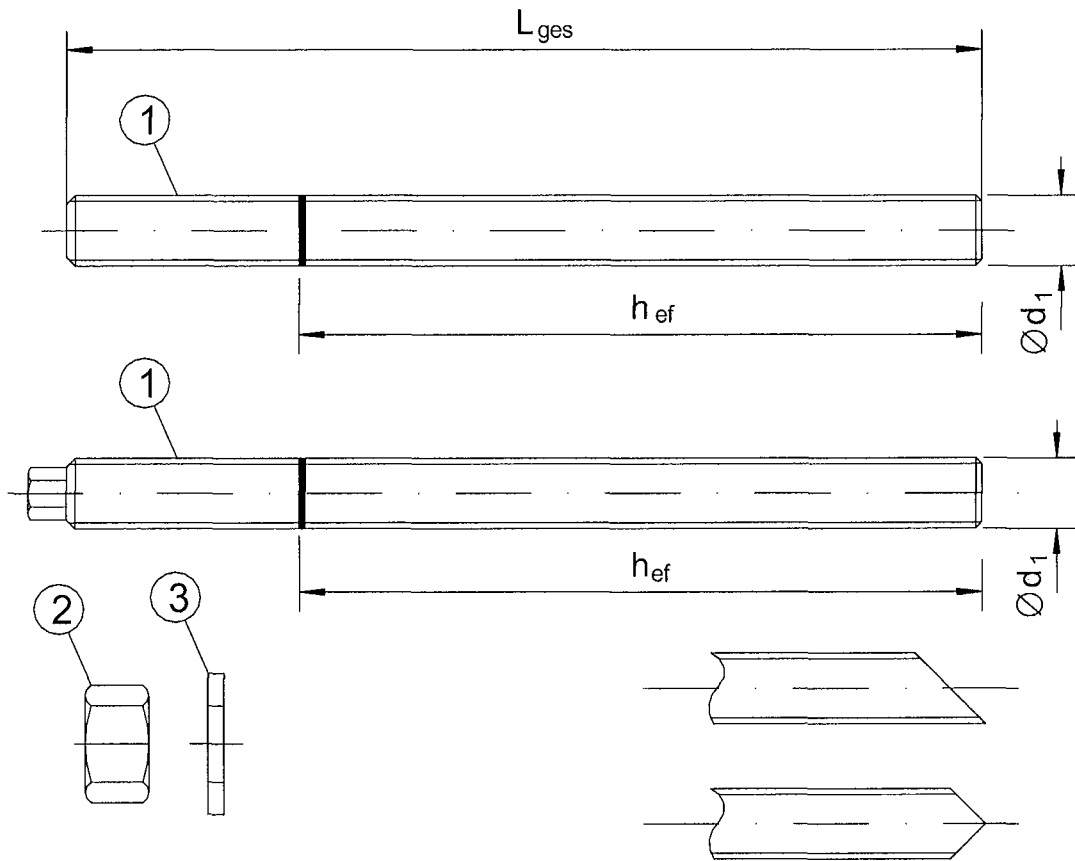

Commercial standard rod with:

- Mechanical properties acc. specifications annex 3, table 2
- Inspection certificate acc. to EN 10204:2004
- Identifying mark of the producer, e.g.: CVM
- Marking of embedment depth

Designation of anchor parts is given in Annex 3 (Table 2).

Table 1: Anchor dimensions

Size	Anchor rod		
	$\varnothing d_1$ [mm]	h_{ef} [mm]	min L ¹⁾ [mm]
M 10	10	90	≥ 110
M 12	12	110	≥ 130
M 16	16	125	≥ 145

¹⁾ max L = 1500 mm

Chemofast Injection System STV / ALV

Anchor dimensions

Annex 2

of European
Technical Approval

ETA-05/0023

Table 2: Materials

Part	Designation	Material
Steel, zinc plated $\geq 5 \mu\text{m}$ acc. to EN ISO 4042 or Steel, hot-dip $\geq 40 \mu\text{m}$ acc. to EN ISO 1461		
1	Anchor rod	Steel acc. DIN EN 10087 or DIN EN 10263 Property class 5.8, 8.8 acc. EN ISO 898-1:1999
2	Hexagon nut according to DIN 934 or DIN EN 24032	Property class 5 (for class 5.8 rod) EN 20898-2, Property class 8 (for class 8.8 rod) EN 20898-2
3	Washer acc. to EN ISO 7089, EN ISO 7093, or EN ISO 7094	Steel, zinc plated
Stainless steel		
1	Anchor rod	Material 1.4401 / 1.4571 acc. EN 10088-1:2005, Property class 50, 70 or 80 acc. EN ISO 3506
2	Hexagon nut according to DIN 934 or DIN EN 24032	Material 1.4401 / 1.4571 EN 10088, Property class 50 (for class 50 rod) EN ISO 3506 Property class 70 (for class 70 rod) EN ISO 3506 Property class 80 (for class 80 rod) EN ISO 3506
3	Washer acc. to EN ISO 7089, EN ISO 7093, or EN ISO 7094	Material 1.4401 or 1.4571 acc. EN 10088
High corrosion resistance steel		
1	Anchor rod	Material 1.4529 / 1.4565 acc. EN 10088-1:2005, Property class 50, 70 or 80 acc. EN ISO 3506
2	Hexagon nut according to DIN 934 or DIN EN 24032	Material 1.4529 / 1.4565 EN 10088, Property class 50 (for class 50 rod) EN ISO 3506 Property class 70 (for class 70 rod) EN ISO 3506 Property class 80 (for class 80 rod) EN ISO 3506
3	Washer acc. to EN ISO 7089, EN ISO 7093, or EN ISO 7094	Material 1.4529 / 1.4565 acc. EN 10088

Table 3: Minimum curing time

Concrete temperature	STV / ALV		STV / ALV Express	
	dry concrete	wet concrete	dry concrete	wet concrete
$\geq -5 \text{ }^\circ\text{C}$	6 h	12 h	4 h	8 h
$\geq 0 \text{ }^\circ\text{C}$	3 h	6 h	2 h	4 h
$\geq +5 \text{ }^\circ\text{C}$	2 h	4 h	1 h	2 h
$\geq +10 \text{ }^\circ\text{C}$	80 min	160 min	40 min	80 min
$\geq +20 \text{ }^\circ\text{C}$	45 min	90 min	20 min	40 min
$\geq +30 \text{ }^\circ\text{C}$	25 min	50 min	10 min	20 min
$\geq +35 \text{ }^\circ\text{C}$	20 min	40 min		

Chemofast Injection System STV / ALV

Materials,
Curing times depending on the temperature**Annex 3**
of European
Technical Approval
ETA-05/0023

150 ml, 280 ml, 300 ml, 330 ml, 380 ml and 410 ml injection mortar cartridge (type: coaxial)

Sealing/Screw cap

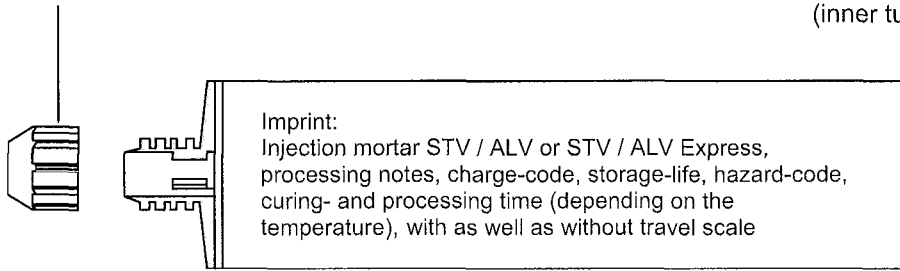

Component B: Hardener
(inner tube)

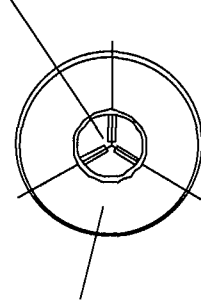

Component A: Injection mortar
(outer tube)

235 ml, 345 ml injection mortar cartridge (type: side-by-side)

Sealing/Screw cap

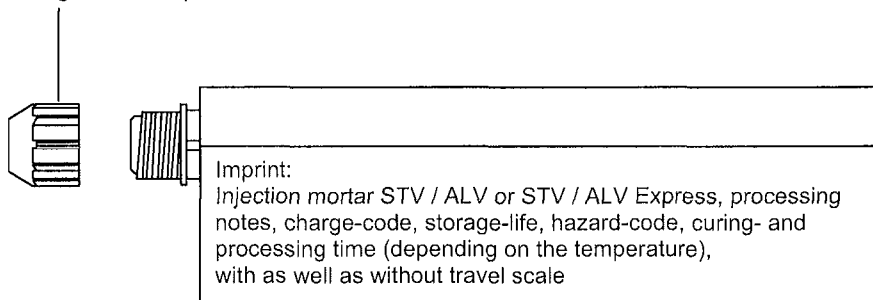

Component B: Hardener

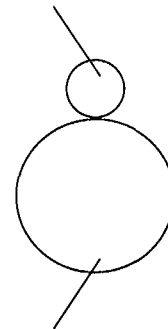

Component A: Injection mortar

165 ml, 300 ml injection mortar cartridge (type: Foil tube)

Sealing/Screw cap

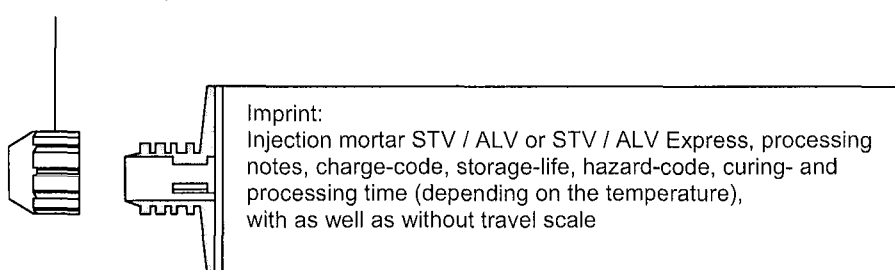

Component B: Hardener
and Component A: Injection
mortar in a foil package

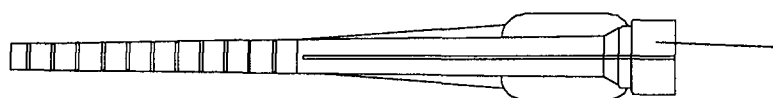
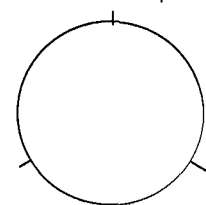

Static Mixer,
one-way tool, must be changed
in case of working interruption

Chemofast Injection System STV / ALV

Mortar cartridges

Annex 4
of European
Technical Approval

ETA-05/0023

Table 4: Installation parameters

Anchor size		M 10	M 12	M 16
Nominal drill hole diameter	d_0 [mm] =	12	14	18
Cutting diameter of drill bit	d_{cut} [mm] ≤	12.5	14.5	18.5
Depth of drill hole	h_0 [mm] ≥	90	110	125
Diameter of clearance hole in the fixture	d_f [mm] ≤	12	14	18
Diameter of steel brush	d_b [mm] ≥	14	16	20
Torque moment	T_{inst} [Nm]	20	40	60
Thickness of fixture	$min t_{fix}$ [mm] >	0		
	$max t_{fix}$ [mm] <	1400	1380	1360
Minimum thickness of member	h_{min} [mm]	130	160	160
Minimum spacing	s_{min} [mm]	90	110	125
Minimum edge distance	c_{min} [mm]	45	55	62.5

Steel brush

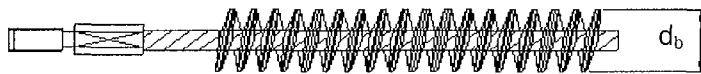

Hand blowout pump

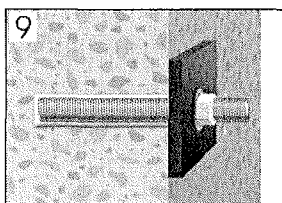
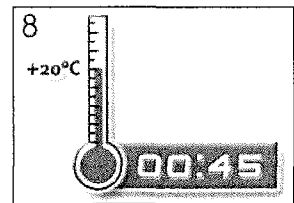
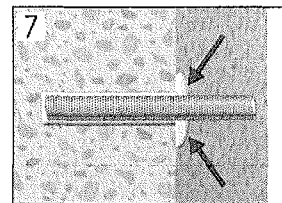
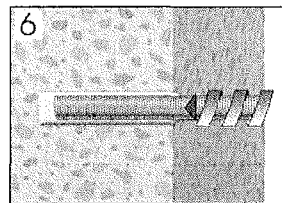
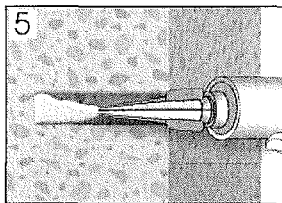
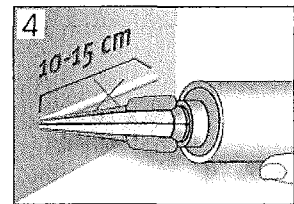
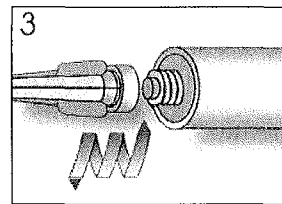
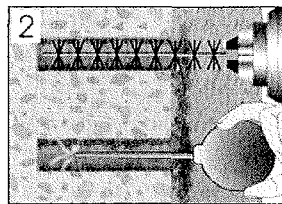
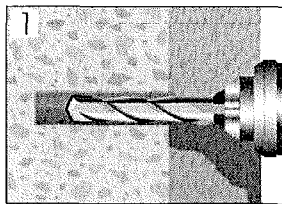

Chemofast Injection System STV / ALV

Installation parameters

Annex 5
of European
Technical Approval

ETA-05/0023

**Table 5: Design method A:
Characteristic values for tension loads**

Anchor size		M 10	M 12	M 16	
Steel failure					
Property class 5.8 acc. to EN ISO 898-1	Characteristic resistance	$N_{Rk,s}$ [kN]	29	42	78
	Partial safety factor	$\gamma_{Ms}^{1)}$	1,50		
Property class 8.8 acc. to EN ISO 898-1	Characteristic resistance	$N_{Rk,s}$ [kN]	46	67	126
	Partial safety factor	$\gamma_{Ms}^{1)}$	1,50		
Property class 50 acc. to EN ISO 3506	Characteristic resistance	$N_{Rk,s}$ [kN]	29	42	78
	Partial safety factor	$\gamma_{Ms}^{1)}$	2,86		
Property class 70 acc. to EN ISO 3506	Characteristic resistance	$N_{Rk,s}$ [kN]	40	59	110
	Partial safety factor	$\gamma_{Ms}^{1)}$	1,87		
Property class 80 acc. to EN ISO 3506	Characteristic resistance	$N_{Rk,s}$ [kN]	46	67	126
	Partial safety factor	$\gamma_{Ms}^{1)}$	1,60		
Pullout and Concrete cone failure					
Non-cracked concrete C20/25 (50 °C / 80 °C) ³⁾		$N_{Rk,c}^0 = N_{Rk,p}$ [kN]	20	25	35
Non-cracked concrete C20/25 (72 °C / 120 °C) ³⁾		$N_{Rk,c}^0 = N_{Rk,p}$ [kN]	16	20	30
Increasing factors for non-cracked concrete Ψ_c		C30/37	1.22		
		C40/50	1.41		
		C50/60	1.55		
Effective anchorage depth		h_{ef} [mm]	90	110	125
Characteristic edge distance		$c_{cr,N}$ [mm]	90	110	125
Characteristic spacing		$s_{cr,N}$ [mm]	180	220	250
Partial safety factor		$\gamma_{Mc} = \gamma_{Mp}^{1)}$	1.8 ²⁾		
Splitting failure					
Spacing		$s_{cr,sp}$ [mm]	180	220	250
Edge distance		$c_{cr,sp}$ [mm]	90	110	125
Partial safety factor		$\gamma_{Msp}^{1)}$	1.8 ²⁾		

¹⁾ In absence of other national regulations

²⁾ The partial safety factor $\gamma_2 = 1.2$ is included.

³⁾ Maximum long term temperature/ maximum short term temperature

Table 6: Displacements for tension loads

Anchor size		M 10	M 12	M 16
Tension load	N [kN]	6.6	8.3	11.6
Displacement	δ_{N0} [mm]	0.3	0.5	0.4
	$\delta_{N\infty}$ [mm]	0.6	1.6	2.0

Chemofast Injection System STV / ALV

Design Method A:
Characteristic values for tension loads,**Annex 6**of European
Technical Approval**ETA-05/0023**

**Table 7: Design method A:
Characteristic values for shear loads**

Anchor size		M 10	M 12	M 16	
Steel failure without lever arm					
Property class 5.8 acc. to EN ISO 898-1	Characteristic resistance	$V_{Rk,s}$ [kN]	14	21	39
	Partial safety factor	$\gamma_{Ms}^{1)}$	1,25		
Property class 8.8 acc. to EN ISO 898-1	Characteristic resistance	$V_{Rk,s}$ [kN]	23	33	63
	Partial safety factor	$\gamma_{Ms}^{1)}$	1,25		
Property class 50 acc. to EN ISO 3506	Characteristic resistance	$V_{Rk,s}$ [kN]	14	21	39
	Partial safety factor	$\gamma_{Ms}^{1)}$	2,38		
Property class 70 acc. to EN ISO 3506	Characteristic resistance	$V_{Rk,s}$ [kN]	20	29	55
	Partial safety factor	$\gamma_{Ms}^{1)}$	1,56		
Property class 80 acc. to EN ISO 3506	Characteristic resistance	$V_{Rk,s}$ [kN]	23	33	62
	Partial safety factor	$\gamma_{Ms}^{1)}$	1,33		
Steel failure with lever arm					
Property class 5.8 acc. to EN ISO 898-1	Characteristic resistance	$M^0_{Rk,s}$ [Nm]	37	65	166
	Partial safety factor	$\gamma_{Ms}^{1)}$	1,25		
Property class 8.8 acc. to EN ISO 898-1	Characteristic resistance	$M^0_{Rk,s}$ [Nm]	60	105	266
	Partial safety factor	$\gamma_{Ms}^{1)}$	1,25		
Property class 50 acc. to EN ISO 3506	Characteristic resistance	$M^0_{Rk,s}$ [Nm]	37	65	166
	Partial safety factor	$\gamma_{Ms}^{1)}$	2,38		
Property class 70 acc. to EN ISO 3506	Characteristic resistance	$M^0_{Rk,s}$ [Nm]	52	92	233
	Partial safety factor	$\gamma_{Ms}^{1)}$	1,56		
Property class 80 acc. to EN ISO 3506	Characteristic resistance	$M^0_{Rk,s}$ [Nm]	60	105	266
	Partial safety factor	$\gamma_{Ms}^{1)}$	1,33		
Concrete pryout failure					
Factor k in equation (5.6) of ETAG 001, Annex C, Section 5.2.3.3			2.0		
Partial safety factor			$\gamma_{Mc}^{1)}$ 1.50 ²⁾		
Concrete edge failure					
Effective length of anchor in shear loading		l_f [mm]	90	110	125
Outside diameter of anchor		d_{nom} [mm]	12	14	18
Partial safety factor			$\gamma_{Mc}^{1)}$ 1.50 ²⁾		

¹⁾ If no other national regulations exist

²⁾ The partial safety factor $\gamma_2 = 1.0$ is included.

Table 8: Displacements for shear loads

Anchor size		M 10	M 12	M 16
Shear load	V [kN]	6.6	8.3	11.6
Displacement	δ_{V0} [mm]	0.4	1.1	1.3
	$\delta_{V\infty}$ [mm]	0.6	1.6	2.0

Chemofast Injection System STV / ALV

Design Method A:
Characteristic values for shear loads,**Annex 7**of European
Technical Approval**ETA-05/0023**