

Deutsches Institut für Bautechnik

Anstalt des öffentlichen Rechts

Kolonnenstr. 30 L
10829 Berlin
Germany

Tel.: +49(0)30 787 30 0
Fax: +49(0)30 787 30 320
E-mail: dibt@dibt.de
Internet: www.dibt.de

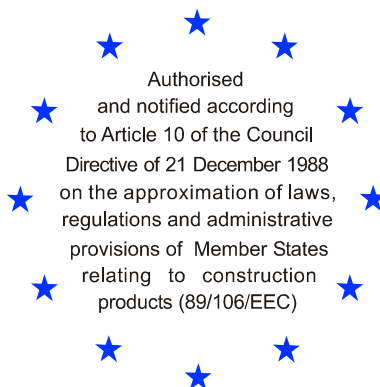

DIBt

Mitglied der EOTA
Member of EOTA

European Technical Approval ETA-05/0181

English translation prepared by DIBt - Original version in German language

Handelsbezeichnung
Trade name

Berner CONTACTanchor

Zulassungsinhaber
Holder of approval

Berner GmbH
Bernerstraße 6
74653 Künzelsau
DEUTSCHLAND

Zulassungsgegenstand
und Verwendungszweck

Wegkontrolliert spreizender Dübel aus galvanisch verzinktem Stahl in den Größen M6, M8, M10 und M12 für die Verwendung als Mehrfachbefestigung von nichttragenden Systemen in Beton

*Generic type and use
of construction product*

Deformation-controlled expansion anchor made of galvanised steel of sizes M6, M8, M10 and M12 for multiple use for non-structural applications in concrete

Geltungsdauer:
Validity:

vom
from
bis
to
verlängert vom
extended from
bis
to

8 September 2005
24 August 2010
25 August 2010
16 August 2015

Herstellwerk
Manufacturing plant

Berner Herstellwerk 3, Deutschland

Diese Zulassung umfasst
This Approval contains

13 Seiten einschließlich 6 Anhänge
13 pages including 6 annexes



Europäische Organisation für Technische Zulassungen
European Organisation for Technical Approvals

I LEGAL BASES AND GENERAL CONDITIONS

- 1 This European technical approval is issued by Deutsches Institut für Bautechnik in accordance with:
 - Council Directive 89/106/EEC of 21 December 1988 on the approximation of laws, regulations and administrative provisions of Member States relating to construction products¹, modified by Council Directive 93/68/EEC² and Regulation (EC) N° 1882/2003 of the European Parliament and of the Council³;
 - Gesetz über das In-Verkehr-Bringen von und den freien Warenverkehr mit Bauprodukten zur Umsetzung der Richtlinie 89/106/EWG des Rates vom 21. Dezember 1988 zur Angleichung der Rechts- und Verwaltungsvorschriften der Mitgliedstaaten über Bauprodukte und anderer Rechtsakte der Europäischen Gemeinschaften (Bauproduktengesetz - BauPG) vom 28. April 1998⁴, as amended by law of 31 October 2006⁵;
 - Common Procedural Rules for Requesting, Preparing and the Granting of European technical approvals set out in the Annex to Commission Decision 94/23/EC⁶;
 - Guideline for European technical approval of "Metal anchors for use in concrete - Part 6: Anchors for multiple use for non-structural applications", ETAG 001-06.
- 2 Deutsches Institut für Bautechnik is authorized to check whether the provisions of this European technical approval are met. Checking may take place in the manufacturing plant. Nevertheless, the responsibility for the conformity of the products to the European technical approval and for their fitness for the intended use remains with the holder of the European technical approval.
- 3 This European technical approval is not to be transferred to manufacturers or agents of manufacturers other than those indicated on page 1, or manufacturing plants other than those indicated on page 1 of this European technical approval.
- 4 This European technical approval may be withdrawn by Deutsches Institut für Bautechnik, in particular pursuant to information by the Commission according to Article 5(1) of Council Directive 89/106/EEC.
- 5 Reproduction of this European technical approval including transmission by electronic means shall be in full. However, partial reproduction can be made with the written consent of Deutsches Institut für Bautechnik. In this case partial reproduction has to be designated as such. Texts and drawings of advertising brochures shall not contradict or misuse the European technical approval.
- 6 The European technical approval is issued by the approval body in its official language. This version corresponds fully to the version circulated in EOTA. Translations into other languages have to be designated as such.

1 Official Journal of the European Communities N° L 40, 11 February 1989, p. 12

2 Official Journal of the European Communities N° L 220, 30 August 1993, p. 1

3 Official Journal of the European Union N° L 284, 31 October 2003, p. 25

4 *Bundesgesetzblatt Teil I* 1998, p. 812

5 *Bundesgesetzblatt Teil I* 2006, p. 2407, 2416

6 Official Journal of the European Communities N° L 17, 20 January 1994, p. 34

II SPECIFIC CONDITIONS OF THE EUROPEAN TECHNICAL APPROVAL

1 Definition of the construction product and intended use

1.1 Definition of the product

The Berner CONTACTanchor of sizes M6, M8, M8x40, M10 and M12 is an anchor made of galvanised steel which is placed into a drilled hole and anchored by deformation-controlled expansion.

The product (types, sizes) and an illustration of the installed anchor are given in Annex 1.

The fixture shall be anchored with a fastening screw or threaded rod according to Annex 4.

1.2 Intended use

The anchor is intended to be used for anchorages for which requirements for safety in use in the sense of the Essential Requirements 4 of Council Directive 89/106 EEC shall be fulfilled and failure of the fixture represents an immediate risk to human life. The anchor is to be used only for multiple use for non-structural applications. The definition of multiple use according to the Member States is given in the informative Annex 1 of ETAG 001, Part 6.

The anchor may be used for anchorages with requirements related to resistance to fire.

The anchor is to be used only for anchorages subject to static or quasi-static loading in reinforced or unreinforced normal weight concrete of strength classes C20/25 at minimum and C50/60 at most according to EN 206-1:2000-12.

The anchor may be anchored in cracked or non-cracked concrete.

The anchor may only be used in structures subject to dry internal conditions.

The provisions made in this European technical approval are based on an assumed working life of the anchor of 50 years. The indications given on the working life cannot be interpreted as a guarantee given by the producer, but are to be regarded only as a means for choosing the right products in relation to the expected economically reasonable working life of the works.

2 Characteristics of product and methods of verification

2.1 Characteristics of product

The anchor corresponds to the drawings and provisions given in Annex 2. The characteristic material values, dimensions and tolerances of the anchor not given in Annex 2 shall correspond to the respective values laid down in the technical documentation⁷ of this European technical approval.

Regarding the requirements concerning safety in case of fire it is assumed that the anchor meets the requirements of class A1 in relation to reaction to fire in accordance with the stipulations of the Commission decision 96/603/EC, amended by 2000/605/EC.

The characteristic values for the design of anchorages are given in Annex 5, Table 5.

The characteristic anchor values for the design of the anchorages regarding resistance to fire are given in Annex 5, Table 6. They are valid for use in a system that is required to provide a specific fire resistance class.

In addition to the specific clauses relating to dangerous substances contained in this European technical approval, there may be other requirements applicable to the products falling within its scope (e.g. transposed European legislation and national laws, regulations and administrative provisions). In order to meet the provisions of the Construction Products Directive, these requirements need also to be complied with, when and where they apply.

⁷ The technical documentation of this European technical approval is deposited at the Deutsches Institut für Bautechnik and, as far as relevant for the tasks of the approved bodies involved in the attestation of conformity procedure, is handed over to the approved bodies.

Each anchor is marked with the identifying mark of the manufacturing plant, the anchor type and the thread size according to Annex 2.

In addition, the expansion sleeve for anchor size M8 x 40 is marked on the top of the sleeve. The anchor shall only be packaged and supplied as a complete unit.

2.2 Methods of verification

The assessment of fitness of the anchor for the intended use in relation to the requirements for safety in use in the sense of the Essential Requirements 4 has been made in accordance with the "Guideline for European technical approval of Metal Anchors for Use in Concrete", Part 1 "Anchors in general" and Part 6 "Anchors for multiple use for non-structural applications".

The assessment of the anchor for the intended use in relation to the requirements for resistance to fire has been made in accordance with the Technical Report TR 020 "Evaluation of anchorages in concrete concerning resistance to fire".

In addition to the specific clauses relating to dangerous substances contained in this European technical approval, there may be other requirements applicable to the products falling within its scope (e.g. transposed European legislation and national laws, regulations and administrative provisions). In order to meet the provisions of the Construction Products Directive, these requirements need also to be complied with, when and where they apply.

3 Evaluation and attestation of conformity and CE marking

3.1 System of attestation of conformity

According to the decision 97/161/EG of the European Commission⁸ the system 2(ii) (referred to as system 2+) of attestation of conformity applies.

This system of attestation of conformity is defined as follows:

System 2+: Declaration of conformity of the product by the manufacturer on the basis of:

- (a) Tasks for the manufacturer:
 - (1) initial type-testing of the product;
 - (2) factory production control;
 - (3) testing of samples taken at the factory in accordance with a prescribed control plan.
- (b) Tasks for the approved body:
 - (4) certification of factory production control on the basis of:
 - initial inspection of factory and of factory production control;
 - continuous surveillance, assessment and approval of factory production control.

Note: Approved bodies are also referred to as "notified bodies".

3.2 Responsibilities

3.2.1 Tasks of the manufacturer

3.2.1.1 Factory production control

The manufacturer shall exercise permanent internal control of production. All the elements, requirements and provisions adopted by the manufacturer shall be documented in a systematic manner in the form of written policies and procedures, including records of results performed. This production control system shall insure that the product is in conformity with this European technical approval.

The manufacturer may only use initial / raw / constituent materials stated in the technical documentation of this European technical approval.

⁸ Official Journal of the European Communities L 67 of 03.02.1997

The factory production control shall be in accordance with the control plan which is part of the technical documentation of this European technical approval. The control plan is laid down in the context of the factory production control system operated by the manufacturer and deposited at Deutsches Institut für Bautechnik.⁹

The results of factory production control shall be recorded and evaluated in accordance with the provisions of the control plan.

3.2.1.2 Other tasks of manufacturer

The manufacturer shall, on the basis of a contract, involve a body which is approved for the tasks referred to in section 3.1 in the field of the anchor in order to undertake the actions laid down in section 3.3. For this purpose, the control plan referred to in sections 3.2.1.1 and 3.2.2 shall be handed over by the manufacturer to the approved body involved.

The manufacturer shall make a declaration of conformity, stating that the construction product is in conformity with the provisions of this European technical approval.

3.2.2 Tasks of approved bodies

The approved body shall perform the

- initial inspection of factory and of factory production control,
- continuous surveillance, assessment and approval of factory production control.

in accordance with the provisions laid down in the control plan relating to this European technical approval.

The approved body shall retain the essential points of its actions referred to above and state the results obtained and conclusions drawn in a written report.

The approved certification body involved by the manufacturer shall issue an EC certificate of conformity of the factory production control stating the conformity with the provisions of this European technical approval.

In cases where the provisions of the European technical approval and its control plan are no longer fulfilled the certification body shall withdraw the certificate of conformity and inform Deutsches Institut für Bautechnik without delay.

3.3 CE marking

The CE marking shall be affixed on each packing of the anchor. The letters "CE" shall be followed by the identification number of the approved certification body, where relevant, and be accompanied by the following additional information:

- the name and address of the producer (legal entity responsible for the manufacture),
- the last two digits of the year in which the CE marking was affixed,
- the number of the EC certificate for the factory production,
- the number of the European technical approval,
- the number of the guideline for European technical approval,
- use category (ETAG 001-6),
- size.

⁹ The control plan is a confidential part of the European technical approval and only handed over to the approved body involved in the procedure of attestation of conformity. See section 3.2.2.

4 Assumptions under which the fitness of the product for the intended use was favourably assessed

4.1 Manufacturing

The European technical approval is issued for the product on the basis of agreed data/information, deposited with Deutsches Institut für Bautechnik, which identifies the product that has been assessed and judged. Changes to the product or production process, which could result in this deposited data/information being incorrect, should be notified to Deutsches Institut für Bautechnik before the changes are introduced. Deutsches Institut für Bautechnik will decide whether or not such changes affect the European technical approval and consequently the validity of the CE marking on the basis of the European technical approval and if so whether further assessment or alterations to the European technical approval shall be necessary.

4.2 Design of anchorages

The fitness of the anchor for the intended use is given under the following conditions:

The anchorages are designed in accordance with the "Guideline for European technical approval of Metal Anchors for Use in Concrete", Annex C, Method B, for deformation-controlled expansion anchors under the responsibility of an engineer experienced in anchorages and concrete work.

Verifiable calculation notes and drawings are prepared taking account of the loads to be anchored.

The position of the anchor is indicated on the design drawings (e.g. position of the anchor relative to reinforcement or to supports).

The strength class and the length of the fastening screw or threaded rod shall be defined by the designing engineer. The choice of the length shall account for the available thread length, the minimum screwing depth, the thickness of fixture and tolerances of member and fixture. The strength class and the minimum screwing depth of the fastening screw or threaded rod shall be met the requirements according to Annex 4.

The design of anchorages under fire exposure has to consider the conditions given in the Technical Report TR 020 "Evaluation of anchorages in concrete concerning resistance to fire". The relevant characteristic values are given in Annex 5, Table 6. The design method covers anchors with a fire attack from one side only. If the fire attack is from more than one side, the design method may be taken only, if the edge distance of the anchor is $c \geq 300$ mm.

4.3 Installation of anchors

The fitness for use of the anchor can only be assumed if the anchor is installed as follows:

- Anchor installation carried out by appropriately qualified personnel and under the supervision of the person responsible for technical matters of the site.
- Use of the anchor only as supplied by the manufacturer without exchanging the components of an anchor.
- Anchor installation in accordance with the manufacturer's specifications and drawings and using the appropriate tools.
- Checks before placing the anchor to ensure that the strength class of the concrete in which the anchor is to be placed is in the range given and is not lower than that of the concrete to which the characteristic loads apply.
- Check of concrete being well compacted, e.g. without significant voids.
- Edge distances and spacings not less than the specified values without minus tolerances.
- Positioning of the drill holes without damaging the reinforcement.

- In case of aborted hole: new drilling at a minimum distance away of twice the depth of the aborted hole or smaller distance if the aborted drill hole is filled with high strength mortar and if under shear or oblique tension load it is not in the direction of load application.
- Cleaning of the drill hole.
- Anchor installation such that the effective setting depth is complied with. This compliance is ensured, if the expansion sleeve does not exceed the concrete surface.
- Anchor expansion by impact on the cone using the setting tools given in Annex 3. The anchor is properly set if the stop of the pin reaches the expansion sleeve and the impression of the setting tool for marking is visible as illustrated in Annex 3.
- The fastening screw or threaded rod shall correspond to the requirements given in Annex 4.
- Application of the torque moment given in Annex 4 using a calibrated torque wrench.

5 Responsibility of the manufacturer

The manufacturer is responsible to ensure that the information on the specific conditions according to 1 and 2 including Annexes referred to as well as sections 4.2 and 4.3 is given to those who are concerned. This information may be made by reproduction of the respective parts of the European technical approval. In addition all installation data shall be shown clearly on the package and/or on an enclosed instruction sheet, preferably using illustration(s).

The minimum data required are:

- drill bit diameter,
- thread diameter,
- minimum effective anchorage depth,
- available thread length and minimum screwing depth of the fastening screw or threaded rod,
- minimum hole depth,
- torque moment,
- information on the installation procedure, including cleaning of the hole, preferably by means of an illustration,
- reference to any special installation equipment needed,
- identification of the manufacturing batch.

All data shall be presented in a clear and explicit form.

Georg Feistel
Head of Department

beglaubigt:
Tempel

Anchor size

M6

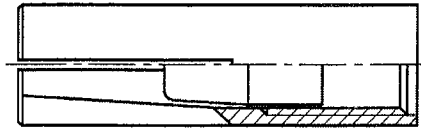

M8, M8x40

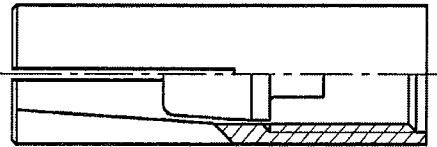

S M8 (with plunged boss)

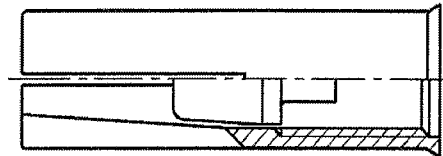

M10, M12

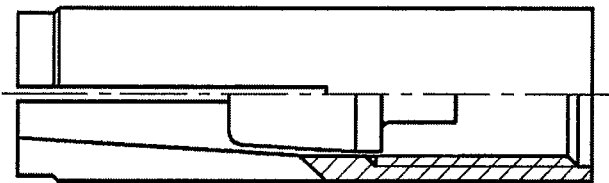

S M10, S M12 (with plunged boss)

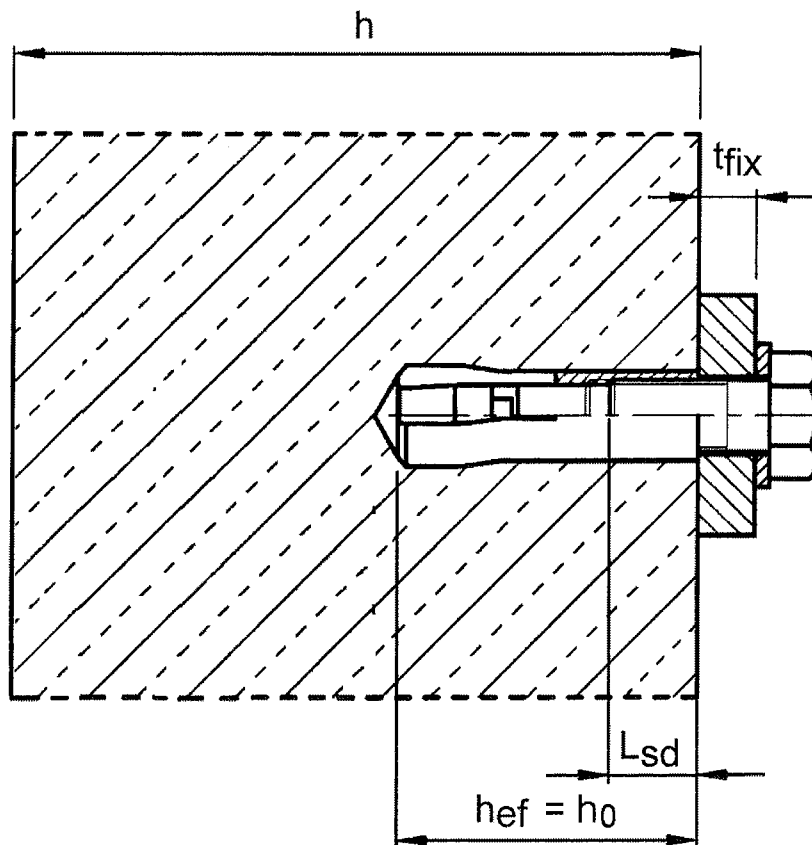
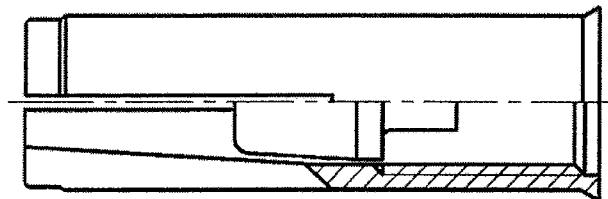

Berner CONTACTanchor

Product and intended use

Annex 1

of European
technical approval

ETA-05/0181

Expansion sleeve

Marking: e.g.: \diamond E M8

\diamond Identifying mark of manufacturing plant

E Anchor identity

M8 Size of thread

Anchor size: M8x40:

additional marking d, visible after installation

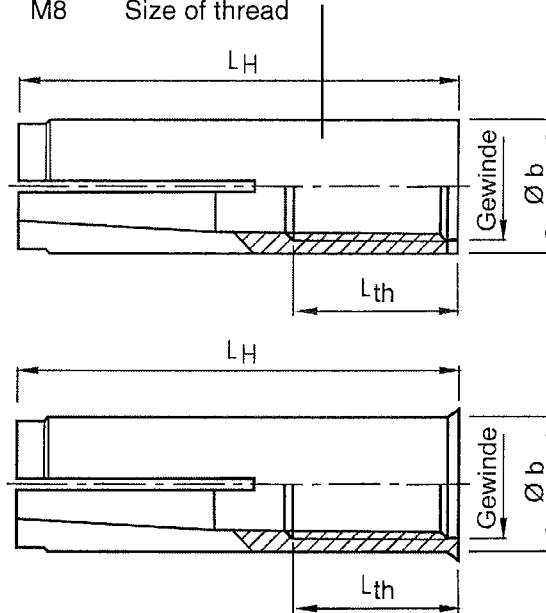
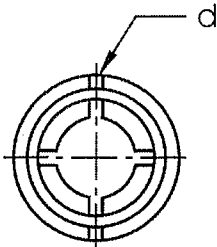

Cone

Anchor size M6

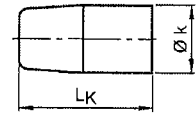

Anchor size M8 – M12

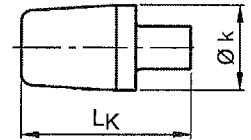

Table 1: Dimensions [mm]

Anchor size	Expansion sleeve				Cone	
	Thread size	Ø b	L _H	L _{th}	Ø k	L _k
M6	M6	8	30	13	5.0	13
M8	M8	10	30	13	6.5	12
M8x40	M8	10	40	20		
M10	M10	12	40	15	8.2	16
M12	M12	15	50	18	10.3	20

Table 2: Designation of anchor parts and materials

Part	Designation	Materials, zinc coated $\geq 5 \mu\text{m}$, acc. to EN ISO 4042
1	Expansion sleeve	Free-cutting steel acc. to EN 10087
2	Cone	Steel for cold forming acc. to EN 10263

Berner CONTACTanchor

Annex 2

Dimensions, Designations of anchor parts and materials

of European technical approval

ETA-05/0181

Setting tool for marking

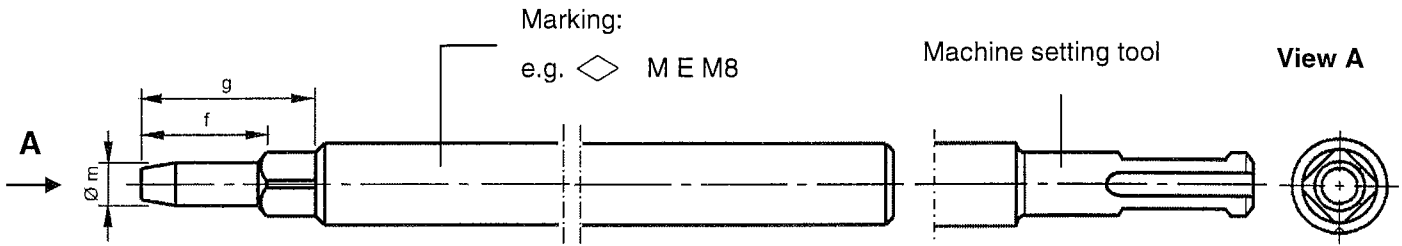

Verification of correct installation

Visible marking after correct installation

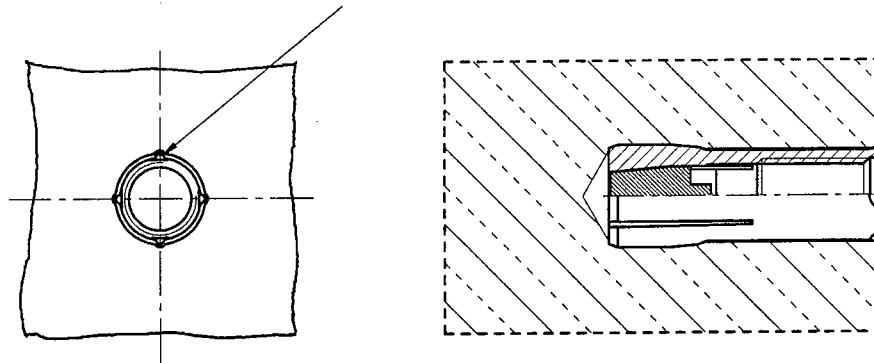

Setting tool

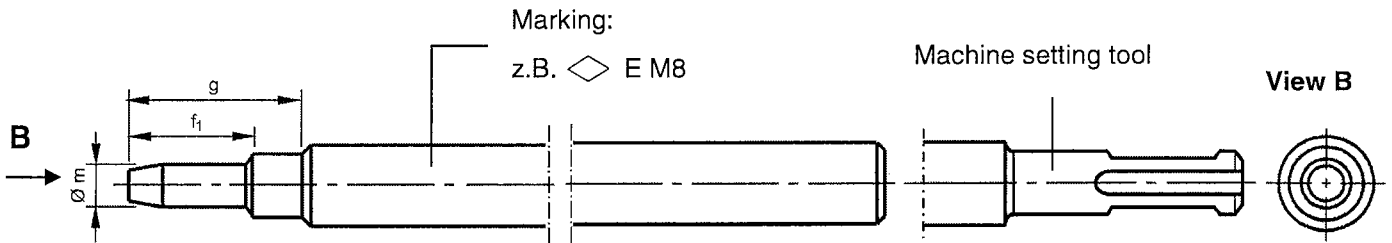

Table 3: Dimensions of setting tools [mm]

Anchor size	Ø m	f	f ₁	g
M6	4.9	-	17	27
M8	6.4	18.2	18	28
M8x40	6.4	28.2	28	38
M10	8.0	24.2	24	34
M12	10.0	30.4	30	40

Berner CONTACTanchor

Dimensions of setting tools and verification of correct installation

Annex 3

of European technical approval

ETA-05/0181

Table 4: Installation parameters

Anchor size			M6	M8	M8x40	M10	M12
Drill hole diameter	$d_0 =$	[mm]	8	10	10	12	15
Cutting diameter of drill bit	$d_{cut} \leq$	[mm]	8.45	10.45	10.45	12.5	15.5
Depth of drill hole	h_0	[mm]	30	30	40	40	50
Recommended installation torque	$T_{inst} \leq$	[Nm]	4	8	8	15	35
Diameter of clearance hole in the fixture	$d_f \leq$	[mm]	7	9	9	12	14
Available thread length	L_{th}	[mm]	13	13	20	15	18
Minimum screw-in depth	L_{sdmin}	[mm]	7	9	9	11	13
Minimum thickness of member	h_{min}	[mm]	100	100	100	120	130
Minimum spacing and edge distance	s_{min}	[mm]	55	60	80	100	120
	c_{min}	[mm]	95	95	95	135	165
Characteristic spacing and edge distance	s_{cr}	[mm]	130	180	210	170	170
	c_{cr}	[mm]	65	90	105	85	85

For requirements on fire resistance, see Annex 5.

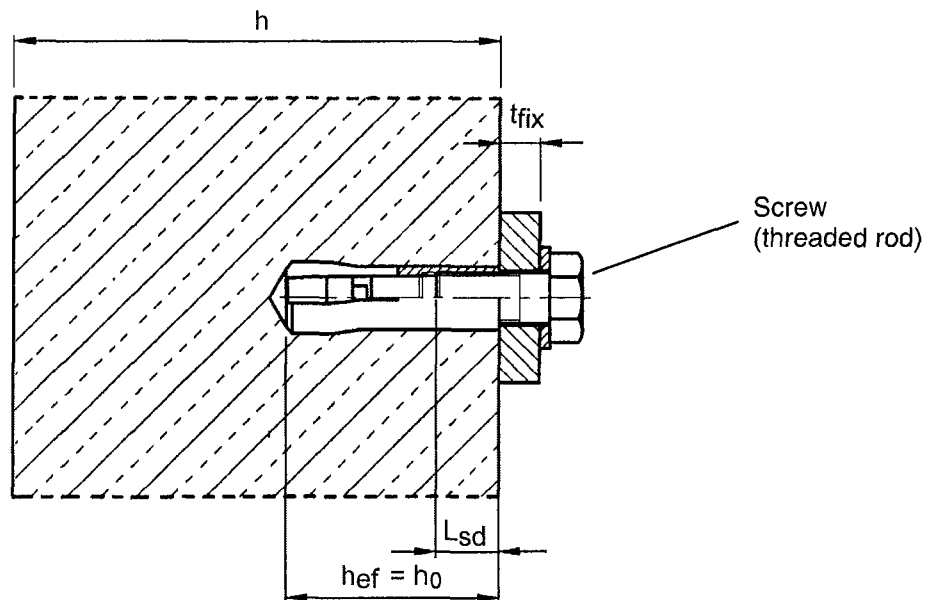

Requirements for the fastening screw or threaded rod according to the engineering documents:

- Strength class 4.6, 5.6, 5.8 or 8.8 according to EN ISO 898-1;
- Minimum screw-in depth L_{sdmin} see Table 4;
- The length of the fastening screw shall be determined on thickness of fixture t_{fix} , admissible tolerances, available thread length L_{th} (= maximum screw-in depth) and minimum screw-in depth L_{sdmin} .

Berner CONTACTanchor

Installation parameters

Annex 4

of European
technical approval

ETA-05/0181

Table 5: Design method B – Characteristic values of resistance

Anchor size			M6	M8	M8x40	M10	M12
In any load direction							
Characteristic resistance in concrete C20/25 to C50/60	F_{Rk}^0 ¹⁾	[kN]	3	5	6	6	6
Partial safety factor	γ_M ²⁾		1.8 ³⁾	2.16 ³⁾			1.8 ³⁾
Shear load with lever arm							
Characteristic resistance (Steel 4.6)	$M_{Rk,s}^0$ ⁴⁾	[Nm]	6.1	15	15	30	52
Partial safety factor	γ_{Ms} ²⁾	[-]	1.67				
Characteristic resistance (Steel 5.6)	$M_{Rk,s}^0$ ⁴⁾	[Nm]	7.6	19	19	37	65
Partial safety factor	γ_{Ms} ²⁾	[-]	1.67				
Characteristic resistance (Steel 5.8)	$M_{Rk,s}^0$ ⁴⁾	[Nm]	7.6	19	19	37	65
Partial safety factor	γ_{Ms} ²⁾	[-]	1.25				
Characteristic resistance (Steel 8.8)	$M_{Rk,s}^0$ ⁴⁾	[Nm]	12	30	30	60	105
Partial safety factor	γ_{Ms} ²⁾	[-]	1.25				

¹⁾ The anchor may only be applied to multiple use for non-structural applications, the definition of multiple use for the Member States is given in the informative Annex 1 of ETAG 001, Part 6

²⁾ In absence of other national regulations

³⁾ The partial safety factor γ_2 is included

⁴⁾ Characteristic bending moment $M_{Rk,s}^0$ for equation (5.5) in ETAG 001, Annex C

Table 6: Characteristic values under fire exposure in concrete C20/25 to C50/60

Anchor size			M6	M8	M8x40	M10	M12			
Fire resistance class		In any load direction								
Steel 4.6	R 30	Characteristic resistance	$F_{Rk,fi}^0$ ¹⁾	[kN]	0.2	0.4	0.4	0.9	1.7	
	R 60			[kN]	0.2	0.3	0.3	0.8	1.3	
	R 90			[kN]	0.1	0.3	0.3	0.6	1.1	
	R 120			[kN]	0.1	0.2	0.2	0.5	0.8	
Steel ≥ 5.6	R 30	Characteristic resistance	$F_{Rk,fi}^0$ ¹⁾	[kN]	0.8	0.9	0.9	1.5	1.7	
	R 60			[kN]	0.8	0.9	0.9	1.5	1.5	
	R 90			[kN]	0.4	0.9	0.9	1.5	1.5	
	R 120			[kN]	0.2	0.4	0.4	1.0	1.2	
R 30 to R 120	Spacing			$s_{cr,fi}$	[mm]	130	180	210	170	200
				s_{min}	[mm]	55	60	80	100	120
	Edge distance			$c_{cr,fi}$	[mm]	65	90	105	85	100
				c_{min}	[mm]	95	95	95	135	165
If the fire attack is from more than one side, the edge distance shall be ≥ 300 mm.										

¹⁾ In absence of other national regulations the partial safety factor for resistance under fire exposure $\gamma_{M,fi} = 1.0$ is recommended.

Berner CONTACTanchor**Annex 5**

**Design method B,
Characteristic values of resistance,
Characteristic values under fire exposure in
concrete C20/25 to C50/60**

of European
technical approval

ETA-05/0181

Installation instructions

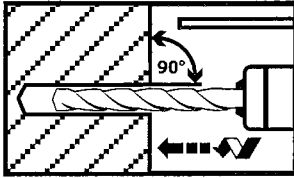

Drill hole perpendicular to concrete surface.

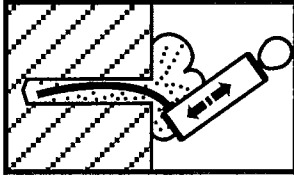

Blow out dust.

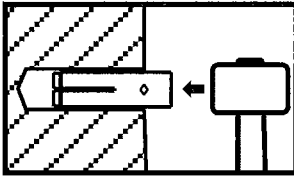

Drive in anchor.

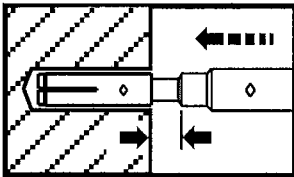

Drive in cone by using setting tool.

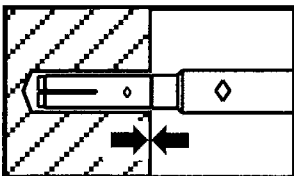

Shoulder of setting tool must fit on anchor rim.

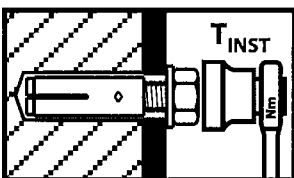

Apply installation torque T_{inst} by using torque wrench.

Berner CONTACTanchor

Installation instructions

Annex 6

of European
technical approval

ETA-05/0181