

Deutsches Institut für Bautechnik

Anstalt des öffentlichen Rechts

Kolonnenstr. 30 L
10829 Berlin
Germany

Tel.: +49(0)30 787 30 0
Fax: +49(0)30 787 30 320
E-mail: dibt@dibt.de
Internet: www.dibt.de



DIBt

Mitglied der EOTA
Member of EOTA

European Technical Approval ETA-06/0047

English translation prepared by DIBt - Original version in German language

Handelsbezeichnung <i>Trade name</i>	Hilti Kompaktdübel HKD <i>Hilti push-in anchor HKD</i>
Zulassungsinhaber <i>Holder of approval</i>	Hilti Aktiengesellschaft Business Unit Anchors 9494 Schaan FÜRSTENTUM LIECHTENSTEIN
Zulassungsgegenstand und Verwendungszweck <i>Generic type and use of construction product</i>	Wegkontrolliert spreizender Dübel in den Größen M6, M8, M10, M12 und M16 für die Verwendung als Mehrfachbefestigung von nichttragenden Systemen in Beton <i>Deformation-controlled expansion anchor of sizes M6, M8, M10, M12 and M16 for multiple use for non-structural applications in concrete</i>
Geltungsdauer: <i>Validity:</i>	vom <i>from</i> 22 April 2010 bis <i>to</i> 14 March 2011
Herstellwerk <i>Manufacturing plant</i>	Hilti Werke

Diese Zulassung umfasst
This Approval contains

18 Seiten einschließlich 10 Anhänge
18 pages including 10 annexes

Diese Zulassung ersetzt
This Approval replaces

ETA-06/0047 mit Geltungsdauer vom 30.11.2007 bis 14.03.2011
ETA-06/0047 with validity from 30.11.2007 to 14.03.2011



Europäische Organisation für Technische Zulassungen
European Organisation for Technical Approvals

I LEGAL BASES AND GENERAL CONDITIONS

- 1 This European technical approval is issued by Deutsches Institut für Bautechnik in accordance with:
 - Council Directive 89/106/EEC of 21 December 1988 on the approximation of laws, regulations and administrative provisions of Member States relating to construction products¹, modified by Council Directive 93/68/EEC² and Regulation (EC) N° 1882/2003 of the European Parliament and of the Council³;
 - Gesetz über das In-Verkehr-Bringen von und den freien Warenverkehr mit Bauprodukten zur Umsetzung der Richtlinie 89/106/EWG des Rates vom 21. Dezember 1988 zur Angleichung der Rechts- und Verwaltungsvorschriften der Mitgliedstaaten über Bauprodukte und anderer Rechtsakte der Europäischen Gemeinschaften (Bauproduktengesetz - BauPG) vom 28. April 1998⁴, as amended by law of 31 October 2006⁵;
 - Common Procedural Rules for Requesting, Preparing and the Granting of European technical approvals set out in the Annex to Commission Decision 94/23/EC⁶;
 - Guideline for European technical approval of "Metal anchors for use in concrete - Part 6: Anchors for multiple use for non-structural applications", ETAG 001-06.
- 2 Deutsches Institut für Bautechnik is authorized to check whether the provisions of this European technical approval are met. Checking may take place in the manufacturing plant. Nevertheless, the responsibility for the conformity of the products to the European technical approval and for their fitness for the intended use remains with the holder of the European technical approval.
- 3 This European technical approval is not to be transferred to manufacturers or agents of manufacturers other than those indicated on page 1, or manufacturing plants other than those indicated on page 1 of this European technical approval.
- 4 This European technical approval may be withdrawn by Deutsches Institut für Bautechnik, in particular pursuant to information by the Commission according to Article 5(1) of Council Directive 89/106/EEC.
- 5 Reproduction of this European technical approval including transmission by electronic means shall be in full. However, partial reproduction can be made with the written consent of Deutsches Institut für Bautechnik. In this case partial reproduction has to be designated as such. Texts and drawings of advertising brochures shall not contradict or misuse the European technical approval.
- 6 The European technical approval is issued by the approval body in its official language. This version corresponds fully to the version circulated within EOTA. Translations into other languages have to be designated as such.

1 Official Journal of the European Communities L 40, 11 February 1989, p. 12

2 Official Journal of the European Communities L 220, 30 August 1993, p. 1

3 Official Journal of the European Union L 284, 31 October 2003, p. 25

4 *Bundesgesetzblatt Teil I 1998*, p. 812

5 *Bundesgesetzblatt Teil I 2006*, p. 2407, 2416

6 Official Journal of the European Communities L 17, 20 January 1994, p. 34

II SPECIFIC CONDITIONS OF THE EUROPEAN TECHNICAL APPROVAL

1 Definition of the construction and intended use

1.1 Definition of the product

The Hilti-push-in anchor HKD of sizes M6, M8, M10, M12 and M16 is an anchor made of galvanised or stainless steel which is placed into a drilled hole and anchored by deformation-controlled expansion.

The anchor consists of an anchor body and an internal plug.

An illustration of the product and intended use is given in Annex 1.

The fixture shall be anchored with a fastening screw or threaded rod according to Annex 5.

1.2 Intended use

The anchor is intended to be used for anchorages for which requirements for safety in use in the sense of the Essential Requirements 4 of Council Directive 89/106 EEC shall be fulfilled and failure of the fixture represents an immediate risk to human life. The anchor is to be used only for multiple use for non-structural applications. The definition of multiple use according to the Member States is given in the informative Annex 1 of ETAG 001, Part 6.

The anchor may be used for anchorages with requirements related to resistance to fire.

The anchor is to be used only for anchorages subject to static or quasi-static loading in reinforced or unreinforced normal weight concrete of strength classes C20/25 at minimum and C50/60 at most according to EN 206-1:2000-12. It may be anchored in cracked or non-cracked concrete.

Anchor made of galvanised steel (Hilti HKD, HKD woL, HKD-S, HKD-E):

The anchor made of galvanised steel may only be used in structures subject to dry internal conditions.

Anchor made of stainless steel (Hilti HKD-SR, HKD-ER):

The anchor made of stainless steel may be used in structures subject to dry internal conditions and also in structures subject to external atmospheric exposure (including industrial and marine environment), or exposure in permanently damp internal conditions, if no particular aggressive conditions exist. Such particular aggressive conditions are e.g. permanent, alternating immersion in seawater or the splash zone of seawater, chloride atmosphere of indoor swimming pools or atmosphere with extreme chemical pollution (e. g. in desulphurization plants or road tunnels where de-icing materials are used).

The provisions made in this European technical approval are based on an assumed working life of the anchor of 50 years. The indications given on the working life cannot be interpreted as a guarantee given by the producer, but are to be regarded only as a means for choosing the right products in relation to the expected economically reasonable working life of the works.

2 Characteristics of product and methods of verification

2.1 Characteristics of product

The anchor corresponds to the drawings and provisions given in Annexes 1 to 3. The characteristic material values, dimensions and tolerances of the anchor not given in Annexes 1 to 3 shall correspond to the respective values laid down in the technical documentation⁷ of this European technical approval.

Regarding the requirements concerning safety in case of fire it is assumed that the anchor meets the requirements of class A1 in relation to reaction to fire in accordance with the stipulations of the Commission decision 96/603/EC, amended by 2000/605/EC.

The characteristic values for the design of anchorages are given in Annexes 7 to 9.

The characteristic anchor values for the design of the anchorages regarding resistance to fire are given in Annex 10. They are valid for use in a system that is required to provide a specific fire resistance class.

The following designations are used for different anchor versions (see Annex 1):

- HKD cold formed anchor made of galvanised steel with lip
- HKD-woL cold formed anchor made of galvanised steel without lip
- HKD-S machined anchor made of galvanised steel with lip
- HKD-SR machined anchor made of stainless steel with lip
- HKD-E machined anchor made of galvanised steel without lip
- HKD-ER machined anchor made of stainless steel without lip

Each anchor is marked with the identifying mark of the producer, the anchor identity, the thread size, the effective anchorage depth (h_{ef}) and the outer diameter of the anchor body ($\varnothing d_1$) according to Annex 1. In addition, the anchor body for anchor size M8x40 and M10x40 are marked on the top of the anchor body according to Annex 2. The anchor made of stainless steel is marked with the additional letter "R".

The anchor shall only be packaged and supplied as a complete unit.

2.2 Methods of verification

The assessment of fitness of the anchor for the intended use in relation to the requirements for safety in use in the sense of the Essential Requirements 4 has been made in accordance with the "Guideline for European technical approval of Metal Anchors for use in concrete", Part 1 "Anchors in general" and Part 6 "Anchors for multiple use for non-structural applications".

The assessment of the anchor for the intended use in relation to the requirements for resistance to fire has been made in accordance with the Technical Report TR 020 "Evaluation of anchorages in concrete concerning resistance to fire".

In addition to the specific clauses relating to dangerous substances contained in this European technical approval, there may be other requirements applicable to the products falling within its scope (e.g. transposed European legislation and national laws, regulations and administrative provisions). In order to meet the provisions of the Construction Products Directive, these requirements need also to be complied with, when and where they apply.

⁷ The technical documentation of this European technical approval is deposited at the Deutsches Institut für Bautechnik and, as far as relevant for the tasks of the approved bodies involved in the attestation of conformity procedure, is handed over to the approved bodies.

3 Evaluation and attestation of conformity and CE marking

3.1 System of attestation of conformity

According to the decision 97/161/EG of the European Commission⁸ the system 2(ii) (referred to as system 2+) of attestation of conformity applies.

This system of attestation of conformity is defined as follows:

System 2+: Declaration of conformity of the product by the manufacturer on the basis of:

- (a) Tasks for the manufacturer:
 - (1) initial type-testing of the product;
 - (2) factory production control;
 - (3) testing of samples taken at the factory in accordance with the control plan.
- (b) Tasks for the approved body:
 - (4) certification of factory production control on the basis of:
 - initial inspection of factory and of factory production control;
 - continuous surveillance, assessment and approval of factory production control.

3.2 Responsibilities

3.2.1 Tasks of the manufacturer

3.2.1.1 Factory production control

The manufacturer shall exercise permanent internal control of production. All the elements, requirements and provisions adopted by the manufacturer shall be documented in a systematic manner in the form of written policies and procedures, including records of results performed. This production control system shall insure that the product is in conformity with this European technical approval.

The manufacturer may only use initial / raw / constituent materials stated in the technical documentation of this European technical approval.

The factory production control shall be in accordance with the control plan which is part of the technical documentation of this European technical approval. The control plan is laid down in the context of the factory production control system operated by the manufacturer and deposited at Deutsches Institut für Bautechnik.⁹

The results of factory production control shall be recorded and evaluated in accordance with the provisions of the control plan.

3.2.1.2 Other tasks of manufacturer

The manufacturer shall, on the basis of a contract, involve a body which is approved for the tasks referred to in section 3.1 in the field of the anchor in order to undertake the actions laid down in section 3.3. For this purpose, the control plan referred to in sections 3.2.1.1 and 3.2.2 shall be handed over by the manufacturer to the approved body involved.

The manufacturer shall make a declaration of conformity, stating that the construction product is in conformity with the provisions of this European technical approval.

⁸ Official Journal of the European Communities L 67 of 03.02.1997

⁹ The control plan is a confidential part of the European technical approval and only handed over to the approved body involved in the procedure of attestation of conformity. See section 3.2.2.

3.2.2 Tasks of approved bodies

The approved body shall perform the

- initial inspection of factory and of factory production control,
- continuous surveillance, assessment and approval of factory production control

in accordance with the provisions laid down in the control plan relating to this European technical approval.

The approved body shall retain the essential points of its actions referred to above and state the results obtained and conclusions drawn in a written report.

The approved certification body involved by the manufacturer shall issue an EC certificate of conformity of the factory production control stating the conformity with the provisions of this European technical approval.

In cases where the provisions of the European technical approval and its control plan are no longer fulfilled the certification body shall withdraw the certificate of conformity and inform Deutsches Institut für Bautechnik without delay.

3.3 CE marking

The CE marking shall be affixed on each packing of the anchor. The letters "CE" shall be followed by the identification number of the approved certification body, where relevant, and be accompanied by the following additional information:

- the name and address of the producer (legal entity responsible for the manufacture),
- the last two digits of the year in which the CE marking was affixed,
- the number of the EC certificate for the factory production,
- the number of the European technical approval,
- the number of the guideline for European technical approval,
- use category (ETAG 001-6),
- size.

4 Assumptions under which the fitness of the product for the intended use was favourably assessed

4.1 Manufacturing

The European technical approval is issued for the product on the basis of agreed data/information, deposited with Deutsches Institut für Bautechnik, which identifies the product that has been assessed and judged. Changes to the product or production process, which could result in this deposited data/information being incorrect, should be notified to Deutsches Institut für Bautechnik before the changes are introduced. Deutsches Institut für Bautechnik will decide whether or not such changes affect the European technical approval and consequently the validity of the CE marking on the basis of the European technical approval and if so whether further assessment or alterations to the European technical approval shall be necessary.

4.2 Design of anchorages

The fitness of the anchor for the intended use is given under the following conditions:

The anchorages are designed in accordance with the "Guideline for European technical approval of Metal Anchors for Use in Concrete", Annex C, Method B, for deformation-controlled expansion anchors under the responsibility of an engineer experienced in anchorages and concrete work.

Verifiable calculation notes and drawings are prepared taking account of the loads to be anchored.

The position of the anchor is indicated on the design drawings (e. g. position of the anchor relative to reinforcement or to supports).

The minimum strength class and the minimum screwing depth of the fastening screw or threaded rod for installation of the fixture shall meet the requirements according to Annex 5. The length of the fastening screw or threaded rod shall be defined according to the available thread length, the minimum screwing depth, the thickness of fixture and tolerances of member and fixture.

The design of anchorages under fire exposure has to consider the conditions given in the Technical Report TR 020 "Evaluation of anchorages in concrete concerning resistance to fire". The relevant characteristic values are given in Annex 10. The design method covers anchors with a fire attack from one side only. If the fire attack is from more than one side, the design method may be taken only, if the edge distance of the anchor is $c \geq 300$ mm.

Local spalling is possible at fire attack. To avoid any influence of the spalling on the anchorage, the concrete member must be designed according to prEN 1992-1-2. The members shall be made of concrete with quartzite additives and have to be protected from direct moisture; and the moisture content of the concrete has to be like in dry internal conditions respectively. The anchorage depth has to be increased for wet concrete by at least 30 mm compared to the given value in the approval.

4.3 Installation of anchors

The fitness for use of the anchor can only be assumed if the anchor is installed as follows:

- Anchor installation carried out by appropriately qualified personnel and under the supervision of the person responsible for technical matters of the site.
- Use of the anchor only as supplied by the manufacturer without exchanging the components of an anchor.
- Anchor installation in accordance with the manufacturer's specifications and drawings and using the appropriate tools.
- Checks before placing the anchor to ensure that the strength class of the concrete in which the anchor is to be placed is in the range given and is not lower than that of the concrete to which the characteristic loads apply.
- Check of concrete being well compacted, e.g. without significant voids.
- Positioning of the drill holes without damaging the reinforcement.
- Drill hole by hammer drilling only.
- Cleaning of the drill hole.
- Edge distances and spacing not less than the specified values without minus tolerances.
- In case of aborted hole: new drilling at a minimum distance away of twice the depth of the aborted hole or smaller distance if the aborted drill hole is filled with high strength mortar and if under shear or oblique tension load it is not in the direction of load application.
- Anchor installation acc. to manufacturer's instructions given in Annex 6.
- Anchor expansion by impact on the cone using the setting tools given in Annex 4. The anchor is properly set if the stop of the pin reaches the anchor body and the impression of the setting tool for marking is visible as illustrated in Annex 4.
- The fastening screw or threaded rod shall correspond to the requirements given in Annex 5.
- Installation torque moments are not required for functioning of the anchor. However, the torque moments given in Annex 5 must not be exceeded.

5 Indications to the manufacturer

The manufacturer is responsible to ensure that the information on the specific conditions according to section 1 and 2 including Annexes referred to section 4.2 and 4.3 is given to those who are concerned. This information may be made by reproduction of the respective parts of the European technical approval. In addition all installation data shall be shown clearly on the package and/or on an enclosed instruction sheet, preferably using illustration(s).

The minimum data required are:

- drill bit diameter,
- thread diameter,
- minimum effective anchorage depth,
- available thread length and minimum screwing depth of the fastening screw or threaded rod,
- minimum hole depth,
- torque moment,
- information on the installation procedure, including cleaning of the hole, preferably by means of an illustration,
- reference to any special installation equipment needed,
- identification of the manufacturing batch.

All data shall be presented in a clear and explicit form.

Dipl.-Ing. Georg Feistel
Head of Division Construction Engineering
of Deutsches Institut für Bautechnik
Berlin, 22 April 2010

beglaubigt
Lange

Hilti push-in anchor HKD

multiple use for non-structural applications only

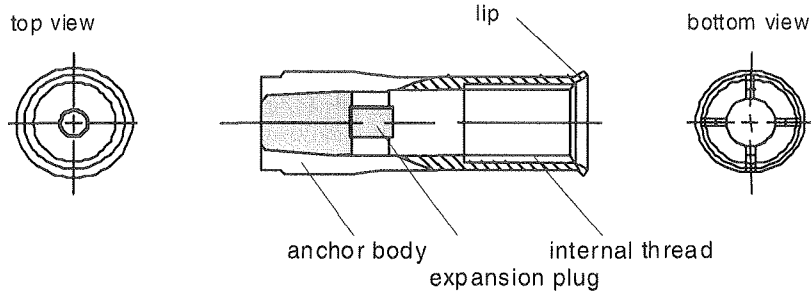

Intended use:

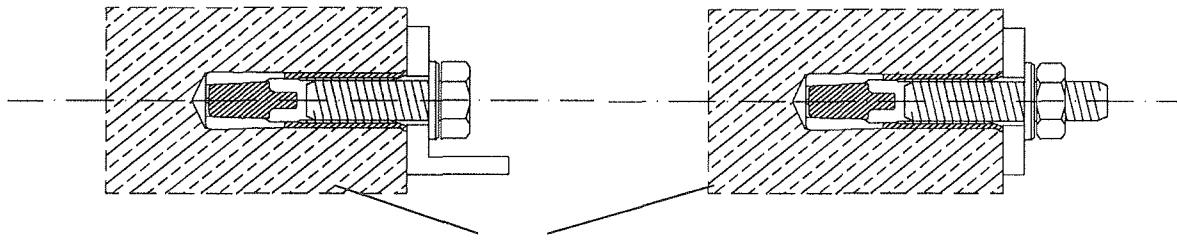

concrete C20/25 to C50/60

Marking:

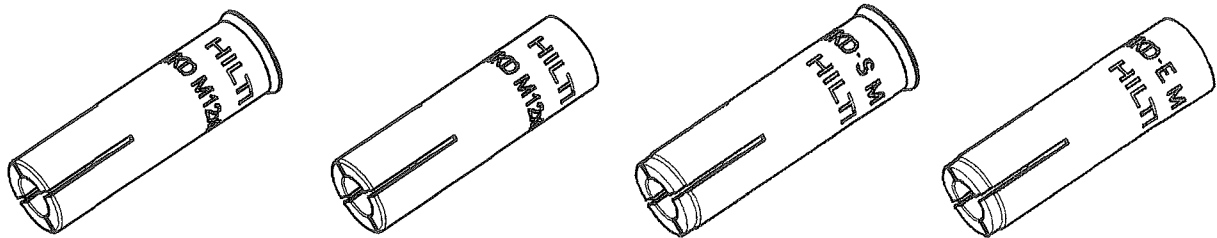

HKD

- HKD
 HKD M6 x 25
 HKD M8 x 25
 HKD M8 x 30
 HKD M8 x 40
 HKD M10 x 25
 HKD M10 x 30
 HKD M10 x 40
 HKD M12 x 25
 HKD M12 x 50
 HKD M16 x 65

HKD-woL

- HKD-woL
 HKD-woL M6 x 25
 HKD-woL M8 x 25
 HKD-woL M8 x 30
 HKD-woL M8 x 40
 HKD-woL M10 x 25
 HKD-woL M10 x 30
 HKD-woL M10 x 40
 HKD-woL M12 x 25
 HKD-woL M12 x 50
 HKD-woL M16 x 65

**HKD-S /
HKD-SR**

- HKD-S
 HKD-S M6 x 30 ø8
 HKD-S M8 x 30 ø10
 HKD-S M8 x 40 ø10
 HKD-S M10 x 30 ø12
 HKD-S M10 x 40 ø12
 HKD-S M12 x 50 ø15
- HKD-SR
 HKD-SR M6 x 30 ø8
 HKD-SR M8 x 30 ø10
 HKD-SR M10 x 40 ø12
 HKD-SR M12 x 50 ø15

**HKD-E /
HKD-ER**

- HKD-E
 HKD-E M6 x 30 ø8
 HKD-E M8 x 30 ø10
 HKD-E M8 x 40 ø10
 HKD-E M10 x 30 ø12
 HKD-E M10 x 40 ø12
 HKD-E M12 x 50 ø15
- HKD-ER
 HKD-ER M6 x 30 ø8
 HKD-ER M8 x 30 ø8
 HKD-ER M10 x 40 ø12
 HKD-ER M12 x 50 ø15

Hilti push-in anchor HKD











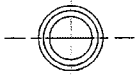

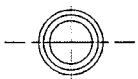

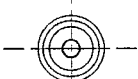

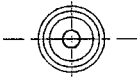

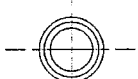
product and intended use

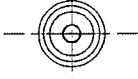
Annex 1

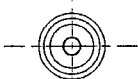
of European
 technical approval
ETA-06/0047

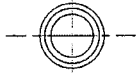
Identification after installation

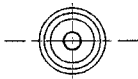
Table 1: Identification HKD and HKD-woL

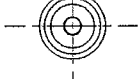
Size		setting tool	top view
HKD M6x25		HSD-G M6 x 25	
HKD M8x25		HSD-G M8 x 25/30	
HKD M8x30		HSD-G M8 x 25/30	
HKD M8x40		HSD-G M8 x 40	
HKD M10x25		HSD-G M10 x 25/30	
HKD M10x30		HSD-G M10 x 25/30	
HKD M10x40		HSD-G M10 x 40	
HKD M12x25		HSD-G M12 x 25	
HKD M12x50		HSD-G M12 x 50	
HKD M16x65		HSD-G M16 x 65	

Identification HKD-E(R) and HKD-S(R)

each anchor can be identified with setting tool after installation

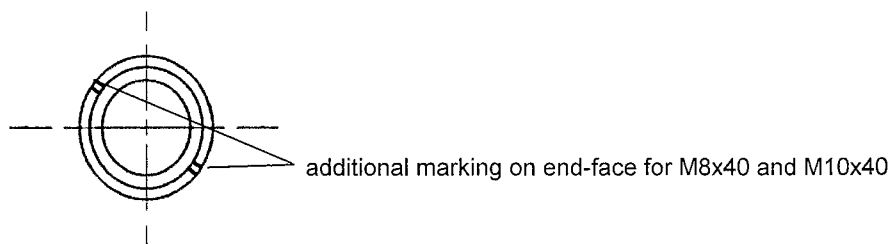

Hilti push-in anchor HKD

Identification after installation

Annex 2

of European
technical approval
ETA-06/0047

Table 2: Materials

HKD; HKD-woL		
designation		material
1	anchor body	cold formed steel – galvanised to $\geq 5 \mu\text{m}$, EN 10084 or EN 10111
2	expansion plug	cold formed steel, EN 10084 or EN 10111
HKD-S; HKD-E		
designation		material
1	anchor body	steel Fe/Zn5 (galvanised to $\geq 5 \mu\text{m}$), EN 10087, EN 10277-3
2	expansion plug	steel 1.0213, EN 10263-2 or steel 1.0204, DIN 17111
HKD-SR; HKD-ER		
designation		material
1	anchor body	stainless steel, 1.4401, 1.4404 or 1.4571 EN 10088-3
2	expansion plug	

① anchor body

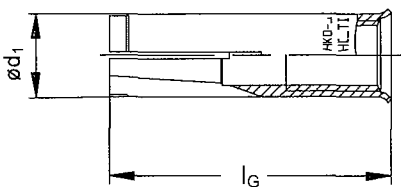

② expansion plug

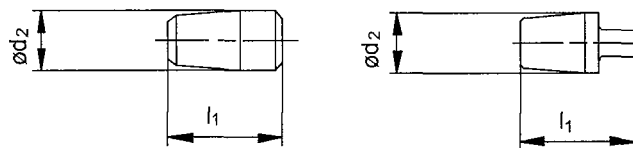

Table 3: Dimensions

anchor size	l_G [mm]	$\varnothing d_1$ [mm]	$\varnothing d_2$ [mm]	l_1 [mm]
M6x25	25	7,9	5,1	10
M6x30	30	8	5	15
M8x25	25	9,95	6,35	7
M8x30	30	9,95	6,5	12
M8x40	40	9,95	6,35	16
M10x25	25	11,90	8,1	7
M10x30	30	11,80	8,2	12
M10x40	40	11,95	8,2	16
M12x25	25	14,90	9,7	7,2
M12x50	50	14,90	10,3	20
M16x65	60	19,75	13,8	29

Hilti push-in anchor HKD

**anchor materials and
anchor dimensions**

Annex 3

of European
technical approval
ETA-06/0047

Manual setting tool HSD-G M.. x h_{ef}

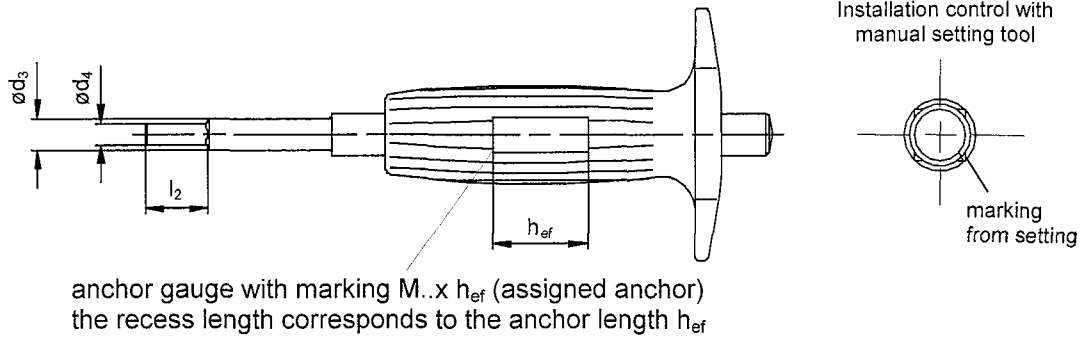

Machine setting tool HSD-M M.. x h_{ef}

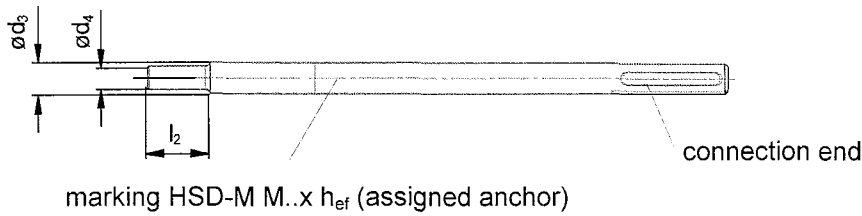

Machine setting tool HSD-TE CX M.. x h_{ef}

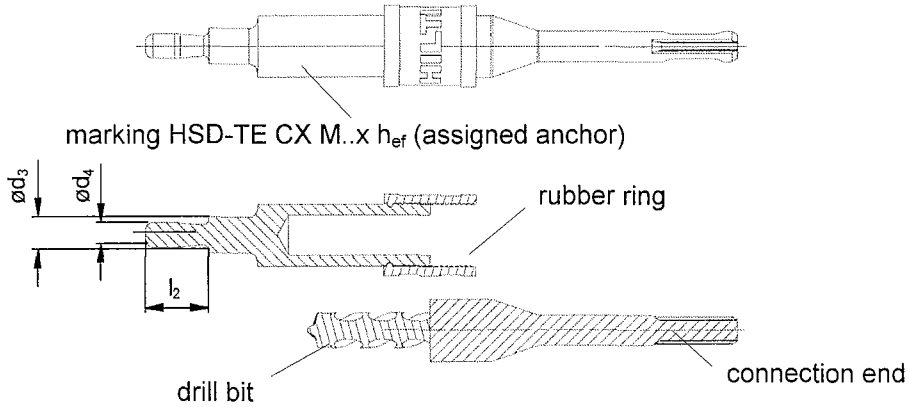

Table 4: Dimensions of the setting tools

setting tool HSD / HSG	$\varnothing d_3$ [mm]	$\varnothing d_4$ [mm]	l_2 [mm]
M6x25	7,5	5	15
M6x30	7,5	5	15
M8x25	9,5	6,5	18
M8x30	9,5	6,5	18
M8x40	9,5	6,5	28
M10x25	11,5	8	18
M10x30	11,5	8	18
M10x40	11,5	8	24
M12x25	14,5	10,2	18
M12x50	14,5	10,2	30
M16x65	18,0	13,5	36

Hilti push-in anchor HKD

setting tools

Annex 4

of European
technical approval
ETA-06/0047

Installation data

Fastening screw or threaded rod:

For anchor made of galvanised steel (HKD, HKD-woL, HKD-E and HKD-S) the property class is 4.6 / 5.6 / 5.8 or 8.8 according to EN ISO 898-1 to use.

For anchor made of stainless steel (HKD-ER and HKD-SR) the minimum property class is A4-70 according EN ISO 3506 to use.

Minimum screw depth $l_{s,min}$: The length of the screw shall be determined depending on thickness of fixture t_{fix} , admissible tolerances and available thread length $l_{s,max}$ as well as minimum screw depth $l_{s,min}$.

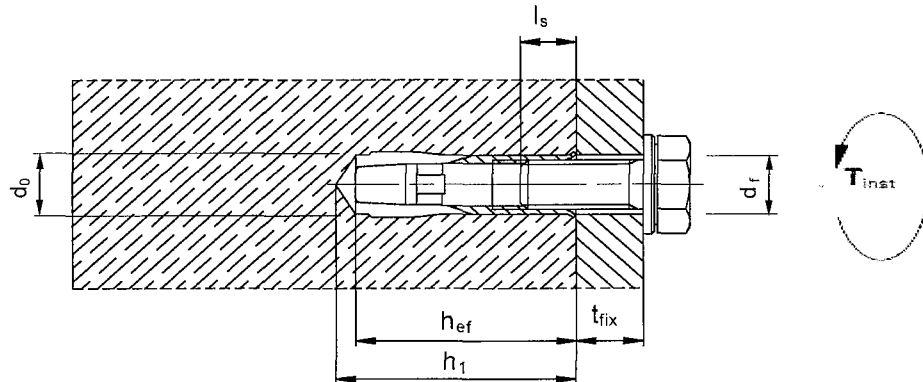

Table 5: Installation data

anchor size	drill hole diameter	thread diameter	drill hole depth	effective anchorage depth	maximum screwing depth	minimum screwing depth	maximum tightening torque	Clearance hole diameter
	d_0 [mm]	d [mm]	h_1 [mm]	h_{ef} [mm]	$l_{s,max}$ [mm]	$l_{s,min}$ [mm]	T_{inst} [Nm]	d_f [mm]
M6x25	8	6	27	25	12,0	6	≤ 4	7
M6x30	8	6	32	30	12,5	6	≤ 4	7
M8x25 ¹⁾	10	8	27	25	11,5	8	≤ 8	9
M8x30	10	8	33	30	14,5	8	≤ 8	9
M8x40	10	8	43	40	17,5	8	≤ 8	9
M10x25 ¹⁾	12	10	27	25	12,0	10	≤ 15	12
M10x30 ¹⁾	12	10	33	30	12,7	10	≤ 15	12
M10x40	12	10	43	40	18,0	10	≤ 15	12
M12x25 ¹⁾	15	12	27	25	12,0	12	≤ 35	14
M12x50	15	12	54	50	23,5	12	≤ 35	14
M16x65	20	16	70	65	30,5	16	≤ 60	18

¹⁾ with anchor size M8x25, M10x25, M10x30 and M12x25 **only** threaded rod are to be used

Hilti push-in anchor HKD

Installation data

Annex 5

of European
technical approval
ETA-06/0047

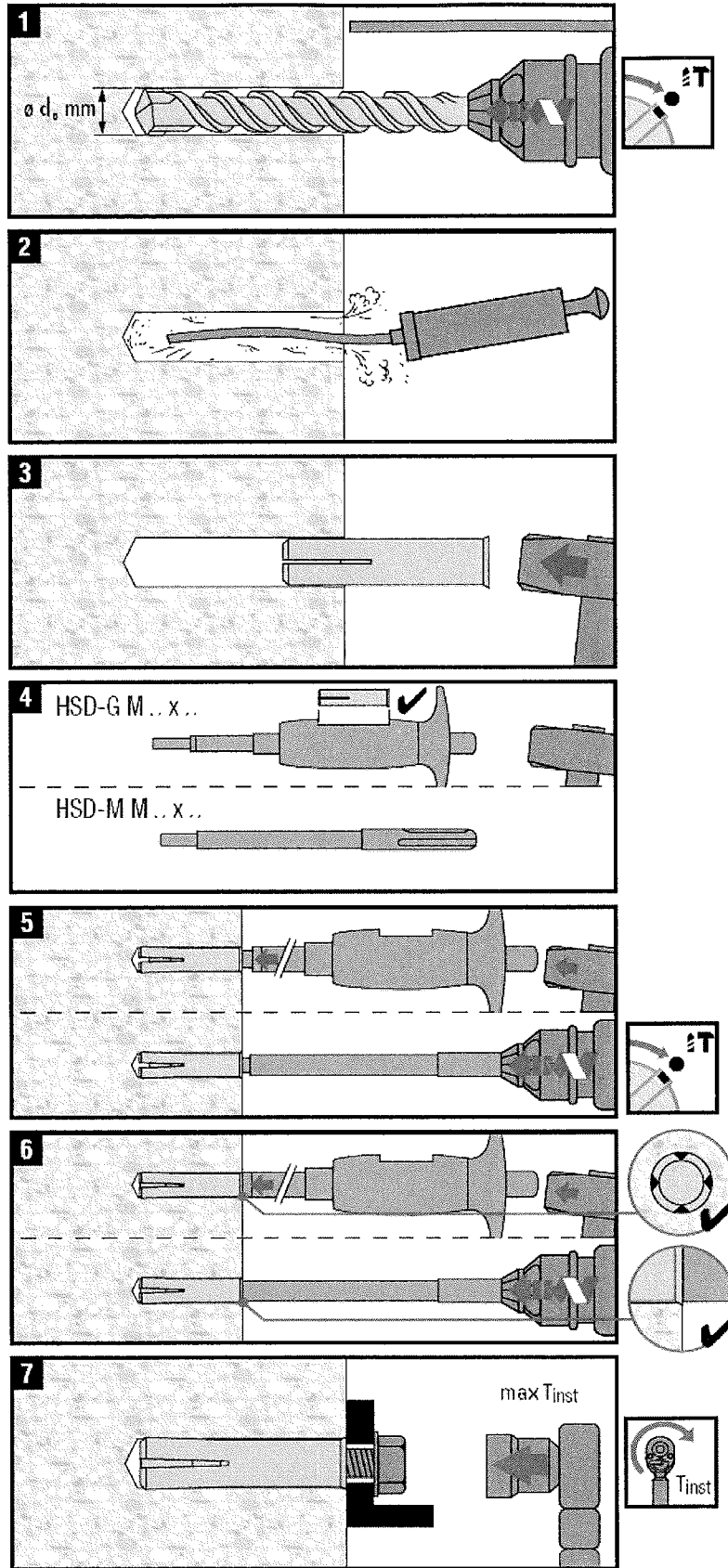

Hilti push-in anchor HKD

Instruction for use

Annex 6

of European
technical approval
ETA-06/0047

Table 7: Minimum spacing and minimum edge distance, minimum thickness of concrete member

HKD-S(R), HKD-E(R)		M6x30 M8x30 M10x30	M8x40 M10x40	M12x50
Minimum spacing and minimum edge distance				
Minimum thickness of concrete member	h_{min} [mm]	100	100	100
Minimum spacing	s_{min} [mm]	60	80	125
Minimum edge distance	c_{min} [mm]	105	140	175
Minimum thickness of concrete member				
Minimum thickness of concrete member	h_{min} [mm]	80	80	-
Minimum spacing	s_{min} [mm]	200	200	-
Minimum edge distance	c_{min} [mm]	150	150	-

Table 8: Minimum spacing and minimum edge distance, minimum thickness of concrete member

HKD, HKD-woL		M6x25 M8x25 M10x25 M12x25	M8x30 M10x30	M8x40 M10x40	M12x50	M16x65
Minimum spacing and minimum edge distance						
Minimum thickness of concrete member	h_{min} [mm]	100	100	100	100	120
Minimum spacing	s_{min} [mm]	80	60	80	125	130
	for $c \geq$ [mm]	140	105	140	175	230
Minimum edge distance	c_{min} [mm]	100	80	140	175	230
	for $s \geq$ [mm]	150	120	80	125	130
Minimum thickness of concrete member						
Minimum thickness of concrete member	h_{min} [mm]	80	80	80	-	-
Minimum spacing	s_{min} [mm]	200	200	200	-	-
Minimum edge distance	c_{min} [mm]	150	150	150	-	-

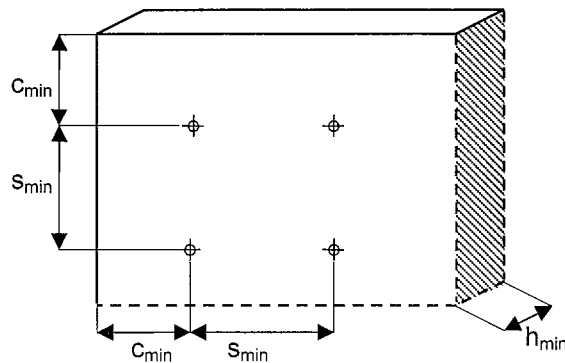

Hilti push-in anchor HKD

**Minimum thickness of concrete member
minimum spacing and edge distance**

Annex 7

of European
technical approval
ETA-06/0047

Table 9: Design method B - Characteristic values

galvanised steel: HKD-S, HKD-E		S(R) M6x30 E(R) M6x30	S(R) M8x30 E(R) M8x30	S M10x30	S M8x40 E M8x40	S(R) M10x40 E(R) M10x40	S(R) M12x50 E(R) M12x50		
All load directions									
Characteristic resistance in C20/25 to C50/60	F_{Rk}^0	[kN]	3	3	4	5	6		
Partial safety factor	γ_M	¹⁾	1,5 ²⁾						
characteristic spacing	s_{cr}	[mm]	90	90	90	120	150		
characteristic edge distance	c_{cr}	[mm]	45	45	45	60	75		
Shear load with lever arm									
Characteristic resistance	$M_{Rk,s}^0$	³⁾ steel 4.6	[Nm]	6	15	30	15	30	52
Partial safety factor	γ_{Ms}		1,67						
Characteristic resistance	$M_{Rk,s}^0$	³⁾ steel 5.6	[Nm]	8	19	37	19	37	65
Partial safety factor	γ_{Ms}		1,67						
Characteristic resistance	$M_{Rk,s}^0$	³⁾ steel 5.8	[Nm]	8	19	37	19	37	65
Partial safety factor	γ_{Ms}		1,25						
Characteristic resistance	$M_{Rk,s}^0$	³⁾ steel 8.8	[Nm]	12	30	60	30	60	105
Partial safety factor	γ_{Ms}		1,25						
Characteristic resistance	$M_{Rk,s}^0$	³⁾ steel A4-70	[Nm]	11	26	-	-	52	92
Partial safety factor	γ_{Ms}		1,56						

- 1) In absence of other national regulations.
- 2) The installation factor $\gamma_2 = 1,0$ is included.
- 3) Characteristic bending moment $M_{Rk,s}^0$ for equation (5.5) in ETAG 001, Annex C.

The anchor is to be used only for multiple use for non-structural applications, the definition of multiple use according to the member states is given in the informative Annex 1 of ETAG 001, part 6.

Hilti push-in anchor HKD	Annex 8 of European technical approval ETA-06/0047
Design method B Characteristic values HKD-S(R) und HKD-E(R)	

Table 10: Design method B - Characteristic values

galvanised steel: HKD, HKD-woL	M6x25	M8x25	M8x30	M8x40	M10x25	M10x30	M10x40	M12x25	M12x50	M16x65		
All load directions												
Characteristic resistance in C20/25 to C50/60	F_{Rk}^0	[kN]	2	3	5	5	4	5	7,5	4	9	16
Partial safety factor	γ_M	¹⁾	1,5 ²⁾		1,8 ³⁾	1,5 ²⁾	1,8 ³⁾	1,5 ²⁾				
characteristic spacing	s_{cr}	[mm]	80	80	90	120	80	90	120	80	150	200
characteristic edge distance	c_{cr}	[mm]	40	40	45	60	40	45	60	40	75	100
Shear load with lever arm												
Characteristic resistance	$M_{Rk,s}^0$ ⁴⁾	[Nm]	6	15		30		52		133		
Partial safety factor	γ_{Ms}		1,67									
Characteristic resistance	$M_{Rk,s}^0$ ⁴⁾	[Nm]	8	19		37		65		166		
Partial safety factor	γ_{Ms}		1,67									
Characteristic resistance	$M_{Rk,s}^0$ ⁴⁾	[Nm]	8	19		37		65		166		
Partial safety factor	γ_{Ms}		1,25									
Characteristic resistance	$M_{Rk,s}^0$ ⁴⁾	[Nm]	12	30		60		105		266		
Partial safety factor	γ_{Ms}		1,25									

- 1) In absence of other national regulations.
- 2) The installation factor $\gamma_2 = 1,0$ is included.
- 3) The installation factor $\gamma_2 = 1,2$ is included.
- 4) Characteristic bending moment $M_{Rk,s}^0$ for equation (5.5) in ETAG 001, Annex C.

The anchor is to be used only for multiple use for non-structural applications, the definition of multiple use according to the member states is given in the informative Annex 1 of ETAG 001, part 6.

Hilti push-in anchor HKD	Annex 9 of European technical approval ETA-06/0047
Design method B Characteristic values HKD und HKD-woL	

Table 11: Characteristic resistance under fire exposure in concrete C20/25 to C50/60 in any load direction

For galvanised fastening screw or threaded rod with property class 4.6 to 8.8 according to Annex 5

Fire resistance class	HKD, HKD-woL		M6x25	M8x25	M8x30	M8x40	M10x25	M10x30	M10x40	M12x25	M12x50	M16x65
R 30	Characteristic resistance	$F_{Rk,fi}^0$ ¹⁾ [kN]	0,5	0,6	0,9	1,3	0,6	0,9	1,8	0,6	2,3	4,0
R 60	Characteristic resistance	$F_{Rk,fi}^0$ ¹⁾ [kN]	0,4	0,6	0,9	1,3	0,6	0,9	1,8	0,6	2,3	4,0
R 90	Characteristic resistance	$F_{Rk,fi}^0$ ¹⁾ [kN]	0,3	0,6	0,9	1,3	0,6	0,9	1,8	0,6	2,3	4,0
R 120	Characteristic resistance	$F_{Rk,fi}^0$ ¹⁾ [kN]	0,2	0,5	0,7	0,7	0,5	0,7	1,5	0,5	1,8	3,2
R 30 to R 120	Spacing	$s_{cr,fi}$ [mm]	160	160	120	160	120	120	160	160	200	260
	Edge distance	$c_{cr,fi}$ [mm]	140	140	105	140	105	105	140	105	175	230

In case of fire attack from more than one side, the minimum edge distance shall be ≥ 300 mm. The anchorage depth has to be increased for wet concrete by at least 30 mm compared to the given value.

¹⁾ In absence of other national regulations the partial safety factor for resistance under fire exposure $\gamma_{m,fi} = 1,0$ is recommended.

Table 12: Characteristic resistance under fire exposure in concrete C20/25 to C50/60 in any load direction

For minimum property class of fastening screw or threaded rod the remarks according to Annex 5

Fire resistance class	HKD-SR, HKD-ER (stainless steel)		M6x30	M8x30	M10x40	M12x50
R 30	Characteristic resistance	$F_{Rk,fi}^0$ ¹⁾ [kN]	0,5	0,9	1,8	2,3
R 60	Characteristic resistance	$F_{Rk,fi}^0$ ¹⁾ [kN]	0,5	0,9	1,8	2,3
R 90	Characteristic resistance	$F_{Rk,fi}^0$ ¹⁾ [kN]	0,4	0,9	1,8	2,3
R 120	Characteristic resistance	$F_{Rk,fi}^0$ ¹⁾ [kN]	0,3	0,7	1,5	1,8
R 30 to R 120	Spacing	$s_{cr,fi}$ [mm]	120	120	160	200
	Edge distance	$c_{cr,fi}$ [mm]	105	105	140	175

In case of fire attack from more than one side, the minimum edge distance shall be ≥ 300 mm. The anchorage depth has to be increased for wet concrete by at least 30 mm compared to the given value.

¹⁾ In absence of other national regulations the partial safety factor for resistance under fire exposure $\gamma_{m,fi} = 1,0$ is recommended.

Hilti push-in anchor HKD

Characteristic resistance under fire exposure

Annex 10

of European technical approval
ETA-06/0047