

Deutsches Institut für Bautechnik

Anstalt des öffentlichen Rechts

Kolonnenstr. 30 L
10829 Berlin
Germany

Tel.: +49(0)30 787 30 0
Fax: +49(0)30 787 30 320
E-mail: dibt@dibt.de
Internet: www.dibt.de

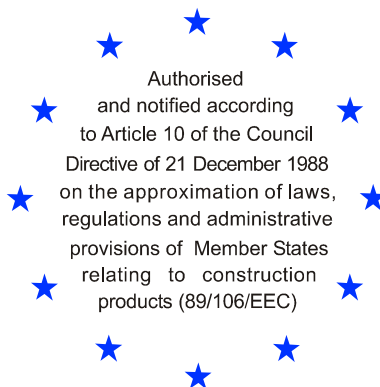

DIBt

Mitglied der EOTA
Member of EOTA

European Technical Approval ETA-07/0219

English translation prepared by DIBt - Original version in German language

Handelsbezeichnung <i>Trade name</i>	Hilti Rahmendübel HRD <i>Hilti frame anchor HRD</i>
Zulassungsinhaber <i>Holder of approval</i>	Hilti Aktiengesellschaft Business Unit Anchors 9494 Schaan FÜRSTENTUM LIECHTENSTEIN
Zulassungsgegenstand und Verwendungszweck <i>Generic type and use of construction product</i>	Kunststoffdübel als Mehrfachbefestigung von nichttragenden Systemen zur Verankerung im Beton und Mauerwerk <i>Plastic anchor for multiple use in concrete and masonry for non-structural applications</i>
Geltungsdauer: <i>Validity:</i>	vom <i>from</i> 12 August 2010 bis <i>to</i> 17 September 2012
Herstellwerk <i>Manufacturing plant</i>	Hilti, Werk 9

Diese Zulassung umfasst
This Approval contains

24 Seiten einschließlich 13 Anhänge
24 pages including 13 annexes

Diese Zulassung ersetzt
This Approval replaces

ETA-07/0219 mit Geltungsdauer vom 17.09.2007 bis 17.09.2012
ETA-07/0219 with validity from 17.09.2007 to 17.09.2012



Europäische Organisation für Technische Zulassungen
European Organisation for Technical Approvals

I LEGAL BASES AND GENERAL CONDITIONS

- 1 This European technical approval is issued by Deutsches Institut für Bautechnik in accordance with:
 - Council Directive 89/106/EEC of 21 December 1988 on the approximation of laws, regulations and administrative provisions of Member States relating to construction products¹, modified by Council Directive 93/68/EEC² and Regulation (EC) N° 1882/2003 of the European Parliament and of the Council³;
 - Gesetz über das In-Verkehr-Bringen von und den freien Warenverkehr mit Bauprodukten zur Umsetzung der Richtlinie 89/106/EWG des Rates vom 21. Dezember 1988 zur Angleichung der Rechts- und Verwaltungsvorschriften der Mitgliedstaaten über Bauprodukte und anderer Rechtsakte der Europäischen Gemeinschaften (Bauproduktengesetz - BauPG) vom 28. April 1998⁴, as amended by law of 31 October 2006⁵;
 - Common Procedural Rules for Requesting, Preparing and the Granting of European technical approvals set out in the Annex to Commission Decision 94/23/EC⁶;
 - Guideline for European technical approval of "Plastic Anchors for Multiple Use in Concrete and Masonry for Non-structural Applications – Part 1: General", ETAG 020-01.
- 2 Deutsches Institut für Bautechnik is authorized to check whether the provisions of this European technical approval are met. Checking may take place in the manufacturing plant. Nevertheless, the responsibility for the conformity of the products to the European technical approval and for their fitness for the intended use remains with the holder of the European technical approval.
- 3 This European technical approval is not to be transferred to manufacturers or agents of manufacturers other than those indicated on page 1, or manufacturing plants other than those indicated on page 1 of this European technical approval.
- 4 This European technical approval may be withdrawn by Deutsches Institut für Bautechnik, in particular pursuant to information by the Commission according to Article 5(1) of Council Directive 89/106/EEC.
- 5 Reproduction of this European technical approval including transmission by electronic means shall be in full. However, partial reproduction can be made with the written consent of Deutsches Institut für Bautechnik. In this case partial reproduction has to be designated as such. Texts and drawings of advertising brochures shall not contradict or misuse the European technical approval.
- 6 The European technical approval is issued by the approval body in its official language. This version corresponds fully to the version circulated within EOTA. Translations into other languages have to be designated as such.

1 Official Journal of the European Communities L 40, 11 February 1989, p. 12

2 Official Journal of the European Communities L 220, 30 August 1993, p. 1

3 Official Journal of the European Union L 284, 31 October 2003, p. 25

4 *Bundesgesetzblatt Teil I 1998*, p. 812

5 *Bundesgesetzblatt Teil I 2006*, p.2407, 2416

6 Official Journal of the European Communities L 17, 20 January 1994, p. 34

II SPECIFIC CONDITIONS OF THE EUROPEAN TECHNICAL APPROVAL

1 Definition of product and intended use

1.1 Definition of the construction product

The Hilti frame anchor HRD in the range HRD 8 and HRD 10 is a plastic anchor consisting of a plastic sleeve made of polyamide and an accompanying specific screw of galvanised steel or stainless steel.

The plastic sleeve is expanded by screwing in the specific screw which presses the sleeve against the wall of the drilled hole.

The installed anchor is shown in Annex 1.

1.2 Intended use

The anchor is intended to be used for anchorages for which requirements for safety in use in the sense of the Essential Requirement 4 of Council Directive 89/106/EEC shall be fulfilled and failure of the fixture represents an immediate risk to human life.

The anchor is to be used only for multiple fixing for non-structural applications in concrete and masonry. The base material shall consist of reinforced or unreinforced normal weight concrete of strength class C12/15 at minimum and C50/60 at maximum according to EN 206-1:2000-12 and of masonry walls according to Annex 9 to 12. The anchor may be used in cracked and non-cracked concrete. The mortar strength class of the masonry has to be M2,5 according to EN 998-2:2003 at minimum.

The anchor HRD 10 may also be used in masonry walls made of (non-cracked) autoclaved aerated concrete blocks (AAC) according to Annex 13.

The anchor HRD 10 may also be used in concrete with requirements related to resistance to fire according 4.2.2.

Specific screws of electro galvanised steel and stainless steel (1.4301 and 1.4567):

The specific screw made of galvanised steel or stainless steel (1.4301 and 1.4567) may only be used in structures subject to dry internal conditions.

These screws may also be used in structures subject to external atmospheric exposure, if the area of the head of the screw is protected against moisture and driving rain after mounting of the fixing unit in this way, that intrusion of moisture into the anchor shaft is prevented. Therefore there shall be an external cladding or a ventilated rainscreen mounted in front of the head of the screw and the head of the screw itself shall be coated with a soft plastic, permanently elastic bitumen-oil-combination coating (e. g. undercoating or body cavity protection for cars).

Specific screws of stainless steel (1.4362, 1.4401, 1.4404 and 1.4571):

The specific screw made of stainless steel (1.4362, 1.4401, 1.4404 and 1.4571) may be used in structures subject to dry internal conditions and also in structures subject to external atmospheric exposure (including industrial and marine environment), or exposure in permanently damp internal conditions, if no particular aggressive conditions exist. Such particular aggressive conditions are e. g. permanent, alternating immersion in seawater or the splash zone of seawater, chloride atmosphere of indoor swimming pools or atmosphere with extreme chemical pollution (e. g. in desulphurization plants or road tunnels where de-icing materials are used).

The anchor may be used in the following temperature range:

Temperature range: -40 °C to +80 °C (max long term temperature +50 °C and
max short term temperature +80 °C)

The provisions made in this European Technical Approval are based on an assumed working life of the anchor of 50 years. The indications given on the working life cannot be interpreted as a guarantee given by the producer, but are to be regarded only as a means for choosing the right products in relation to the expected economically reasonable working life of the works.

2 Characteristics of the product and methods of verification

2.1 Characteristics of the product

The anchor corresponds to the drawings and information given in Annex 2 and 3. The characteristic material values, dimensions and tolerances of the anchor not given in these Annexes shall correspond to the respective values laid down in the technical documentation⁷ of this European Technical Approval.

The characteristic values for the design of the anchorages are given in Annex 7 and 9 to 13. Each anchor is to be marked with the identifying mark, the type, the diameter and the length of the anchor according to Annex 2.

The minimum embedment depth shall be marked.

The anchor shall only be packaged and supplied as a complete unit.

2.2 Methods of verification

The assessment of the fitness of the anchor for the intended use in relation to the requirements for safety in use in the sense of the Essential Requirement 4 has been made in compliance with the Guideline for European Technical Approval of "Plastic Anchors for Multiple Use in Concrete and Masonry for Non-structural Applications", ETAG 020,

- Part 1: "General",
- Part 2: "Plastic Anchors for Use in Normal Weight Concrete",
- Part 3: "Plastic Anchors for Use in Solid Masonry Materials",
- Part 4: "Plastic Anchors for Use in Hollow or Perforated Masonry" and
- Part 5: "Plastic Anchors for Use in Autoclaved Aerated Concrete (AAC)",

based on the use categories a, b, c (HRD 8) and a, b, c, d (HRD 10).

In addition to the specific clauses relating to dangerous substances contained in this European Technical Approval, there may be other requirements applicable to the products falling within its scope (e. g. transposed European legislation and national laws, regulations and administrative provisions). In order to meet the provisions of the Construction Products Directive, these requirements need also to be complied with, when and where they apply.

⁷ The technical documentation of this European Technical Approval is deposited at the Deutsches Institut für Bautechnik and, as far as relevant for the tasks of the approved bodies involved in the attestation of conformity procedure, is handed over to the approved bodies.

3 Evaluation and attestation of conformity and CE marking

3.1 System of attestation of conformity

According to the decision 97/463/EG of the European Commission⁸ the system 2(ii) (referred to as system 2+) of attestation of conformity applies.

This system of attestation of conformity is defined as follows.

System 2+: Declaration of conformity of the product by the manufacturer on the basis of:

(a) Tasks for the manufacturer:

- (1) initial type-testing of the product;
- (2) factory production control;
- (3) testing of samples taken at the factory in accordance with a prescribed test plan.

(b) Tasks for the approved body:

- (4) certification of factory production control on the basis of:
 - initial inspection of factory and of factory production control;
 - continuous surveillance, assessment and approval of factory production control.

3.2 Responsibilities

3.2.1 Tasks of the manufacturer

3.2.1.1 Factory production control

The manufacturer shall exercise permanent internal control of production. All the elements, requirements and provisions adopted by the manufacturer shall be documented in a systematic manner in the form of written policies and procedures, including records of results performed. This production control system shall insure that the product is in conformity with this European Technical Approval.

The manufacturer may only use raw materials stated in the technical documentation of this European Technical Approval.

The factory production control shall be in accordance with the control plan which is part of the technical documentation of this European Technical Approval. The control plan is laid down in the context of the factory production control system operated by the manufacturer and deposited at Deutsches Institut für Bautechnik.⁹

The results of factory production control shall be recorded and evaluated in accordance with the provisions of the control plan.

3.2.1.2 Other tasks of manufacturer

The manufacturer shall, on the basis of a contract, involve a body which is approved for the tasks referred to in section 3.1 in the field of anchors in order to undertake the actions laid down in section 3.2.2. For this purpose, the control plan referred to in sections 3.2.1.1 and 3.2.2 shall be handed over by the manufacturer to the approved body involved.

The manufacturer shall make a declaration of conformity, stating that the construction product is in conformity with the provisions of this European Technical Approval.

3.2.2 Tasks of approved bodies

The approved body shall perform the

- initial inspection of factory and of factory production control,
 - continuous surveillance, assessment and approval of factory production control,
- in accordance with the provisions laid down in the control plan.

⁸ Official Journal of the European Communities L 198 of 25.07.1997.

⁹ The control plan is a confidential part of the documentation of the European Technical Approval, but not published together with the ETA and only handed over to the approved body involved in the procedure of attestation of conformity.
See section 3.2.2.

The approved body shall retain the essential points of its actions referred to above and state the results obtained and conclusions drawn in a written report.

The approved certification body involved by the manufacturer shall issue an EC certificate of conformity of the factory production control stating the conformity with the factory production control of this European Technical Approval.

In cases where the provisions of the European Technical Approval and its control plan are no longer fulfilled the certification body shall withdraw the certificate of conformity and inform Deutsches Institut für Bautechnik without delay.

3.3 CE marking

The CE marking shall be affixed on each packaging of the anchor. The letters "CE" shall be followed by the identification number of the approved certification body, where relevant, and be accompanied by the following additional information:

- the name and address of the producer (legal entity responsible for the manufacturer),
- the last two digits of the year in which the CE marking was affixed,
- the number of the EC certificate for the factory production control,
- the number of the European Technical Approval,
- the number of the guideline for European Technical Approval
- use categories a, b, c (HRD 8) and a, b, c, d (HRD 10).

4 Assumptions under which the fitness of the product for the intended use was favourably assessed

4.1 Manufacturing

The European Technical Approval is issued for the product on the basis of agreed data/information, deposited with Deutsches Institut für Bautechnik, which identifies the product that has been assessed and judged. Changes to the product or production process, which could result in this deposited data/information being incorrect, should be notified to Deutsches Institut für Bautechnik before the changes are introduced. Deutsches Institut für Bautechnik will decide whether or not such changes affect the ETA and consequently the validity of the CE marking on the basis of the ETA and if so whether further assessment or alterations to the ETA shall be necessary.

4.2 Design of anchorages

4.2.1 General

Fitness for the intended use of the anchor is given under the following conditions:

- The design of anchorages is carried out in compliance with ETAG 020, Guideline for European Technical Approval of "Plastic Anchors for Multiple Use in Concrete and Masonry for Non-structural Applications", Annex C under the responsibility of an engineer experienced in anchorages. This design method applies to plastic anchors subject to static or quasi-static actions in tension, shear or combined tension and shear or bending; it is not applicable to plastic anchors loaded in compression or subject to fatigue, impact, or seismic actions.
- Verifiable calculation notes and drawings shall be prepared taking account of the loads to be anchored, the nature and strength of the base materials and the dimensions of the anchorage members as well as of the relevant tolerances.

- The anchor is to be used only for multiple fixing for non-structural applications. Therefore the design of the fixture may specify the number n_1 of fixing points to fasten the fixture and the number n_2 of anchors per fixing point. Furthermore by specifying the design value of actions N_{Sd} on a fixing point to a value $\leq n_3$ (kN) up to which the strength and stiffness of the fixture are fulfilled and the load transfer in the case of excessive slip or failure of one anchor need not to be taken into account in the design of the fixture.

The following default values for n_1 , n_2 and n_3 may be taken:

$$n_1 \geq 4; \quad n_2 \geq 1 \quad \text{and} \quad n_3 \leq 4,5 \text{ kN} \quad \text{or} \\ n_1 \geq 3; \quad n_2 \geq 1 \quad \text{and} \quad n_3 \leq 3,0 \text{ kN}.$$

Shear loads acting on an anchor may be assumed to act without lever arm if both of the following conditions are fulfilled:

- The fixture shall be made of metal and in the area of the anchorage be fixed directly to the base material either without an intermediate layer or with a levelling layer of mortar with a thickness ≤ 3 mm.
- The fixture shall be in contact with the anchor over its entire thickness. (Therefore the diameter of clearance hole in the fixture d_f has to be equal or smaller than the values given in Annex 4, Table 3.)

If these two conditions are not fulfilled the lever arm is calculated according to ETAG 020, Annex C. The characteristic bending moment is given in Annex 7, Table 7.

4.2.2 Resistance in concrete (use category "a")

The characteristic values of resistance of the anchor for use in concrete are given in Annex 7, Table 8. The design method is valid for cracked and non-cracked concrete.

According to the Technical Report TR 020 "Evaluation of anchorages in concrete concerning resistance to fire" it can be assumed that for fastening of facade systems the load bearing behaviour of the HRD 10 with $h_{nom} \geq 50$ mm has a sufficient resistance to fire at least 90 minutes (R90) if the admissible load $[F_{Rk} / (\gamma_M \cdot \gamma_F)]$ is $\leq 0,8$ kN (no permanent centric tension load).

4.2.3 Resistance in solid masonry (use category "b")

The characteristic values of resistance of the anchor for use in solid masonry are given in Annex 7, Table 7 and Annex 9, Table 11. These values are independent of the load direction (tension, shear or combined tension and shear) and the mode of failure.

The characteristic resistances given in Annex 9, Table 11 for use in solid masonry are valid for the base material and the bricks according this table or larger brick sizes and larger compressive strength of the masonry unit.

If smaller brick sizes are present on the construction site or if the mortar strength is smaller than the required value, the characteristic resistance of the anchor may be determined by job site tests according to 4.4.

4.2.4 Resistance in hollow or perforated masonry (use category "c")

The characteristic resistances given in Annex 10 to 12 for use in hollow or perforated masonry are only valid for the bricks and blocks according this table regarding base material, size of the units, compressive strength and configuration of the voids.

These values are independent of the load direction (tension, shear or combined tension and shear) and the mode of failure and are valid for $h_{nom} = 50$ mm (HRD 8) and $h_{nom,1} = 50$ mm or $h_{nom,2} = 70$ mm (HRD 10) only.

The influence of larger embedment depths [$h_{nom} > 50$ mm (HRD 8) and $h_{nom,1} > 50$ mm or $h_{nom,2} > 70$ mm (HRD 10)] and/or different bricks and blocks (according Annex 10 to 12 regarding base material, size of the units, compressive strength and configuration of the voids) has to be detected by job site tests according to 4.4.

4.2.5 Resistance in (non-cracked) autoclaved aerated concrete blocks (AAC, use category "d")

The characteristic values of resistance of the anchor for use in masonry made of (non-cracked) autoclaved aerated concrete blocks (AAC) are given in Annex 13, Table 14. These values are independent of the load direction (tension, shear or combined tension and shear) and the mode of failure.

The anchor shall not be installed and used in water saturated aerated concrete.

4.2.6 Specific conditions for the design method in solid masonry, hollow or perforated masonry and AAC blocks

The mortar strength class of the masonry has to be M2,5 according to EN 998-2:2003 at minimum.

The characteristic resistance F_{Rk} for a single plastic anchor may also be taken for a group of two or four plastic anchors with a spacing equal or larger than the minimum spacing s_{min} .

The distance between single plastic anchors or a group of anchors should be $s \geq 250$ mm.

If the vertical joints of the wall are designed not to be filled with mortar then the design resistance N_{Rd} has to be limited to 2,0 kN to ensure that a pull-out of one brick out of the wall will be prevented. This limitation can be omitted if interlocking units are used for the wall or when the joints are designed to be filled with mortar.

If the joints of the masonry are not visible the characteristic resistance F_{Rk} has to be reduced with the factor $\alpha_j = 0,5$.

If the joints of the masonry are visible (e.g. unplastered wall) following has to be taken into account:

- The characteristic resistance F_{Rk} may be used only, if the wall is designed such that the joints are to be filled with mortar.
- If the wall is designed such that the joints are not to be filled with mortar then the characteristic resistance F_{Rk} may be used only, if the minimum edge distance c_{min} to the vertical joints is observed. If this minimum edge distance c_{min} can not be observed then the characteristic resistance F_{Rk} has to be reduced with the factor $\alpha_j = 0,5$.

4.2.7 Characteristic values, spacing and dimensions of anchorage member

The minimum spacing and dimensions of anchorage member according to Annex 6, Table 6, Annex 8, Table 10 and Annex 13, Table 13 shall be observed depending on the base material.

4.2.8 Displacement behaviour

The displacements under tension and shear loading in concrete, masonry and AAC are given in Annex 8, Table 9.

4.3 Installation of anchor

The fitness for use of the anchor can only be assumed if the following conditions of installation are met:

- Anchor installation carried out by appropriately qualified personnel under the supervision of the person responsible for technical matters on site.
- Use of the anchor only as supplied by the manufacturer without exchanging any component of the anchor.
- Anchor installation in accordance with the manufacturer's specifications and drawings using the tools indicated in this European Technical Approval.

- Checks before placing the anchor, to ensure that the characteristic values of the base material in which the anchor is to be placed, is identical with the values, which the characteristic loads apply for.
- Observation of the drill method according Annex 10 to 12 (Drill holes in some hollow or perforated masonry may only be drilled using the rotary drill. Other drilling methods may also be used if job-site tests according to 4.4 evaluate the influence of hammer or impact drilling.).
- Placing drill holes without damaging the reinforcement.
- Observation of the different overall plastic anchor embedment depths (compare 4.2.4):
HRD 8 $h_{nom} \geq 50$ mm [for concrete, solid and hollow or perforated masonry]
HRD 10: $h_{nom,1} \geq 50$ mm [for concrete, solid and hollow or perforated masonry]
 $h_{nom,2} \geq 70$ mm [for concrete, solid, hollow or perforated masonry and AAC]
 $h_{nom,3} \geq 90$ mm [for AAC only]
- The anchor shall not be installed and used in water saturated aerated concrete.
- Holes to be cleaned of drilling dust.
- In case of aborted hole: New drilling at a minimum distance away of twice the depth of the aborted hole or smaller distance if the aborted drill hole is filled with high strength mortar.
- The plastic sleeve is inserted through the fixture by slight hammer blows and the special screw is screwed in until the head of the screw touches the sleeve. The anchor is correct mounted, if there is no turn-through of the plastic sleeve in the drill hole and if slightly move on turning of the screw is impossible after the complete turn-in of the screw.
- Temperature during installation of the anchor ≥ -10 °C (plastic sleeve and base material).

4.4 Job site tests according to ETAG 020, Annex B

4.4.1 General

In the absence of national requirements the characteristic resistance of the plastic anchor may be determined by job site tests, if the plastic anchor has already characteristic values given in Annex 9 to 12 for the same base material as it is present on the construction works.

Furthermore job site tests for use in (different) solid masonry are possible only if the plastic anchor has already characteristic values given in Annex 9 for use in solid masonry.

Job site tests for use in (different) hollow or perforated masonry are possible only if the plastic anchor has already characteristic values given in Annex 10 to 12 for use in hollow or perforated masonry.

Job site tests are also possible, if another drill method is been used as it is given in Annex 10 to 12.

The characteristic resistance to be applied to a plastic anchor should be determined by means of at least 15 pull-out tests carried out on the construction work with a centric tension load acting on the plastic anchor. These tests may also performed in a laboratory under equivalent conditions as used on construction work

Execution and evaluation of the tests as well as issue of the test report and determination of the characteristic resistance should be supervised by the person responsible for execution of works on site and be carried out by a competent person.

Number and position of the plastic anchors to be tested should be adapted to the relevant special conditions of the construction work in question and, for example, in the case of blind and larger areas be increased such that a reliable information about the characteristic resistance of the plastic anchor embedded in the base material in question can be derived. The tests should take account of the unfavourable conditions of practical execution.

4.4.2 Assembly

The plastic anchor to be tested shall be installed (e. g. preparation of drill hole, drilling tool to be used, drill bit, type of drilling hammer or rotation, thickness of fixture) and as far as spacing and edge distances are concerned be distributed in the same way as foreseen for the intended use.

Depending on the drilling tool hard metal hammer drill bits or hard metal percussion drill bits, respectively, according to ISO 5468 should be used. New drill bits should be used for one test series or drill bits with $d_{\text{cut,m}} = 8,3 \text{ mm} < d_{\text{cut}} \leq 8,45 \text{ mm} = d_{\text{cut,max}}$ (HRD 8) or $d_{\text{cut,m}} = 10,25 \text{ mm} < d_{\text{cut}} \leq 10,45 \text{ mm} = d_{\text{cut,max}}$ (HRD 10).

4.4.3 Execution of test

The test rig used for the pull-out tests shall provide a continuous slow increase of the load, controlled by a calibrated load cell. The load shall apply perpendicular to the surface of the base material and shall be transmitted to the anchor via a hinge. The reaction forces shall be transmitted into the base material such that possible breakout of the masonry is not restricted. This condition is considered as fulfilled, if the support reaction forces are transmitted either in adjacent masonry units or at a distance of at least 150 mm from the plastic anchors. The load shall be increased continuously in a way that the ultimate load is reached after about 1 minute. The load is measured when the ultimate load (N_1) is achieved.

If no pull-out failure occurs, other test methods are needed, e.g. proof-loading.

4.4.4 Test report

The test report shall include all information necessary to assess the resistance of the tested anchor. It shall be given to the person responsible for the design of the fastening and shall be included in the construction dossier.

The minimum data required are:

- Name of product
- Construction site, owner of building; date and location of the tests, air temperature
- Date and place of tests
- Test rig
- Type of structure to be fixed
- Masonry (type of brick, strength class, all dimensions of bricks, mortar group if possible); visual assessment of masonry (flush joints, joint clearance, regularity)
- Plastic anchor and special screw
- value of the cutting diameter of hard metal hammer-drill bits, measured before and after drilling if no new drill bits are used
- Results of tests including the indication of value N_1 ; mode of failure
- Tests carried out or supervised by ...; signature

4.4.5 Evaluation of test results

The characteristic resistance F_{Rk1} is derived from the measured values N_1 as follows

$$F_{Rk1} = 0,5 \cdot N_1$$

The characteristic resistance F_{Rk1} has to be equal or smaller than the characteristic resistance F_{Rk} which is given in the ETA for similar masonry (bricks or blocks)

$$N_1 = \text{the mean value of the five smallest measured values at ultimate load}$$

In absence of national regulations the partial safety factors for the resistance of the plastic anchor may be taken as $\gamma_M = 2,5$ for use in masonry.

5 Indications to the manufacturer

5.1 Responsibility of the manufacturer

It is in the responsibility of the manufacturer to ensure that the information on the specific conditions according to 1 and 2 including Annexes referred to 4 is given to those who are concerned. This information may be made by reproduction of the respective parts of the European Technical Approval. In addition, all installation data shall be shown clearly on the packaging and/or on an enclosed instruction sheet, preferably using illustrations.

The minimum data required are:

- base material for the intended use,
- ambient temperature of the base material during installation of the anchor,
- drill bit diameter,
- overall anchor embedment depth in the base material,
- minimum hole depth,
- information on the installation procedure,
- identification of the manufacturing batch.

All data shall be presented in a clear and explicit form.

5.2 Packaging, transport and storage

The anchor shall only be packaged and supplied as a complete unit.

The anchor shall be stored under normal climatic conditions in its original light-proof packaging. Before installation, it shall not be extremely dried nor frozen.

Georg Feistel
Abteilungsleiter
Berlin, 12. August 2010

beglaubigt:
Scheller

Hilti frame anchor HRD

Intended use with different embedment depth in concrete, solid brick, hollow brick and autoclaved aerated concrete

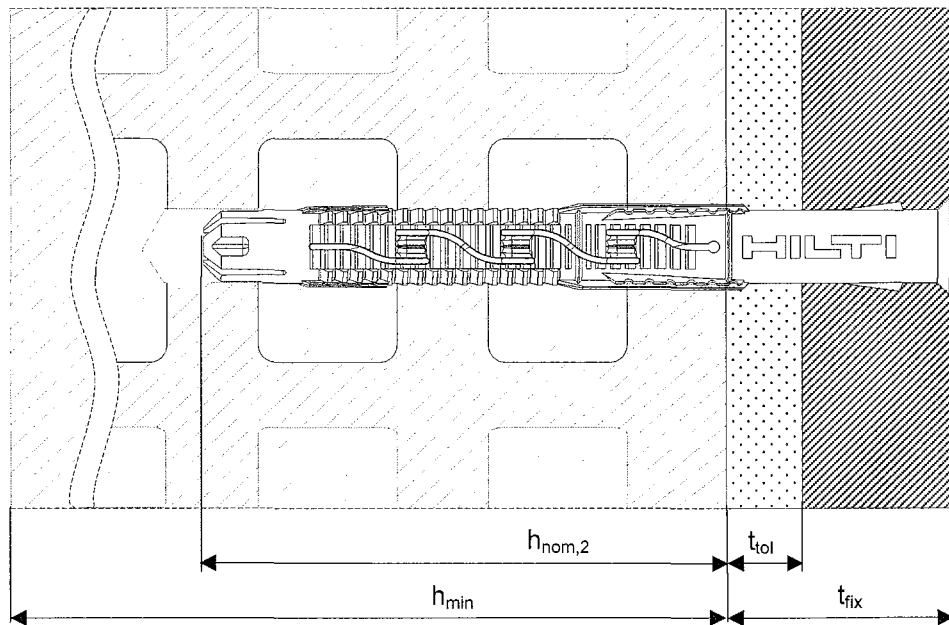
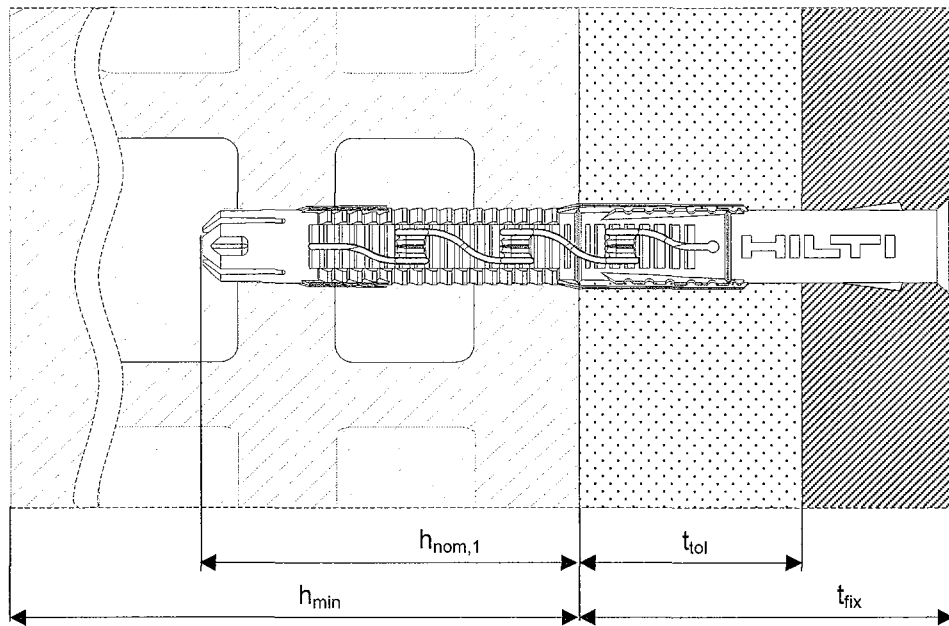

- h_{nom} = overall plastic anchor embedment depth in the base material
- h_{min} = minimum thickness of base material
- t_{fix} = thickness of fixture
- t_{tol} = thickness of non-load-bearing layer

Hilti frame anchor HRD

Annex 1

Intended use

of European
Technical Approval
ETA-07/0219

HRD 8

Anchor sleeve

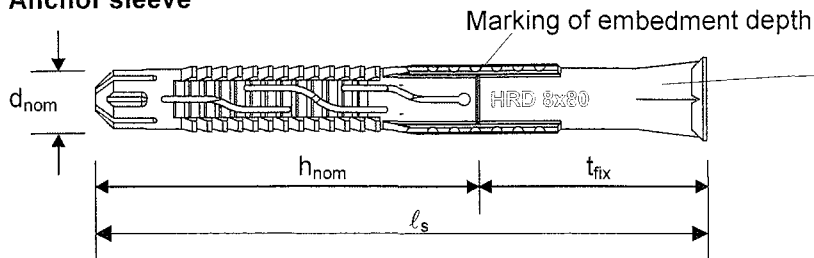

Marking:
 Producer, Type, size
 e.g.

 HRD 8x80

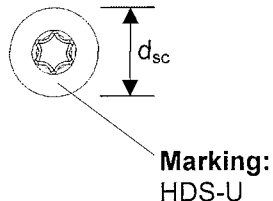
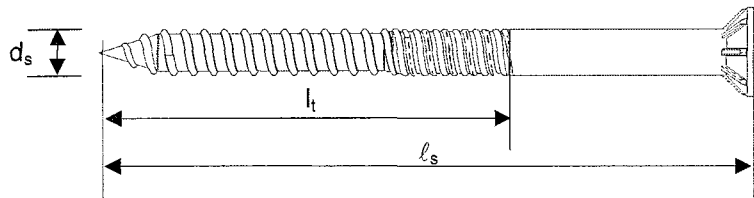
Special screw

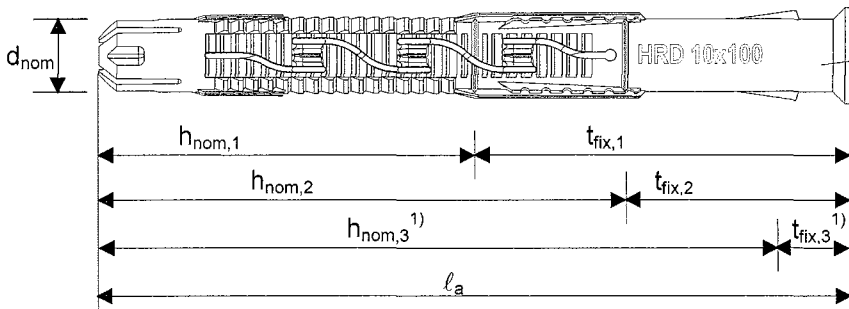

HRD 10

Anchor sleeve



Marking:
 Producer, Type, Size
 e.g.

 HRD 10x100

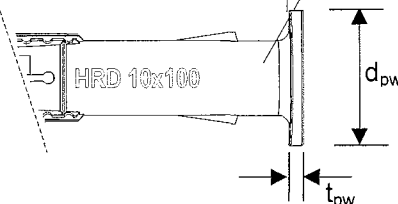
¹⁾ for AAC only

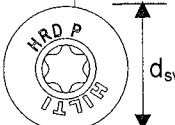
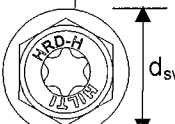
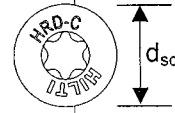
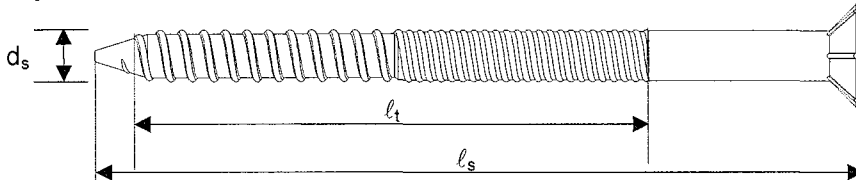

Marking:
 "HRD"-Type
 e.g. HRD-C

Special screw



Hilti frame anchor HRD

Annex 2

Anchor types and dimensions

of European
 Technical Approval
ETA-07/0219

Product naming

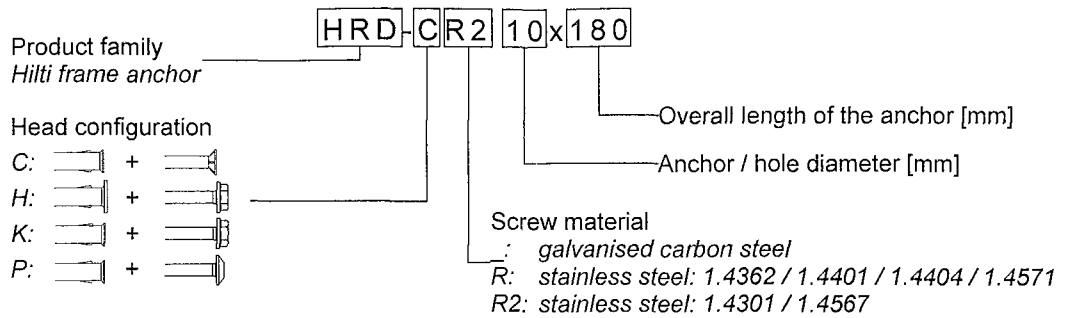

Table 1: Anchor types and dimensions [mm]

Anchor type		HRD 8	HRD 10	
Plastic sleeve	Sleeve diameter d_{nom} [mm]	8	10	
	Length of sleeve	min l_a [mm]	60	60
		max l_a [mm]	140	310
	Diameter of plastic washer d_{pw} [mm]	-	17,5	
	Thickness of plastic washer t_{pw} [mm]	-	2	
Special screw	Screw diameter d_s [mm]	6	7	
	Length of screw l_s [mm]	$l_a + 5$	$l_a + 5$	
	Length of thread l_t [mm]	53	70	
	Head diameter	Countersunk screw d_{sc} [mm]	11	14
		Hexhead screw d_{sw} [mm]	-	17,5

Table 2: Materials

Element	Material	
	HRD 8	HRD 10
Plastic sleeve	Polyamide, colour red	
Special screw	Steel, electro galvanised $\geq 5 \mu m$, blue passivated, coated $f_{yk} = 480 \text{ N/mm}^2, f_{uk} = 600 \text{ N/mm}^2$	
	Stainless steel: 1.4301 / 1.4567 (e.g. A2 acc. ISO 3506), coated $f_{yk} = 450 \text{ N/mm}^2, f_{uk} = 580 \text{ N/mm}^2$ $f_{yk} = 480 \text{ N/mm}^2, f_{uk} = 600 \text{ N/mm}^2$	
	Stainless steel: 1.4362 / 1.4401 / 1.4404 / 1.4571 (e.g. A4 acc. ISO 3506), coated $f_{yk} = 450 \text{ N/mm}^2, f_{uk} = 580 \text{ N/mm}^2$ $f_{yk} = 480 \text{ N/mm}^2, f_{uk} = 600 \text{ N/mm}^2$	

Hilti frame anchor HRD	Annex 3 of European Technical Approval ETA-07/0219
Anchor types and dimensions Materials	

Table 3: Installation parameters

Anchor type		HRD 8	HRD 10
Drill hole diameter	d_0 [mm]	8	10
Cutting diameter of drill bit	$d_{cut} \leq$ [mm]	8,45	10,45
Depth of drilled hole to deepest point	$h_{1,1} \geq$ [mm]	60	60
	$h_{1,2} \geq$ [mm]	-	80
	$h_{1,3} \geq$ [mm]	-	100 ¹⁾
Overall plastic anchor embedment depth in base material	$h_{nom,1} \geq$ [mm]	50	50
	$h_{nom,2} \geq$ [mm]	-	70
	$h_{nom,3} \geq$ [mm]	-	90 ¹⁾
Diameter of clearance hole in the fixture	Countersunk screw $d_f \leq$ [mm]	8,5	11
	Hexhead screw $d_f \leq$ [mm]	-	12
Installation temperature	[°C]	-10 - +40	
Service temperature	[°C]	-40 - +80	
	maximum long term [°C]	+50	
	maximum short term [°C]	+80	

1) for AAC only

Table 4: Relation of h_{nom} , l_a and t_{fix} for use in concrete and masonry

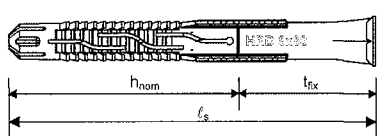
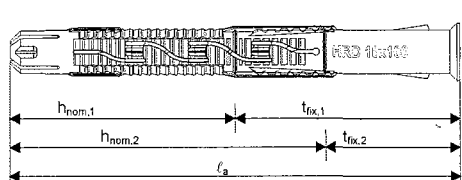
Anchor type		HRD 8 x l_a	HRD 10 x l_a		
Use category "a, b, c"		$h_{nom} \geq 50 \text{ mm}^{1)}$	$h_{nom,1} \geq 50 \text{ mm}^{1)}$	$h_{nom,2} \geq 70 \text{ mm}^{2)}$	
		l_a	t_{fix}	$t_{fix,1}$	$t_{fix,2}$
		[mm]	[mm]	[mm]	[mm]
HRD 8 	60	≤ 10	≤ 10	---	
	80	≤ 30	≤ 30	≤ 10	
	100	≤ 50	≤ 50	≤ 30	
	120	≤ 70	≤ 70	≤ 50	
HRD 10 	140	≤ 90	≤ 90	≤ 70	
	160	---	≤ 110	≤ 90	
	180	---	≤ 130	≤ 110	
	200	---	≤ 150	≤ 130	
	230	---	≤ 180	≤ 160	
	270	---	≤ 220	≤ 200	
	310	---	≤ 260	≤ 240	

1) In hollow masonry (bricks and blocks) the influence of $h_{nom} > 50 \text{ mm}$ or $h_{nom,1} > 50 \text{ mm}$ has to be checked by job-site testing according chapter 4.2.4 and 4.4.

2) In hollow masonry (bricks and blocks) the influence of $h_{nom,2} > 70 \text{ mm}$ has to be checked by job-site testing according chapter 4.2.4 and 4.4.

Hilti frame anchor HRD

Installation parameters
Relations for t_{fix} in concrete and masonry

Annex 4

of European
Technical Approval
ETA-07/0219

Table 5: Relation of h_{nom} , l_a and t_{fix} for use in autoclaved aerated concrete (AAC)

Anchor type		HRD 10 x l_a	
Use category "d"		$h_{nom,2}$ ≥ 70 mm	$h_{nom,3}$ ≥ 90 mm
HRD 10		$t_{fix,2}$	$t_{fix,3}$
l_a [mm]		[mm]	[mm]
60		---	---
80		≤ 10	---
100		≤ 30	≤ 10
120		≤ 50	≤ 30
140		≤ 70	≤ 50
160		≤ 90	≤ 70
180		≤ 110	≤ 90
200		≤ 130	≤ 110
230		≤ 150	≤ 130
270		≤ 180	≤ 160
310		≤ 220	≤ 200

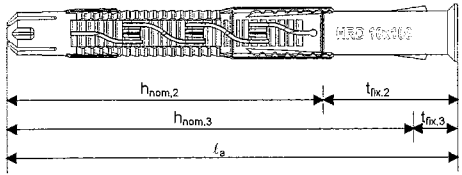

Setting instruction

Setting instruction diagrams:

- 1:** Drilling a hole in AAC. Dimensions: $L+10\text{ mm}$ (total length), d_0 (hole diameter). Drill bits: 8mm (HRD 8), 10mm (HRD 10).
- 1.1:** Selection of anchor based on concrete strength class (C12, C16, C20, C24) and embedment depth. Shows the HRD 10 anchor.
- 2:** Inserting the anchor into the hole.
- 3:** Driving the anchor into the hole with a hammer. Shows correct and incorrect driving angles.
- 4:** Driving the anchor into the hole with a power drill. Shows correct and incorrect driving angles. Labels: T30 (HRD 8), T40 (HRD 10).
- 5:** Visual inspection of the installed anchor. Shows a correct installation with an eye icon and exclamation mark.
- A.6:** Correct installation of an anchor in a corner. Shows a warning triangle, a checkmark, and a correct installation.
- B.6:** Incorrect installation of an anchor in a corner. Shows a warning triangle, a prohibition sign, and an incorrect installation.

Hilti frame anchor HRD

Annex 5

Relations for t_{fix} in AAC
Setting instruction

of European
Technical Approval
ETA-07/0219

Table 6: Minimum thickness of member, edge distance and anchor spacing in concrete

		HRD 8	HRD 10	
Overall plastic anchor embedment depth in the base material	$h_{nom} \geq$ [mm]	50	50	70
Minimum thickness of member	h_{min} [mm]	100	100	120
Minimum allowable spacing	\geq C16/20 s_{min} [mm]	100	50 if $c \geq 100$ ¹⁾	
	C12/15 s_{min} [mm]	140	70 if $c \geq 140$ ¹⁾	
Minimum allowable edge distance	\geq C16/20 c_{min} [mm]	50	50 if $s \geq 150$ ¹⁾	
	C12/15 c_{min} [mm]	70	70 if $s \geq 210$ ¹⁾	
Characteristic edge distance	\geq C16/20 $c_{cr,N}$ [mm]	100	100	
	C12/15 $c_{cr,N}$ [mm]	140	140	
Characteristic spacing ²⁾	\geq C16/20 $s_{cr,N}$ [mm]	62	80	125
	C12/15 $s_{cr,N}$ [mm]	68	90	135

1) Linear interpolation allowed

2) Spacing at which a fixing point that consists of more than 1 anchor can be calculated with the characteristic resistance $N_{Rk,p}$ of each anchor ($N_{Rk,p}$ see Annex 7, Table 8).

Scheme of distances and spacing

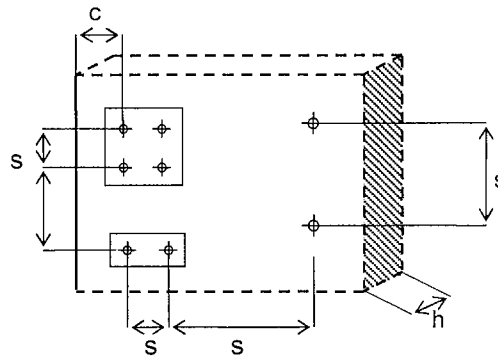

Hilti frame anchor HRD

Minimum thickness, edge distance and spacing in concrete

Annex 6

of European
Technical Approval
ETA-07/0219

Table 7: Characteristic bending moment of screw for use in concrete, masonry and AAC

		HRD 8		HRD 10	
Screw material		galvanised steel	stainless steel	galvanised steel	stainless steel
Characteristic bending resistance	$M_{Rk,s}$ [Nm]	11,1	10,8	21,3	
Partial safety factor	γ_{Ms} ¹⁾	1,25	1,28	1,25	1,25

1) In absence of other national regulations

Table 8: Characteristic resistance for use in concrete (use category "a")

		HRD 8		HRD 10	
Failure of expansion element (steel failure of special screw)					
		galvanised steel	stainless steel	galvanised steel	stainless steel
Characteristic tension resistance	$N_{Rk,s}$ [kN]	10,9	10,5	17,5	
Partial safety factor	γ_{Ms} ¹⁾	1,50	1,54	1,50	1,50
Characteristic shear resistance	$V_{Rk,s}$ [kN]	6,9	6,6	10,6	
Partial safety factor	γ_{Ms} ¹⁾	1,25	1,28	1,25	1,25
Pull-out failure (plastic sleeve)					
Embedment depth	$h_{nom} \geq$ [mm]	50		50	70
Characteristic resistance	\geq C16/20 $N_{Rk,p}$ [kN]	3,0		4,5	8,5
	C12/15 $N_{Rk,p}$ [kN]	2,0		3,0	6,0
Partial safety factor	γ_{Mc} ¹⁾	1,8			
Concrete cone failure and concrete edge failure for single anchor and anchor group					
Tension load ²⁾					
$N_{Rk,c} = 7,2 \cdot \sqrt{f_{ck,cube}} \cdot h_{ef}^{1,5} \cdot \frac{c}{c_{cr,N}} = N_{Rk,p} \cdot \frac{c}{c_{cr,N}} \quad \text{with} \quad h_{ef}^{1,5} = \frac{N_{Rk,p}}{7,2 \cdot \sqrt{f_{ck,cube}}}$					
Shear load ²⁾					
$V_{Rk,c} = 0,45 \cdot \sqrt{d_{nom}} \cdot (h_{nom}/d_{nom})^{0,2} \cdot \sqrt{f_{ck,cube}} \cdot c_1^{1,5} \cdot \left(\frac{c_2}{1,5 c_1}\right)^{0,5} \cdot \left(\frac{h}{1,5 c_1}\right)^{0,5} \quad \text{with} \quad \left(\frac{c_2}{1,5 c_1}\right)^{0,5} \leq 1$ $\left(\frac{h}{1,5 c_1}\right)^{0,5} \leq 1$					
c_1 edge distance closest to the edge in loading direction c_2 edge distance perpendicular to direction 1 $f_{ck,cube}$ nominal characteristic concrete compression strength (based on cubes), values for C50/60 most					
Partial safety factor		γ_{Mc} ¹⁾		1,8	

1) In absence of other national regulations

2) The design method according to ETAG 020, Annex C is to be used

Hilti frame anchor HRD

Characteristic bending moment,
characteristic resistance in concrete (use category "a")

Annex 7

of European
Technical Approval
ETA-07/0219

Table 9: Displacements under tension and shear loading in concrete, masonry and ACC

		HRD 8	HRD 10	
Embedment depth	$h_{nom} \geq$ [mm]	50	50	70
Displacement under tension load	F [kN]	1,2	1,8	3,3
	δ_{NO} [mm]	0,3	0,5	0,9
	$\delta_{N\infty}$ [mm]	0,6	1,0	1,8
Displacement under shear load	F [kN]	1,2	1,8	3,3
	δ_{VO} [mm]	1,0	1,5	2,8
	$\delta_{V\infty}$ [mm]	1,5	2,3	4,2

Table 10: Minimum thickness of member, edge distance and anchor spacing in masonry

		HRD 8	HRD 10
Minimum thickness of member	h_{min} [mm]	110	See Table 12.1–12.3
Minimum allowable edge distance	c_{min} [mm]	100 (60 ¹⁾)	100
Minimum allowable spacing (single anchor)	s_{min} [mm]	250	250
Minimum allowable spacing (anchor group)	perpendicular to free edge	s_{min1} [mm]	200 (120 ¹⁾)
	parallel to free edge	s_{min2} [mm]	400 (240 ¹⁾)

¹⁾ only for brick "Doppio Uni" and "Mattone"

Scheme of distances and spacing

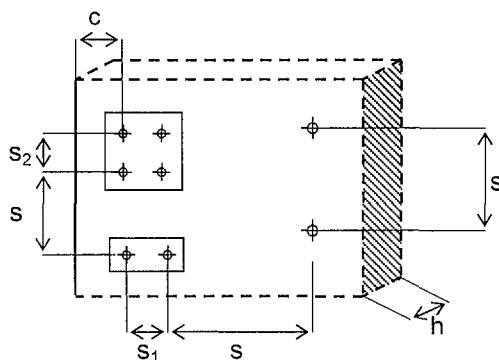

Hilti frame anchor HRD

Displacements in concrete, masonry and AAC
minimum thickness, spacing and edge distance in masonry

Annex 8

of European
Technical Approval
ETA-07/0219

Table 11: Characteristic resistance for use in solid masonry (use category "b")¹⁾

		HRD 8	HRD 10	
		F_{Rk} ⁵⁾ [kN]	F_{Rk} ⁵⁾ [kN]	
		$h_{nom} \geq 50$	$h_{nom,1} \geq 50$	$h_{nom,2} \geq 70$
Clay brick Mz 2,0-2DF DIN V 105-100 / EN 771-1 Manufacturer: Augsburger Ziegel LxWxH [mm]: 240x115x113 h_{min} [mm]: 115	$f_b \geq 20$ ⁶⁾	1,5	3,0	4)
			4,5 ³⁾	
Sand-lime solid brick KS 2,0-2DF Manufacturer: Werk Derching DIN V 106-100 / EN 771-2 LxWxH [mm]: 240x115x113 h_{min} [mm]: 115	$f_b \geq 10$ ⁶⁾	1,2	2,0	4)
			3,0 ³⁾	
Sand-lime solid brick KS 2,0-2DF Manufacturer: Werk Derching DIN V 106-100 / EN 771-2 LxWxH [mm]: 240x115x113 h_{min} [mm]: 115	$f_b \geq 20$ ⁶⁾	2,5	3,0	4)
			4,5 ³⁾	
Lightweight concrete solid block Vbl / V Manufacturer: KLB DIN V 18152 / EN 771-3 LxWxH [mm]: 240x300x115 h_{min} [mm]: 240	$f_b \geq 10$ ⁶⁾	2,0	2,0	4)
			3,0 ³⁾	
Lightweight concrete solid block Vbl / V Manufacturer: KLB DIN V 18152 / EN 771-3 LxWxH [mm]: 240x300x115 h_{min} [mm]: 240	$f_b \geq 20$ ⁶⁾	-	3,5	4)
			6,0 ³⁾	
Lightweight concrete solid block Vbl / V Manufacturer: KLB DIN V 18152 / EN 771-3 LxWxH [mm]: 240x300x115 h_{min} [mm]: 240	$f_b \geq 10$ ⁶⁾	-	2,5	4)
			4,5 ³⁾	
	$f_b \geq 2$ ⁶⁾	0,5	-	-
Partial safety factor		γ_{Mm} ²⁾ [-]	2,5	

1) Drilling method: hammer drill

2) In absence of other national regulations

3) Valid for edge distance $c \geq 150$ mm, intermediate values can be interpolated

4) Data can be determined by job-site testing, data for $h_{nom} = 50$ mm can be applied

5) Characteristic resistance for tension, shear or combined tension and shear loading.

The characteristic resistance is valid for single plastic anchor or for a group of two or four plastic anchors with spacing equal or larger than the minimum spacing s_{min} according to Table 10. The specific conditions for the design method have to be considered according to chapter 4.2.6 of the ETA.

6) Mean compressive strength [N/mm²]

Hilti frame anchor HRD

Characteristic resistance in solid masonry (use category "b")

Annex 9

of European
Technical Approval
ETA-07/0219

Table 12.1: Characteristic resistance for use in hollow masonry (use category "c") for HRD 8

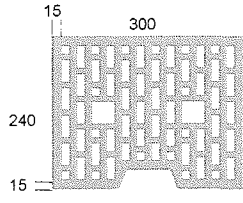
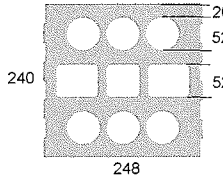
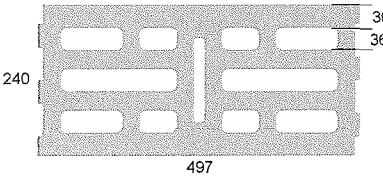
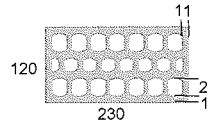
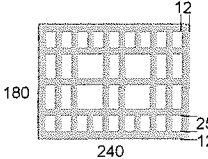
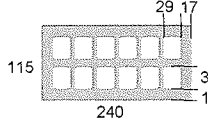
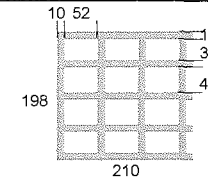
Base material	Brick dimensions	Compressive strength-class	F_{Rk} ⁴⁾
Specifications	Drilling method	[N/mm ²]	[kN]
			$h_{nom}=50$ ¹⁾
Vertically perforated clay brick HLz B 12/1,2 DIN V 105-100 / EN 771-1 LxWxH [mm]: 300x240x248 h_{min} [mm]: 240		≥ 12	0,5
	rotary drilling only		
Vertically perforated sand-lime brick KSL 12/1,4 DIN V 106 / EN 771-2 LxWxH [mm]: 240x248x248 h_{min} [mm]: 240		≥ 12	0,75
	hammer drilling		
Lightweight concrete hollow block Hbl 2/0,8 DIN V 18151-100 / EN 771-3 LxWxH [mm]: 497x240x248 h_{min} [mm]: 240		≥ 2	0,3
	hammer drilling		
Ital. Hollow brick Doppio Uni EN 771-1 LxWxH [mm]: 230x120x100 h_{min} [mm]: 120		$f_b \geq 25$ ⁵⁾	0,9
	rotary drilling only		
Ital. Hollow brick Mattone EN 771-1 LxWxH [mm]: 240x180x100 h_{min} [mm]: 180		$f_b \geq 22$ ⁵⁾	1,5
	rotary drilling only		
Span. Ladrillo cara vista Rojo hidrofugano EN 771-1 LxWxH [mm]: 240x115x50 h_{min} [mm]: 115		$f_b \geq 40$ ⁵⁾	0,6
	rotary drilling only		
French Hollow brick Brique Creuse C EN 771-1 LxWxH [mm]: 210x198x... h_{min} [mm]: 210		$f_b \geq 6$ ⁵⁾	0,5
	rotary drilling only		
Partial safety factor		γ_{Mm} ²⁾	2,5

Footnotes see Annex 12

Hilti frame anchor HRD**Annex 10**Characteristic resistance
in hollow masonry for HRD 8 (use category "c")of European
Technical Approval
ETA-07/0219

Table 12.2: Characteristic resistance for use in hollow masonry (use category “c”) for HRD 10

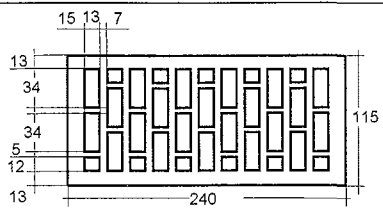
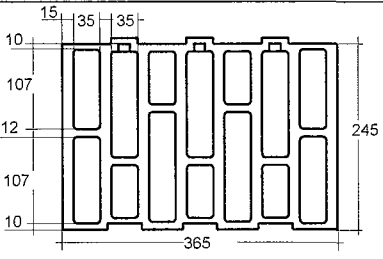
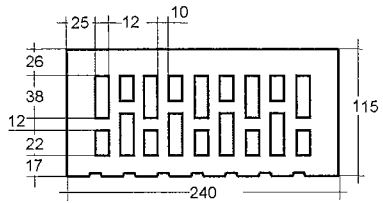
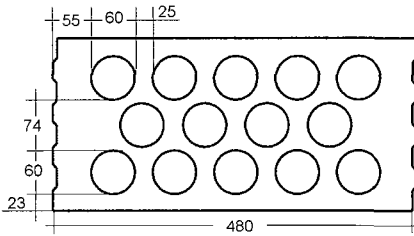
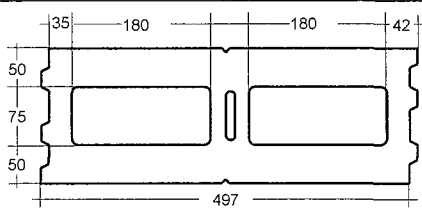
Base material Specifications	Brick dimensions Drilling method	Compressive strength-class [N/mm ²]	$F_{RK}^{4)}$ [kN]	
			$h_{nom,1}=50^{1)}$	$h_{nom,2}=70^{1)}$
Vertically perforated clay brick Hiz 1,0-2DF Manufacturer: Ott Ziegel DIN V 105-100 / EN 771-1 LxWxH [mm]: 240x115x113 h _{min} [mm]: 110		≥ 8	0,4	0,75
		≥ 10	0,5	0,9
		≥ 12	0,6	0,9
		≥ 20	0,9	1,5
hammer drilling				
Vertically perforated clay brick Poroton T8 Manufacturer: Wienerberger Z-17.1-982 LxWxH [mm]: 248x365x249 h _{min} [mm]: 365		≥ 6	0,75	1,5
		rotary drilling only		
Vertically perforated clay brick VHiz 1,6-2DF Manufacturer: Wienerberger DIN V 105-100 / EN 771-1 LxWxH [mm]: 240x115x113 h _{min} [mm]: 115		≥ 28	2,0	2,5
		$f_b \geq 50^{5)}$	3,0	3,5
hammer drilling				
Vertically perforated sand-lime brick KS L R 1,6-16DF Manufacturer: Werk Derching DIN V 106-100 / EN 771-2 LxWxH [mm]: 480x240x248 h _{min} [mm]: 240		≥ 8	0,9	1,2
		≥ 10	1,2	1,5
		≥ 12	1,5	2,0
		≥ 16	2,0	2,5
rotary drilling only				
Lightweight concrete hollow block Hbl 1,2-12DF Manufacturer: KBL DIN V 18151 / EN 771-3 LxWxH [mm]: 497x175x238 h _{min} [mm]: 175		≥ 2	0,5	0,75
		≥ 6	1,2	2,0
rotary drilling only				
Partial safety factor		$\gamma_{Mm}^{2)}$	2,5	

Footnotes see Annex 12

Hilti frame anchor HRD	Annex 11 of European Technical Approval ETA-07/0219
Characteristic resistance in hollow masonry for HRD 10 (use category “c”)	

Table 12.3: Characteristic resistance for use in hollow masonry (use category “c”) for HRD 10

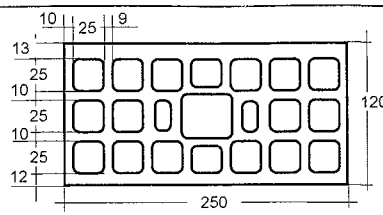
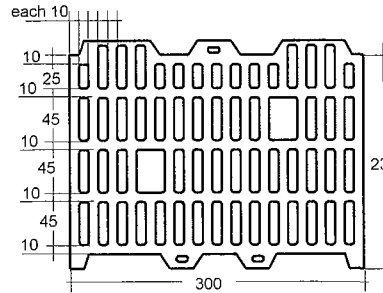
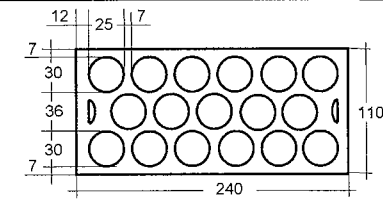
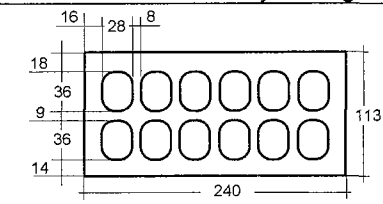
Base material specifications	Brick dimensions Drilling method	Compressive strength–class [N/mm ²]	F _{Rk} ⁴⁾ [kN]	
			h _{nom,1} =50 ¹⁾	h _{nom,2} =70 ¹⁾
Ital. Hollow brick Doppio Uni Manufacturer: Danesi EN 771-1 LxWxH [mm]: 250x120x190 h _{min} [mm]: 120		f _b ≥ 25 ⁵⁾	3)	1,5
rotary drilling only				
Ital. Hollow brick Poroton P700 Manufacturer: Danesi EN 771-1 LxWxH [mm]: 225x300x190 h _{min} [mm]: 300		f _b ≥ 15 ⁵⁾	3)	0,6
rotary drilling only				
Span. Hollow brick Ladrillo perforado Manufacturer: La Oliva EN 771-1 LxWxH [mm]: 240x110x100 h _{min} [mm]: 110		f _b ≥ 26 ⁵⁾	3)	2,0
rotary drilling only				
Span. Hollow brick Clinker mediterraneo Manufacturer: - EN 771-1 LxWxH [mm]: 240x113x50 h _{min} [mm]: 113		f _b ≥ 75 ⁵⁾	3)	1,5
hammer drilling				
Partial safety factor		γ _{Mm} ²⁾	2,5	

- 1) The influence of h_{nom} > 50 mm or h_{nom,1} > 50 mm or h_{nom,2} > 70 mm has to be checked by job-site testing according chapter 4.2.4 and 4.4.
- 2) In absence of other national regulations
- 3) Data can be determined by job site tests
- 4) Characteristic resistance for tension, shear or combined tension and shear loading.
The characteristic resistance is valid for single plastic anchor or for a group of two or four plastic anchors with a spacing equal or larger than the minimum spacing s_{min} according to Table 10. The specific conditions for the design method have to be considered according to chapter 4.2.6 of the ETA.
- 5) Mean compressive strength [N/mm²]

Displacements: see Annex 8, Table 9

Hilti frame anchor HRD	Annex 12 of European Technical Approval ETA-07/0219
Characteristic resistance in hollow masonry for HRD 10 (use category “c”)	

Table 13: Minimum thickness of member, edge distance and anchor spacing in AAC

				HRD 8	HRD 10
Minimum thickness of member	AAC 2	h_{min}	[kN]	-	200
	AAC 6	h_{min}	[kN]	-	240
Minimum allowable edge distance		c_{min}	[mm]	-	100
Minimum allowable spacing (single anchor)		s_{min}	[mm]	-	250
Minimum allowable spacing (anchor group)	perpendicular to free edge	s_{min1}	[mm]	-	200
	parallel to free edge	s_{min2}	[mm]	-	400

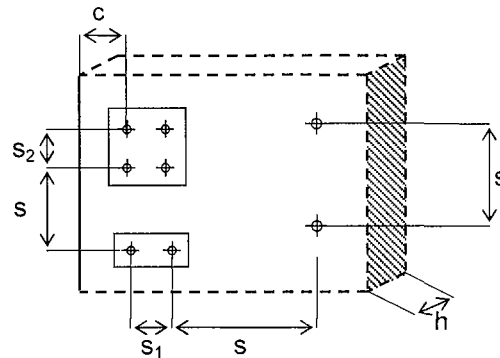
Scheme of distances and spacing**Table 14: Characteristic resistance for use in autoclaved aerated concrete (AAC, use category "d")¹⁾**

				HRD 8	HRD 10	
				-	$h_{nom,2} \geq 70$	$h_{nom,3} \geq 90$
Autoclaved aerated concrete EN 771-4	AAC 2	F_{Rk} ²⁾	[kN]	-	0,9	0,9
	AAC 6	F_{Rk} ²⁾	[kN]	-	3,0	3,0
Partial safety factor		γ_{MAAC} ³⁾		2,0		

1) Drilling method: rotary drilling only

2) Characteristic resistance for tension, shear or combined tension and shear loading.

The characteristic resistance is valid for single plastic anchor or for a group of two or four plastic anchors with spacing equal or larger than the minimum spacing s_{min} according to Table 10. The specific conditions for the design method have to be considered according to chapter 4.2.6 of the ETA.

3) In absence of other national regulations

4) Valid for edge distance $c \geq 150$ mm, intermediate values can be interpolated

Displacements: see Annex 8, Table 9

Hilti frame anchor HRD

Minimum thickness, spacing and edge distance,
characteristic resistance in AAC (use category "d")

Annex 13

of European
Technical Approval
ETA-07/0219