

Deutsches Institut für Bautechnik

Anstalt des öffentlichen Rechts

Kolonnenstr. 30 L
10829 Berlin
Germany

Tel.: +49(0)30 787 30 0
Fax: +49(0)30 787 30 320
E-mail: dibt@dibt.de
Internet: www.dibt.de

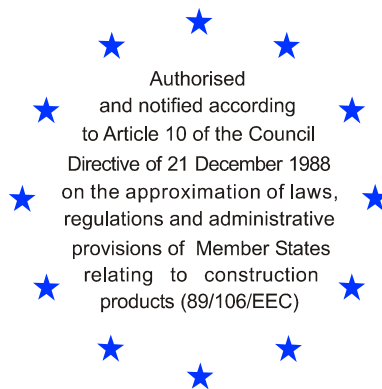

DIBt

Mitglied der EOTA
Member of EOTA

European Technical Approval ETA-08/0237

English translation prepared by DIBt - Original version in German language

Handelsbezeichnung <i>Trade name</i>	Chemofast Injektionssystem STVK und ALVK für Beton <i>Chemofast Injection System STVK and ALVK for concrete</i>
Zulassungsinhaber <i>Holder of approval</i>	CHEMOFAST Anchoring GmbH Hanns-Martin-Schleyer-Straße 23 47877 Willich DEUTSCHLAND
Zulassungsgegenstand und Verwendungszweck <i>Generic type and use of construction product</i>	Verbunddübel mit Ankerstange in den Größen M8 bis M30 und Bewehrungsstahl Ø8 bis Ø32 zur Verankerung im ungerissenen Beton <i>Bonded Anchor with Anchor rod of sizes M8 to M30 or rebar Ø8 to Ø32 for use in non-cracked concrete</i>
Geltungsdauer: <i>Validity:</i>	vom <i>from</i> 8 March 2010 bis <i>to</i> 13 November 2013
Herstellwerk <i>Manufacturing plant</i>	CHEMOFAST Anchoring GmbH

Diese Zulassung umfasst
This Approval contains

22 Seiten einschließlich 14 Anhänge
22 pages including 14 annexes

Diese Zulassung ersetzt
This Approval replaces

ETA-08/0237 mit Geltungsdauer vom 13.11.2008 bis 13.11.2013
ETA-08/0237 with validity from 13.11.2008 to 13.11.2013



Europäische Organisation für Technische Zulassungen
European Organisation for Technical Approvals

I LEGAL BASES AND GENERAL CONDITIONS

- 1 This European technical approval is issued by Deutsches Institut für Bautechnik in accordance with:
 - Council Directive 89/106/EEC of 21 December 1988 on the approximation of laws, regulations and administrative provisions of Member States relating to construction products¹, modified by Council Directive 93/68/EEC² and Regulation (EC) N° 1882/2003 of the European Parliament and of the Council³;
 - Gesetz über das In-Verkehr-Bringen von und den freien Warenverkehr mit Bauprodukten zur Umsetzung der Richtlinie 89/106/EWG des Rates vom 21. Dezember 1988 zur Angleichung der Rechts- und Verwaltungsvorschriften der Mitgliedstaaten über Bauprodukte und anderer Rechtsakte der Europäischen Gemeinschaften (Bauproduktengesetz - BauPG) vom 28. April 1998⁴, as amended by law of 31 October 2006⁵;
 - Common Procedural Rules for Requesting, Preparing and the Granting of European technical approvals set out in the Annex to Commission Decision 94/23/EC⁶;
 - Guideline for European technical approval of "Metal anchors for use in concrete - Part 5: Bonded anchors", ETAG 001-05.
- 2 Deutsches Institut für Bautechnik is authorized to check whether the provisions of this European technical approval are met. Checking may take place in the manufacturing plant. Nevertheless, the responsibility for the conformity of the products to the European technical approval and for their fitness for the intended use remains with the holder of the European technical approval.
- 3 This European technical approval is not to be transferred to manufacturers or agents of manufacturers other than those indicated on page 1, or manufacturing plants other than those indicated on page 1 of this European technical approval.
- 4 This European technical approval may be withdrawn by Deutsches Institut für Bautechnik, in particular pursuant to information by the Commission according to Article 5(1) of Council Directive 89/106/EEC.
- 5 Reproduction of this European technical approval including transmission by electronic means shall be in full. However, partial reproduction can be made with the written consent of Deutsches Institut für Bautechnik. In this case partial reproduction has to be designated as such. Texts and drawings of advertising brochures shall not contradict or misuse the European technical approval.
- 6 The European technical approval is issued by the approval body in its official language. This version corresponds fully to the version circulated within EOTA. Translations into other languages have to be designated as such.

1 Official Journal of the European Communities L 40, 11 February 1989, p. 12

2 Official Journal of the European Communities L 220, 30 August 1993, p. 1

3 Official Journal of the European Union L 284, 31 October 2003, p. 25

4 *Bundesgesetzblatt Teil I 1998*, p. 812

5 *Bundesgesetzblatt Teil I 2006*, p. 2407, 2416

6 Official Journal of the European Communities L 17, 20 January 1994, p. 34

II SPECIFIC CONDITIONS OF THE EUROPEAN TECHNICAL APPROVAL

1 Definition of the product and intended use

1.1 Definition of the construction product

The "Chemofast Injection System STVK and ALVK for concrete" is a bonded anchor consisting of a cartridge with injection mortar STVK and ALVK and a steel element. The steel elements are commercial threaded rods acc. to Annex 3 in the range of M8 to M30 or reinforcing bar acc. to Annex 4 in the range of diameter 8 to 32 mm.

The steel element is placed into a drilled hole filled with injection mortar and is anchored via the bond between metal part, injection mortar and concrete.

An illustration of the product and intended use is given in Annexes 1 and 2.

1.2 Intended use

The anchor is intended to be used for anchorages for which requirements for mechanical resistance and stability and safety in use in the sense of the Essential Requirements 1 and 4 of Council Directive 89/106 EEC shall be fulfilled and failure of anchorages made with these products would cause risk to human life and/or lead to considerable economic consequences. Safety in case of fire (Essential Requirement 2) is not covered in this European technical approval. The anchor is to be used only for anchorages subject to static or quasi-static loading in reinforced or unreinforced normal weight concrete of strength classes C20/25 at minimum and C50/60 at most according to EN 206:2000-12.

The anchor may be used in non-cracked concrete only.

The anchor may be installed in dry or wet concrete.

The anchor sizes M8 to M16 may also be installed in flooded holes.

The anchor may be used in the following temperature ranges:

Temperature range I:	-40 °C to +40 °C	(max long term temperature +24 °C and max short term temperature +40 °C)
Temperature range II:	-40 °C to +80 °C	(max long term temperature +50 °C and max short term temperature +80 °C)

Elements made of zinc coated steel:

The element made of zinc plated or hot dip galvanised steel may only be used in structures subject to dry internal conditions.

Elements made of stainless steel A4:

The element made of stainless steel 1.4401, 1.4404 or 1.4571 may be used in structures subject to dry internal conditions and also in structures subject to external atmospheric exposure (including industrial and marine environment), or exposure to permanently damp internal conditions, if no particular aggressive conditions exist. Such particular aggressive conditions are e.g. permanent, alternating immersion in seawater or the splash zone of seawater, chloride atmosphere of indoor swimming pools or atmosphere with extreme chemical pollution (e.g. in desulphurization plants or road tunnels where de-icing materials are used).

Elements made of high corrosion resistant steel:

The element made of high corrosion resistant steel 1.4529 or 1.4565 may be used in structures subject to dry internal conditions and also in structures subject to external atmospheric exposure, in permanently damp internal conditions or in other particular aggressive conditions. Such particular aggressive conditions are e. g. permanent, alternating immersion in seawater or the splash zone of seawater, chloride atmosphere of indoor swimming pools or atmosphere with chemical pollution (e.g. in desulphurization plants or road tunnels where de-icing materials are used).

Elements made of reinforcing bars:

If the elements made of reinforcing bars are fully embedded in concrete, the concrete cover may be determined depending on the exposition class acc. to EN-1992-1-1 section 4. Otherwise the elements made of reinforcing bars may only be used in structures subject to dry internal conditions.

The provisions made in this European technical approval are based on an assumed working life of the anchor of 50 years. The indications given on the working life cannot be interpreted as a guarantee given by the producer, but are to be regarded only as a means for choosing the right products in relation to the expected economically reasonable working life of the works.

2 Characteristics of the product and methods of verification

2.1 Characteristics of the product

The anchor corresponds to the drawings and provisions given in Annexes 3 and 4. The characteristic material values, dimensions and tolerances of the anchor not indicated in Annexes 3 and 4 shall correspond to the respective values laid down in the technical documentation⁷ of this European technical approval.

The characteristic values for the design of anchorages are given in Annexes 9 to 14.

The two components of the injection mortar are delivered in unmixed condition in coaxial cartridges of sizes 150 ml, 280 ml, 300 ml, 330 ml, 380 ml, 410 ml or 420 ml, in side-by-side cartridges of sizes 235 ml, 345 ml or 825 ml or in foil tube cartridges of sizes 165 ml or 300 ml according to Annex 2. Each cartridge is marked with the imprint "Chemofast STVK" or "Chemofast ALVK", with processing notes, charge code, storage life, hazard code and curing- and processing time depending on temperature.

Elements made of reinforcing bars shall comply with the specifications given in Annex 4.

The marking of embedment depth may be done on jobsite.

2.2 Methods of verification

The assessment of fitness of the anchor for the intended use in relation to the requirements for mechanical resistance and stability and safety in use in the sense of the Essential Requirements 1 and 4 has been made in accordance with the "Guideline for European technical approval of Metal Anchors for Use in Concrete", Part 1 "Anchors in general" and Part 5 "Bonded anchors", on the basis of Option 7.

In addition to the specific clauses relating to dangerous substances contained in this European technical approval, there may be other requirements applicable to the products falling within its scope (e.g. transposed European legislation and national laws, regulations and administrative provisions). In order to meet the provisions of the Construction Products Directive, these requirements need also to be complied with, when and where they apply.

⁷ The technical documentation of this European technical approval is deposited at the Deutsches Institut für Bautechnik and, as far as relevant for the tasks of the approved bodies involved in the attestation of conformity procedure, is handed over to the approved bodies.

3 Evaluation and attestation of conformity and CE marking

3.1 System of attestation of conformity

According to the Decision 96/582/EG of the European Commission⁸ system 2(i) (referred to as System 1) of the attestation of conformity applies.

This system of attestation of conformity is defined as follows:

System 1: Certification of the conformity of the product by an approved certification body on the basis of:

- (a) Tasks for the manufacturer:
 - (1) factory production control;
 - (2) further testing of samples taken at the factory by the manufacturer in accordance with a prescribed control plan;
- (b) Tasks for the approved body:
 - (3) initial type-testing of the product;
 - (4) initial inspection of factory and of factory production control;
 - (5) continuous surveillance, assessment and approval of factory production control.

Note: Approved bodies are also referred to as "notified bodies".

3.2 Responsibilities

3.2.1 Tasks for the manufacturer

3.2.1.1 Factory production control

The manufacturer shall exercise permanent internal control of production. All the elements, requirements and provisions adopted by the manufacturer shall be documented in a systematic manner in the form of written policies and procedures, including records of results performed. This production control system shall insure that the product is in conformity with this European technical approval.

The manufacturer may only use initial/raw/constituent materials stated in the technical documentation of this European technical approval.

The factory production control shall be in accordance with the control plan which is part of the technical documentation of this European technical approval. The control plan is laid down in the context of the factory production control system operated by the manufacturer and deposited at Deutsches Institut für Bautechnik.⁹

The results of factory production control shall be recorded and evaluated in accordance with the provisions of the control plan.

3.2.1.2 Other tasks for the manufacturer

The manufacturer shall, on the basis of a contract, involve a body which is approved for the tasks referred to in section 3.1 in the field of anchors in order to undertake the actions laid down in section 3.2.2 For this purpose, the control plan referred to in sections 3.2.1.1 and 3.2.2 shall be handed over by the manufacturer to the approved body involved.

The manufacturer shall make a declaration of conformity, stating that the construction product is in conformity with the provisions of this European technical approval.

3.2.2 Tasks for the approved bodies

The approved body shall perform the

- initial type-testing of the product,

⁸ Official Journal of the European Communities L 254 of 08.10.1996

⁹ The control plan is a confidential part of the European technical approval and only handed over to the approved body involved in the procedure of attestation of conformity. See section 3.2.2.

- initial inspection of factory and of factory production control,
 - continuous surveillance, assessment and approval of factory production control,
- in accordance with the provisions laid down in the control plan.

The approved body shall retain the essential points of its actions referred to above and state the results obtained and conclusions drawn in a written report.

The approved certification body involved by the manufacturer shall issue an EC certificate of conformity of the product stating the conformity with the provisions of this European technical approval.

In cases where the provisions of the European technical approval and its control plan are no longer fulfilled the certification body shall withdraw the certificate of conformity and inform Deutsches Institut für Bautechnik without delay.

3.3 CE marking

The CE marking shall be affixed on each packaging of the anchor. The letters "CE" shall be followed by the identification number of the approved certification body, where relevant, and be accompanied by the following additional information:

- the name and address of the producer (legal entity responsible for the manufacture),
- the last two digits of the year in which the CE marking was affixed,
- the number of the EC certificate of conformity for the product,
- the number of the European technical approval,
- the number of the guideline for European technical approval,
- use category (ETAG 001-1, Option 7),
- size.

4 Assumptions under which the fitness of the product for the intended use was favourably assessed

4.1 Manufacturing

The European technical approval is issued for the product on the basis of agreed data/information, deposited at Deutsches Institut für Bautechnik, which identifies the product that has been assessed and judged. Changes to the product or production process, which could result in this deposited data/information being incorrect, should be notified to Deutsches Institut für Bautechnik before the changes are introduced. Deutsches Institut für Bautechnik will decide whether or not such changes affect the approval and consequently the validity of the CE marking on the basis of the approval and if so whether further assessment or alterations to the approval shall be necessary.

4.2 Design of anchorages

The fitness of the anchor for the intended use is given under the following conditions:

The anchorages are designed in accordance with the EOTA Technical Report TR 029 "Design of bonded anchors"¹⁰ under the responsibility of an engineer experienced in anchorages and concrete work.

¹⁰ The Technical Report TR 029 "Design of bonded anchors" is published in English on EOTA website www.eota.eu.

Verifiable calculation notes and drawings are prepared taking account of the loads to be anchored.

The position of the anchor is indicated on the design drawings (e.g. position of the anchor relative to reinforcement or to supports, etc.).

4.3 Installation of anchors

The fitness for use of the anchor can only be assumed if the anchor is installed as follows:

- anchor installation carried out by appropriately qualified personnel and under the supervision of the person responsible for technical matters of the site,
- anchor installation in accordance with the manufacturer's specifications and drawings using the tools indicated in the technical documentation of this European technical approval,
- use of the anchor only as supplied by the manufacturer without exchanging the components,
- commercial standard threaded rods, washers and hexagon nuts may be used if the following requirements are fulfilled:
 - material, dimensions and mechanical properties of the metal parts according to the specifications given in Annex 3,
 - confirmation of material and mechanical properties of the metal parts by inspection certificate 3.1 according to EN 10204:2004, the documents should be stored,
 - marking of the threaded rod with the envisage embedment depth. This may be done by the manufacturer of the rod or the person on jobsite.
- embedded reinforcing bars shall comply with specifications given in Annex 4,
- checks before placing the anchor to ensure that the strength class of the concrete in which the anchor is to be placed is in the range given and is not lower than that of the concrete to which the characteristic loads apply,
- check of concrete being well compacted, e.g. without significant voids,
- marking and keeping the effective anchorage depth,
- edge distance and spacing not less than the specified values without minus tolerances,
- positioning of the drill holes without damaging the reinforcement,
- drilling by hammer-drilling,
- in case of aborted drill hole: the drill hole shall be filled with mortar,
- cleaning the drill hole in accordance with Annexes 6 to 8,
- during installation and curing of the chemical mortar the anchor component installation temperature shall be at least -10 °C; the temperature; observing the curing time according to Annex 7, Table 4 until the anchor may be loaded,
- for injection of the mortar in bore holes of diameter $d_0 > 20$ mm piston plugs acc. Annex 8 shall be used for overhead or horizontal injection,
- installation torque moments are not required for functioning of the anchor. However, the torque moments given in Annex 5 must not be exceeded.

5 Recommendations concerning packaging, transport and storage

5.1 Responsibility of the manufacturer

The manufacturer is responsible to ensure that the information on the specific conditions according to 1 and 2 including Annexes referred to and 4.2 and 4.3 is given to those who are concerned. This information may be made by reproduction of the respective parts of the European technical approval.

In addition all installation data shall be shown clearly on the package and/or on an enclosed instruction sheet, preferably using illustration(s).

The minimum data required are:

- drill bit diameter,
- hole depth,
- diameter of anchor rod,
- minimum effective anchorage depth,
- information on the installation procedure, including cleaning of the hole with the cleaning equipments, preferably by means of an illustration,
- anchor component installation temperature,
- ambient temperature of the concrete during installation of the anchor,
- admissible processing time (open time) of the mortar,
- curing time until the anchor may be loaded as a function of the ambient temperature in the concrete during installation,
- maximum torque moment,
- identification of the manufacturing batch,

All data shall be presented in a clear and explicit form.

5.2 Packaging, transport and storage

The cartridges shall be protected against sun radiation and shall be stored according to the manufacturer's installation instructions in dry condition at temperatures of at least +5 °C to not more than +25 °C.

Cartridges with expired shelf life must no longer be used.

The anchor shall only be packaged and supplied as a complete unit. Cartridges may be packed separately from metal parts.

Dipl.-Ing. Georg Feistel
Head of Division Construction Engineering
of Deutsches Institut für Bautechnik
Berlin, 8 March 2010

beglaubigt:
Lange

**Threaded rod M8, M10, M12, M16, M20, M24, M27, M30
with washer and hexagon nut**

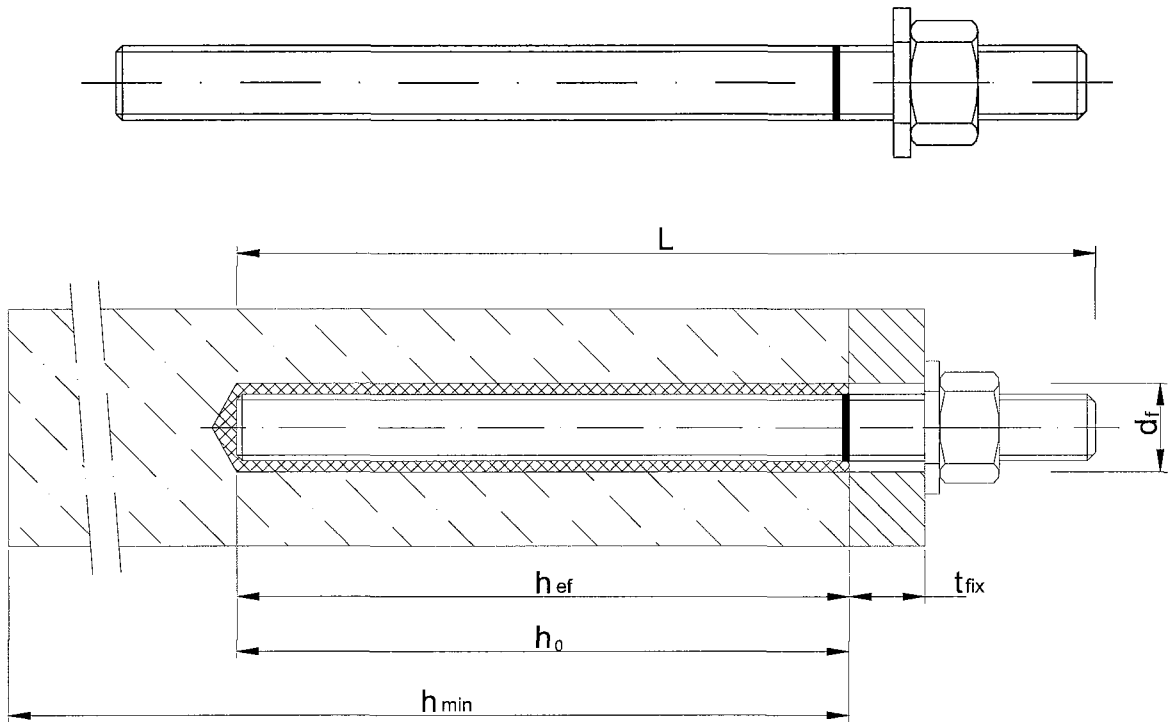

Reinforcing bar $\varnothing 8, \varnothing 10, \varnothing 12, \varnothing 14, \varnothing 16, \varnothing 20, \varnothing 25, \varnothing 28, \varnothing 32$ acc. to Annex 4

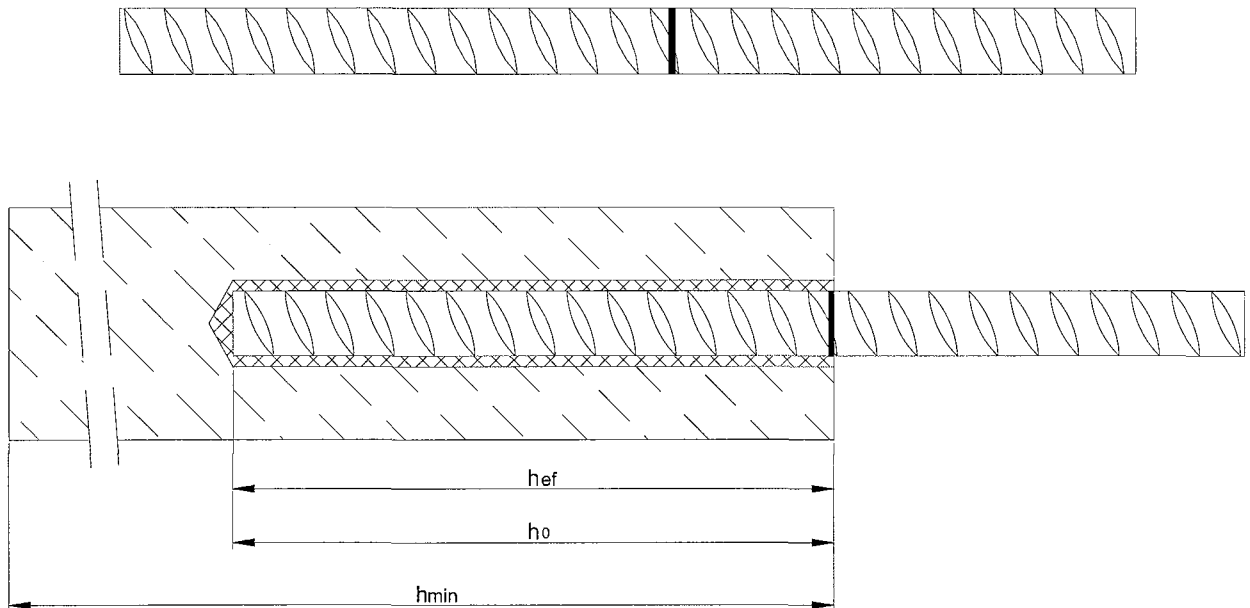

Chemofast Injection system STVK/ALVK for concrete	<p>Annex 1 of European technical approval ETA-08/0237</p>
Product (Steel) and Installation	

Cartridge: Chemofast STVK/ALVK

150 ml, 280 ml, 300 ml, 330 ml, 380 ml, 410 ml and 420 ml cartridge (Type: coaxial)

Sealing/Screw cap

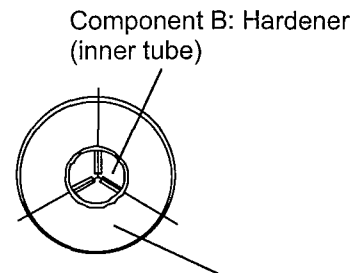
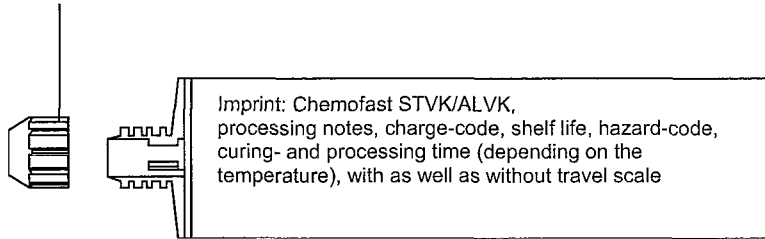

Component A: Injection mortar (outer tube)

235 ml, 345 ml and 825 ml cartridge (Type: "side-by-side")

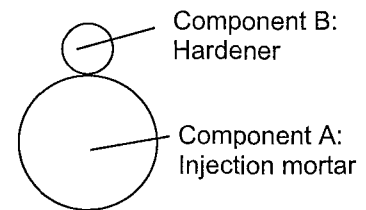
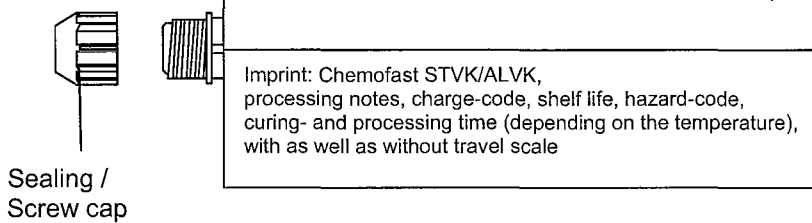

165 ml and 300 ml cartridge (Type: "foil tube")

Sealing / Screw cap

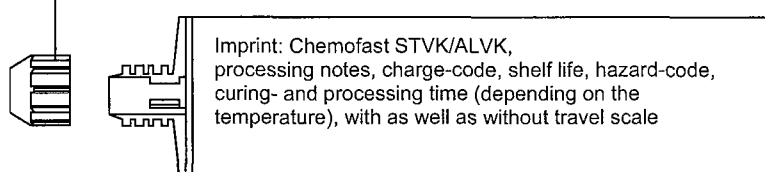

Component B: Hardener and component A: Injection mortar in foil package

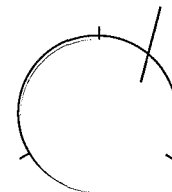

Static Mixer

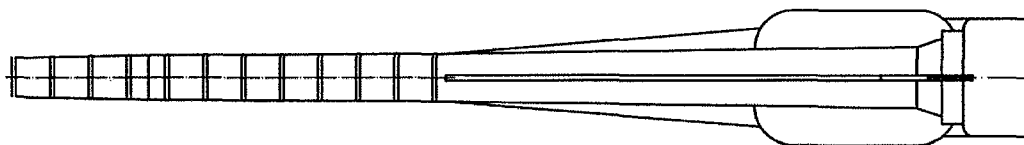

Use category: - Installation in dry, wet concrete or flooded holes
- Overhead installation

Temperature range:
- 40°C to +40°C (max. short term temperature +40°C and max. long term temperature +24°C)
- 40°C to +80°C (max. short term temperature +80°C and max. long term temperature +50°C)

Chemofast Injection system STVK/ALVK for concrete	<p>Annex 2 of European technical approval ETA-08/0237</p>
Product (Injection mortar) and Intended use	

Table 1a: Materials (Threaded rod)

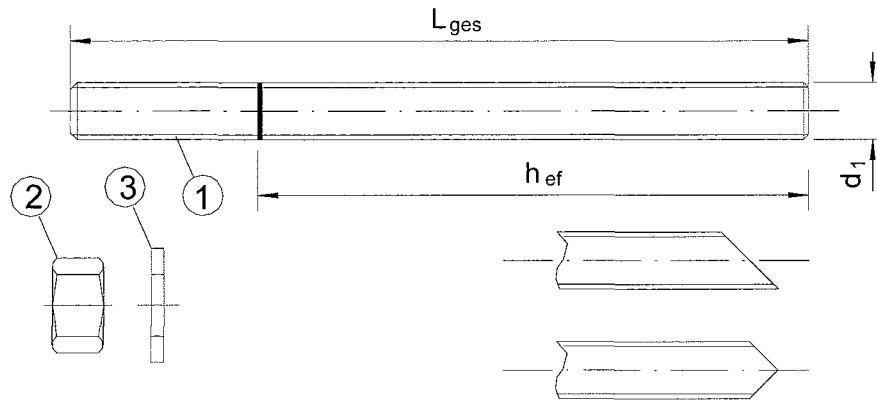

Part	Designation	Material
Steel, zinc plated $\geq 5 \mu\text{m}$ acc. to EN ISO 4042 or Steel, hot-dip galvanised $\geq 40 \mu\text{m}$ acc. to EN ISO 1461 and EN ISO 10684		
1	Anchor rod	Steel, EN 10087 or EN 10263 Property class 5.8, 8.8, EN ISO 898-1:1999
2	Hexagon nut, EN ISO 4032	Property class 5 (for class 5.8 rod) EN 20898-2, Property class 8 (for class 8.8 rod) EN 20898-2
3	Washer, EN ISO 887, EN ISO 7089, EN ISO 7093, or EN ISO 7094	Steel, zinc plated or hot-dip galvanised
Stainless steel		
1	Anchor rod	Material 1.4401 / 1.4404 / 1.4571, EN 10088-1:2005, > M24: Property class 50 EN ISO 3506 \leq M24: Property class 70 EN ISO 3506
2	Hexagon nut, EN ISO 4032	Material 1.4401 / 1.4404 / 1.4571 EN 10088, > M24: Property class 50 (for class 50 rod) EN ISO 3506 \leq M24: Property class 70 (for class 70 rod) EN ISO 3506
3	Washer, EN ISO 887, EN ISO 7089, EN ISO 7093, or EN ISO 7094	Material 1.4401, 1.4404 or 1.4571, EN 10088
High corrosion resistance steel		
1	Anchor rod	Material 1.4529 / 1.4565, EN 10088-1:2005, > M24: Property class 50 EN ISO 3506 \leq M24: Property class 70 EN ISO 3506
2	Hexagon nut, EN ISO 4032	Material 1.4529 / 1.4565 EN 10088, > M24: Property class 50 (for class 50 rod) EN ISO 3506 \leq M24: Property class 70 (for class 70 rod) EN ISO 3506
3	Washer, EN ISO 887, EN ISO 7089, EN ISO 7093, or EN ISO 7094	Material 1.4529 / 1.4565, EN 10088

Commercial standard rod with:

- Materials, dimensions and mechanical properties acc. Table 1a
- Inspection certificate 3.1 acc. to EN 10204:2004
- Marking of embedment depth

Chemofast Injection system STVK/ALVK for concrete

Materials (Threaded rod)

Annex 3

of European
technical approval

ETA-08/0237

Table 1b: Materials (Rebar)

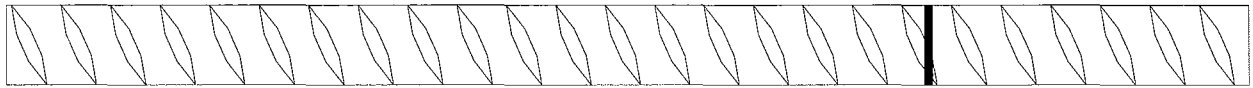

Abstract of EN 1992-1-1 Annex C, Table C.1, Properties of reinforcement:

Product form		Bars and de-coiled rods	
Class		B	C
Characteristic yield strength f_{yk} or $f_{0,2k}$ (N/mm ²)		400 to 600	
Minimum value of $k = (f_t / f_y)_k$		$\geq 1,08$	$\geq 1,15$ < 1,35
Characteristic strain at maximum force ϵ_{uk} (%)		$\geq 5,0$	$\geq 7,5$
Bendability		Bend/Rebend test	
Maximum deviation from nominal mass (individual bar) (%)	Nominal bar size (mm)		
	≤ 8	$\pm 6,0$	
	> 8	$\pm 4,5$	

Abstract of EN 1992-1-1 Annex C, Table C.2N, Properties of reinforcement:

Product form		Bars and de-coiled rods	
Class		B	C
Min. value of related rip area $f_{R,min}$	nominal diameter of the rebar (mm)		
	8 to 12	0,040	
	> 12	0,056	

Rib height of the bar shall be in the range $0,05d \leq h \leq 0,07d$
(d: Nominal diameter of the bar; h: Rip height of the bar)

Regarding design of post-installed rebar as anchor see chapter 4.2.1

Chemofast Injection system STVK/ALVK for concrete

Materials (Reinforcing bar)

Annex 4
of European
technical approval
ETA-08/0237

Table 2: Installation parameters for threaded rod

Anchor size		M 8	M 10	M 12	M 16	M 20	M 24	M 27	M 30	
Nominal drill hole diameter	d_0 [mm] =	10	12	14	18	24	28	32	35	
Embedment depth and bore hole depth	$h_{ef,min}$ [mm] =	60	60	70	80	90	96	108	120	
	$h_{ef,max}$ [mm] =	160	200	240	320	400	480	540	600	
Diameter of clearance hole in the fixture	d_f [mm] ≤	9	12	14	18	22	26	30	33	
Diameter of steel brush	d_b [mm] ≥	12	14	16	20	26	30	34	37	
Torque moment	T_{inst} [Nm]	10	20	40	80	120	160	180	200	
Thickness of fixture	$t_{fix,min}$ [mm] >	0								
	$t_{fix,max}$ [mm] <	1500								
Minimum thickness of member	h_{min} [mm]	$h_{ef} + 30$ mm ≥ 100 mm			$h_{ef} + 2d_0$					
Minimum spacing	s_{min} [mm]	40	50	60	80	100	120	135	150	
Minimum edge distance	c_{min} [mm]	40	50	60	80	100	120	135	150	

Table 3: Installation parameters for rebar

Rebar size		Ø 8	Ø 10	Ø 12	Ø 14	Ø 16	Ø 20	Ø 25	Ø 28	Ø 32
Nominal drill hole diameter	d_0 [mm] =	12	14	16	18	20	24	32	35	40
Embedment depth and bore hole depth	$h_{ef,min}$ [mm] =	60	60	70	75	80	90	100	112	128
	$h_{ef,max}$ [mm] =	160	200	240	280	320	400	480	540	640
Diameter of steel brush	d_b [mm] ≥	14	16	18	20	22	26	34	37	41,5
Minimum thickness of member	h_{min} [mm]	$h_{ef} + 30$ mm ≥ 100 mm			$h_{ef} + 2d_0$					
Minimum spacing	s_{min} [mm]	40	50	60	70	80	100	125	140	160
Minimum edge distance	c_{min} [mm]	40	50	60	70	80	100	125	140	160

Chemofast Injection system STVK/ALVK for concrete

Installation parameters

Annex 5of European
technical approval**ETA-08/0237**

Assembly instructions

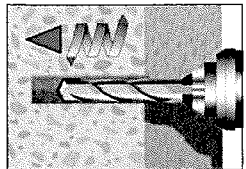
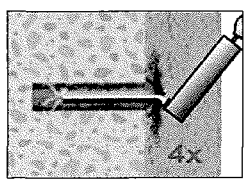
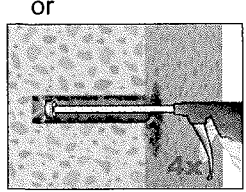
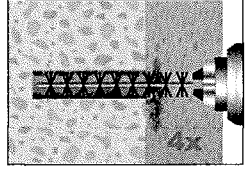
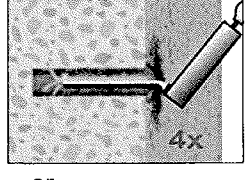
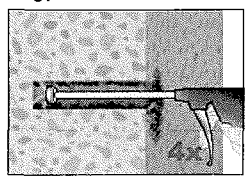
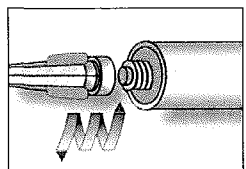
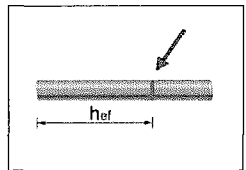
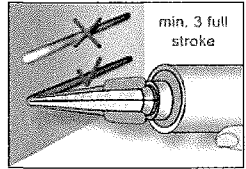
	<p>1 Drill with hammer drill a hole into the base material to the size and embedment depth required by the selected anchor (Table 2 or Table 3).</p>
	<p>2a Starting from the bottom or back of the bore hole, blow the hole clean with compressed air or a hand pump (Annex 8) a minimum of four times. If the bore hole ground is not reached an extension shall be used.</p> <p>The hand-pump can be used for anchor sizes up to bore hole diameter 20 mm.</p>
<p>or</p> 	<p>For bore holes larger than 20 mm or deeper 240 mm, compressed air (min. 6 bar) must be used.</p>
	<p>2b Check brush diameter (Table 5) and attach the brush to a drilling machine or a battery screwdriver. Brush the hole with an appropriate sized wire brush > $d_{b,min}$ (Table 5) a minimum of four times. If the bore hole ground is not reached with the brush, a brush extension shall be used (Table 5).</p>
	<p>2c Finally blow the hole clean again with compressed air or a hand pump (Annex 8) a minimum of four times. If the bore hole ground is not reached an extension shall be used.</p> <p>The hand-pump can be used for anchor sizes up to bore hole diameter 20 mm.</p>
<p>or</p> 	<p>For bore holes larger than 20 mm or deeper 240 mm, compressed air (min. 6 bar) must be used.</p>
	<p>3 Attach a supplied static-mixing nozzle to the cartridge and load the cartridge into the correct dispensing tool. Cut off the foil tube clip before use. For every working interruption longer than the recommended working time (Table 4) as well as for new cartridges, a new static-mixer shall be used.</p>
	<p>4 Prior to inserting the anchor rod into the filled bore hole, the position of the embedment depth shall be marked on the anchor rods.</p>
	<p>5 Prior to dispensing into the anchor hole, squeeze out separately a minimum of three full strokes and discard non-uniformly mixed adhesive components until the mortar shows a consistent grey colour.</p>

Chemofast Injection system STVK/ALVK for concrete

Assembly instructions

Annex 6

of European technical approval

ETA-08/0237

Assembly instructions (continuation)

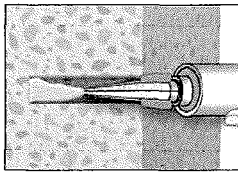

6 Starting from the bottom or back of the cleaned anchor hole fill the hole up to approximately two-thirds with adhesive. Slowly withdraw the static mixing nozzle as the hole fills to avoid creating air pockets. For embedment larger than 190 mm an extension nozzle shall be used. For overhead and horizontal installation in bore holes larger than \varnothing 20 mm a piston plug and extension nozzle (Annex 8) shall be used. Observe the gel-/ working times given in Table 4.

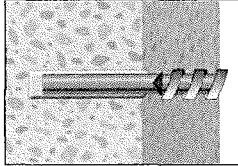

7 Push the threaded rod or reinforcing bar into the anchor hole while turning slightly to ensure positive distribution of the adhesive until the embedment depth is reached.

The anchor should be free of dirt, grease, oil or other foreign material.

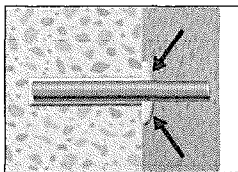

8 Be sure that the anchor is fully seated at the bottom of the hole and that excess mortar is visible at the top of the hole. If these requirements are not maintained, the application has to be renewed.

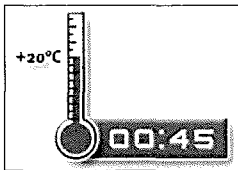

9 Allow the adhesive to cure to the specified time prior to applying any load or torque. Do not move or load the anchor until it is fully cured (attend Table 4).

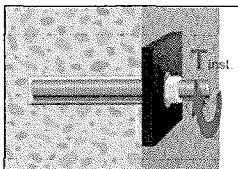

10 After full curing, the add-on part can be installed with the max. torque (Table 2) by using a calibrated torque wrench.

Table 4: Minimum curing time

Concrete temperature	Gelling- / working time	Minimum curing time in dry concrete ²⁾
≥ -10 °C ¹⁾	90 min	24 h
≥ -5 °C	90 min	14 h
≥ 0 °C	45 min	7 h
$\geq +5$ °C	25 min	2 h
$\geq +10$ °C	15 min	80 min
$\geq +20$ °C	6 min	45 min
$\geq +30$ °C	4 min	25 min
$\geq +35$ °C	2 min	20 min
$\geq +40$ °C	1,5 min	15 min

1) Cartridge temperature **must** be at min. +15°C

2) In wet concrete the curing time **must** be doubled

Chemofast Injection system STVK/ALVK for concrete

Assembly instructions (continuation)
Curing time

Annex 7
of European
technical approval
ETA-08/0237

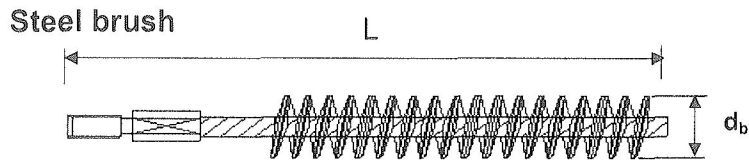
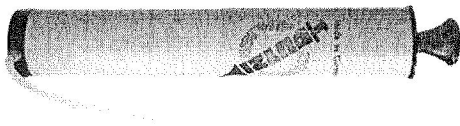

Table 5: Parameter cleaning and setting tools

Threaded rod	Rebar	d ₀ Drill bit - Ø	d _b Brush - Ø	d _{b,min} min. Brush - Ø	L Total length	Piston plug
(mm)	(mm)	(mm)	(mm)	(mm)	(mm)	(No.)
M8		10	12	10,5	170	-
M10	8	12	14	12,5	170	-
M12	10	14	16	14,5	200	-
	12	16	18	16,5	200	-
M16	14	18	20	18,5	300	-
	16	20	22	20,5	300	-
M20	20	24	26	24,5	300	# 24
M24		28	30	28,5	300	# 28
M27	25	32	34	32,5	300	# 32
M30	28	35	37	35,5	300	# 35
	32	40	41,5	40,5	300	# 38



Hand pump (volume 750 ml)
Drill bit diameter (d₀): 10 mm to 20 mm



Rec. compressed air tool (min 6 bar)
Drill bit diameter (d₀): 10 mm to 40 mm

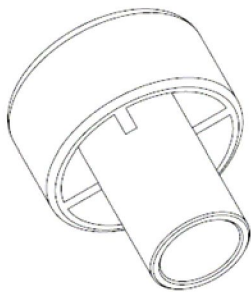

Piston plug for overhead or horizontal installation
Drill bit diameter (d₀): 24 mm to 40 mm

Chemofast Injection system STVK/ALVK for concrete

Cleaning and setting tools

Annex 8
of European
technical approval
ETA-08/0237

**Table 6: Design method A:
Characteristic values for tension loads**

Anchor size threaded rod			M 8	M 10	M 12	M 16	M 20	M24	M 27	M 30	
Steel failure											
Characteristic tension resistance, Steel, property class 5.8	$N_{Rk,s}$	[kN]	18	29	42	78	122	176	230	280	
Characteristic tension resistance, Steel, property class 8.8	$N_{Rk,s}$	[kN]	29	46	67	125	196	282	368	449	
Partial safety factor	$\gamma_{Ms,N}^{1)}$		1,50								
Characteristic tension resistance, Stainless steel A4 and HCR, property class 50 (>M24) and 70 (\leq M24)	$N_{Rk,s}$	[kN]	26	41	59	110	171	247	230	281	
Partial safety factor	$\gamma_{Ms,N}^{1)}$		1,87						2,86		
Combined pullout and concrete cone failure											
Characteristic bond resistance in non-cracked concrete C20/25											
dry and wet concrete	Temperature range I ⁵⁾ : 40°C/24°C	$\tau_{Rk,uncr}$	[N/mm ²]	10	12	12	12	12	11	10	9
	Temperature range II ⁵⁾ : 80°C/50°C	$\tau_{Rk,uncr}$	[N/mm ²]	7,5	9	9	9	9	8,5	7,5	6,5
	Partial safety factor	$\gamma_{Mc} = \gamma_{Mp}^{1)}$		1,5 ²⁾		1,8 ³⁾					
flooded bore hole	Temperature range I ⁵⁾ : 40°C/24°C	$\tau_{Rk,uncr}$	[N/mm ²]	7,5	8,5	8,5	8,5	not admissible			
	Temperature range II ⁵⁾ : 80°C/50°C	$\tau_{Rk,uncr}$	[N/mm ²]	5,5	6,5	6,5	6,5				
	Partial safety factor	$\gamma_{Mc} = \gamma_{Mp}^{1)}$		2,1 ⁴⁾							
Increasing factors for non-cracked concrete ψ_c	C30/37		1,04								
	C40/50		1,08								
	C50/60		1,10								
Splitting failure											
Edge distance	$c_{cr,sp}$	[mm]	$1,0 \cdot h_{ef} \leq 2 \cdot h_{ef} \left(2,5 - \frac{h}{h_{ef}} \right) \leq 2,4 \cdot h_{ef}$								
Axial distance	$s_{cr,sp}$	[mm]	$2 c_{cr,sp}$								
Partial safety factor (dry and wet concrete)	$\gamma_{Msp}^{1)}$		1,5 ²⁾		1,8 ³⁾						
Partial safety factor (flooded bore hole)	$\gamma_{Msp}^{1)}$		2,1 ⁴⁾						-	-	-

¹⁾ In absence of other national regulations

²⁾ The partial safety factor $\gamma_2 = 1.0$ is included.

³⁾ The partial safety factor $\gamma_2 = 1.2$ is included.

⁴⁾ The partial safety factor $\gamma_2 = 1.4$ is included.

⁵⁾ Explanations see section 1.2

Chemofast Injection system STVK/ALVK for concrete

Application with threaded rod
Design method A:
Characteristic values for tension loads

Annex 9

of European
technical approval

ETA-08/0237

**Tabelle 7: Design method A:
Characteristic values for shear loads**

Anchor size threaded rod		M 8	M 10	M 12	M 16	M 20	M 24	M 27	M 30
Steel failure without lever arm									
Characteristic shear resistance, Steel, property class 5.8	$V_{Rk,s}$ [kN]	9	15	21	39	61	88	115	140
Characteristic shear resistance, Steel, property class 8.8	$V_{Rk,s}$ [kN]	15	23	34	63	98	141	184	224
Partial safety factor	$\gamma_{Ms,V}^{1)}$	1,25							
Characteristic shear resistance, Stainless steel A4 and HCR, property class 50 (>M24) and 70 (\leq M24)	$V_{Rk,s}$ [kN]	13	20	30	55	86	124	115	140
Partial safety factor	$\gamma_{Ms,V}^{1)}$	1,56						2,38	
Steel failure with lever arm									
Characteristic bending moment, Steel, property class 5.8	$M^0_{Rk,s}$ [Nm]	19	37	65	166	324	560	833	1123
Characteristic bending moment, Steel, property class 8.8	$M^0_{Rk,s}$ [Nm]	30	60	105	266	519	896	1333	1797
Partial safety factor	$\gamma_{Ms,V}^{1)}$	1,25							
Characteristic bending moment, Stainless steel A4 and HCR, property class 50 (>M24) and 70 (\leq M24)	$M^0_{Rk,s}$ [Nm]	26	52	92	232	454	784	832	1125
Partial safety factor	$\gamma_{Ms,V}^{1)}$	1,56						2,38	
Concrete pryout failure									
Factor k in equation (5.7) of Technical Report TR 029 for the design of Bonded Anchors		2,0							
Partial safety factor	$\gamma_{Mcp}^{1)}$	1,50 ²⁾							
Concrete edge failure									
See section 5.2.3.4 of Technical Report TR 029 for the design of Bonded Anchors									
Partial safety factor	$\gamma_{Mc}^{1)}$	1,50 ²⁾							

¹⁾ In absence of other national regulations

²⁾ The partial safety factor $\gamma_2 = 1.0$ is included.

Chemofast Injection system STVK/ALVK for concrete

Application with threaded rod
Design method A:
Characteristic values for shear loads

Annex 10

of European
technical approval

ETA-08/0237

Table 8: Displacements for tension loads ¹⁾

Anchor size threaded rod			M 8	M 10	M 12	M 16	M 20	M24	M 27	M 30
Temperature range 40°C/24°C										
Displacement	δ_{N0}	[mm/(N/mm ²)]	0,021	0,023	0,026	0,031	0,036	0,041	0,045	0,049
Displacement	$\delta_{N\infty}$	[mm/(N/mm ²)]	0,030	0,033	0,037	0,045	0,052	0,060	0,065	0,071
Temperature range 80°C/50°C										
Displacement	δ_{N0}	[mm/(N/mm ²)]	0,050	0,056	0,063	0,075	0,088	0,100	0,110	0,119
Displacement	$\delta_{N\infty}$	[mm/(N/mm ²)]	0,072	0,081	0,090	0,108	0,127	0,145	0,159	0,172

¹⁾ Calculation of the displacement for design load
Displacement for short term load = $\delta_{N0} \cdot \tau_{Sd} / 1,4$;
Displacement for long term load = $\delta_{N\infty} \cdot \tau_{Sd} / 1,4$;
(τ_{Sd} : design bond strength)

Table 9: Displacement for shear load ²⁾

Anchor size threaded rod			M 8	M 10	M 12	M 16	M 20	M24	M 27	M 30
Displacement	δ_{V0}	[mm/(kN)]	0,06	0,06	0,05	0,04	0,04	0,03	0,03	0,03
Displacement	$\delta_{V\infty}$	[mm/(kN)]	0,09	0,08	0,08	0,06	0,06	0,05	0,05	0,05

²⁾ Calculation of the displacement for design load
Displacement for short term load = $\delta_{N0} \cdot V_d / 1,4$;
Displacement for long term load = $\delta_{N\infty} \cdot V_d / 1,4$;
(V_d : design shear load)

Chemofast Injection system STVK/ALVK for concrete

Application with threaded rod
Displacements**Annex 11**of European
technical approval**ETA-08/0237**

**Table 10: Design method A:
Characteristic values for tension loads**

Anchor size reinforcing bar		Ø 8	Ø 10	Ø 12	Ø 14	Ø 16	Ø 20	Ø 25	Ø 28	Ø 32	
Steel failure (Properties acc. to Annex 4)											
Characteristic tension resistance, BSt 500 S acc. DIN 488-2:1986 or E DIN 488-2:2006 ⁶⁾	$N_{Rk,s}$ [kN]	28	43	62	85	111	173	270	339	442	
Partial safety factor	$\gamma_{Ms,N}$ ¹⁾	1,40									
Combined pullout and concrete cone failure											
Characteristic bond resistance in uncracked concrete C20/25											
dry and wet concrete	Temperature range I ⁵⁾ : 40°C/24°C	$\tau_{Rk,uncr}$ [N/mm ²]	8,5	10	10	10	10	10	9,0	8,0	7,0
	Temperature range II ⁵⁾ : 80°C/50°C	$\tau_{Rk,uncr}$ [N/mm ²]	6,0	7,5	7,5	7,5	7,5	7,5	7,0	6,0	5,0
	Partial safety factor	$\gamma_{Mc} = \gamma_{Mp}$ ¹⁾	1,5 ²⁾	1,8 ³⁾							
flooded bore hole	Temperature range I ⁵⁾ : 40°C/24°C	$\tau_{Rk,uncr}$ [N/mm ²]	6,0	7,5	7,5	7,5	7,5	not admissible			
	Temperature range II ⁵⁾ : 80°C/50°C	$\tau_{Rk,uncr}$ [N/mm ²]	4,5	5,5	5,5	5,5	5,5				
	Partial safety factor	$\gamma_{Mc} = \gamma_{Mp}$ ¹⁾	2,1 ⁴⁾								
Increasing factors for non-cracked concrete	C30/37	1,04									
	C40/50	1,08									
	C50/60	1,10									
Ψ_c											
Splitting failure											
Edge distance	$c_{cr,sp}$ [mm]	$1,0 \cdot h_{ef} \leq 2 \cdot h_{ef} \left(2,5 - \frac{h}{h_{ef}} \right) \leq 2,4 \cdot h_{ef}$									
Axial distance	$s_{cr,sp}$ [mm]	$2 c_{cr,sp}$									
Partial safety factor (dry and wet concrete)	γ_{Msp} ¹⁾	1,5 ²⁾	1,8 ³⁾								
Partial safety factor (flooded bore hole)	γ_{Msp} ¹⁾	2,1 ⁴⁾				-	-	-	-	-	

¹⁾ In absence of other national regulations

²⁾ The partial safety factor $\gamma_2 = 1.0$ is included.

³⁾ The partial safety factor $\gamma_2 = 1.2$ is included.

⁴⁾ The partial safety factor $\gamma_2 = 1.4$ is included.

⁵⁾ Explanations see section 1.2

⁶⁾ For reinforcing bars which do not comply with DIN 488: The characteristic resistance $N_{Rk,s}$ shall be determined acc. to Technical Report TR 029, equation (5.1).

Regarding design of post-installed rebar as anchor see chapter 4.2.1

Chemofast Injection system STVK/ALVK for concrete

Application with reinforcing bar
Design method A:
Characteristic values for tension loads

Annex 12
of European
technical approval
ETA-08/0237

**Tabelle 11: Design method A:
Characteristic values for shear loads**

Anchor size reinforcing bar		Ø 8	Ø 10	Ø 12	Ø 14	Ø 16	Ø 20	Ø 25	Ø 28	Ø 32
Steel failure without lever arm (Properties acc. Annex 4)										
Characteristic shear resistance, BSt 500 S acc. DIN 488-2:1986 or E DIN 488-2:2006 ³⁾	$V_{Rk,s}$ [kN]	14	22	31	42	55	86	135	169	221
Partial safety factor	$\gamma_{Ms,V}$ ¹⁾	1,5								
Steel failure with lever arm (Properties acc. Annex 4)										
Characteristic bending moment, BSt 500 S acc. DIN 488-2:1986 or E DIN 488-2:2006 ⁴⁾	$M^0_{Rk,s}$ [Nm]	33	65	112	178	265	518	1012	1422	2123
Partial safety factor	$\gamma_{Ms,V}$ ¹⁾	1,5								
Concrete pryout failure										
Factor k in equation (5.7) of Technical Report TR 029 for the design of bonded anchors		2,0								
Partial safety factor	γ_{Mcp} ¹⁾	1,50 ²⁾								
Concrete edge failure										
See section 5.2.3.4 of Technical Report TR 029 for the design of Bonded Anchors										
Partial safety factor	γ_{Mc} ¹⁾	1,50 ²⁾								

¹⁾ In absence of other national regulations

²⁾ The partial safety factor $\gamma_2 = 1.0$ is included.

³⁾ For reinforcing bars which do not comply with DIN 488: The characteristic resistance $V_{Rk,s}$ shall be determined acc. to Technical Report TR 029, equation (5.5).

⁴⁾ For reinforcing bars which do not comply with DIN 488: The characteristic resistance $M^0_{Rk,s}$ shall be determined acc. to Technical Report TR 029, equation (5.6b).

Regarding design of post-installed rebar as anchor see chapter 4.2.1

Chemofast Injection system STVK/ALVK for concrete

Application with reinforcing bar
Design method A:
Characteristic values for shear loads

Annex 13

of European
technical approval

ETA-08/0237

Table 12: Displacements for tension loads ¹⁾

Anchor size reinforcing bar			Ø 8	Ø 10	Ø 12	Ø 14	Ø 16	Ø 20	Ø 25	Ø 28	Ø 32
Temperature range 40°C/24°C											
Displacement	δ_{N0}	[mm/(N/mm ²)]	0,021	0,023	0,026	0,028	0,031	0,036	0,043	0,047	0,052
Displacement	$\delta_{N\infty}$	[mm/(N/mm ²)]	0,030	0,033	0,037	0,041	0,045	0,052	0,061	0,071	0,075
Temperature range 80°C/50°C											
Displacement	δ_{N0}	[mm/(N/mm ²)]	0,050	0,056	0,063	0,069	0,075	0,088	0,104	0,113	0,126
Displacement	$\delta_{N\infty}$	[mm/(N/mm ²)]	0,072	0,081	0,090	0,099	0,108	0,127	0,149	0,163	0,181

¹⁾ Calculation of the displacement for design load
Displacement for short term load = $\delta_{N0} \cdot \tau_{Sd} / 1,4$;
Displacement for long term load = $\delta_{N\infty} \cdot \tau_{Sd} / 1,4$;
(τ_{Sd} : design bond strength)

Table 13: Displacement for shear load ²⁾

BST 500 S			Ø 8	Ø 10	Ø 12	Ø 14	Ø 16	Ø 20	Ø 25	Ø 28	Ø 32
Displacement	δ_{V0}	[mm/(kN)]	0,06	0,05	0,05	0,04	0,04	0,04	0,03	0,03	0,03
Displacement	$\delta_{V\infty}$	[mm/(kN)]	0,09	0,08	0,08	0,06	0,06	0,05	0,05	0,04	0,04

²⁾ Calculation of the displacement for design load
Displacement for short term load = $\delta_{N0} \cdot V_d / 1,4$;
Displacement for long term load = $\delta_{N\infty} \cdot V_d / 1,4$;
(V_d : design shear load)

Chemofast Injection system STVK/ALVK for concrete

Application with reinforcing bar
Displacements
Annex 14
of European
technical approval
ETA-08/0237