

Deutsches Institut für Bautechnik

Anstalt des öffentlichen Rechts

Kolonnenstr. 30 L
10829 Berlin
Germany

Tel.: +49(0)30 787 30 0
Fax: +49(0)30 787 30 320
E-mail: dibt@dibt.de
Internet: www.dibt.de

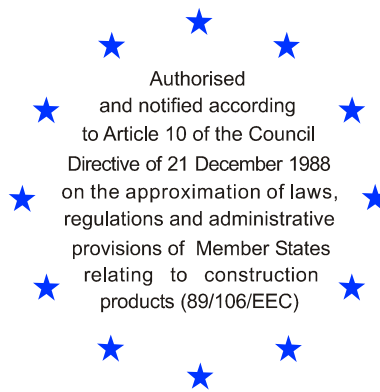

DIBt

Mitglied der EOTA
Member of EOTA

European Technical Approval ETA-09/0160

English translation prepared by DIBt - Original version in German language

Handelsbezeichnung <i>Trade name</i>	BTI Universalverbundtechnik UVT 300 Top <i>BTI Universal bonded anchor engineering UVT 300 Top</i>
Zulassungsinhaber <i>Holder of approval</i>	BTI Befestigungstechnik GmbH Salzstraße 51 74653 Ingelfingen DEUTSCHLAND
Zulassungsgegenstand und Verwendungszweck <i>Generic type and use of construction product</i>	Verbunddübel in den Größen M6 bis M30 zur Verankerung im ungerissenen Beton <i>Bonded anchor in the size of M6 to M30 for use in non-cracked concrete</i>
Geltungsdauer: <i>Validity:</i>	vom <i>from</i> 3 September 2010 bis <i>to</i> 29 October 2012
Herstellwerk <i>Manufacturing plant</i>	BTI Herstellwerk 1

Diese Zulassung umfasst
This Approval contains

21 Seiten einschließlich 13 Anhänge
21 pages including 13 annexes

Diese Zulassung ersetzt
This Approval replaces

ETA-09/0160 mit Geltungsdauer vom 22.06.2009 bis 29.10.2012
ETA-09/0160 with validity from 22.06.2009 to 29.10.2012



Europäische Organisation für Technische Zulassungen
European Organisation for Technical Approvals

I LEGAL BASES AND GENERAL CONDITIONS

- 1 This European technical approval is issued by Deutsches Institut für Bautechnik in accordance with:
 - Council Directive 89/106/EEC of 21 December 1988 on the approximation of laws, regulations and administrative provisions of Member States relating to construction products¹, modified by Council Directive 93/68/EEC² and Regulation (EC) N° 1882/2003 of the European Parliament and of the Council³;
 - Gesetz über das In-Verkehr-Bringen von und den freien Warenverkehr mit Bauprodukten zur Umsetzung der Richtlinie 89/106/EWG des Rates vom 21. Dezember 1988 zur Angleichung der Rechts- und Verwaltungsvorschriften der Mitgliedstaaten über Bauprodukte und anderer Rechtsakte der Europäischen Gemeinschaften (Bauproduktengesetz - BauPG) vom 28. April 1998⁴, as amended by law of 31 October 2006⁵;
 - Common Procedural Rules for Requesting, Preparing and the Granting of European technical approvals set out in the Annex to Commission Decision 94/23/EC⁶;
 - Guideline for European technical approval of "Metal anchors for use in concrete - Part 5: Bonded anchors", ETAG 001-05.
- 2 Deutsches Institut für Bautechnik is authorized to check whether the provisions of this European technical approval are met. Checking may take place in the manufacturing plant. Nevertheless, the responsibility for the conformity of the products to the European technical approval and for their fitness for the intended use remains with the holder of the European technical approval.
- 3 This European technical approval is not to be transferred to manufacturers or agents of manufacturers other than those indicated on page 1, or manufacturing plants other than those indicated on page 1 of this European technical approval.
- 4 This European technical approval may be withdrawn by Deutsches Institut für Bautechnik, in particular pursuant to information by the Commission according to Article 5(1) of Council Directive 89/106/EEC.
- 5 Reproduction of this European technical approval including transmission by electronic means shall be in full. However, partial reproduction can be made with the written consent of Deutsches Institut für Bautechnik. In this case partial reproduction has to be designated as such. Texts and drawings of advertising brochures shall not contradict or misuse the European technical approval.
- 6 The European technical approval is issued by the approval body in its official language. This version corresponds fully to the version circulated within EOTA. Translations into other languages have to be designated as such.

1 Official Journal of the European Communities L 40, 11 February 1989, p. 12

2 Official Journal of the European Communities L 220, 30 August 1993, p. 1

3 Official Journal of the European Union L 284, 31 October 2003, p. 25

4 *Bundesgesetzblatt Teil I 1998*, p. 812

5 *Bundesgesetzblatt Teil I 2006*, p. 2407, 2416

6 Official Journal of the European Communities L 17, 20 January 1994, p. 34

II SPECIFIC CONDITIONS OF THE EUROPEAN TECHNICAL APPROVAL

1 Definition of the product and intended use

1.1 Definition of the construction product

The Injection system BTI Universal bonded anchor engineering UVT 300 Top is a bonded anchor (injection type) consisting of a mortar cartridge with BTI injection mortar UVT 300 TOP and a steel element. The steel element is an anchor rod UVT Top A with hexagon nut and washer in the range of M6 to M30 or an internal threaded anchor UVT Top I in the range of M8 to M20. The steel elements are made of zinc coated steel, stainless steel (marking "A4") or high corrosion resistant steel (marking "C").

The steel element is placed into a drilled hole filled with injection mortar and is anchored via the bond between steel element, injection mortar and concrete.

An illustration of the product and intended use is given in Annex 1.

1.2 Intended use

The anchor is intended to be used for anchorages for which requirements for mechanical resistance and stability and safety in use in the sense of the Essential Requirements 1 and 4 of Council Directive 89/106 EEC shall be fulfilled and failure of anchorages made with these products would cause risk to human life and/or lead to considerable economic consequences. Safety in case of fire (Essential Requirement 2) is not covered in this European technical approval. The anchor is to be used only for anchorages subject to static or quasi-static loading in reinforced or unreinforced normal weight concrete of strength classes C20/25 at minimum and C50/60 at most according to EN 206:2000-12.

The anchor may be used in non-cracked concrete only.

The anchor may be installed in dry or wet concrete; it must not be installed in flooded holes.

The drill hole shall be made by hammer drilling or compressed air drilling.

The anchor may be used in the following service temperature ranges:

Temperature range I:	-40 °C to +80 °C	(max long term temperature +50 °C and max short term temperature +80 °C)
Temperature range II:	-40 °C to +120 °C	(max long term temperature +72 °C and max short term temperature +120 °C)

Elements made of zinc coated steel:

The element made of electroplated or hot-dipped galvanised steel may only be used in structures subject to dry internal conditions.

Elements made of stainless steel:

The element made of stainless steel may be used in structures subject to dry internal conditions and also in structures subject to external atmospheric exposure (including industrial and marine environment), or exposure in permanently damp internal conditions, if no particular aggressive conditions exist. Such particular aggressive conditions are e.g. permanent, alternating immersion in seawater or the splash zone of seawater, chloride atmosphere of indoor swimming pools or atmosphere with extreme chemical pollution (e.g. in desulphurization plants or road tunnels where de-icing materials are used).

Elements made of high corrosion resistant steel:

The element made of high corrosion resistant steel may be used in structures subject to dry internal conditions and also in structures subject to external atmospheric exposure, in permanently damp internal conditions or in other particular aggressive conditions. Such particular aggressive conditions are e.g. permanent, alternating immersion in seawater or the splash zone of seawater, chloride atmosphere of indoor swimming pools or atmosphere with chemical pollution (e.g. in desulphurization plants or road tunnels where de-icing materials are used).

The provisions made in this European technical approval are based on an assumed working life of the anchor of 50 years. The indications given on the working life cannot be interpreted as a guarantee given by the producer, but are to be regarded only as a means for choosing the right products in relation to the expected economically reasonable working life of the works.

2 Characteristics of the product and methods of verification

2.1 Characteristics of product

The anchor corresponds to the drawings and provisions given in Annexes 1 to 3. The characteristic material values, dimensions and tolerances of the anchor not indicated in Annexes 1 to 3 shall correspond to the respective values laid down in the technical documentation⁷ of this European technical approval.

The characteristic anchor values for the design of anchorages are given in Annexes 6 to 13.

Each anchor rod UVT Top A is marked with the identifying mark of the producer and property class in accordance with Annex 2. Each anchor rod UVT Top A made of stainless steel A4 is marked with the additional letter "A4" and each anchor rod UVT Top A made of high corrosion resistant steel is marked with the additional letter "C".

Each internal threaded anchor UVT Top I is marked with the marking of steel grade and length in accordance with Annex 2. Each internal threaded anchor UVT Top I made of stainless steel A4 is marked with the additional letter "A4". Each internal threaded anchor UVT Top I made of high corrosion resistant steel is marked with the additional letter "C".

Each mortar cartridge is marked with the identifying mark of the producer and with the trade name in accordance with Annex 1.

The two components of the BTI injection mortar UVT 300 TOP are delivered in unmixed condition in coaxial cartridges of 150 ml, 300 ml, 380 ml or 400ml according to Annex 1.

2.2 Methods of verification

The assessment of fitness of the anchor for the intended use in relation to the requirements for mechanical resistance and stability and safety in use in the sense of the Essential Requirements 1 and 4 has been made in accordance with the "Guideline for European technical approval of Metal Anchors for Use in Concrete", Part 1 "Anchors in general" and Part 5 "Bonded anchors" on the basis of Option 7.

⁷ The technical documentation of this European technical approval is deposited at the Deutsches Institut für Bautechnik and, as far as relevant for the tasks of the approved bodies involved in the attestation of conformity procedure, is handed over to the approved bodies.

In addition to the specific clauses relating to dangerous substances contained in this European technical approval, there may be other requirements applicable to the products falling within its scope (e.g. transposed European legislation and national laws, regulations and administrative provisions). In order to meet the provisions of the Construction Products Directive, these requirements need also to be complied with, when and where they apply.

3 Evaluation and attestation of conformity and CE marking

3.1 System of attestation of conformity

According to the Decision 96/582/EG of the European Commission⁸ system 2(i) (referred to as System 1) of the attestation of conformity applies.

This system of attestation of conformity is defined as follows:

System 1: Certification of the conformity of the product by an approved certification body on the basis of:

- (a) Tasks for the manufacturer:
 - (1) factory production control;
 - (2) further testing of samples taken at the factory by the manufacturer in accordance with a prescribed control plan;
- (b) Tasks for the approved body:
 - (3) initial type-testing of the product;
 - (4) initial inspection of factory and of factory production control;
 - (5) continuous surveillance, assessment and approval of factory production control.

Note: Approved bodies are also referred to as "notified bodies".

3.2 Responsibilities

3.2.1 Tasks for the manufacturer

3.2.1.1 Factory production control

The manufacturer shall exercise permanent internal control of production. All the elements, requirements and provisions adopted by the manufacturer shall be documented in a systematic manner in the form of written policies and procedures, including records of results performed. This production control system shall insure that the product is in conformity with this European technical approval.

The manufacturer may only use initial/raw/constituent materials stated in the technical documentation of this European technical approval.

The factory production control shall be in accordance with the control plan which is part of the technical documentation of this European technical approval. The control plan is laid down in the context of the factory production control system operated by the manufacturer and deposited with Deutsches Institut für Bautechnik.⁹

The results of factory production control shall be recorded and evaluated in accordance with the provisions of the control plan.

⁸ Official Journal of the European Communities L 254 of 08.10.1996

⁹ The control plan is a confidential part of the European technical approval and only handed over to the approved body involved in the procedure of attestation of conformity. See section 3.2.2.

3.2.1.2 Other tasks for the manufacturer

The manufacturer shall, on the basis of a contract, involve a body which is approved for the tasks referred to in section 3.1 in the field of anchors in order to undertake the actions laid down in section 3.2.2 For this purpose, the control plan referred to in sections 3.2.1.1 and 3.2.2 shall be handed over by the manufacturer to the approved body involved.

The manufacturer shall make a declaration of conformity, stating that the construction product is in conformity with the provisions of this European technical approval.

3.2.2 Tasks for the approved bodies

The approved body shall perform the

- initial type-testing of the product,
- initial inspection of factory and of factory production control,
- continuous surveillance, assessment and approval of factory production control,

in accordance with the provisions laid down in the control plan.

The approved body shall retain the essential points of its actions referred to above and state the results obtained and conclusions drawn in a written report.

The approved certification body involved by the manufacturer shall issue an EC certificate of conformity of the product stating the conformity with the provisions of this European technical approval.

In cases where the provisions of the European technical approval and its control plan are no longer fulfilled the certification body shall withdraw the certificate of conformity and inform Deutsches Institut für Bautechnik without delay.

3.3 CE marking

The CE marking shall be affixed on each packaging of the anchor. The letters "CE" shall be followed by the identification number of the approved certification body, where relevant, and be accompanied by the following additional information:

- the name and address of the holder of the approval (legal entity responsible for the manufacture),
- the last two digits of the year in which the CE marking was affixed,
- the number of the EC certificate of conformity for the product,
- the number of the European technical approval,
- the number of the guideline for European technical approval
- use category (ETAG 001-1, Option 7)
- size

4 Assumptions under which the fitness of the product for the intended use was favourably assessed

4.1 Manufacturing

The European technical approval is issued for the product on the basis of agreed data/information, deposited with Deutsches Institut für Bautechnik, which identifies the product that has been assessed and judged. Changes to the product or production process, which could result in this deposited data/information being incorrect, should be notified to Deutsches Institut für Bautechnik before the changes are introduced. Deutsches Institut für Bautechnik will decide whether or not such changes affect the approval and consequently the validity of the CE marking on the basis of the approval and if so whether further assessment or alterations to the approval shall be necessary.

4.2 Design of anchorages

The fitness of the anchor for the intended use is given under the following conditions:

The anchorages are designed in accordance with the EOTA Technical Report TR 029 "Design of bonded anchors"¹⁰ under the responsibility of an engineer experienced in anchorages and concrete work.

Verifiable calculation notes and drawings are prepared taking account of the loads to be anchored.

The position of the anchor is indicated on the design drawings (e.g. position of the anchor relative to reinforcement or to supports, etc.).

4.3 Installation of anchors

The fitness for use of the anchor can only be assumed if the anchor is installed as follows:

- anchor installation carried out by appropriately qualified personnel and under the supervision of the person responsible for technical matters of the site,
- use of the anchor only as supplied by the manufacturer without exchanging the components of an anchor,
- anchor installation in accordance with the manufacturer's specifications and drawings using the tools indicated in the technical documentation of this European technical approval,
- commercial standard threaded rods, washers and hexagon nuts may also be used if the following requirements are fulfilled:
 - material, dimensions and mechanical properties of the metal parts according to the specifications given in Annex 3, Table 2,
 - confirmation of material and mechanical properties of the metal parts by inspection certificate 3.1 according to EN 10204:2004, the documents should be stored,
 - marking of the threaded rod with the envisage embedment depth. This may be done by the manufacturer of the rod or the person on jobsite.
- checks before placing the anchor to ensure that the strength class of the concrete in which the anchor is to be placed is in the range given and is not lower than that of the concrete to which the characteristic loads apply,
- check of concrete being well compacted, e.g. without significant voids,
- marking and keeping the effective anchorage depth,
- edge distance and spacing not less than the specified values without minus tolerances,
- positioning of the drill holes without damaging the reinforcement,
- drilling by hammer drilling or compressed air drilling,
- in case of aborted drill hole: the drill hole shall be filled with mortar,
- the anchor must not be installed in flooded holes,
- anchor installation in accordance with manufacturers installation instructions (Annex 5)
- the anchor component installation temperature shall be at least 5 °C; during curing of the chemical mortar the temperature of the concrete must not fall below 0 °C; observing the curing time according to Annex 3, Table 3 until the anchor may be loaded,
- fastening screws or threaded rods (including nut and washer) for the internal threaded anchor must be made of appropriate steel grade and property class,
- installation torque moments are not required for functioning of the anchor. However, the torque moments given in Annex 4, Table 4 must not be exceeded.

¹⁰ The Technical Report TR 029 "Design of Bonded Anchors" is published in English on EOTA website www.eota.eu.

5 Indications to the manufacture

5.1 Responsibility of the manufacturer

It is in the responsibility of the manufacturer to ensure that the information on the specific conditions according to 1 and 2 including Annexes referred to as well as sections 4.2, 4.3 and 5.2 is given to those who are concerned. This information may be made by reproduction of the respective parts of the European technical approval. In addition all installation data shall be shown clearly on the package and/or on an enclosed instruction sheet, preferably using illustration(s).

The minimum data required are:

- drill bit;
- hole depth;
- diameter of anchor rod;
- minimum effective anchorage depth;
- information on the installation procedure, including cleaning of the hole with the cleaning equipments, preferably by means of an illustration;
- anchor component installation temperature;
- material and property class of metal parts acc. to Annex 3, Table 2,
- ambient temperature of the concrete during installation of the anchor;
- admissible processing time (open time) of a cartridge;
- curing time until the anchor may be loaded as a function of the ambient temperature in the concrete during installation;
- torque moment;
- identification of the manufacturing batch.

All data shall be presented in a clear and explicit form.

5.2 Packaging, transport and storage

The injection cartridges shall be protected against sun radiation and shall be stored according to the manufacture's installation instructions in dry condition at temperatures of at least +5 °C to not more than +25 °C.

Mortar cartridges with expired shelf life must no longer be used.

The Anchor shall only be packaged and supplied as a complete unit. Injection cartridges and the elements for in-place anchorages being packed separately from anchor rods, nuts and washers or internal threaded anchor.

Georg Feistel
Head of Department

beglaubigt:
Tempel

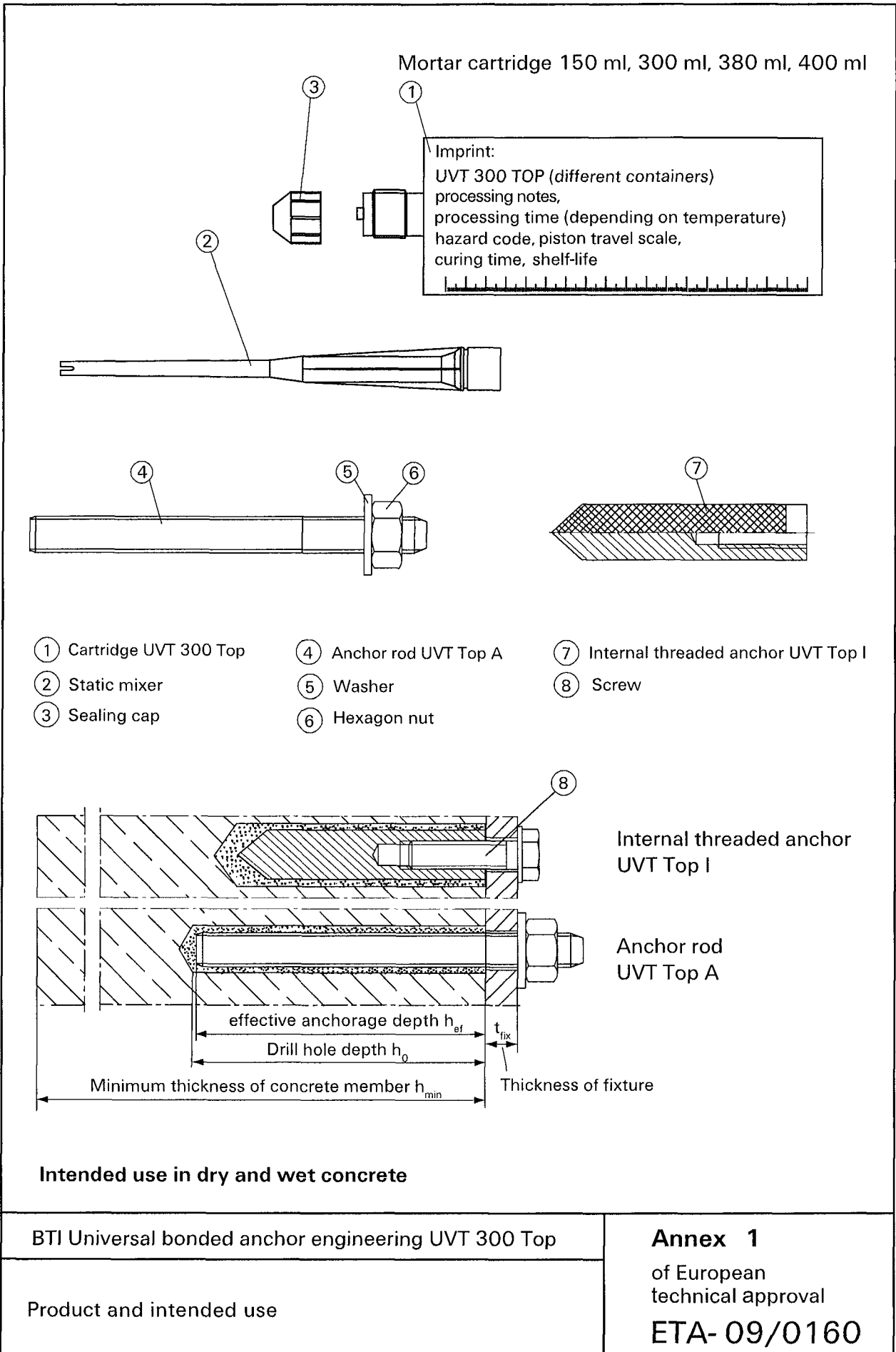

Anchor rod UVT Top A: M6, M8, M10, M12, M16, M20, M24, M30

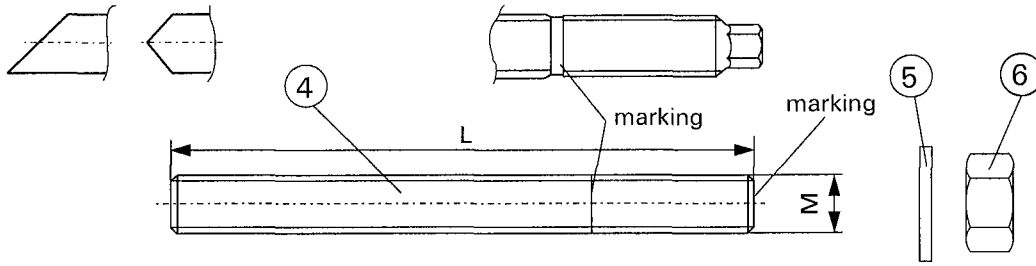

Marking:
 Property class 8.8: •
 Stainless steel: **A4**
 High corrosion-resistant steel: **C**

Internal threaded anchor UVT Top I

Marking:
 Anchor size.
 Stainless steel additional: **A4**
 High corrosion-resistant steel additional: **C**

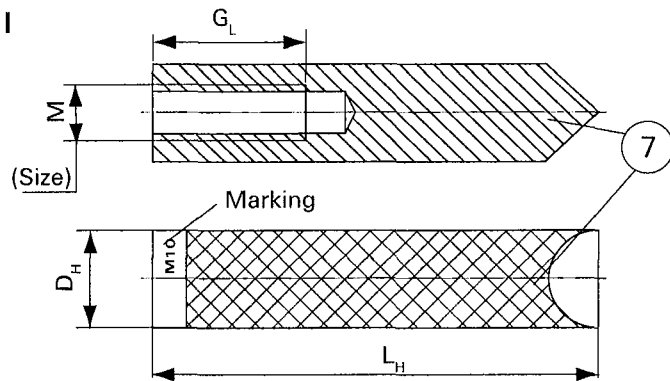

Temperature range:

Temperature range I: -40°C to +80°C (max long term temperature +50°C and max short term temperature +80°C)

Temperature range II: -40°C to +120°C (max long term temperature +72°C and max short term temperature +120°C)

Table 1: Anchor dimensions

Size		M6	M8	M10	M12	M16	M20	M24	M30
Anchor rod UVT Top A									
Effective anchorage depth	$h_{ef\ min}$ [mm]	50	64	80	96	125	160	192	240
	$h_{ef\ max}$ [mm]	72	96	120	144	192	240	288	360
Length of threaded rod	L_{min} [mm]	60	75	95	115	150	190	230	280
	L_{max} [mm]	1500							
Internal threaded anchor UVT Top I									
Diameter	D_H [mm]	—	12,5	16,5	18,5	22,5	28,5	—	—
Length	L_H [mm]	—	90	90	125	160	200	—	—
Length of thread	G_L [mm]	—	20	25	30	40	50	—	—

BTI Universal bonded anchor engineering UVT 300 Top

Anchor dimensions
 Temperatur ranges

Annex 2

of European technical approval

ETA- 09/0160

Table 2: Materials

Part	Designation	Materials		
1	Chemical mortar	Reaction resin, mortar, hardener, additive		
		Steel, zinc plated	Stainless steel	High corrosions-resistant steel
4	Anchor rod	Property class 5.8 or 8.8; EN ISO 898-1 zinc plated $\geq 5\mu\text{m}$, EN ISO 4042 A2K or hot-dip galvanised $\geq 45\mu\text{m}$, EN ISO 10684	Property class A4-70 EN ISO 3506-1 EN 10088	EN 10088
5	Washer	EN ISO 898-1 zinc plated $\geq 5\mu\text{m}$, EN ISO 4042 A2K or hot-dip galvanised $\geq 45\mu\text{m}$, EN ISO 10684	EN 10088	
6	Hexagon nut according to EN 24 032	Property class 5 or 8 or 10; EN 20898-2 zinc plated $\geq 5\mu\text{m}$, EN ISO 4042 A2K or hot-dip galvanised $\geq 45\mu\text{m}$, EN ISO 10684	Property class A4-70 EN ISO 3506-1 EN 10088	
7	Internal threaded anchor	Property class 5.8 or 8.8; EN ISO 898-1 zinc plated $\geq 5\mu\text{m}$, EN ISO 4042 A2K or hot-dip galvanised $\geq 45\mu\text{m}$, EN ISO 10684	Property class A4-70 EN ISO 3506-1 EN 10088	
8	Screw for internal threaded anchor UVT Top I			

Table 3: Processing time of the mortar and minimum curing time

(During the curing time of the mortar the concrete temperature may not fall below the listed minimum temperature).

Concrete temperature [°C]	Minimum curing time ¹⁾ [minutes]	System-temperature (mortar) [°C]	Processing time [minutes]
0 to +5	6 hours	+ 5	—
+5 to +10	3 hours	+ 10	20
+10 to +20	2 hours	+ 20	10
+20 to +30	60	+ 30	6
+30 to +40	30	+ 40	4

¹⁾For wet concrete the curing time must be doubled.

BTI Universal bonded anchor engineering UVT 300 Top

Materials
Processing time and curing time

Annex 3

of European
technical approval

ETA- 09/0160

Table 4: Installation parameters

Anchor rods UVT Top A										
Size of anchor		M6	M8	M10	M12	M16	M20	M24	M30	
Nominal drill hole diameter	$d_0 = [\text{mm}]$	8	10	12	14	18	24	28	35	
Cutting diameter of drill bit	$d_{\text{cut}} \leq [\text{mm}]$	8,45	10,45	12,50	14,50	18,50	24,55	28,55	35,70	
Depth of drill hole	$h_0 = [\text{mm}]$	$h_0 \geq h_{\text{ef}}$								
Diameter of clearance hole in the fixture	$d_f \leq [\text{mm}]$	7	9	12	14	18	22	26	33	
Diameter of steel brush	$d_b = [\text{mm}]$	9	11	13	16	20	26	30	40	
Torque moment	$T_{\text{inst}} = [\text{Nm}]$	5	10	20	40	60	120	150	300	
Thickness of fixture	t_{fix} min [mm]	0								
	max [mm]	1500								

Internal threaded anchor UVT Top I

Size of anchor		M8	M10	M12	M16	M20
Nominal drill hole diameter	$d_0 = [\text{mm}]$	14	18	20	24	32
Cutting diameter of drill bit	$d_{\text{cut}} \leq [\text{mm}]$	14,5	18,5	20,5	24,55	32,55
Depth of drill hole for h_{ef}	$h_0 \geq [\text{mm}]$	90	90	125	160	200
Diameter of clearance hole in the fixture	$d_f \geq [\text{mm}]$	9	12	14	18	22
Diameter of steel brush	$d_b = [\text{mm}]$	16	20	21,5	26	40
Torque moment	$T_{\text{inst}} = [\text{Nm}]$	10	20	40	80	120
Min. screw-in depth	[mm]	12	15	18	24	30
Max. screw-in depth	[mm]	18	23	26	35	45

Steel brush



BTI Universal bonded anchor engineering UVT 300 Top

Installation parameters
Steel brush

Annex 4

of European
technical approval

ETA- 09/0160

Installation of the anchor rod UVT Top A and internal threaded anchor UVT Top I

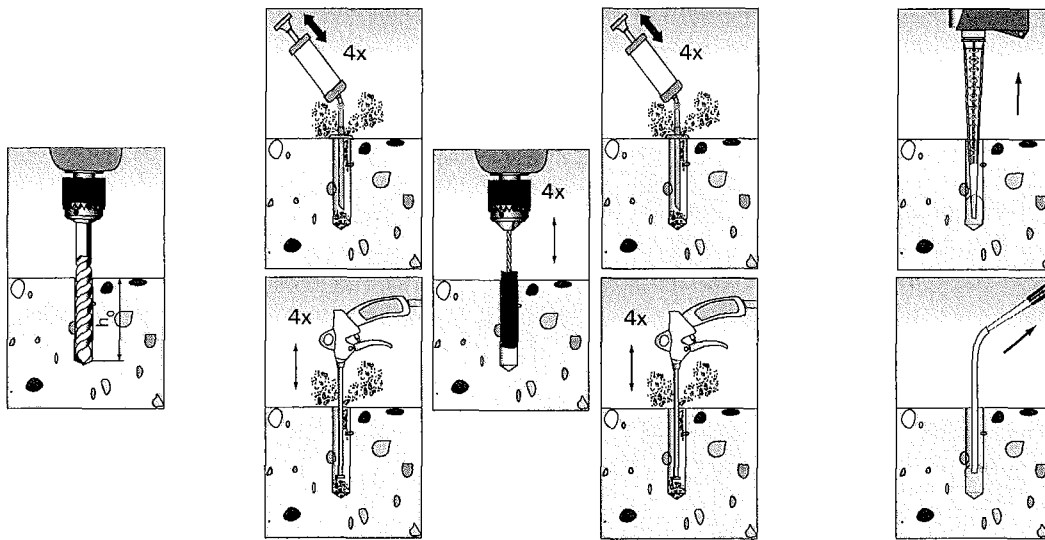

1) Drill hole.
(Depth of drill hole h_0 see Table 4)

2) Clean the hole: Blow out the drill hole four times, brush four times and blow out four times again.
For drill hole diameter ≥ 18 mm use oilfree pressure air ($P > 6$ bar).

3) Fill approx. 2/3 of the drill hole with mortar beginning from the surface of the hole.
For drill hole diameter ≥ 150 mm use an extension hose.

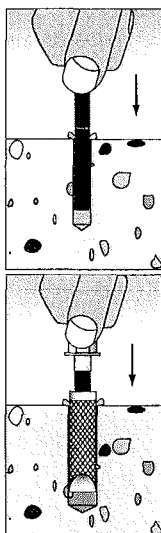

4) Insert the UVT Top A or internal threaded anchor UVT Top I by hand using light turning motions until it reaches the setting depth marking. Excess mortar must exit the drill hole



Do not touch.
 t_{cure} see Table 3

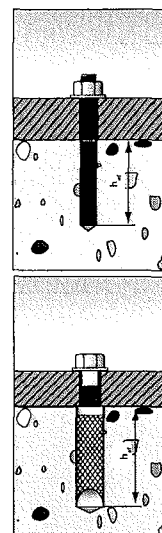

5) Mounting the fixture
 T_{inst} see Table 4

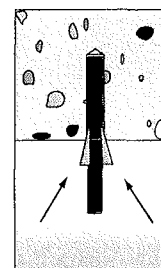

Overhead installation: support with wedges

Table 5: Minimum distances and member thicknesses

Anchor rod UVT Top A								
Anchor size	M6		M8		M10		M12	
	$h_{ef,min}$	$h_{ef,max}$	$h_{ef,min}$	$h_{ef,max}$	$h_{ef,min}$	$h_{ef,max}$	$h_{ef,min}$	$h_{ef,max}$
effective anchorage depth ¹⁾ h_{ef} [mm]	50	72	64	96	80	120	96	144
minimum thickness of concrete member h_{min} [mm]	$h_{ef} + 30 \text{ mm} \geq 100 \text{ mm}$							
minimum edge distance and $\min s = \min c$ [mm] spacing	40				45		55	
Anchor size	M16		M20		M24		M30	
	$h_{ef,min}$	$h_{ef,max}$	$h_{ef,min}$	$h_{ef,max}$	$h_{ef,min}$	$h_{ef,max}$	$h_{ef,min}$	$h_{ef,max}$
effective anchorage depth ¹⁾ h_{ef} [mm]	125	192	160	240	192	288	240	360
minimum thickness of concrete member h_{min} [mm]	$h_{ef} + 2d_0$							
minimum edge distance and $\min s = \min c$ [mm] spacing	65		85		105		140	
Internal threaded anchor UVT Top I								
Anchor size	M8	M10	M12	M16	M20			
effective anchorage depth h_{ef} [mm]	90	90	125	160	200			
minimum thickness of concrete member h_{min} [mm]	120	125	165	205	260			
minimum edge distance and $\min s = \min c$ [mm] spacing	40	45	60	80	125			

¹⁾ Anchorage depth $h_{ef,min} \leq h_{ef} \leq h_{ef,max}$ is possible. The minimum member thickness may be interpolate straight proportional.

BTI Universal bonded anchor engineering UVT 300 Top

Minimum distances and
minimum member thicknesses**Annex 6**of European
technical approval**ETA- 09/0160**

Table 6: Design of Bonded Anchors acc. to TR 029
Characteristic values to tension loads
anchor rods UVT Top A

Steel failure										
Anchor size		M6	M8	M10	M12	M16	M20	M24	M30	
Characteristic resistance $N_{Rk,s}$	property	5.8 [kN]	11	19	30	44	82	127	183	292
	class	8.8 [kN]	16	29	46	67	126	196	282	449
	A4 - 70	[kN]	14	26	41	59	110	171	247	392
	C	[kN]	14	26	41	59	110	171	247	392
Partial safety factor $\gamma_{Ms}^{1)}$	property	5.8 [-]	1,48							
	class	8.8 [-]	1,50							
	A4 - 70	[-]	1,87							
	C	[-]	1,50							
Combined pullout and concrete failure										
Diameter for calculation d [mm]		6	8	10	12	16	20	24	30	
Embedment depth ³⁾ h_{ef}	$h_{ef,min}$ [mm]	50	64	80	96	125	160	192	240	
	$h_{ef,max}$ [mm]	72	96	120	144	192	240	288	360	
Temperature range I (-40°C/+80°C)										
Characteristic bond resistance in non-cracked concrete C20/25 $\tau_{Rk,ucr}$ [N/mm ²]		9	11	11	11	10	9,5	9	8,5	
Temperature range II (-40°C/+120°C)										
Characteristic bond resistance $\tau_{Rk,ucr}$ [N/mm ²]		6,5	9,5	9,5	9,0	8,5	8,0	7,5	7,0	
Edge distance		$c_{cr,Np} = \frac{s_{cr,Np}}{2}$ [mm]								
Spacing		$s_{cr,Np} = 20 \cdot d \cdot \left(\frac{\tau_{Rk,p}}{7,5}\right)^{0,5} \leq 3h_{ef}$ [mm]								
Increasing factors ψ_c	C25/30 [-]	1,05								
	C30/37 [-]	1,10								
	C35/45 [-]	1,15								
	C40/50 [-]	1,19								
	C45/55 [-]	1,22								
	C50/60 [-]	1,26								
Partial safety factor $\gamma_{Mc} = \gamma_{Mp}^{1)}$ [-]		1,8 ²⁾								

¹⁾ In absence of other national regulations.

²⁾ The partial safety factor $\gamma_2 = 1,2$ is included.

³⁾ $h_{ef,min} \leq h_{ef} \leq h_{ef,max}$ is possible.

BTI Universal bonded anchor engineering UVT 300 Top

Design of Bonded Anchors acc. to TR 029
 Characteristic values to tension loads
 anchor rods UVT Top A

Annex 7

of European
 technical approval

ETA- 09/0160

Tabelle 7: Design of Bonded Anchor acc. to TR 029
Characteristic values of splitting failure
anchor rods UVT Top A

Dübelgröße	M6		M8		M10		M12		M16		M20		M24		M30	
³⁾ h _{ef,min} [mm]	50	72	64	96	80	120	96	144	125	192	160	240	192	288	240	360
²⁾ h _{min} [mm]	h _{ef} + 30 mm ≥ 100 mm								h _{ef} + 2d _o							
c _{cr,sp} [mm]	100	200	160	205	200	260	240	310	315	415	395	515	475	620	590	770
h ¹⁾ [mm]	100	144	128	192	160	240	192	288	250	384	320	480	384	576	480	720
c _{cr,sp} [mm]	100	150	120	150	150	185	180	225	240	300	300	370	360	445	450	555

¹⁾ $h \geq 2h_{ef}$

²⁾ For member thickness $h_{min} \leq h \leq 2h_{ef}$ the characteristic edge distances and spacing can be derived by linear interpolation.

³⁾ $h_{ef,min} \leq h_{ef} \leq h_{ef,max}$ is possible

BTI Universal bonded anchor engineering UVT 300 Top

Design of Bonded Anchor acc. to TR 029
 Characteristic values of splitting failure
 anchor rods UVT Top A

Annex 8

of European
 technical approval

ETA- 09/0160

Table 8: Design of Bonded Anchor acc. to TR029
Characteristic values to tension load
Internal threaded anchor UVT Top I

Anchor size			M8	M10	M12	M16	M20	
Effective anchorage depth	h_{ef} [mm]		90	90	125	160	200	
Steel failure								
Characteristic resistance	property	5.8 $N_{Rk,s}$ [kN]	19	30	44	82	127	
	class	8.8 $N_{Rk,s}$ [kN]	29	46	67	109	182	
		A4-70 $N_{Rk,s}$ [kN]	26	41	59	110	171	
		C $N_{Rk,s}$ [kN]	26	41	59	110	171	
Partial safety factor	property	5.8 $\gamma_{Ms}^{1)}$ [-]	1,48					
	class	8.8 $\gamma_{Ms}^{1)}$ [-]	1,50					
		A4-70 $\gamma_{Ms}^{1)}$ [-]	1,87					
		C $\gamma_{Ms}^{1)}$ [-]	1,50					
Combined pullout and concrete con failure								
Temperature range I (-40°C to +80°C)								
Characteristic resistance	C20/25	$N_{Rk,p}^0$ ³⁾ [kN]	30	40	50	75	115	
Edge distance		$c_{cr,Np}$ ³⁾ [mm]	135	135	187,5	240	295	
Spacing		$s_{cr,Np}$ ³⁾ [mm]	270	270	375	480	590	
Temperature range II (-40°C to +120°C)								
Characteristic resistance	C20/25	$N_{Rk,p}^0$ ³⁾ [kN]	25	30	40	60	95	
Edge distance		$c_{cr,Np}$ ³⁾ [mm]	135	135	180	220	270	
Spacing		$s_{cr,Np}$ ³⁾ [mm]	265	270	355	440	535	
Increasing factors	Ψ_c	C25/30 [-]	1,05					
		C30/37 [-]	1,10					
		C35/45 [-]	1,15					
		C40/50 [-]	1,19					
		C45/55 [-]	1,22					
		C50/60 [-]	1,26					
Splitting failure		h_{min} [mm]	120	125	165	205	260	
Minimum member thickness		$s_{cr,sp}$ [mm]	360	360	440	540	700	
		$c_{cr,sp}$ [mm]	180	180	220	270	350	
Splitting failure		h_{min} [mm]	$\geq 2h_{ef}$					
	Minimum spacing		$s_{cr,sp}$ [mm]	240	240	300	360	460
			$c_{cr,sp}$ [mm]	120	120	150	180	230
Partial safety factor		$\gamma_{Mp} = \gamma_{Mc}^{1)}$ [-]	1,8 ²⁾					

¹⁾ In absence of other national regulations.

²⁾ The partial safety factor $\gamma_2 = 1,2$ is included.

³⁾ For the proof against combined pull-out and concrete cone failure according to Technical Report TR 029, Section 5.2.2.3 the values $N_{Rk,p}^0$, $c_{cr,Np}$, $s_{cr,Np}$ given in this table shall be used.

BTI Universal bonded anchor engineering UVT 300 Top

Design of Bonded Anchor acc. to TR 029
 Characteristic values to tension load
 Internal threaded anchor UVT Top I

Annex 9

of European
 Technical Approval

ETA- 09/0160

Tabelle 9: Design of Bonded Anchors acc. to TR 029
Characteristic values to shear loads
anchor rod UVT Top A

Anchor size			M6	M8	M10	M12	M16	M20	M24	M30	
Embedment depth	$h_{ef}^{2)}$	$h_{ef,min}$ [mm]	50	64	80	96	125	160	192	240	
		$h_{ef,max}$ [mm]	70	96	120	144	192	240	288	360	
Steel failure without lever arm											
characteristic resistance	$V_{Rk,s}$	property 5.8 [kN]	5,0	9,2	14,5	21,1	39,2	61,2	88,2	140,2	
		class 8.8 [kN]	8,0	14,6	23,2	33,7	62,8	98,0	141,2	224,4	
		A4-70 [kN]	7,0	12,8	20,3	29,5	54,8	85,7	123,4	196,2	
		C [kN]	7,0	12,8	20,3	29,5	54,8	85,7	123,4	196,2	
partial safety factor	$\gamma_{Ms}^{1)}$	property 5.8 [-]	1,25								
		class 8.8 [-]	1,25								
		A4-70 [-]	1,56								
		C [-]	1,25								
Steel failure with lever arm											
characteristic resistance	$M_{Rk,s}^0$	property 5.8 [Nm]	8	20	39	68	173	338	583	1169	
		class 8.8 [Nm]	12	30	60	105	266	519	896	1797	
		A4-70 [Nm]	11	26	52	92	233	454	785	1574	
		C [Nm]	11	26	52	92	233	454	785	1574	
partial safety factor	$\gamma_{Ms}^{1)}$	property 5.8 [-]	1,25								
		class 8.8 [-]	1,25								
		A4-70 [-]	1,56								
		C [-]	1,25								
Concrete pryout											
Faktor k in Equation (5.7) of Technical Report TR 029, Section 5.2.3.3			[-]								2,0
partial safety factor			$\gamma_{Mc}^{1)}$ [-]								1,5
Concrete edge failure											
effective length of anchor	l_f	h_{min} [mm]	50	64	80	96	125	160	192	240	
		h_{max} [mm]	70	96	120	144	192	240	288	360	
effective diameter of anchor		d [mm]	6	8	10	12	16	20	24	30	
partial safety factor			$\gamma_{Mc}^{1)}$ [-]								1,5

¹⁾ In absence of other national regulations.

²⁾ $h_{ef,min} \leq h_{ef} \leq h_{ef,max}$ is possible.

Table 10: Design of Bonded Anchor acc. to TR 029
Characteristic values to shear load
Internal threaded anchor UVT Top I

Anchor size		M8	M10	M12	M16	M20	
Embedment depth	h_{ef} [mm]	90	90	125	160	200	
Steel failure without lever arm UVT Top I (property class 5.8 and 8.8)							
characteristic resistance with screw	$V_{Rk,s}$	property 5.8 [kN]	9,5	15,1	21,9	40,7	63,6
		class 8.8 [kN]	14,6	23,2	33,7	62,7	91,1
Partial safety factor	$\gamma_{Ms}^{1)}$	property 5.8 [-]	1,25				
		class 8.8 [-]	1,25				1,5
Steel failure without lever arm UVT Top I (A4 / C)							
characteristic resistance with screw	$V_{Rk,s}$	A4-70 [kN]	12,8	20,3	29,5	54,8	85,7
		C [kN]	12,8	20,3	29,5	54,8	85,7
Partial safety factor	$\gamma_{Ms}^{1)}$	A4-70 [-]	1,56				
		C [-]	1,25				
Steel failure with lever arm UVT Top I (property class 5.8 and 8.8)							
characteristic resistance with screw	$M_{Rk,s}^0$	property 5.8 [Nm]	20	39	68	173	337
		class 8.8 [Nm]	30	60	105	266	519
Partial safety factor	$\gamma_{Ms}^{1)}$	property 5.8 [-]	1,25				
		class 8.8 [-]	1,25				
Steel failure with lever arm UVT Top I (A4 / C)							
characteristic resistance with screw	$M_{Rk,s}^0$	A4-70 [Nm]	26	52	92	232	454
		C [Nm]	26	52	92	232	454
Partial safety factor	$\gamma_{Ms}^{1)}$	A4-70 [-]	1,56				
		C [-]	1,25				
Concrete pryout							
Factor k in Equation (5.7) of Technical Report TR 029, Section 5.2.3.3		[-]	2,0				
Partial safety factor		$\gamma_{Mc}^{1)}$ [-]	1,5				
Concrete edge distance							
Effective length of anchor	l_f [mm]	90	90	125	160	200	
Effective diameter of anchor	d [mm]	12,5	16,5	18,5	22,5	28,5	
Partial safety factor		$\gamma_{Mc}^{1)}$ [-]	1,5				

¹⁾ In absence of other national regulations.

BTI Universal bonded anchor engineering UVT 300 Top

Design of Bonded Anchor acc. to TR 029
 Characteristic values to shear load
 Internal threaded anchor UVT Top I

Annex 11

of European
 technical approval

ETA- 09/0160

Table 11: Displacements of anchor rods UVT Top A due to tension and shear loads

Anchor size		M6	M8	M10	M12	M16	M20	M24	M30
Tension load									
Temperature range I -40°C / +80°C					Embedment depth $h_{ef} = 8 d^{1)}$				
Tension load in non-cracked concrete	N [kN]	2,5	7,7	11,0	15,8	25,5	37,9	51,7	76,3
Displacement	δ_{NO} [mm]	0,1	0,2	0,2	0,2	0,2	0,3	0,3	0,3
Displacement	δ_{Nco} [mm]	0,3	0,6	0,6	0,6	0,6	0,9	0,9	0,9
Temperature range II -40°C / +120°C					Embedment depth $h_{ef} = 8 d^{1)}$				
Tension load in non-cracked concrete	N [kN]	2,0	6,4	9,5	12,9	21,7	31,9	43,1	62,8
Displacement	δ_{NO} [mm]	0,1	0,15	0,15	0,15	0,15	0,25	0,25	0,25
Displacement	δ_{Nco} [mm]	0,3	0,45	0,45	0,45	0,45	0,75	0,75	0,75
Shear load									
Temperature range I -40°C / + 80°C and temperature range II -40°C / +120°C									
Shear load in non-cracked concrete (property class 5.8)	V [kN]	2,8	5,1	8,1	11,8	21,9	34,2	49,1	78,3
Displacement	δ_{VO} [mm]	0,7	0,9	1,2	1,4	2,0	2,4	2,6	3,7
Displacement	δ_{Vco} [mm]	1,2	1,4	1,7	2,1	2,9	3,7	4,1	5,6
Shear load in non-cracked concrete (property class 8.8)	V [kN]	4,6	7,0	11,1	16,2	30,1	47,0	67,7	107,7
Displacement	δ_{VO} [mm]	1,0	1,2	1,6	1,9	2,8	3,3	3,6	5,1
Displacement	δ_{Vco} [mm]	1,6	1,9	2,3	2,9	4,0	5,1	5,6	7,7
Shear load in non-cracked concrete (A4- 70)	V [kN]	3,2	5,9	9,3	13,5	25,2	39,3	56,4	89,9
Displacement	δ_{VO} [mm]	0,8	1,0	1,3	1,6	2,2	2,8	3,4	4,3
Displacement	δ_{Vco} [mm]	1,1	1,6	2,0	2,4	3,4	4,2	5,6	6,4
Shear load in non-cracked concrete (1.4529 or 1.4462)	V [kN]	4,0	7,3	11,6	16,9	31,4	49,0	70,4	112,2
Displacement	δ_{VO} [mm]	1,0	1,3	1,7	2,0	2,8	3,5	4,2	5,3
Displacement	δ_{Vco} [mm]	1,4	2,0	2,5	3,0	4,2	5,3	6,3	8,0

¹⁾ Values $8d \leq h_{ef} \leq 12d$ should be calculated:

$$\delta_{NO} = \delta_{NO1} \frac{h_{ef}}{8d} \quad \delta_{NO1} \text{ to } h_{ef} \ 8d$$

$$\delta_{Nco} = \delta_{Nco1} \frac{h_{ef}}{8d} \quad \delta_{Nco1} \text{ to } h_{ef} \ 8d$$

BTI Universal bonded anchor engineering UVT 300 Top

Displacements
anchor rods UVT Top A

Annex 12

of European
technical approval

ETA- 09/0160

Table 12: Displacements of Internal threaded anchors UVT Top I to tension load

Anchor size		M8	M10	M12	M16	M20
Temperature range I -40°C / +80°C						
Tension load in non-cracked concrete	N [kN]	11,9	13,8	19,8	29,8	69,4
Displacement	δ_{NO} [mm]	0,2	0,2	0,3	0,3	0,7
Displacement	δ_{Nco} [mm]	0,6	0,6	0,9	0,9	2,1
Temperature range II -40°C / +120°C						
Tension load in non-cracked concrete	N [kN]	9,9	11,9	15,8	23,8	37,7
Displacement	δ_{NO} [mm]	0,15	0,15	0,25	0,25	0,6
Displacement	δ_{Nco} [mm]	0,45	0,45	0,75	0,75	1,8

Displacements of Internal threaded anchors UVT Top I to shear load

The displacements of the internal threaded anchors UVT Top I to shear load are the same like anchor rods UVT Top A. See Table 11, Annex 12.

BTI Universal bonded anchor engineering UVT 300 Top

Displacements
Internal threaded anchors UVT Top I
Annex 13
of European
technical approval
ETA- 09/0160