

# Deutsches Institut für Bautechnik

Anstalt des öffentlichen Rechts

Kolonnenstr. 30 L  
10829 Berlin  
Germany

Tel.: +49(0)30 787 30 0  
Fax: +49(0)30 787 30 320  
E-mail: [dibt@dibt.de](mailto:dibt@dibt.de)  
Internet: [www.dibt.de](http://www.dibt.de)

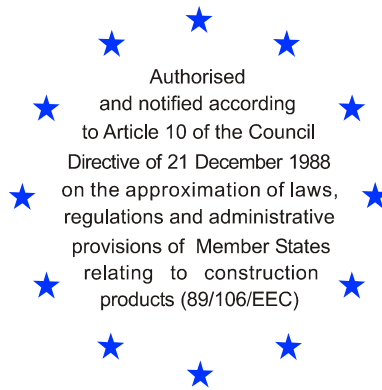

# DIBt

Mitglied der EOTA  
*Member of EOTA*

## European Technical Approval ETA-10/0136

English translation prepared by DIBt - Original version in German language

Handelsbezeichnung  
*Trade name*

VJ Technology Injektionssystem V420+ für  
Bewehrungsanschlüsse

*VJ Technology injection system V420+ for rebar connection*

Zulassungsinhaber  
*Holder of approval*

VJ Technology  
Brunswick Road; Cobbs Wood Ind. Estate  
ASHFORD KENT TN23 1EN .  
GROSSBRITANNIEN

Zulassungsgegenstand  
und Verwendungszweck  
*Generic type and use  
of construction product*

Nachträglich eingemörtelter Bewehrungsanschluss mit dem VJ  
Technology Injektionssystem V420+

*Post-installed rebar connection with VJ Technology injection System V420+*

Geltungsdauer: vom  
*Validity: from*  
bis  
*to*

7 May 2010

6 October 2014

Herstellwerk  
*Manufacturing plant*

VJ Technology, Plant1 Germany

Diese Zulassung umfasst  
*This Approval contains*

21 Seiten einschließlich 12 Anhänge  
*21 pages including 12 annexes*



Europäische Organisation für Technische Zulassungen  
European Organisation for Technical Approvals

## I LEGAL BASES AND GENERAL CONDITIONS

- 1 This European technical approval is issued by Deutsches Institut für Bautechnik in accordance with:
  - Council Directive 89/106/EEC of 21 December 1988 on the approximation of laws, regulations and administrative provisions of Member States relating to construction products<sup>1</sup>, modified by Council Directive 93/68/EEC<sup>2</sup> and Regulation (EC) N° 1882/2003 of the European Parliament and of the Council<sup>3</sup>;
  - Gesetz über das In-Verkehr-Bringen von und den freien Warenverkehr mit Bauprodukten zur Umsetzung der Richtlinie 89/106/EWG des Rates vom 21. Dezember 1988 zur Angleichung der Rechts- und Verwaltungsvorschriften der Mitgliedstaaten über Bauprodukte und anderer Rechtsakte der Europäischen Gemeinschaften (Bauproduktengesetz - BauPG) vom 28. April 1998<sup>4</sup>, as amended by law of 31 October 2006<sup>5</sup>;
  - Common Procedural Rules for Requesting, Preparing and the Granting of European technical approvals set out in the Annex to Commission Decision 94/23/EC<sup>6</sup>;
  - Guideline for European technical approval of "Metal anchors for use in concrete - Part 5: Bonded anchors", ETAG 001-05.
- 2 Deutsches Institut für Bautechnik is authorized to check whether the provisions of this European technical approval are met. Checking may take place in the manufacturing plant. Nevertheless, the responsibility for the conformity of the products to the European technical approval and for their fitness for the intended use remains with the holder of the European technical approval.
- 3 This European technical approval is not to be transferred to manufacturers or agents of manufacturers other than those indicated on page 1, or manufacturing plants other than those indicated on page 1 of this European technical approval.
- 4 This European technical approval may be withdrawn by Deutsches Institut für Bautechnik, in particular pursuant to information by the Commission according to Article 5(1) of Council Directive 89/106/EEC.
- 5 Reproduction of this European technical approval including transmission by electronic means shall be in full. However, partial reproduction can be made with the written consent of Deutsches Institut für Bautechnik. In this case partial reproduction has to be designated as such. Texts and drawings of advertising brochures shall not contradict or misuse the European technical approval.
- 6 The European technical approval is issued by the approval body in its official language. This version corresponds fully to the version circulated within EOTA. Translations into other languages have to be designated as such.

---

1 Official Journal of the European Communities L 40, 11 February 1989, p. 12

2 Official Journal of the European Communities L 220, 30 August 1993, p. 1

3 Official Journal of the European Union L 284, 31 October 2003, p. 25

4 *Bundesgesetzblatt Teil I 1998*, p. 812

5 *Bundesgesetzblatt Teil I 2006*, p.2407, 2416

6 Official Journal of the European Communities L 17, 20 January 1994, p. 34

## **II SPECIFIC CONDITIONS OF THE EUROPEAN TECHNICAL APPROVAL**

### **1 Definition of product and intended use**

#### **1.1 Definition of the construction product**

The subject of this approval is the post-installed connection, by anchoring or overlap connection joint, of reinforcing bars (rebar) in existing structures made of normal weight concrete, using the VJ Technology injection system V420+ in accordance with the regulations for reinforced concrete construction.

Reinforcing bars made of steel with a diameter  $\varnothing$  from 8 to 25 mm according to Annex 3 and the VJ Technology injection mortar V420+ used for rebar connections. The rebar is placed into a drilled hole filled with injection adhesive and is anchored via the bond between embedded element, injection mortar and concrete.

#### **1.2 Intended use**

The rebar connection may be used in normal weight concrete of a minimum grade of C12/15 and maximum grade C50/60 according to EN 206-1:2000. It may be used in non-carbonated concrete with allowable chloride content of 0.40 % (CL 0.40) related to the cement content according to EN 206-1.

Rebar connections with reinforcing bars may be used under predominantly static loads only.

The fire resistance of post-installed rebar connections is not covered by this European technical approval. Fatigue, dynamic or seismic loading of post-installed rebar connections are not covered by this European technical approval.

Rebar connections may only be carried out in a manner, which is also possible with cast-in straight reinforcing bars, e.g. those in the following applications (see Annex 2):

- an overlap joint with existing reinforcement in a building component (Figures 1 and 2),
- anchoring of the reinforcement at a slab or beam support, (e.g. according to Figure 3: end support of a slab, designed simply supported, as well as an appropriate general reinforcement for restraint forces),
- anchoring of reinforcement of building components stressed primarily in compression (Figure 4),
- anchoring of reinforcement to cover the envelope line of tensile force in the bending member (Figure 5).

The post-installed rebar connections may be used in the temperature range of  $-40\text{ °C}$  to  $+80\text{ °C}$  (max short term temperature  $+80\text{ °C}$  and max long term temperature  $+50\text{ °C}$ ).

This European technical approval covers anchoring in bore holes made with hammer drilling or compressed air drilling. The post-installed rebar connection may be installed in dry or wet concrete. It must not be installed in flooded holes.

The provisions made in this European technical approval are based on an assumed working life of the post-installed rebar connection of 50 years. The indications given on the working life cannot be interpreted as a guarantee given by the producer, but are to be regarded only as a means for choosing the right products in relation to the expected economically reasonable working life of the works.

## **2 Characteristics of the product and methods of verification**

### **2.1 Characteristics of the product**

The post-installed rebar connection corresponds to the drawings and provisions given in Annexes 1 to 3. The characteristic material values, dimensions and tolerances not indicated in Annexes 1 to 3 shall correspond to the respective values laid down in the technical documentation<sup>7</sup> of this European technical approval.

The two components of the injection adhesive are delivered in unmixed condition in coaxial cartridges of sizes 150 ml, 280 ml, 300 ml, 330 ml, 380 ml, 410 ml or 420 ml or in side-by-side cartridges of sizes 235 ml, 345 ml or 865 ml according to Annex 1. Each cartridge is marked with the identifying mark "V420+" with the processing notes, charge code, shelf life, hazard code, curing time and processing time (depending on temperature).

The rebar shall comply with the specifications given in Annex 3.

### **2.2 Methods of verification**

The assessment of fitness of the post-installed rebar connection for the intended use in relation to the requirements for mechanical resistance and stability and safety in use in the sense of the Essential Requirements 1 and 4 has been made in accordance with the "Guideline for European technical approval of Metal Anchors for Use in Concrete", Part 1 "Anchors in general" and Part 5 "Bonded anchors" and EOTA Technical Report TR 023 "Assessment of post-installed rebar connections"<sup>8</sup>.

In addition to the specific clauses relating to dangerous substances contained in this European technical approval, there may be other requirements applicable to the products falling within its scope (e.g. transposed European legislation and national laws, regulations and administrative provisions). In order to meet the provisions of the Construction Products Directive, these requirements need also to be complied with, when and where they apply.

## **3 Evaluation and attestation of conformity and CE marking**

### **3.1 System of attestation of conformity**

According to the Decision 96/582/EC of the European Commission<sup>9</sup> system 2(i) (referred to as System 1) of the attestation of conformity applies.

This system of attestation of conformity is defined as follows:

System 1: Certification of the conformity of the product by an approved certification body on the basis of:

(a) Tasks for the manufacturer:

- (1) factory production control;
- (2) further testing of samples taken at the factory by the manufacturer in accordance with a prescribed test plan;

---

<sup>7</sup> The technical documentation of this European technical approval is deposited at the Deutsches Institut für Bautechnik and, as far as relevant for the tasks of the approved bodies involved in the attestation of conformity procedure, is handed over to the approved bodies.

<sup>8</sup> The Technical Report TR 023 "Assessment of post-installed rebar connections" is published on EOTA website [www.EOTA.eu](http://www.EOTA.eu).

<sup>9</sup> Official Journal of the European Communities L 254 of 08.10.1996

- (b) Tasks for the approved body:
- (3) initial type-testing of the product;
  - (4) initial inspection of factory and of factory production control;
  - (5) continuous surveillance, assessment and approval of factory production control.

Note: Approved bodies are also referred to as "notified bodies".

## 3.2 Responsibilities

### 3.2.1 Tasks for the manufacturer

#### 3.2.1.1 Factory production control

The manufacturer shall exercise permanent internal control of production. All the elements, requirements and provisions adopted by the manufacturer shall be documented in a systematic manner in the form of written policies and procedures, including records of results performed. This production control system shall insure that the product is in conformity with this European technical approval.

The manufacturer may only use initial/raw/constituent materials stated in the technical documentation of this European technical approval.

The factory production control shall be in accordance with the control plan which is part of the technical documentation of this European technical approval. The control plan is laid down in the context of the factory production control system operated by the manufacturer and deposited with Deutsches Institut für Bautechnik.<sup>10</sup>

The results of factory production control shall be recorded and evaluated in accordance with the provisions of the control plan.

#### 3.2.1.2 Other tasks for the manufacturer

The manufacturer shall, on the basis of a contract, involve a body which is approved for the tasks referred to in section 3.1 in the field of anchors in order to undertake the actions laid down in section 3.2.2 For this purpose, the control plan referred to in sections 3.2.1.1 and 3.2.2 shall be handed over by the manufacturer to the approved body involved.

The manufacturer shall make a declaration of conformity, stating that the construction product is in conformity with the provisions of this European technical approval.

### 3.2.2 Tasks for the approved bodies

The approved body shall perform the

- initial type-testing of the product,
- initial inspection of factory and of factory production control,
- continuous surveillance, assessment and approval of factory production control,

in accordance with the provisions laid down in the control plan.

The approved body shall retain the essential points of its actions referred to above and state the results obtained and conclusions drawn in a written report.

The approved certification body involved by the manufacturer shall issue an EC certificate of conformity of the product stating the conformity with the provisions of this European technical approval.

---

<sup>10</sup> The control plan is a confidential part of the European technical approval and only handed over to the approved body involved in the procedure of attestation of conformity. See section 3.2.2.

In cases where the provisions of the European technical approval and its control plan are no longer fulfilled the certification body shall withdraw the certificate of conformity and inform Deutsches Institut für Bautechnik without delay.

### **3.3 CE marking**

The CE marking shall be affixed on each packaging of the injection mortar. The letters "CE" shall be followed by the identification number of the approved certification body, where relevant, and be accompanied by the following additional information:

- the name and address of the holder of the approval (legal entity responsible for the manufacture),
- the last two digits of the year in which the CE marking was affixed,
- the number of the EC certificate of conformity for the product,
- the number of the European technical approval,
- the number of the guideline for European technical approval.

## **4 Assumptions under which the fitness of the product for the intended use was favourably assessed**

### **4.1 Manufacturing**

The European technical approval is issued for the product on the basis of agreed data/information, deposited with Deutsches Institut für Bautechnik, which identifies the product that has been assessed and judged. Changes to the product or production process, which could result in this deposited data/information being incorrect, should be notified to Deutsches Institut für Bautechnik before the changes are introduced. Deutsches Institut für Bautechnik will decide whether or not such changes affect the approval and consequently the validity of the CE marking on the basis of the approval and if so whether further assessment or alterations to the approval shall be necessary.

### **4.2 Drafting**

Rebar connections must be designed in keeping with good engineering practice. Considering the loads to be anchored, design calculations and design drawings must be produced which can be checked. At least the following items must be stated in the design drawings:

- grade of concrete strength,
- diameter, drilling technique, concrete cover, spacing and embedment depth of the rebar,
- length for markings  $l_m$  and  $l_v$  on the injection extension according to Annex 8,
- use of a guide device (drilling aid) for drilling holes close to edges (if necessary),
- kind of preparation of the joint between building component being connected including the diameter and thickness of concrete layer that has to be removed.

### **4.3 Design**

#### **4.3.1 General**

The actual position of the reinforcement in the existing structure shall be determined on the basis of the construction documentation and taken into account when designing.

The design of post-installed rebar connections according to Annex 2 and determination of the internal section forces to be transferred in the construction joint shall be verified in accordance with EN 1992-1-1:2004. When ascertaining the tensile force in the rebar, allowance shall be made for the statically effective height of the bonded-in reinforcement.

The verification of the immediate local force transfer to the concrete has been provided.

The verification of the transfer of the loads to be anchored to the building component shall be provided.

#### 4.3.2 Determination of the basic anchorage length

The required basic anchorage length  $\ell_{b,rqd}$  shall be determined in accordance with EN 1992-1-1, Section 8.4.3:

$$\ell_{b,rqd} = (\emptyset / 4) \times (\sigma_{sd} / f_{bd})$$

with:  $\emptyset$  = diameter of the rebar

$\sigma_{sd}$  = calculated design stress of the rebar

$f_{bd}$  = design value of bond strength according to Annex 5, Table 4 in consideration of the coefficient related to the quality of bond conditions

#### 4.3.3 Determination of the design anchorage length

The required design anchorage length  $\ell_{bd}$  shall be determined in accordance with EN 1992-1-1, Section 8.4.4:

$$\ell_{bd} = \alpha_1 \alpha_2 \alpha_3 \alpha_4 \alpha_5 \ell_{b,rqd} \geq \ell_{b,min}$$

with:  $\ell_{b,rqd}$  = according to section 4.3.2

$\alpha_1$  = 1.0 for straight bars

$\alpha_2$  = 0.7...1.0 calculated acc. to EN 1992-1-1, Table 8.2

$\alpha_3$  = 1.0 because of no transverse reinforcement

$\alpha_4$  = 1.0 because of no welded transverse reinforcement

$\alpha_5$  = 0.7...1.0 for influence of transverse pressure acc. to EN 1992-1-1, Table 8.2

$\ell_{b,min}$  = minimum anchorage length acc. to EN 1992-1-1

= 1.5 max {0.3  $\ell_{b,rqd}$ ; 10  $\emptyset$ ; 100 mm} under tension

= 1.5 max {0.6  $\ell_{b,rqd}$ ; 10  $\emptyset$ ; 100 mm} under compression

The maximum permissible embedment depth is given in Annex 5 depending on diameter of the rebar.

#### 4.3.4 Overlap joints

The required design lap length  $\ell_0$  shall be determined in accordance with EN 1992-1-1, Section 8.7.3:

$$\ell_0 = \alpha_1 \alpha_2 \alpha_3 \alpha_5 \alpha_6 \ell_{b,rqd} \geq \ell_{0,min}$$

with:  $\ell_{b,rqd}$  = according to Section 4.3.2

$\alpha_1$  = 1.0 for straight bars

$\alpha_2$  = 0.7...1.0 calculated acc. to EN 1992-1-1, Table 8.2

$\alpha_3$  = 1.0 because of no transverse reinforcement

$\alpha_5$  = 0.7...1.0 for influence of transverse pressure acc. to EN 1992-1-1, Table 8.2

$\alpha_6$  = 1.0...1.5 for influence of percentage of lapped bars relative to the total cross-section area acc. to EN 1992-1-1, Table 8.3

$\ell_{0,min}$  = minimum lap length acc. to EN 1992-1-1

= 1.5 max {0.3  $\alpha_6 \ell_{b,rqd}$ ; 15  $\emptyset$ ; 200 mm}

The maximum permissible embedment depth is given in Annex 5 depending on diameter of the rebar.

#### 4.3.5 Embedment depth for overlap joints

For calculation of the effective embedment depth of overlap joints the concrete cover at end-face of bonded-in rebar  $c_1$  shall be considered (see Annex 4, Figure 7):

$$l_v \geq l_0 + c_1$$

with:  $l_0$  = required lap length acc. to Section 4.3.4 and to EN 1992-1-1

$c_1$  = concrete cover at end-face of bonded-in rebar (see also Annex 4)

If the clear distance between the overlapping rebar is greater than  $4 \varnothing$  the lap length shall be enlarged by the difference between the clear distance and  $4 \varnothing$ .

#### 4.3.6 Concrete cover

The concrete cover required for bonded-in rebar is shown in Annex 5, Table 2, in relation to the drilling method and the hole tolerance.

Furthermore the minimum concrete cover given in EN 1992-1-1, Section 4.4.1.2 shall be observed.

#### 4.3.7 Transverse reinforcement

The requirements of transverse reinforcement in the area of the post-installed rebar connection shall comply with EN 1992-1-1, Section 8.7.4.

#### 4.3.8 Connection joint

The transfer of shear forces between new concrete and existing structure shall be designed according to EN 1992-1-1. The joints for concreting must be roughened to at least such an extent that aggregate protrude.

In case of a carbonated surface of the existing concrete structure the carbonated layer shall be removed in the area of the post-installed rebar connection with a diameter of  $\varnothing + 60$  mm prior to the installation of the new rebar.

The depth of concrete to be removed shall correspond to at least the minimum concrete cover for the respective environmental conditions in accordance with EN 1992-1-1:2004.

The foregoing may be neglected if building components are new and not carbonated and if building components are in dry conditions.

### 4.4 Installation

The fitness for use of the post-installed rebar connection can only be assumed if the rebar is installed as follows:

- the installation of post-installed rebar shall be done only by suitable trained installer and under supervision on site; the conditions under which an installer may be considered as suitable trained and the conditions for supervision on site are up to the Member States in which the installation is done,
- use of the injection system only as supplied by the manufacturer without exchanging the components of the Injection system,
- installation in accordance with the manufacturer's specifications and drawings using the tools indicated in the technical documentation of this European technical approval,
- checks before rebar installation to ensure that the strength class of the concrete in which the post-installed rebar connection is to be placed is in the range given and is not lower than that of the concrete to which the characteristic loads apply,
- check of concrete being well compacted, e.g. without significant voids,
- check the position of the existing rebar (if the position of existing rebar is not known, it shall be determined using a rebar detector suitable for this purpose as well as on the basis of the construction documentation and then marked on the building component for the overlap joint),



- keeping the anchorage depth as specified in the design drawings,
- keeping of concrete cover and spacing as specified in the design drawings,
- positioning of the drill holes without damaging the reinforcement,
- in case of aborted drill hole the drill hole shall be filled with mortar,
- the post-installed rebar connection must not be installed in flooded holes,
- the drilling and cleaning of the hole and the installation shall be performed only with the equipment specified by the manufacturer according to the manufacturer's installation instructions (see Annexes 6 to 9), it shall be ensured that this equipment is available on site and it is used,
- during curing of the injection adhesive the temperature of the building component must not be less than 0 °C and must not exceed +40 °C; observing the curing time given in Annex 9.

## **5 Indications to the manufacturer**

### **5.1 Responsibility of the manufacturer**

It is in the responsibility of the manufacturer to ensure that the information on the specific conditions according to sections 1 and 2 including Annexes referred to as well as section 4 is given to those who are concerned. This information may be made by reproduction of the respective parts of the European technical approval. In addition all installation data shall be shown clearly on the package and/or on an enclosed instruction sheet, preferably using illustration(s).

The minimum data required are:

- drill bit diameter,
- diameter of rebar,
- admissible service temperature range,
- curing time of the injection mortar,
- Installation instructions including cleaning of the drill hole,
- reference to any special installation equipment needed,
- identification of the manufacturing batch,

All data shall be presented in a clear and explicit form.

### **5.2 Packaging, transport and storage**

The mortar cartridges shall be protected against sun radiation and shall be stored according to the manufacture's installation instructions in dry condition at temperatures of at least +5 °C to not more than +25 °C.

Mortar cartridges with expired shelf life must no longer be used.

Dipl.-Ing. Georg Feistel  
Head of Division Construction Engineering  
of Deutsches Institut für Bautechnik  
Berlin, 7 May 2010

*beglaubigt*  
Tempel

## Product description and intended use

Covered are only post-installed rebar connections in non-carbonated concrete (concrete C12/15 – C50/60 according to EN 206-1:2000) on the assumption only that the design of post-installed rebar connections is done in accordance to EN 1992-1-1:2004.

- Installation in dry or wet concrete, it must not be installed in flooded holes.
- Maximum short term temperature +80°C and max. long term temperature +50°C
- Reinforcing bar  $\varnothing$  8 mm to 25 mm with properties of class B and C according to Annex 3
- Maximum embedment depth see Annex 5, Table 3

### VJ Technology Injection system V420+:

**Dispensing tools:** see Annex 10, Table 8

**Brush:**



**SDS Plus Adapter:**

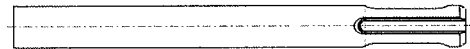

**Brush extension:**

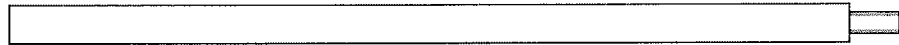

**Hand-pump:**

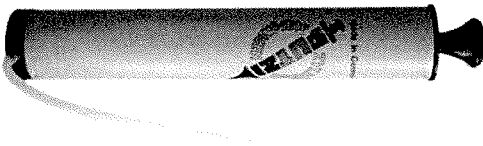

**Hand slide valve with air hose:**



### Injection mortar: V420+

**Type "coaxial"** : 150 ml, 280 ml, 300 ml, 330 ml, 380 ml, 410 ml and 420 ml cartridge



Imprint: V420+, processing notes, charge-code, shelf life, hazard-code, curing- and processing time (depending on the temperature), with as well as without travel scale

**Type "side-by-side"**:

235 ml, 345 ml and 865 ml cartridge



Imprint: V420+, processing notes, charge-code, shelf life, hazard-code, curing- and processing time (depending on the temperature), with as well as without travel scale

### Static Mixer

CRW 14

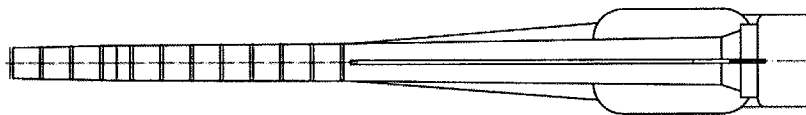

TAH 18W

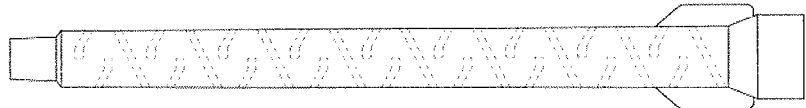

The static mixer TAH 18W is recommended for bore holes greater than 1000 mm.

**Piston plug and mixer extension**

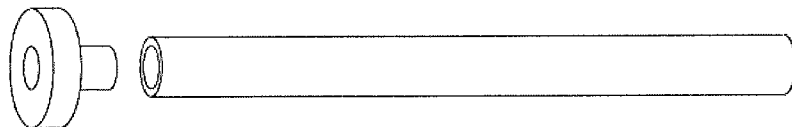

VJ Technology Injection system V420+ for rebar connection

Product description and Intended use

**Annex 1**

of European technical approval

**ETA-10/0136**

**Figure 1:** Overlapping joint for rebar connections of slabs and beams

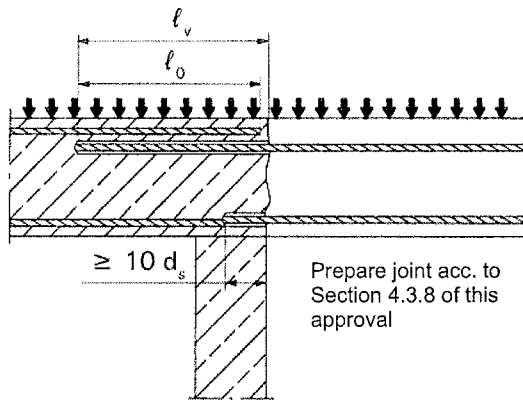

**Figure 2:** Overlapping joint at a foundation of a wall or column where the rebars are stressed in tension

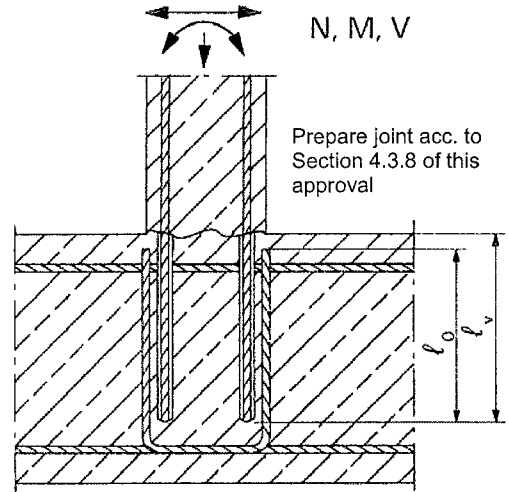

**Figure 3:** End anchoring of slabs or beams, designed as simply supported

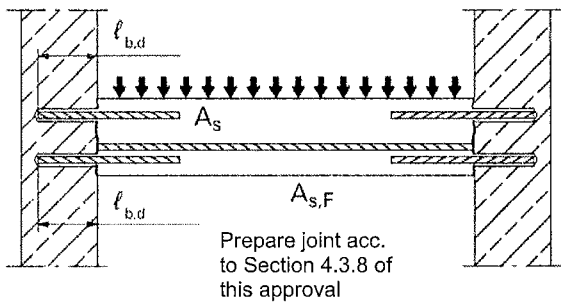

**Figure 4:** Rebar connection for components stressed primarily in compression. The rebars are stressed in compression

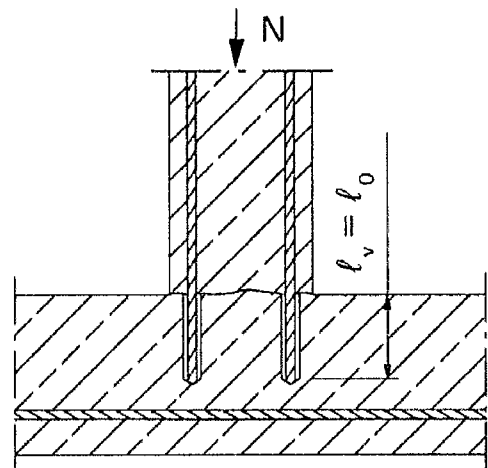

**Figure 5:** Anchoring of reinforcement to cover the line of acting tensile force

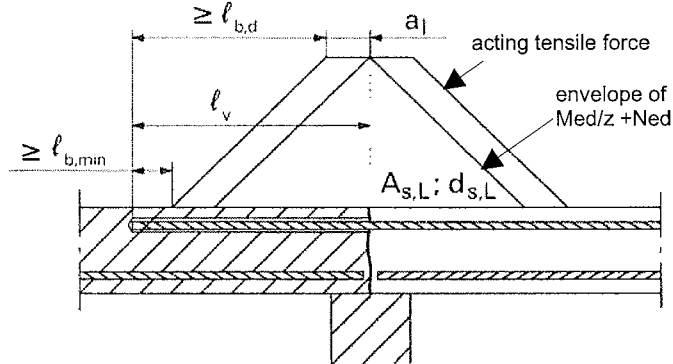

**Note to Figure 1 to 5:**

In the figures no transverse reinforcement is plotted, the transverse reinforcement as required by EN 1992-1-1 shall be present.

The shear transfer between old and new concrete shall be designed according to EN 1992-1-1

General rules for construction and design compare Annex 4.

VJ Technology Injection system V420+ for rebar connection

Examples of use for rebars

**Annex 2**

of European technical approval

**ETA-10/0136**

**Figure 6:** Properties of reinforcement

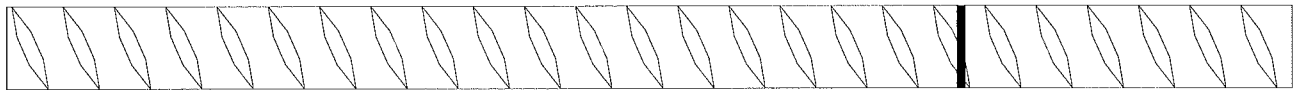

**Table 1a:** Abstract of EN 1992-1-1 Annex C, Table C.1, Properties of reinforcement

Product form		Bars and de-coiled rods	
Class		B	C
Characteristic yield strength $f_{yk}$ or $f_{0,2k}$ (N/mm <sup>2</sup> )		400 to 600	
Minimum value of $k = (f_t / f_y)_k$		≥ 1,08	≥ 1,15 < 1,35
Characteristic strain at maximum force $\epsilon_{uk}$ (%)		≥ 5,0	≥ 7,5
Bendability		Bend/Rebend test	
Maximum deviation from nominal mass (individual bar) (%)	Nominal bar size (mm)		
	≤ 8	± 6,0	
	> 8	± 4,5	

**Table 1b:** Abstract of EN 1992-1-1 Annex C, Table C.2N, Properties of reinforcement

Product form		Bars and de-coiled rods	
Class		B	C
Min. value of related rip area $f_{R,min}$	nominal diameter of the rebar (mm)		
	8 to 12	0,040	
	> 12	0,056	

Rip height of the bar shall be in the range  $0,05d \leq h \leq 0,07d$   
(d: Nominal diameter of the bar; h: Rip height of the bar)

VJ Technology Injection system V420+ for rebar connection	<b>Annex 3</b> of European technical approval  <b>ETA-10/0136</b>
Properties of reinforcement	

**Figure 7:** General design rules of construction for bended-in rebars

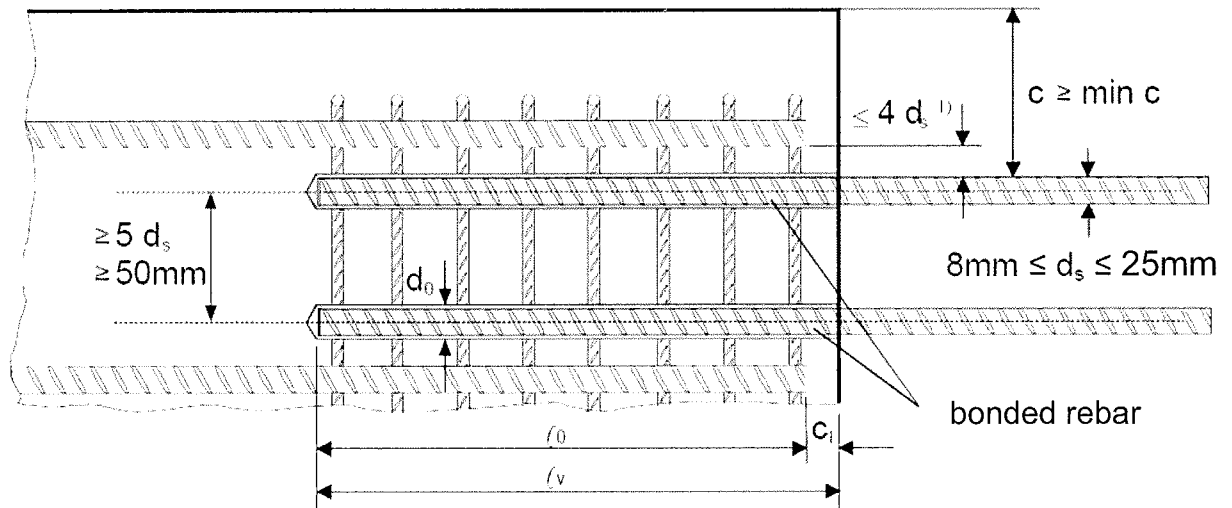

- 1) If the clear distance between lapped bars exceeds  $4d_s$ , then the lap length shall be increased by the difference between the clear bar distance and  $4d_s$ .

The following applies to Figure 7:

- $l_v$  or  $l_0$  are in accordance with section 4.3.2 of the approval
- The provision of sufficient transverse reinforcement according to section 4.3.2.6 of this approval

- c concrete cover post installed rebar  
 $c_1$  concrete cover at end-face of bond-in bar  
 min c minimum concrete cover according to Annex 5  
 $d_s$  diameter bonded-in bar  
 $l_0$  lap length  
 $l_v$  effective embedment depth  
 $d_0$  normal drill bit diameter, see Annex 7

VJ Technology Injection system V420+ for rebar connection

General design rules of construction for bended-in rebars

**Annex 4**  
 of European  
 technical approval  
**ETA-10/0136**

**Table 2:** Minimum concrete cover min c of bonded-in rebar depending of drilling method

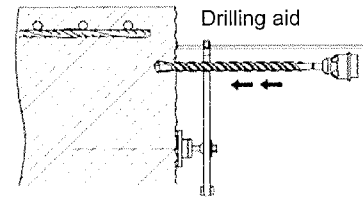

Drilling method	Rebar diameter	Without drilling aid	With drilling aid
Hammer drilling	< 25 mm	$30 \text{ mm} + 0,06 \cdot l_v \geq 2 d_s$	$30 \text{ mm} + 0,02 \cdot l_v \geq 2 d_s$
	= 25 mm	$40 \text{ mm} + 0,06 \cdot l_v \geq 2 d_s$	$40 \text{ mm} + 0,02 \cdot l_v \geq 2 d_s$
Compressed air drilling	< 25 mm	$50 \text{ mm} + 0,08 \cdot l_v$	$50 \text{ mm} + 0,02 \cdot l_v$
	= 25 mm	$60 \text{ mm} + 0,08 \cdot l_v$	$60 \text{ mm} + 0,02 \cdot l_v$

The minimum concrete cover must be observed according EN 1992-1-1:2004

**Table 3:** Minimum anchorage length<sup>1)</sup> and lap splice length for C20/25 and maximum installation length  $l_{max}$

Rebar		$l_{b,min}$ [mm]	$l_{o,min}$ [mm]	$l_{max}$ [mm]
$\varnothing d_s$	$f_{y,k}$ [N/mm <sup>2</sup> ]			
8 mm	500	170	300	1000
10 mm	500	213	300	1000
12 mm	500	255	300	1200
14 mm	500	298	315	1400
16 mm	500	340	360	1600
20 mm	500	425	450	2000
22 mm	500	468	495	2000
24 mm	500	510	540	2000
25 mm	500	532	563	2000

<sup>1)</sup> according to EN 1992-1-1:2004:  $l_{b,min}$  (8.6) and  $l_{o,min}$  (8.11) for good bond conditions and  $a_6 = 1,0$  with maximum yield stress for rebar BSt 500S and  $\gamma_M = 1,15$

**Table 4:** Design values of the ultimate bond resistance  $f_{bd}$ <sup>1)</sup> in N/mm<sup>2</sup> for all drilling methods for good conditions

Rebar - $\varnothing$	Concrete class								
	C12/15	C16/20	C20/25	C25/30	C30/37	C35/45	C40/50	C45/55	C50/60
8 to 25 mm	1,6	2,0	2,3	2,7	3,0	3,4	3,7	4,0	4,3

<sup>1)</sup> Tabulated values for  $f_{bd}$  are valid for good bond condition according to EN 1992-1-1:2004. For all other bond conditions multiply the values for  $f_{bd}$  by 0,7.

VJ Technology Injection system V420+ for rebar connection	<b>Annex 5</b> of European technical approval  <b>ETA-10/0136</b>
Installation parameters and design values of ultimate bond resistance $f_{bd}$	

### A) Bore hole drilling

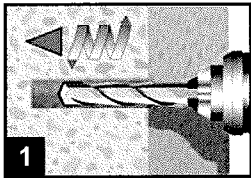

**1** Drill a hole into the base material to the size and embedment depth required by the selected reinforcing bar with carbide hammer drill (HD) or a compressed air drill (CD).

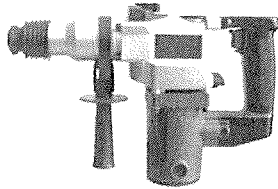

Hammer drill (HD)



Compressed air drill (CD)

Rebar - Ø $d_s$	Drill - Ø [mm]
8 mm	12
10 mm	14
12 mm	16
14 mm	18
16 mm	20
20 mm	25
22 mm	28
24 mm	32
25 mm	32

### B) Bore hole cleaning

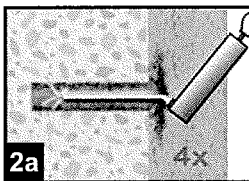

or

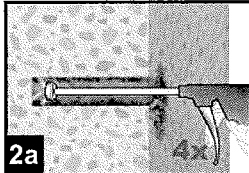

**2a** Starting from the bottom or back of the bore hole, blow the hole clean with compressed air or a hand pump a minimum of four times. If the bore hole ground is not reached an extension shall be used.

For bore holes deeper than 240 mm, compressed air (min. 6 bar) **must** be used.

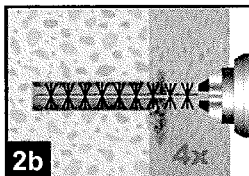

**2b** Check brush diameter (Table 5) and attach the brush to a drilling machine or a battery screwdriver. Brush the hole with an appropriate sized wire brush  $> d_{b,min}$  (Table 5) a minimum of four times. If the bore hole ground is not reached with the brush, a brush extension shall be used.

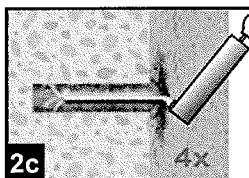

or

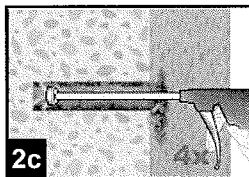

**2c** Finally blow the hole clean again with compressed air or a hand pump a minimum of four times. If the bore hole ground is not reached an extension shall be used.

For bore holes deeper than 240 mm, compressed air (min. 6 bar) **must** be used.

VJ Technology Injection system V420+ for rebar connection

Installation instruction

Bore hole drilling  
Bore hole cleaning

**Annex 6**  
of European  
technical approval

**ETA-10/0136**

**Table 5: Cleaning tools**

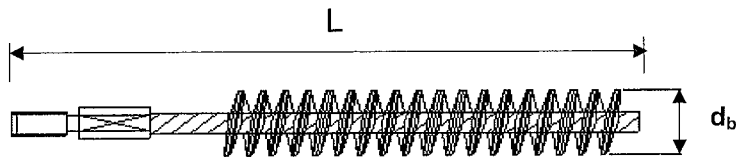

d <sub>s</sub> Rebar - Ø	d <sub>0</sub> Drill bit - Ø	d <sub>b</sub> Brush - Ø	d <sub>b,min</sub> min. Brush - Ø	L Total length
(mm)	(mm)	(mm)	(mm)	(mm)
8	12	14	12,5	170
10	14	16	14,5	200
12	16	18	16,5	200
14	18	20	18,5	300
16	20	22	20,5	300
20	25	27	25,5	300
22	28	30	28,5	300
24	32	34	32,5	300
25	32	34	32,5	300

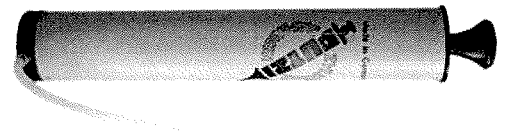

**Hand pump (volume 750 ml)**

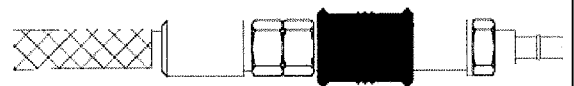

**Rec. compressed air tool hand slide valve (min 6 bar)**

**C) Preparation of bar and cartridge**

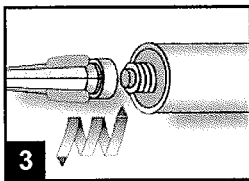

**3** Attach the supplied static-mixing nozzle to the cartridge and load the cartridge into the correct dispensing tool.  
For every working interruption longer than the recommended working time (Table 7) as well as for every new cartridges, a new static-mixer shall be used.

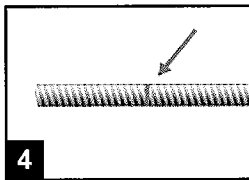

**4** Prior to inserting the reinforcing bar into the filled bore hole, the position of the embedment depth shall be marked (e.g. with tape) on the reinforcing bar and insert bar in empty hole to verify hole and depth  $l_v$ .  
The anchor should be free of dirt, grease, oil or other foreign material.

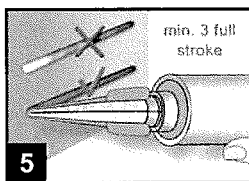

**5** Prior to dispensing into the anchor hole, squeeze out separately the mortar until it shows a consistent grey colour, but a minimum of three full strokes, and discard non-uniformly mixed adhesive components.

VJ Technology Injection system V420+ for rebar connection	<b>Annex 7</b> of European technical approval  <b>ETA-10/0136</b>
Installation instruction	
Cleaning tools Preparation of bar and cartridge	



### D) Filling the bore hole

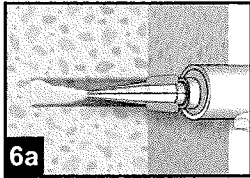

**6** Starting from the bottom or back of the cleaned anchor hole fill the hole up to approximately two-thirds with adhesive. Slowly withdraw the static mixing nozzle as the hole fills to avoid creating air pockets. For embedment larger than 190 mm an extension nozzle shall be used.

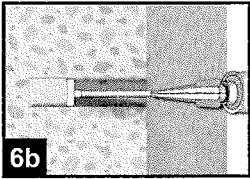

For overhead and horizontal installation and bore holes deeper than 240 mm a piston plug and the appropriate mixer extension must be used.

Observe the gel-/ working times given in Table 4.

**Table 6:** Piston plugs, max anchorage depth and mixer extension

Bar size	Drill bit - Ø		Piston plug	Cartridge:					
	HD	PD		coaxial (all), side-by-side (235, 345 ml)		side-by-side (865 ml)			
				Hand or battery tool	Pneumatic tool	Pneumatic tool			
(mm)	(mm)	No.	$l_{max}$	Mixer extension	$l_{max}$	Mixer extension	$l_{max}$	Mixer extension	
8	12	-	-	70	VL 10/0,75	80	VL 10/0,75	80	VL 10/0,75
10	14	-	#14			100		100	
12	16		#16			120		120	
14	18		#18			140		140	
16	20		#20			160		160	
20	25	26	#25	50	VL 16/1,8	70	200	200	
22	28		#28			50		50	
24	32		#32			50		50	
25	32		#32			50		50	

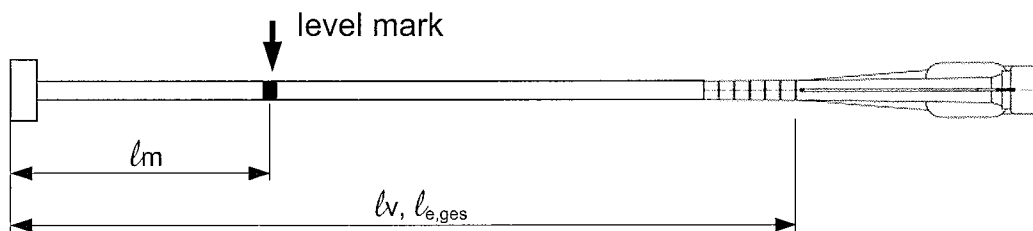

Injection tool must be marked by mortar level mark  $l_m$  and anchorage depth  $l_v$  resp.  $l_{e,ges}$  with tape or marker.

Quick estimation:  $l_m = 1/3 \cdot l_v$

Continue injection until the mortar level mark  $l_m$  becomes visible.

Optimum mortar volume:  $l_m = l_v$  resp.  $l_{e,ges} \cdot \left( 1,2 \cdot \frac{d_s^2}{d_0^2} - 0,2 \right)$  [mm]

VJ Technology Injection system V420+ for rebar connection

Installation instruction

Filling the bore hole

**Annex 8**

of European technical approval

**ETA-10/0136**

## E) Inserting the rebar

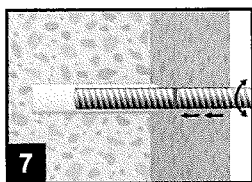

7 Push the reinforcing bar into the anchor hole while turning slightly to ensure positive distribution of the adhesive until the embedment depth is reached.

The anchor should be free of dirt, grease, oil or other foreign material.

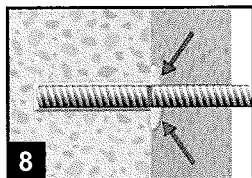

8 Be sure that the bar is inserted in the bore hole until the embedment mark is at the concrete surface and that excess mortar is visible at the top of the hole. If these requirements are not maintained, the application has to be renewed.

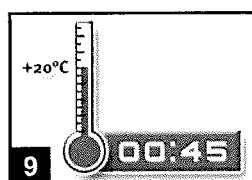

9 Observe gelling time  $t_{gel}$ . Attend that the gelling time can vary according to the base material temperature (see Table 7). It is not allowed to move the bar after gelling time  $t_{gel}$  has elapsed.

Allow the adhesive to cure to the specified time prior to applying any load. Do not move or load the bar until it is fully cured (attend Table 7). After full curing time  $t_{cure}$  has elapsed, the add-on part can be installed.

**Table 7:** Base material temperature, gelling time and curing time

Concrete temperature	Gelling- / working time <sup>1)</sup>	Minimum curing time in dry concrete <sup>4)</sup>
	$t_{gel}$	$t_{cure,dry}$
0°C to +4°C	45 <sup>2)</sup> min	7 h
+5°C to +9°C	25 <sup>2)</sup> min	2 h
+10°C to +19°C	15 <sup>2)</sup> min	80 min
+20°C to +24°C	6 <sup>2)</sup> min	45 min
+25°C to +29°C	4 <sup>2)</sup> min	25 min
+30°C to +40°C	2,5 <sup>3)</sup> min	15 min

1)  $t_{gel}$ : maximum time from starting of mortar injection to completing of rebar setting.

2) Cartridge temperature **must** be between +5°C and +25°C

3) Cartridge temperature **must** be below +20°C

4) In wet concrete the curing time  $t_{cure,dry}$  has to be doubled up

VJ Technology Injection system V420+ for rebar connection

Installation instruction

Inserting rebar





Gelling time and curing time

**Annex 9**

of European technical approval

**ETA-10/0136**

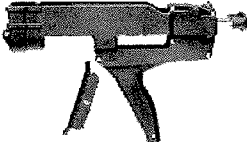
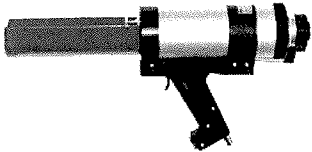
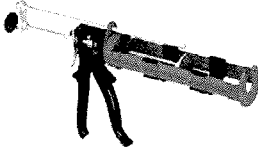
**Table 8:** Dispensing tools

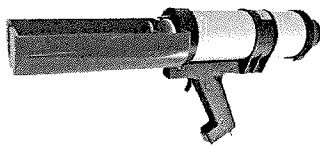
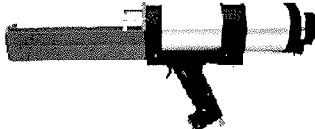
Cartridge type/size	Hand tool		Pneumatic tool
Coaxial cartridges 150, 280, 300, 330 ml	 Type H 297 or H244C		 Type TS 492 X
Coaxial cartridges 380, 410, 420 ml	 Type CCM 380/10	 Type H 285 or H244C	 Type TS 485 LX
Side-by-side cartridges 235, 345 ml	 Type CBM 330A	 Type H 260	 Type TS 477 LX
Side-by-side cartridge 865 ml	-	-	 Type TS 498X

All cartridges, except the 865ml, could also be extruded by a battery tool.

VJ Technology Injection system V420+ for rebar connection	<b>Annex 10</b> of European technical approval <b>ETA-10/0136</b>
Dispensing tools	

**Table 9:** Values for pre-calculation of anchoring.Example for: C20/25; good bond condition; Rebar yield strength 500 N/mm<sup>2</sup>; for all drilling procedures

Bar-Ø d <sub>s</sub>	α <sub>1</sub> =α <sub>2</sub> =α <sub>3</sub> =α <sub>4</sub> =α <sub>5</sub> =1,0			α <sub>2</sub> or α <sub>5</sub> =0,7 α <sub>1</sub> =α <sub>3</sub> =α <sub>4</sub> =1,0		
	Anchorage length l <sub>bd</sub>	Design value N <sub>Rd</sub>	Mortar volume	Anchorage length l <sub>bd</sub>	Design value N <sub>Rd</sub>	Mortar volume
[mm]	[mm]	[kN]	[ml]	[mm]	[kN]	[ml]
8	170*	9,83	13	170*	14,04	13
	220	12,72	17	190	15,69	14
	270	15,61	20	220	18,17	17
	378	21,85	29	265	21,85	20
10	213*	15,39	19	213*	21,99	19
	280	20,23	25	240	24,77	22
	340	24,57	31	270	27,87	24
	410	29,63	37	300	30,97	27
	473	34,15	43	331	34,15	30
12	255*	22,11	27	255*	31,59	27
	330	28,61	35	290	35,92	31
	410	35,55	43	330	40,88	35
	490	42,49	52	360	44,59	38
	567	49,17	60	397	49,17	42
14	298*	30,15	36	298*	43,06	36
	390	39,45	47	340	49,13	41
	480	48,56	58	380	54,92	46
	570	57,66	69	420	60,70	51
	662	66,93	80	463	66,93	56
16	340*	39,31	46	340*	56,15	46
	440	50,87	60	390	64,41	53
	550	63,59	75	430	71,02	58
	650	75,15	88	480	79,28	65
	756	87,42	103	529	87,42	72
20	425*	61,42	90	425*	87,74	90
	560	80,93	119	480	99,09	102
	690	99,71	146	540	111,48	115
	820	118,50	174	600	123,87	127
	945	136,59	200	662	136,59	140
22	468*	74,40	132	468*	106,28	132
	610	96,97	172	530	120,36	150
	750	119,22	212	600	136,26	170
	900	143,07	254	660	149,88	187
	1040	165,28	294	728	165,28	206
24	510*	88,44	215	510*	126,35	215
	670	116,19	283	580	143,69	245
	820	142,20	346	650	161,03	274
	980	169,95	414	720	178,37	304
	1134	196,69	479	794	196,69	335
25	532*	96,10	200	532*	137,29	200
	690	124,64	259	610	157,42	229
	860	155,35	323	680	175,48	256
	1020	184,25	384	750	193,54	282
	1181	213,42	444	827	213,42	311

\* minimum anchorage length, see also Annex 5 Table 3

The design value is valid for "good bond conditions" according to EN 1992-1-1. All other condition: multiply value by 0,7.

Mortar volume based on equation:  $V = 1,2 \cdot (d_0^2 - d_s^2) \cdot \pi \cdot l_b / 4$ 

VJ Technology Injection system V420+ for rebar connection

Values for pre-calculation of anchoring.  
 Example for:  
 C20/25; good bond condition; Rebar yield strength 500 N/mm<sup>2</sup>; for  
 all drilling procedures

**Annex 11**of European  
technical approval**ETA-10/0136**

**Table 10:** Values for pre-calculation of overlap joints.  
Example for: C20/25; good bond condition; Rebar yield strength 500 N/mm<sup>2</sup>; for all drilling procedures

Bar-Ø d <sub>s</sub>	α <sub>1</sub> =α <sub>2</sub> =α <sub>3</sub> =α <sub>4</sub> =α <sub>5</sub> =1,0			α <sub>2</sub> or α <sub>5</sub> =0,7 α <sub>1</sub> =α <sub>3</sub> =α <sub>4</sub> =1,0		
	Lap length l <sub>0</sub>	Design value N <sub>Rd</sub>	Mortar volume	Lap length l <sub>0</sub>	Design value N <sub>Rd</sub>	Mortar volume
[mm]	[mm]	[kN]	[ml]	[mm]	[kN]	[ml]
8	300*	9,83	23	300*	14,04	23
	320	12,72	24	290	15,69	22
	340	15,61	26	280	18,17	21
	378	21,85	29	265	21,85	20
10	300*	15,39	27	300*	21,99	27
	340	20,23	31	310	24,77	28
	390	24,57	35	320	27,87	29
	430	29,63	39	320	30,97	29
12	473*	34,15	43	331*	34,15	30
	300*	22,11	32	300*	31,59	32
	370	28,61	39	320	35,92	34
	430	35,55	45	350	40,88	37
	500	42,49	53	370	44,59	39
14	567	49,17	60	397	49,17	42
	315*	30,15	38	315*	43,06	38
	400	39,45	48	350	49,13	42
	490	48,56	59	390	54,92	47
	570	57,66	69	430	60,70	52
16	662	66,93	80	463	66,93	56
	360*	39,31	49	360*	56,15	49
	460	50,87	62	400	64,41	54
	560	63,59	76	440	71,02	60
	660	75,15	90	490	79,28	67
20	756	87,42	103	529	87,42	72
	450*	61,42	95	450*	87,74	95
	570	80,93	121	500	99,09	106
	700	99,71	148	560	111,48	119
	820	118,50	174	610	123,87	129
22	945	136,59	200	662	136,59	140
	495*	74,40	140	495*	106,28	140
	630	96,97	178	550	120,36	156
	770	119,22	218	610	136,26	172
	900	143,07	254	670	149,88	189
24	1040	165,28	294	728	165,28	206
	540*	88,44	228	540*	126,35	228
	690	116,19	291	600	143,69	253
	840	142,20	355	670	161,03	283
	990	169,95	418	730	178,37	308
25	1134	196,69	479	794	196,69	335
	563*	96,10	212	563*	137,29	212
	720	124,64	271	630	157,42	237
	870	155,35	327	700	175,48	263
	1030	184,25	387	760	193,54	286
	1181	213,42	444	827	213,42	311

\* minimum anchorage length, see also Annex 5 Table 3

The design value is valid for "good bond conditions" according to EN 1992-1-1. All other condition: multiply value by 0,7.

Mortar volume based on equation:  $V = 1,2 \cdot (d_0^2 - d_s^2) \cdot \pi \cdot l_b / 4$

VJ Technology Injection system V420+ for rebar connection

Values for pre-calculation of overlap joints.

Example for:

C20/25; good bond condition; Rebar yield strength 500 N/mm<sup>2</sup>; for all drilling procedures

**Annex 12**

of European technical approval

**ETA-10/0136**