

European Technical Approval ETA-05/0255

English translation prepared by DIBt - Original version in German language

Handelsbezeichnung <i>Trade name</i>	Hilti HVU mit HAS(-E)(-F) und HIS-N <i>Hilti HVU with HAS(-E)(-F) and HIS-N</i>	
Zulassungsinhaber <i>Holder of approval</i>	Hilti Aktiengesellschaft Business Unit Anchors 9494 Schaan FÜRSTENTUM LIECHTENSTEIN	
Zulassungsgegenstand und Verwendungszweck <i>Generic type and use of construction product</i>	Verbunddübel mit Ankerstange oder Innengewindehülse aus verzinktem Stahl in den Größen M8, M10, M12, M16, M20, M24, M27 und M30 zur Verankerung im ungerissenen Beton <i>Bonded anchor with anchor rod or internal sleeve made of galvanised steel of sizes M8, M10, M12, M16, M20, M24, M27 and M30 for use in non-cracked concrete</i>	
Geltungsdauer: <i>Validity:</i>	vom <i>from</i>	1 March 2010
	bis <i>to</i>	20 January 2011
verlängert <i>extended</i>	vom <i>from</i>	20 January 2011
	bis <i>to</i>	20 January 2016
Herstellwerk <i>Manufacturing plant</i>	Hilti Werke	

Diese Zulassung umfasst
This Approval contains

19 Seiten einschließlich 11 Anhänge
19 pages including 11 annexes

I LEGAL BASES AND GENERAL CONDITIONS

- 1 This European technical approval is issued by Deutsches Institut für Bautechnik in accordance with:
 - Council Directive 89/106/EEC of 21 December 1988 on the approximation of laws, regulations and administrative provisions of Member States relating to construction products¹, modified by Council Directive 93/68/EEC² and Regulation (EC) N° 1882/2003 of the European Parliament and of the Council³;
 - Gesetz über das In-Verkehr-Bringen von und den freien Warenverkehr mit Bauprodukten zur Umsetzung der Richtlinie 89/106/EWG des Rates vom 21. Dezember 1988 zur Angleichung der Rechts- und Verwaltungsvorschriften der Mitgliedstaaten über Bauprodukte und anderer Rechtsakte der Europäischen Gemeinschaften (Bauproduktengesetz - BauPG) vom 28. April 1998⁴, as amended by law of 31 October 2006⁵;
 - Common Procedural Rules for Requesting, Preparing and the Granting of European technical approvals set out in the Annex to Commission Decision 94/23/EC⁶;
 - Guideline for European technical approval of "Metal anchors for use in concrete - Part 5: Bonded anchors", ETAG 001-05.
- 2 Deutsches Institut für Bautechnik is authorized to check whether the provisions of this European technical approval are met. Checking may take place in the manufacturing plant. Nevertheless, the responsibility for the conformity of the products to the European technical approval and for their fitness for the intended use remains with the holder of the European technical approval.
- 3 This European technical approval is not to be transferred to manufacturers or agents of manufacturers other than those indicated on page 1, or manufacturing plants other than those indicated on page 1 of this European technical approval.
- 4 This European technical approval may be withdrawn by Deutsches Institut für Bautechnik, in particular pursuant to information by the Commission according to Article 5(1) of Council Directive 89/106/EEC.
- 5 Reproduction of this European technical approval including transmission by electronic means shall be in full. However, partial reproduction can be made with the written consent of Deutsches Institut für Bautechnik. In this case partial reproduction has to be designated as such. Texts and drawings of advertising brochures shall not contradict or misuse the European technical approval.
- 6 The European technical approval is issued by the approval body in its official language. This version corresponds fully to the version circulated within EOTA. Translations into other languages have to be designated as such.

¹ Official Journal of the European Communities L 40, 11 February 1989, p. 12

² Official Journal of the European Communities L 220, 30 August 1993, p. 1

³ Official Journal of the European Union L 284, 31 October 2003, p. 25

⁴ *Bundesgesetzblatt Teil I 1998*, p. 812

⁵ *Bundesgesetzblatt Teil I 2006*, p. 2407, 2416

⁶ Official Journal of the European Communities L 17, 20 January 1994, p. 34

II SPECIFIC CONDITIONS OF THE EUROPEAN TECHNICAL APPROVAL

1 Definition of the construction and intended use

1.1 Definition of the product

The Hilti HVU with HAS(-E)(-F) and HIS-N is a bonded anchor consisting of a foil capsule Hilti HVU and an anchor rod HAS(-E)(-F) with hexagon nut and washer of sizes M8, M10, M12, M16, M20, M24, M27 and M30 or an internal sleeve HIS-N of sizes M8, M10, M12, M16 and M20 respectively. The anchor rod HAS(-E) (including nut and washer) respectively are made of galvanised steel. The anchor rod HAS(-E)-F is made of hot dipped galvanised steel. The foil capsule is placed in the hole and the anchor rod is driven by machine with simultaneous hammering and turning. The anchor rod is anchored via the bond between anchor rod, chemical mortar and concrete

An illustration of the product and intended use is given in Annex 1.

1.2 Intended use

The anchor is intended to be used for anchorages for which requirements for mechanical resistance and stability and safety in use in the sense of the Essential Requirements 1 and 4 of Council Directive 89/106 EEC shall be fulfilled and failure of anchorages made with these products would cause risk to human life and/or lead to considerable economic consequences. Safety in case of fire (Essential Requirement 2) is not covered in this European technical approval. The anchor is to be used only for anchorages subject to static or quasi-static loading in reinforced or unreinforced normal weight concrete of strength classes C20/25 at minimum and C50/60 at most according to EN 206:2000-12.

The anchor may be anchored in non-cracked concrete only.

It may only be used in structures subject to dry internal conditions.

It may be installed in dry or wet concrete; it must not be installed in flooded holes.

The anchor may be used in the following temperature ranges:

Temperature range 1:	-40 °C to +40 °C	(max long term temperature +24 °C and max short term temperature +40 °C)
Temperature range 2:	-40 °C to +80 °C	(max long term temperature +50 °C and max short term temperature +80 °C)
Temperature range 3:	-40 °C to +120 °C	(max long term temperature +72 °C and max short term temperature +120 °C)

The provisions made in this European technical approval are based on an assumed working life of the anchor of 50 years. The indications given on the working life cannot be interpreted as a guarantee given by the producer, but are to be regarded only as a means for choosing the right products in relation to the expected economically reasonable working life of the works.

2 Characteristics of product and methods of verification

2.1 Characteristics of product

The anchor corresponds to the drawings and provisions given in Annexes 1 to 3. The characteristic material values, dimensions and tolerances of the anchor not indicated in Annexes 1 to 3 shall correspond to the respective values laid down in the technical documentation⁷ of this European technical approval.

The characteristic values for the design of anchorages are given in Annexes 5 to 11.

Each foil capsule shall be marked with the imprint HVU, the anchor size and the expiry date in accordance with Annex 1. Each anchor rod shall be marked with the identifying mark of the producer, marking for the material and with a marking of the effective anchorage depth in accordance with Annex 3. Each internal sleeve shall be marked with the identifying mark of the producer and "HIS-N" in accordance with Annex 3.

2.2 Methods of verification

The assessment of fitness of the anchor for the intended use in relation to the requirements for mechanical resistance and stability and safety in use in the sense of the Essential Requirements 1 and 4 has been made in accordance with the "Guideline for European technical approval of Metal Anchors for Use in Concrete", Part 1 "Anchors in general" and Part 5 "Bonded anchors", on the basis of Option 7.

In addition to the specific clauses relating to dangerous substances contained in this European technical approval, there may be other requirements applicable to the products falling within its scope (e.g. transposed European legislation and national laws, regulations and administrative provisions). In order to meet the provisions of the Construction Products Directive, these requirements need also to be complied with, when and where they apply.

3 Evaluation and attestation of conformity and CE marking

3.1 System of attestation of conformity

According to the decision 96/582/EG of the European Commission⁸ the system 2(i) (referred to as System 1) of attestation of conformity applies.

This system of attestation of conformity is defined as follows:

System 1: Certification of the conformity of the product by an approved certification body on the basis of:

- (a) Tasks for the manufacturer:
 - (1) factory production control;
 - (2) further testing of samples taken at the factory by the manufacturer in accordance with a prescribed control plan;
- (b) Tasks for the approved body:
 - (3) initial type-testing of the product;
 - (4) initial inspection of factory and of factory production control;
 - (5) continuous surveillance, assessment and approval of factory production control.

Note: Approved bodies are also referred to as "notified bodies".

⁷ The technical documentation of this European technical approval is deposited at the Deutsches Institut für Bautechnik and, as far as relevant for the tasks of the approved bodies involved in the attestation of conformity procedure, is handed over to the approved bodies.

⁸ Official Journal of the European Communities L 254 of 08.10.1996

3.2 Responsibilities

3.2.1 Tasks of the manufacturer

3.2.1.1 Factory production control

The manufacturer shall exercise permanent internal control of production. All the elements, requirements and provisions adopted by the manufacturer shall be documented in a systematic manner in the form of written policies and procedures, including records of results performed. This production control system shall insure that the product is in conformity with this European technical approval.

The manufacturer may only use initial / raw / constituent materials stated in the technical documentation of this European technical approval.

The factory production control shall be in accordance with the control plan which is part of the technical documentation of this European technical approval. The control plan is laid down in the context of the factory production control system operated by the manufacturer and deposited at Deutsches Institut für Bautechnik.⁹

The results of factory production control shall be recorded and evaluated in accordance with the provisions of the control plan.

3.2.1.2 Other tasks of manufacturer

The manufacturer shall, on the basis of a contract, involve a body which is approved for the tasks referred to in section 3.1 in the field of anchors in order to undertake the actions laid down in section 3.2.2. For this purpose, the control plan referred to in sections 3.2.1.1 and 3.2.2 shall be handed over by the manufacturer to the approved body involved.

The manufacturer shall make a declaration of conformity, stating that the construction product is in conformity with the provisions of this European technical approval.

3.2.2 Tasks of approved bodies

The approved body shall perform the following tasks in accordance with the provisions laid down in the control plan:

- initial type-testing of the product,
- initial inspection of factory and of factory production control,
- continuous surveillance, assessment and approval of factory production control.

The approved body shall retain the essential points of its actions referred to above and state the results obtained and conclusions drawn in a written report.

The approved certification body involved by the manufacturer shall issue an EC certificate of conformity of the product stating the conformity with the provisions of this European technical approval.

In cases where the provisions of the European technical approval and its control plan are no longer fulfilled the certification body shall withdraw the certificate of conformity and inform Deutsches Institut für Bautechnik without delay.

3.3 CE marking

The CE marking shall be affixed on each packaging of anchors. The letters "CE" shall be followed by the identification number of the approved certification body, where relevant, and be accompanied by the following additional information:

- the name and address of the producer (legal entity responsible for the manufacturer),
- the last two digits of the year in which the CE marking was affixed,
- the number of the EC certificate of conformity for the product,

⁹ The control plan is a confidential part of the European technical approval and only handed over to the approved body involved in the procedure of attestation of conformity. See section 3.2.2.

- the number of the European technical approval,
- the number of the guideline for European technical approval,
- use category (ETAG 001-1, Option 7),
- size.

4 Assumptions under which the fitness of the product for the intended use was favourably assessed

4.1 Manufacturing

The anchor is manufactured in accordance with the provisions of the European technical approval using the automated manufacturing process as identified in the inspection of the plant by the Deutsches Institut für Bautechnik and the approved body and laid down in the technical documentation.

The European technical approval is issued for the product on the basis of agreed data/information, deposited with Deutsches Institut für Bautechnik, which identifies the product that has been assessed and judged. Changes to the product or production process, which could result in this deposited data/information being incorrect, should be notified to Deutsches Institut für Bautechnik before the changes are introduced. Deutsches Institut für Bautechnik will decide whether or not such changes affect the European technical approval and consequently the validity of the CE marking on the basis of the European technical approval and if so whether further assessment or alterations to the European technical approval shall be necessary.

4.2 Design of anchorages

The fitness of the anchor for the intended use is given under the following conditions:

The anchorages are designed in accordance with the "Guideline for European technical approval of Metal Anchors for Use in Concrete", Annex C, Method A, for bonded anchors under the responsibility of an engineer experienced in anchorages and concrete work.

For the verifications given below according to Annex C the following shall be observed:

- For the verification 'concrete cone failure' (clause 5.2.2.4, Annex C of the Guideline) $N_{Rk,c}$ shall be determined according to (1) and (2): The smaller of the values according to (1) and (2) is decisive.

(1) $N_{Rk,c}$ according to equation (5.2), Annex C of the Guideline

$$\text{where: } N_{Rk,c}^0 \quad \text{according to Annex 6 or 8,}$$

$$S_{cr,N} \quad \text{according to Annex 6 or 8,}$$

$$C_{cr,N} \quad \text{according to Annex 6 or 8,}$$

$$\Psi_{ucr,N} = 1,0$$

In special cases according to clause 5.2.2.4 g, Annex C of the Guideline the method given there is valid. However, the value $N_{Rk,c}^0$ shall be calculated according to the following equation:

$$N_{Rk,c}^0 = N_{Rk,c}^0 \text{ (Annex 6 or 8)} \times \frac{h'_{ef}}{h_{ef}}$$

(2) $N_{Rk,c}$ according to equation (5.2), Annex C of the Guideline

$$\text{where: } N_{Rk,c}^0 = 0,75 \times 15,5 \times h_{ef}^{1,5} \times f_{ck,cube}^{0,5}$$

$$S_{cr,N} = 3 h_{ef}$$

$$C_{cr,N} = 1,5 h_{ef}$$

$$\Psi_{ucr,N} = 1,0$$

For the verification 'splitting failure due to loading' (clause 5.2.2.6, Annex C of the Guideline) $N_{Rk,sp}$ shall be determined according to (3).

(3) $N_{Rk,sp}$ according to equation (5.3), Annex C of the Guideline

where: $N_{Rk,c}^0$ according to Annex 6 or 8,

$S_{cr,sp}$ according to Annex 6 or 8,

$C_{cr,sp}$ according to Annex 6 or 8,

$\Psi_{ucr,N} = 1,0$

$\Psi_{h,sp} = 1,0$

- For the verification 'concrete pryout failure' (clause 5.2.3.3, Annex C of the Guideline) $N_{Rk,c}$ for equation (5.6), Annex C of the Guideline, shall be determined according to (1).

Verifiable calculation notes and drawings are prepared taking account of the loads to be anchored.

The position of the anchor is indicated on the design drawings (e.g. position of the anchor relative to reinforcement or to supports, etc.).

4.3 Installation of anchors

The fitness for use of the anchor can only be assumed if the anchor is installed as follows:

- anchor installation carried out by appropriately qualified personnel and under the supervision of the person responsible for technical matters of the site,
- use of the anchor only as supplied by the manufacturer without exchanging the components of an anchor,
- anchor installation in accordance with the manufacturer's specifications and drawings using the tools indicated in the technical documentation of this European technical approval,
- checks before placing the anchor to ensure that the strength class of the concrete in which the anchor is to be placed is in the range given and is not lower than that of the concrete to which the characteristic loads apply,
- check of concrete being well compacted, e.g. without significant voids,
- keeping the effective anchorage depth,
- edge distance and spacing not less than the specified values without minus tolerances,
- drilling using hard metal hammer-drill bits in accordance with ISO or National Standards,
- positioning of the drill holes without damaging the reinforcement,
- in case of aborted drill hole: the drill hole shall be filled with mortar,
- cleaning the drill hole: removing possibly existing water in the drill hole completely and cleaning the drill hole by at least 4x blowing,
- during installation and curing of the chemical mortar the temperature of the anchor components and the concrete must not fall below -5 °C; the curing time according to Annex 4 shall be observed before the anchor may be loaded,
- after the curing time fixing the member to be anchored by using a calibrated torque wrench by not exceeding the torque moment given in Annex 5,
- using only fastening screws with washer or threaded rods with washer and nut made of galvanised steel with the minimum strength class 8.8 EN ISO 898-1 for the internal sleeve.

5 Indications to the manufacturer

5.1 Responsibility of the manufacturer

The manufacturer is responsible to ensure that the information on the specific conditions according to 1 and 2 including Annexes referred to and 4.2 and 4.3 as well as 5.2 is given to those who are concerned. This information may be made by reproduction of the respective parts of the European technical approval. In addition all installation data shall be shown clearly on the package and/or on an enclosed instruction sheet, preferably using illustration(s).

The minimum data required are:

- drill bit diameter,
- hole depth,
- diameter of anchor rod,
- minimum effective anchorage depth,
- maximum thickness of the fixture,
- information on the installation procedure, including cleaning of the hole with the cleaning equipments, preferably by means of an illustration,
- anchor component installation temperature,
- ambient temperature of the concrete during installation of the anchor,
- admissible processing time (open time) of the mortar,
- curing time until the anchor may be loaded as a function of the ambient temperature in the concrete during installation,
- torque moment,
- identification of the manufacturing batch.

All data shall be presented in a clear and explicit form.

5.2 Packaging, transport and storage

The foil capsules shall be protected against sun radiation and shall be stored according to the manufacturer's installation instructions in dry condition at temperatures of at least +5 °C to not more than +25 °C.

Foil capsules with expired shelf life must no longer be used.

The anchor shall only be packaged and supplied as a complete unit. Foil capsules may be packed separately from anchor rods, nuts and washers or internal sleeves, respectively.

The manufacturer's installation instruction shall indicate that the foil capsules shall be used with the anchor rods HAS(-E)(-F) or internal sleeves HIS-N, respectively, according to Annex 3.

Georg Feistel
Head of Department

beglaubigt
Lange

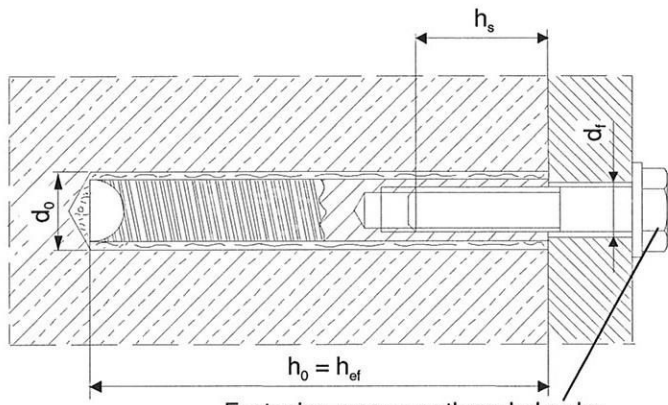
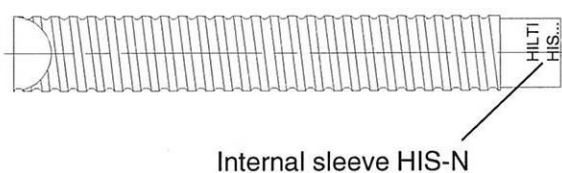
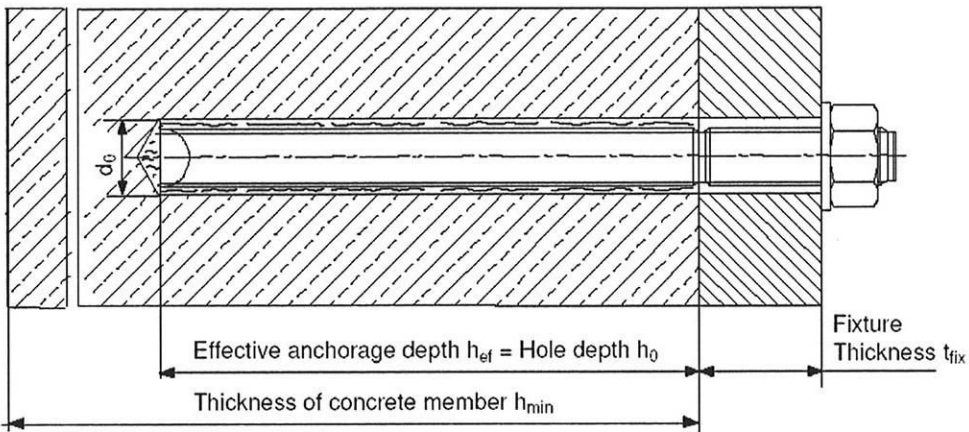
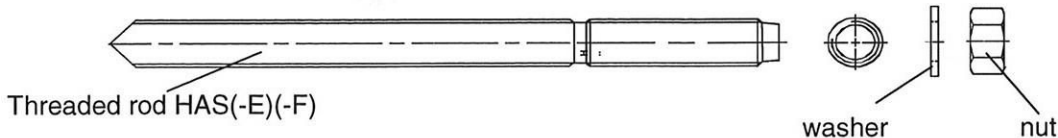

- Fastening screws or threaded rods:
- Strength class 8.8 EN ISO 898-1
 - Steel galvanized $\geq 5\mu\text{m}$

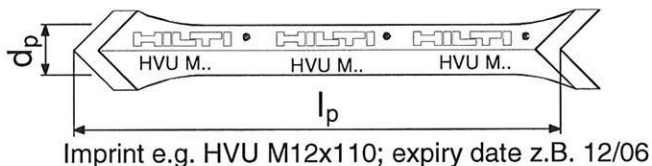

Use category according to ETAG 001 part 5:

- Use category 1: The anchor may be installed in dry or wet concrete, it must not be installed in flooded holes
- The anchor may only be used in structures subject to dry internal conditions

Temperature ranges

Range 1: -40°C to +40°C (max. short term temperature +40°C and max. long term temperature 24°C)

Range 2: -40°C to +80°C (max. short term temperature +80°C and max. long term temperature 50°C)

Range 3: -40°C to +120°C (max. short term temperature +120°C and max. long term temperature 72°C)

Hilti HVU with HAS(-E)(-F) and HIS-N	Annex 1
Product and intended use	of European technical approval ETA – 05/0255

Table 1a: Dimensions of foil capsules

Foil capsule HVU	M8x80	M10x90	M12x110	M16x125	M20x170	M24x210	M27x240	M30x270
diameter d_p [mm]	9,3	10,7	12,9	16,9	22,0	25,7	26,8	31,5
length l_p [mm]	100	110	127	140	170	200	225	260

Table 1b: Assignment of foil capsule

Foil capsule HVU	M8x80	M10x90	M12x110	M16x125	M20x170	M24x210	M27x240	M30x270
assigned HAS(-E)(-F)	M8x80	M10x90	M12x110	M16x125	M20x170	M24x210	M27x240	M30x270
assigned HIS-N	-	M8x90	M10x110	M12x125	M16x170	M20x205	-	-

Table 2: Materials

Designation	Marking	Material	
Foil capsule	HVU M ... x h _{ef}	Foil tube: Aggregate: Binder: Hardener:	PP-PET-PE Composition foil corundum (M8, M10), quartz sand (M12 - M30), reaction resin (styrene free) Dibenzoylperoxid

Hilti HVU with HAS(-E)(-F) and HIS-N

Foil capsule and material

Annex 2of European technical
approval

ETA – 05/0255

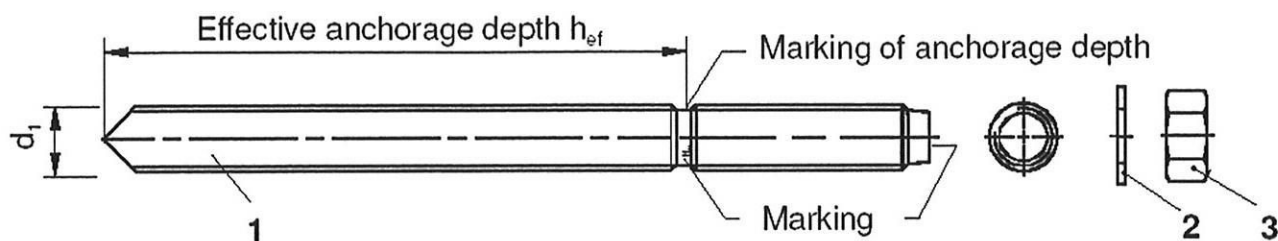

Marking: identifying mark – H and embossing „1“ (steel strength 5.8 for M8-M24)
or H and embossing “8” (steel strength 8.8 for M8-M30)

Table 3: Dimensions and embedment depths h_{ef} , anchor rods HAS(-E)(-F)

HAS(-E)(-F)	M8	M10	M12	M16	M20	M24	M27	M30
$\varnothing d_1$ [mm]	8	10	12	16	20	24	27	30
h_{ef} [mm]	80	90	110	125	170	210	240	270

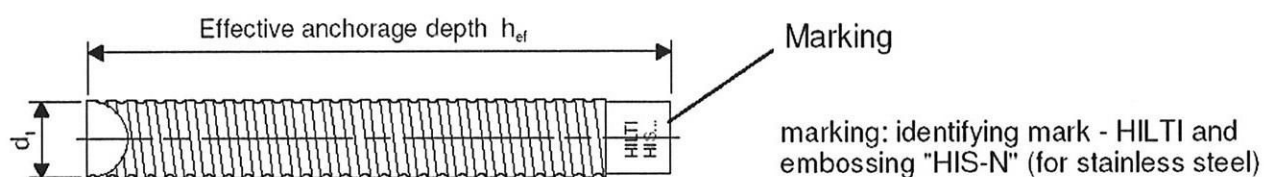

marking: identifying mark - HILTI and embossing "HIS-N" (for stainless steel)

Table 4: Dimensions of internal sleeves HIS-N

HIS-N	M8	M10	M12	M16	M20
$\varnothing d_1$ [mm]	12,5	16,5	20,5	25,4	27,6
h_{ef} [mm]	90	110	125	170	205
h_s [mm]	20	25	30	40	50

Table 5: Materials

part	Designation	C-Steel
Threaded rod HAS(-E)(-F)		
1	Threaded rod: HAS (-E)	strength class 5.8 (M8-M24) or 8.8 (M8-M30) EN ISO 898-1 steel galvanized $\geq 5\mu\text{m}$
	HAS (-E)-F	strength class 5.8 or 8.8 (M8-M30) EN ISO 898-1 hot dipped galvanized $\geq 45\mu\text{m}$
2	washer EN ISO 7089	steel galvanized resp. hot dipped galvanized
3	nut EN ISO 4032	strength class 8, ISO 898-2 steel galvanized $\geq 5\mu\text{m}$ resp. hot dipped galvanized $\geq 45\mu\text{m}$
Internal sleeve HIS-N		
1	Internal sleeve	C-Steel 1.0718, EN 10277-3 ISO 898-2 steel galvanized $\geq 5\mu\text{m}$

Hilti HVU with HAS(-E)(-F) and HIS-N

Dimensions and Materials of
threaded rods and internal sleeves

Annex 3

of European technical
approval

ETA – 05/0255

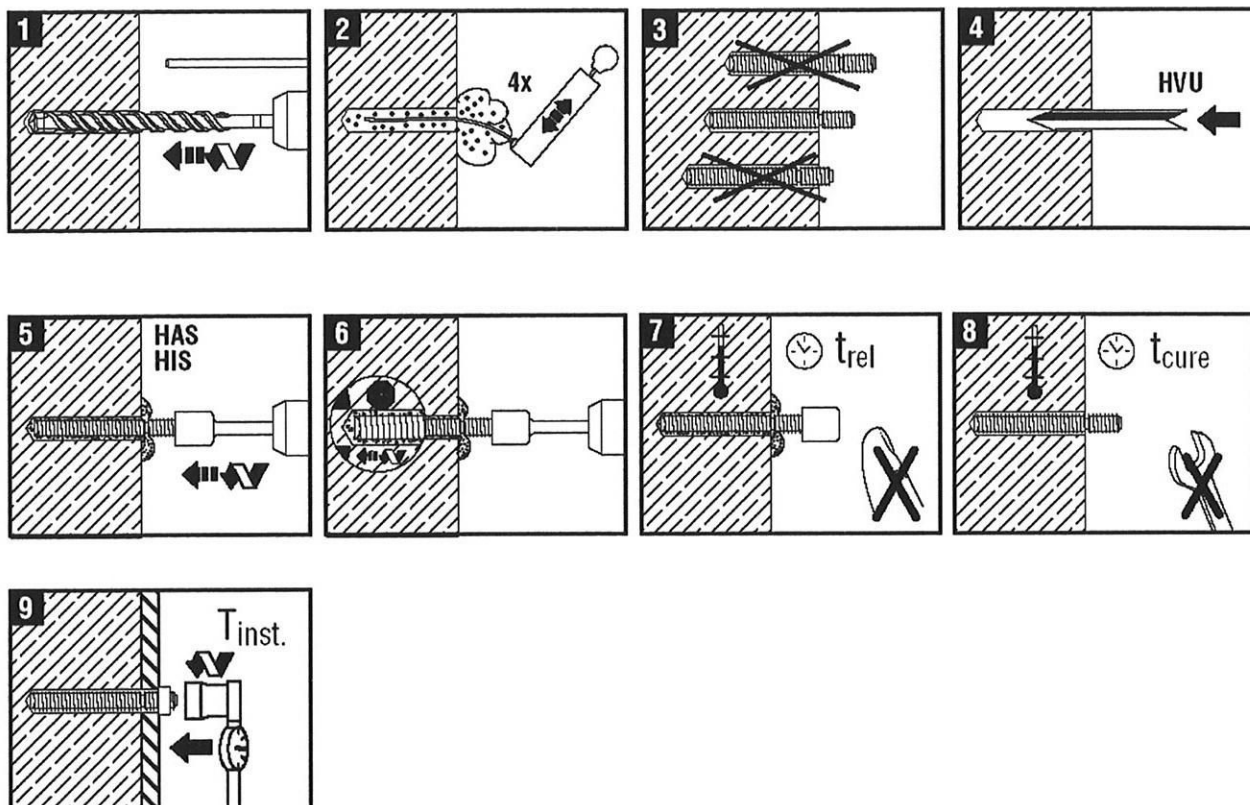

Figure 1: Installation Instruction and required cleaning accessories (manual pump or oil-free compressed air)

Table 6: Minimum curing time¹⁾

Base material temperature	min. curing time
-5 °C through -1 °C	5h
0 °C through 9 °C	1h
10 °C through 19 °C	30 min
20 °C through max. 40 °C	20 min

¹⁾ This table is valid for dry base materials only. In wet base materials the curing times must be doubled.

Hilti HVU with HAS(-E)(-F) and HIS-N

Installation instruction and curing times

Annex 4

of European technical approval

ETA – 05/0255

Table 7: Characteristic values of installation; minimum base material thickness, minimum edge distance and spacing for threaded rods HAS(-E)(-F)

HVU with HAS(-E)(-F)			M8	M10	M12	M16	M20	M24	M27	M30
Effective embedment depth	h_{ef}	[mm]	80	90	110	125	170	210	240	270
Nominal diameter of drill bit	d_0	[mm]	10	12	14	18	24	28	30	35
Cutting diameter of drill bit	$d_{cut} \leq$	[mm]	10,45	12,5	14,5	18,5	24,55	28,55	30,55	35,7
Depth of drilled hole	h_0	[mm]	80	90	110	125	170	210	240	270
Diameter of Clearance hole in the fixture	d_f	[mm]	9	12	14	18	22	26	30	33
Installation torque moment	T_{inst}	[Nm]	10	20	40	80	150	200	270	300
Minimum base material thickness	h_{min}	[mm]	110	120	140	170	220	270	300	340
minimum spacing	s_{min}	[mm]	40	45	55	65	90	120	130	135
minimum edge distance	c_{min}	[mm]	40	45	55	65	90	120	130	135

Table 8: Characteristic values of installation; minimum base material thickness, minimum edge distance and spacing for internal sleeves HIS-N

HVU with HIS-N			M 8	M 10	M 12	M 16	M 20
Effective embedment depth	h_{ef}	[mm]	90	110	125	170	205
Nominal diameter of drill bit	d_0	[mm]	14	18	22	28	32
Cutting diameter of drill bit	$d_{cut} \leq$	[mm]	14,5	18,5	22,55	28,55	32,7
Depth of drilled hole	h_0	[mm]	90	110	125	170	205
Diameter of Clearance hole in the fixture	d_f	[mm]	9	12	14	18	22
Installation torque moment	T_{inst}	[Nm]	10	20	40	80	150
Thread engagement length (min-max)	h_s	[mm]	8-20	10-25	12-30	16-40	20-50
Minimum base material thickness	h_{min}	[mm]	120	150	170	230	270
minimum spacing	s_{min}	[mm]	40	45	60	80	125
minimum edge distance	c_{min}	[mm]	40	45	60	80	125

Hilti HVU with HAS(-E)(-F) and HIS-N

Characteristic values of installation; minimum base material thickness, minimum edge distance and spacing

Annex 5

of European technical approval

ETA – 05/0255

Table 9: HAS(-E)(-F): Design method A
Characteristic values of resistance to tension load

HVU with HAS(-E)(-F)		M8	M10	M12	M16	M20	M24	M27	M30
Effective embedment depth	h_{ef} [mm]	80	90	110	125	170	210	240	270
Steel failure HAS(-E)(-F)									
Characteristic resistance for steel strength class 5.8	$N_{RK,s}$ [kN]	17	26	38	72	112	160	-	-
Characteristic resistance for steel strength class 8.8	$N_{RK,s}$ [kN]	27	41,5	61	115	179	256	347	422
Partial safety factor	$\gamma_{Ms}^{1)}$ [-]	1,5							
Pull out, concrete cone failure and splitting²⁾									
Characteristic resistance in non-cracked concrete C20/25; (40°C/24°C)	$N_{RK,c}^0 = N_{RK,p}$ [kN]	25	35	50	60	115	140	200	250
Optimized for minimum base material thickness									
minimum base material thickness	h_{min} [mm]	140	160	210	210	340	370	480	540
Splitting spacing	$S_{cr,sp}$ [mm]	320	360	440	500	680	840	960	1080
Splitting edge distance	$C_{cr,sp}$ [mm]	160	180	220	250	340	420	480	540
Optimized for minimum spacing									
base material thickness	$h=2 h_{ef}$ [mm]	160	180	220	250	340	420	480	540
Splitting spacing	$S_{cr,sp}$ [mm]	200	260	360	360	680	680	960	1080
Splitting edge distance	$C_{cr,sp}$ [mm]	100	130	180	180	340	340	480	540
Characteristic resistance in non-cracked concrete C20/25; (80°C/50°C)	$N_{RK,c}^0 = N_{RK,p}$ [kN]	20	25	40	50	75	115	140	170
Optimized for minimum base material thickness									
minimum base material thickness	h_{min} [mm]	110	120	170	170	220	300	340	380
Splitting spacing	$S_{cr,sp}$ [mm]	260	300	440	500	680	840	960	1080
Splitting edge distance	$C_{cr,sp}$ [mm]	130	150	220	250	340	420	480	540
Optimized for minimum spacing									
base material thickness	$h=2 h_{ef}$ [mm]	160	180	220	250	340	420	480	540
Splitting spacing	$S_{cr,sp}$ [mm]	160	180	220	250	340	420	480	540
Splitting edge distance	$C_{cr,sp}$ [mm]	80	90	110	125	170	210	240	270
Characteristic resistance in non-cracked concrete C20/25; (120°C/72°C)	$N_{RK,c}^0 = N_{RK,p}$ [kN]	9	12	16	25	40	60	75	75
minimum base material thickness	h_{min} [mm]	110	120	140	170	220	270	300	340
Splitting spacing	$S_{cr,sp}$ [mm]	160	180	220	250	340	420	480	540
Splitting edge distance	$C_{cr,sp}$ [mm]	80	90	110	125	170	210	240	270
Increasing factor in non cracked concrete	ψ_c	C30/37		1,06					
		C40/50		1,10					
		C50/60		1,13					
Spacing	$S_{cr,N}$ [mm]	2 h_{ef}							
Edge distance	$C_{cr,N}$ [mm]	1 h_{ef}							
Partial safety factor	$\gamma_{Mp} = \gamma_{Msp} = \gamma_{Mc}^{1)}$ [-]	1,5 ³⁾							

¹⁾ In absence of national regulations.

²⁾ Calculation of concrete failure and splitting see section 4.2.1.

³⁾ The partial safety factor $\gamma_2 = 1,0$ is included.

Hilti HVU with HAS(-E)(-F) and HIS-N

HAS(-E)(-F): Design method A
Characteristic values of resistance to tension load

Annex 6

of European technical approval

ETA – 05/0255

Table 10: HAS(-E)(-F): Displacement under tension load

HVU with HAS(-E)(-F)			M8	M10	M12	M16	M20	M24	M27	M30
(40°C / 24°C)										
Tension load in non-cracked concrete	N	[kN]	8,1	12,4	18,1	28,6	53,3	66,7	95,2	119,0
displacement	δ_{N0}	[mm]	0,15	0,2	0,2	0,2	0,3	0,3	0,4	0,45
displacement	$\delta_{N\infty}$	[mm]	0,4	0,45	0,5	0,55	0,8	0,8	1,0	1,1
(80°C / 50°C)										
Tension load in non-cracked concrete	N	[kN]	8,1	11,9	18,1	23,8	35,7	54,8	95,2	119,0
displacement	δ_{N0}	[mm]	0,15	0,15	0,2	0,2	0,2	0,25	0,25	0,3
displacement	$\delta_{N\infty}$	[mm]	0,4	0,4	0,5	0,5	0,55	0,65	0,65	0,7
(120°C / 72°C)										
Tension load in non-cracked concrete	N	[kN]	4,3	5,7	7,6	11,9	19,0	28,6	35,7	35,7
displacement	δ_{N0}	[mm]	0,1	0,1	0,1	0,1	0,1	0,15	0,15	0,15
displacement	$\delta_{N\infty}$	[mm]	0,2	0,2	0,2	0,25	0,3	0,35	0,35	0,35

Hilti HVU with HAS(-E)(-F) and HIS-N

Annex 7

HAS(-E)(-F): Displacement under tension load

of European technical approval

ETA – 05/0255

Table 11: HIS-N: Design method A
Characteristic values of resistance to tension load

HVU with HIS-N		M 8	M 10	M 12	M 16	M 20
Effective embedment depth	h_{ef} [mm]	90	110	125	170	205
Steel failure HIS-N with screw strength class 8.8						
Characteristic resistance	$N_{RK,s}$ [kN]	26	46	67	118	109
Partial safety factor	$\gamma_{Ms}^{1)}$ [-]	1,49	1,50		1,47	
Pull out, concrete cone failure and splitting²⁾						
Characteristic resistance in non-cracked concrete C20/25; (40°C/24°C)	$N_{RK,c}^0 = N_{RK,p}$ [kN]	25	40	60	95	140
Optimized for minimum base material thickness						
minimum base material thickness	h_{min} [mm]	120	150	180	250	350
Splitting spacing	$S_{cr,sp}$ [mm]	180	300	500	680	820
Splitting edge distance	$C_{cr,sp}$ [mm]	90	150	250	340	410
Optimized for minimum spacing						
minimum base material thickness	$h=2 h_{ef}$ [mm]	-	220	250	340	410
Splitting spacing	$S_{cr,sp}$ [mm]	-	220	250	340	500
Splitting edge distance	$C_{cr,sp}$ [mm]	-	110	125	170	250
Characteristic resistance in non-cracked concrete C20/25; (80°C/50°C)	$N_{RK,c}^0 = N_{RK,p}$ [kN]	20	35	50	75	95
minimum base material thickness	h_{min} [mm]	120	150	170	230	270
Splitting spacing	$S_{cr,sp}$ [mm]	180	220	300	340	440
Splitting edge distance	$C_{cr,sp}$ [mm]	90	110	150	170	220
Characteristic resistance in non-cracked concrete C20/25; (120°C/72°C)	$N_{RK,c}^0 = N_{RK,p}$ [kN]	9	16	20	40	50
minimum base material thickness	h_{min} [mm]	120	150	170	230	270
Splitting spacing	$S_{cr,sp}$ [mm]	180	220	250	340	410
Splitting edge distance	$C_{cr,sp}$ [mm]	90	110	125	170	205
Increasing factor in non cracked concrete	ψ_c	C30/37	1,12			
		C40/50	1,21			
		C50/60	1,28			
Spacing	$S_{cr,N}$ [mm]	2 h_{ef}				
Edge distance	$C_{cr,N}$ [mm]	1 h_{ef}				
Partial safety factor	$\gamma_{Mp} = \gamma_{Msp} = \gamma_{Mc}^{1)}$ [-]	1,5 ³⁾				

¹⁾ In absence of national regulations.

²⁾ Calculation of concrete failure and splitting see section 4.2.1.

³⁾ The partial safety factor $\gamma_2 = 1,0$ is included.

Hilti HVU with HAS(-E)(-F) and HIS-N

HIS-N: Design method A
 Characteristic values of resistance to tension load

Annex 8

of European technical approval

ETA – 05/0255

Table 12: HIS-N: Displacement under tension load

HVU with HIS-N			M8	M10	M12	M16	M20
(40°C / 24°C)							
Tension load in non-cracked concrete	N	[kN]	11,9	19,0	28,6	45,2	53,0
displacement	δ_{N0}	[mm]	0,2	0,2	0,25	0,3	0,35
displacement	$\delta_{N\infty}$	[mm]	0,5	0,55	0,65	0,8	0,85
(80°C / 50°C)							
Tension load in non-cracked concrete	N	[kN]	9,5	15,7	22,5	35,7	45,2
displacement	δ_{N0}	[mm]	0,15	0,2	0,2	0,25	0,3
displacement	$\delta_{N\infty}$	[mm]	0,4	0,45	0,5	0,65	0,7
(120°C / 72°C)							
Tension load in non-cracked concrete	N	[kN]	4,3	7,6	9,5	19,0	23,8
displacement	δ_{N0}	[mm]	0,1	0,1	0,1	0,15	0,15
displacement	$\delta_{N\infty}$	[mm]	0,2	0,2	0,2	0,35	0,4

Hilti HVU with HAS(-E)(-F) and HIS-N

Annex 9

HIS-N: Displacement under tension load

of European technical approval

ETA – 05/0255

Table 13: HAS(-E)(-F): Design method A
Characteristic values of resistance to shear load

HVU with HAS(-E)(-F)	M 8	M 10	M 12	M 16	M 20	M 24	M 27	M 30
Steel failure without lever arm HAS(-E)(-F)								
Characteristic resistance for steel strength class 5.8 $V_{Rk,s}$ [kN]	8,5	13	19	36	56	80	-	-
Characteristic resistance for steel strength class 8.8 $V_{Rk,s}$ [kN]	13,5	21	30,5	58	90	128	174	211
Partial safety factor $\gamma_{Ms}^{1)}$ [-]	1,25							
Steel failure with lever arm HAS(-E)(-F)								
Characteristic resistance for steel strength class 5.8 $M^0_{Rk,s}$ [Nm]	16	33	56	147	284	486	-	-
Characteristic resistance for steel strength class 8.8 $M^0_{Rk,s}$ [Nm]	25,5	53	90	234	455	777	1223	1637
Partial safety factor $\gamma_{Ms}^{1)}$ [-]	1,25							
Concrete pryout failure								
Factor in equation (5.6) of ETAG 001 Annex C, 5.2.3.3 k [-]	2,0							
Partial safety factor $\gamma_{Mcp}^{1)}$ [-]	1,5 ²⁾							
Concrete edge failure								
Effective anchorage depth l_f [mm]	80	90	110	125	170	210	240	270
Effective diameter of anchor d_{nom} [mm]	8	10	12	16	20	24	27	30
Partial safety factor $\gamma_{Mc}^{1)}$ [-]	1,5 ²⁾							

¹⁾ In absence of national regulations..

²⁾ The partial safety factor $\gamma_2 = 1,0$ is included.

Table 14: HAS(-E)(-F): Displacement under shear load

HVU with HAS(-E)(-F)	M8	M10	M12	M16	M20	M24	M27	M30
Shear load in non-cracked concrete V [kN]	4,9	7,4	10,9	20,6	32,0	45,7	99,4	120,6
displacement δ_{v0} [mm]	0,4	0,6	0,7	0,9	1,1	1,3	2,8	3,4
displacement $\delta_{v\infty}$ [mm]	0,6	0,9	1,1	1,4	1,7	2,0	4,2	5,1

Hilti HVU with HAS(-E)(-F) and HIS-N

Annex 10

HAS(-E)(-F): Design method A
Characteristic values of resistance and displacements
under shear load

of European technical
approval
ETA – 05/0255

Table 15: HIS-N: Design method A
Characteristic values of resistance to shear load

HVU with HIS-N		M 8	M 10	M 12	M 16	M20
Steel failure without lever arm HIS-N with screw strength class 8.8						
Characteristic resistance	$V_{Rk,s}$ [kN]	13	23	39	59	55
Partial safety factor	$\gamma_{Ms}^{1)}$ [-]	1,25		1,5		
Steel failure with lever arm HIS-N with screw strength class 8.8						
Characteristic resistance	$M^0_{Rk,s}$ [Nm]	30	60	105	266	519
Partial safety factor	$\gamma_{Ms}^{1)}$ [-]	1,25				
Concrete pryout failure						
Factor in equation (5.6) of ETAG 001 Annex C, 5.2.3.3	k [-]	2,0				
Partial safety factor	$\gamma_{Mcp}^{1)}$ [-]	1,5 ²⁾				
Concrete edge failure						
Effective anchorage depth	l_f [mm]	90	110	125	170	205
Effective diameter of anchor	d_{nom} [mm]	12,5	16,5	20,5	25,4	27,6
Partial safety factor	$\gamma_{Mc}^{1)}$ [-]	1,5 ²⁾				

¹⁾ In absence of national regulations..

²⁾ The partial safety factor $\gamma_2 = 1,0$ is included.

Table 16: HIS-N: Displacement under shear load

HVU with HIS-N		M8	M10	M12	M16	M20
Shear load in non-cracked concrete	V [kN]	7,4	13,1	18,6	28,1	26,2
displacement	δ_{V0} [mm]	0,7	1,0	1,1	1,6	2,0
displacement	$\delta_{V\infty}$ [mm]	1,1	1,5	1,7	2,4	3,0

Hilti HVU with HAS(-E)(-F) and HIS-N

Annex 11

HIS-N: Design method A
Characteristic values of resistance and displacements
under shear load

of European technical
approval
ETA – 05/0255