



European Technical Approval ETA-07/0288

English translation prepared by DIBt - Original version in German language

Handelsbezeichnung
Trade name

Hilti WDVS-Schraubdübel D 8-FV
Hilti ETICS screwed-in anchor D 8-FV

Zulassungsinhaber
Holder of approval

Hilti Aktiengesellschaft
Business Unit Anchors
9494 Schaan
FÜRSTENTUM LIECHTENSTEIN

Zulassungsgegenstand
und Verwendungszweck
*Generic type and use
of construction product*

Schraubdübel für die Befestigung von außenseitigen Wärmedämm-
Verbundsystemen mit Putzschicht in Beton und Mauerwerk
*Screwed-in plastic anchor for fixing of external thermal insulation
composite systems with rendering in concrete and masonry*

Geltungsdauer:
Validity: vom
from
bis
to

4 March 2011
7 February 2013

Herstellwerk
Manufacturing plant

Hilti Werke

Diese Zulassung umfasst
This Approval contains

17 Seiten einschließlich 7 Anhänge
17 pages including 7 annexes

Diese Zulassung ersetzt
This Approval replaces

ETA-07/0288 mit Geltungsdauer vom 23.04.2009 bis 07.02.2013
ETA-07/0288 with validity from 23.04.2009 to 07.02.2013

I LEGAL BASES AND GENERAL CONDITIONS

- 1 This European technical approval is issued by Deutsches Institut für Bautechnik in accordance with:
 - Council Directive 89/106/EEC of 21 December 1988 on the approximation of laws, regulations and administrative provisions of Member States relating to construction products¹, modified by Council Directive 93/68/EEC² and Regulation (EC) N° 1882/2003 of the European Parliament and of the Council³;
 - Gesetz über das In-Verkehr-Bringen von und den freien Warenverkehr mit Bauprodukten zur Umsetzung der Richtlinie 89/106/EWG des Rates vom 21. Dezember 1988 zur Angleichung der Rechts- und Verwaltungsvorschriften der Mitgliedstaaten über Bauprodukte und anderer Rechtsakte der Europäischen Gemeinschaften (Bauproduktengesetz - BauPG) vom 28. April 1998⁴, as amended by law of 31 October 2006⁵;
 - Common Procedural Rules for Requesting, Preparing and the Granting of European technical approvals set out in the Annex to Commission Decision 94/23/EC⁶;
 - Guideline for European technical approval of "Plastic anchors for fixing of external thermal insulation composite systems with rendering", ETAG 014.
- 2 Deutsches Institut für Bautechnik is authorized to check whether the provisions of this European technical approval are met. Checking may take place in the manufacturing plant. Nevertheless, the responsibility for the conformity of the products to the European technical approval and for their fitness for the intended use remains with the holder of the European technical approval.
- 3 This European technical approval is not to be transferred to manufacturers or agents of manufacturers other than those indicated on page 1, or manufacturing plants other than those indicated on page 1 of this European technical approval.
- 4 This European technical approval may be withdrawn by Deutsches Institut für Bautechnik, in particular pursuant to information by the Commission according to Article 5(1) of Council Directive 89/106/EEC.
- 5 Reproduction of this European technical approval including transmission by electronic means shall be in full. However, partial reproduction can be made with the written consent of Deutsches Institut für Bautechnik. In this case partial reproduction has to be designated as such. Texts and drawings of advertising brochures shall not contradict or misuse the European technical approval.
- 6 The European technical approval is issued by the approval body in its official language. This version corresponds fully to the version circulated within EOTA. Translations into other languages have to be designated as such.

¹ Official Journal of the European Communities L 40, 11 February 1989, p. 12
² Official Journal of the European Communities L 220, 30 August 1993, p. 1
³ Official Journal of the European Union L 284, 31 October 2003, p. 25
⁴ *Bundesgesetzblatt Teil I* 1998, p. 812
⁵ *Bundesgesetzblatt Teil I* 2006, p. 2407, 2416
⁶ Official Journal of the European Communities L 17, 20 January 1994, p. 34

II SPECIFIC CONDITIONS OF THE EUROPEAN TECHNICAL APPROVAL

1 Definition of product and intended use

1.1 Definition of the construction product

The Hilti ETICS screwed-in anchor D 8-FV with a helix consists of a plastic part made of polyamide and an accompanying specific screw of galvanised steel.

The installed anchors are shown in Annex 1.

1.2 Intended use

The anchor is intended to be used for anchorages for which requirements for safety in use in the sense of the Essential Requirement 4 of Council Directive 89/106/EEC shall be fulfilled and failure of anchorages made with these products would cause low risk to human life. The anchor is to be used only as multiple fixing for the anchorage of bonded thermal insulation composite systems (ETICS) according to ETAG 004 in concrete and masonry. The base material shall consist of reinforced or unreinforced normal weight concrete of strength class C12/15 at minimum and C50/60 at maximum according to EN 206-1:2000-12 or of masonry walls according to Annex 7, Table 7, of prefabricated reinforced components of lightweight aggregate concrete (LAC) according to EN 1520:2002+AC:2003 or autoclaved aerated concrete.

The base material may also consist of thin members $100 \text{ mm} > h \geq 40 \text{ mm}$ (e.g. weather resistant skin of external wall panels) made of reinforced or unreinforced normal weight concrete of strength class C12/15 at minimum and C50/60 at maximum.

The anchor may only be used for transmission of wind suction loads and shall not be used for the transmission of dead loads of the thermal insulation composite system. The dead loads have to be transmitted by the bonding of the thermal insulation composite system.

The provisions made in this European Technical Approval are based on an assumed working life of the anchor of 25 years. The indications given on the working life cannot be interpreted as a guarantee given by the producer, but are to be regarded only as a means for choosing the right products in relation to the expected economically reasonable working life of the works.

2 Characteristics of the product and methods of verification

2.1 Characteristics of the product

The anchor corresponds to the drawings and information given in Annex 2 and 3. The characteristic material values, dimensions and tolerances of the anchor not given in these Annexes shall correspond to the respective values laid down in the technical documentation⁷ of this European Technical Approval.

The characteristic values for the design of the anchorages are given in Annex 7.

Each anchor is to be marked with the name of the producer, the type and the total length of the anchor. The minimum effective anchorage depth shall be marked.

The anchor shall only be packaged and supplied as a complete unit.

⁷ The technical documentation of this European Technical Approval is deposited at the Deutsches Institut für Bautechnik and, as far as relevant for the tasks of the approved bodies involved in the attestation of conformity procedure, is handed over to the approved bodies.

2.2 Methods of verification

The assessment of the fitness of the anchor for the intended use in relation to the requirements for safety in use in the sense of the Essential Requirement 4 has been made in compliance with

- the Guideline for European Technical Approval of "Plastic Anchors for Fixing of External Thermal Insulation Composite Systems with Rendering", ETAG 014, based on the use categories A, B, C, D and E and
- the EOTA Technical Report TR 025 "Determination of point thermal transmittance of plastic anchors for the anchorage of external thermal insulation composite systems (ETICS)".

In addition to the specific clauses relating to dangerous substances contained in this European Technical Approval, there may be other requirements applicable to the products falling within its scope (e.g. transposed European legislation and national laws, regulations and administrative provisions). In order to meet the provisions of the Construction Products Directive, these requirements need also to be complied with, when and where they apply.

3 Evaluation and attestation of conformity and CE marking

3.1 System of attestation of conformity

According to the decision 97/463/EG of the European Commission⁸ the system 2(ii) (referred to as system 2+) of attestation of conformity applies.

This system of attestation of conformity is defined as follows.

System 2+: Declaration of conformity of the product by the manufacturer on the basis of:

- (a) Tasks for the manufacturer:
 - (1) initial type-testing of the product;
 - (2) factory production control;
 - (3) testing of samples taken at the factory in accordance with a prescribed test plan.
- (b) Tasks for the approved body:
 - (4) certification of factory production control on the basis of:
 - initial inspection of factory and of factory production control;
 - continuous surveillance, assessment and approval of factory production control.

3.2 Responsibilities

3.2.1 Tasks of the manufacturer

3.2.1.1 Factory production control

The manufacturer shall exercise permanent internal control of production. All the elements, requirements and provisions adopted by the manufacturer shall be documented in a systematic manner in the form of written policies and procedures, including records of results performed. This production control system shall insure that the product is in conformity with this European Technical Approval.

The manufacturer may only use raw materials stated in the technical documentation of this European Technical Approval.

⁸ Official Journal of the European Communities L 198 of 25.07.1997.

The factory production control shall be in accordance with the control plan which is part of the technical documentation of this European Technical Approval. The control plan is laid down in the context of the factory production control system operated by the manufacturer and deposited at Deutsches Institut für Bautechnik.⁹

The results of factory production control shall be recorded and evaluated in accordance with the provisions of the control plan.

3.2.1.2 Other tasks of manufacturer

The manufacturer shall, on the basis of a contract, involve a body which is approved for the tasks referred to in section 3.1 in the field of anchors in order to undertake the actions laid down in section 3.2.2. For this purpose, the control plan referred to in sections 3.2.1.1 and 3.2.2 shall be handed over by the manufacturer to the approved body involved.

The manufacturer shall make a declaration of conformity, stating that the construction product is in conformity with the provisions of this European Technical Approval.

3.2.2 Tasks of approved bodies

The approved body shall perform

- the initial inspection of factory and of factory production control,
- continuous surveillance, assessment and approval of factory production control,

in accordance with the provisions laid down in the control plan.

The approved body shall retain the essential points of its actions referred to above and state the results obtained and conclusions drawn in a written report.

The approved certification body involved by the manufacturer shall issue an EC certificate of conformity of the factory production control stating the conformity with the factory production control of this European Technical Approval.

In cases where the provisions of the European Technical Approval and its control plan are no longer fulfilled the certification body shall withdraw the certificate of conformity and inform Deutsches Institut für Bautechnik without delay.

3.3 CE marking

The CE marking shall be affixed on each packaging of the anchor. The letters "CE" shall be followed by the identification number of the approved certification body, where relevant, and be accompanied by the following additional information:

- the name and address of the producer (legal entity responsible for the manufacturer),
- the last two digits of the year in which the CE marking was affixed,
- the number of the EC certificate for the factory production control,
- the number of the European Technical Approval,
- the number of the guideline for European Technical Approval,
- use categories A, B, C (D 8-FV 125) or use categories A, B, C, D and E (D 8-FV 155 and D 8-FV 215).

⁹

The control plan is a confidential part of the documentation of the European Technical Approval, but not published together with the ETA and only handed over to the approved body involved in the procedure of attestation of conformity. See section 3.2.2.

4 Assumptions under which the fitness of the product for the intended use was favourably assessed

4.1 Manufacturing

The European Technical Approval is issued for the product on the basis of agreed data/information, deposited with Deutsches Institut für Bautechnik, which identifies the product that has been assessed and judged. Changes to the product or production process, which could result in this deposited data/information being incorrect, should be notified to Deutsches Institut für Bautechnik before the changes are introduced. Deutsches Institut für Bautechnik will decide whether or not such changes affect the ETA and consequently the validity of the CE marking on the basis of the ETA and if so whether further assessment or alterations to the ETA shall be necessary.

4.2 Design of anchorages

4.2.1 General

Fitness for the intended use of the anchor is given under the following conditions:

- The design of anchorages is carried out in compliance with ETAG 014 "Guideline for European Technical Approval of Plastic Anchors for Fixing of External Thermal Insulation Composite Systems with Rendering" under the responsibility of an engineer experienced in anchorages.
- Verifiable calculation notes and drawings shall be prepared taking account of the loads to be anchored, the nature and strength of the base materials, the thickness of insulation and the dimensions of the anchorage members as well as of the relevant tolerances.
- The anchor shall only be used for the transmission of wind suction loads. All other loads such as dead load and restraints shall be transmitted by the adhesion of the relevant external thermal insulation composite system.

Verification of stability of the external thermal insulation composite system including application of loads on the anchor and on the additional plates is not subject of this European Technical Approval.

4.2.2 Resistance

The characteristic values of the tension resistance of the anchor are given in Annex 7, Table 7. If there is a difference in the characteristic values of the base material in Table 7 or a similar base material of use category B, C and D is supposed to be used; job-site tests according to 4.4 shall be carried out and the characteristic tension resistance shall be determined.

4.2.3 Characteristic values, spacing and dimensions of anchorage member

The minimum spacing and dimensions of anchorage member according to Annex 5 shall be observed.

4.2.4 Displacement behaviour

The displacements are given in the following table.

Table 4.1: Displacements for Hilit D 8-FV

Base material	Bulk density class ρ [kg/dm ³]	Minimum compressive strength f_b [N/mm ²]	Tension load N [kN]	Displacements $\delta_m(\mathbf{N})$ [mm]
Concrete C12/15 - C50/60 (EN 206-1)			0,50	0,4
Concrete C12/15 - C50/60 thin members 100 mm > h ≥ 40 mm			0,50	0,4
Sand-lime solid brick, KS (DIN V 106/EN 771-2)	≥ 2,0	12	0,50	0,7
Clay brick, Mz (DIN V 105-100/EN 771-1)	≥ 2,0	12	0,50	0,5
Vertically perforated sand-lime brick, KSL (DIN V 106/EN 771-2)	≥ 1,4	12	0,40	0,4
Vertically perforated clay brick, HLz (DIN V 105-100/EN 771-1)	≥ 1,2	12	0,25	0,2
Lightweight aggregate concrete, LAC (DIN EN 1520)	≥ 1,2	12	0,40	0,1
Autoclaved aerated concrete, AAC (DIN V 4165-100/EN 771-4)	≥ 1,2	12	0,30	0,2

4.2.5 Point thermal transmittance according EOTA Technical Report TR 025

The point thermal transmittance (CHI-value) of the anchor according EOTA Technical Report TR 025 "Determination of point thermal transmittance of plastic anchors for the anchorage of external thermal insulation composite systems (ETICS)" is given in the following table for use category A, B, C, D and E respectively.

Table 4.2: Point thermal transmittance

Anchor type	Insulation thickness h_D [mm]	Point thermal transmittance χ [W/K]	
		Gap filled with plug	Gap filled with PU-foam ¹⁾
Hilti D 8-FV 125 Hilti D 8-FV 155 Hilti D 8-FV 215 with $t_{fix} = 80\text{mm}$	$100 \leq h_D \leq 150$	0,001	0,001
	$150 < h_D \leq 360$	0,001	0,000
Hilti D 8-FV 155 Hilti D 8-FV 215 with $t_{fix} = 110\text{mm}$	$140 \leq h_D \leq 150$	0,002	0,002
	$150 < h_D \leq 360$	0,001	0,001

¹⁾ For PU-foam specification see Annex 3, Table 2

4.3 Installation of anchor

The fitness for use of the anchor can only be assumed if the following conditions of installation are met:

- Anchor installation carried out by appropriately qualified personnel under the supervision of the person responsible for technical matters on site.
- Use of the anchor only as supplied by the manufacturer without exchanging any component of the anchor.
- Anchor installation in accordance with the manufacturer's specifications and drawings (Annex 6) using the tools indicated in this European Technical Approval.
- Checks before placing the anchor, to ensure that the characteristic values of the base material in which the anchor is to be placed, is identical with the values, which the characteristic loads apply for.
- Observation of the drill method (Drill holes in masonry made of vertically perforated clay bricks may only be drilled using the rotary drill. Other drilling methods may also be used if job-site tests according to 4.4 evaluate the influence of hammer or impact drilling.)
- Placing drill holes without damaging the reinforcement
- Observation of the different overall plastic anchor embedment depths for use category A, B, C ($h_{\text{nom},1} \geq 25 \text{ mm}$) and use category D, E ($h_{\text{nom},2} \geq 55 \text{ mm}$) according to Annex 4, Table 4 and 5.
- Temperature during installation of the anchor $\geq 0 \text{ °C}$
- Final filling of the gap in the insulation with a plug or with PU-foam (Annex 6).

4.4 Job site tests

4.4.1 General

The characteristic tension resistance of the anchor may be determined by means of job site pull-out tests carried out on the material actually used, if a characteristic resistance of the base material does not exist (for example masonry made of other solid masonry units, hollow or perforated bricks, hollow blocks).

The characteristic resistance of the anchor shall be determined by carrying out at least 15 centric tension load pull-out tests on site. These tests are also possible under the same conditions in a laboratory.

Execution and evaluation of the tests as well as the issue of the test report and the determination of the characteristic resistance should be under the responsibility of approved testing laboratories or the supervision of the person responsible for the execution of the works on site.

Number and position of the anchors to be tested shall be adapted to the relevant special conditions of the site and, for example, to be increased in the case of hidden and larger areas, such that reliable information about the characteristic resistance of the anchor in the base material in question can be derived. The tests shall take into account the most unfavourable conditions of the practical execution.

4.4.2 Assembly

The anchor to be tested shall be installed (e.g. preparation of drill hole, drilling tool to be used, drill bit) and the spacing and the edge distances shall be in the same way as planned for the fixing of the external thermal insulation composite system.

Depending on the drilling tool and according to ISO 5468, hard metal hammer-drill bits or hard metal percussion drill bits, respectively, shall be used. The cutting diameter shall be at the upper tolerance limit.

4.4.3 Execution of test

The test rig used for the pull-out tests shall provide a continuous slow increase of the load, controlled by a calibrated load cell. The load shall apply perpendicular to the surface of the base material and shall be transmitted to the anchor via a hinge. The reaction forces shall be transmitted into the base material at a distance of at least 15 cm from the anchor. The load shall be increased continuously in a way that the ultimate load is reached after about 1 minute. The load is measured when the ultimate load (N_1) is achieved.

4.4.4 Test report

The test report shall include all information necessary to assess the resistance of the tested anchor. It shall be included in the construction dossier.

The minimum data required are:

- Construction site, owner of building; date and location of the tests, air temperature; type of member (ETICS) to be fixed
- Masonry (type of brick, strength class, all dimensions of bricks, mortar group); Visual assessment of masonry (flush joints, joint clearance, regularity)
- Plastic anchor and screw; value of the cutting diameter of hard metal hammer-drill bits, measured before and after drilling
- Test rig; results of tests including the indication of value N_1
- Tests carried out or supervised by; signature

4.4.5 Evaluation of test results

The characteristic resistance N_{RK1} is obtained from the measured values of N_1 as follows:

$$N_{RK1} = 0,6 \cdot N_1 \leq 1,5 \text{ kN}$$

N_1 = the mean value of the five smallest measured values at the ultimate load

5 Indications for the manufacturer

5.1 Responsibility of the manufacturer

It is in the responsibility of the manufacturer to ensure that the information on the specific conditions according to 1 and 2 including Annexes referred to 4 is given to those who are concerned. This information may be made by reproduction of the respective parts of the European Technical Approval. In addition, all installation data shall be shown clearly on the packaging and/or on an enclosed instruction sheet, preferably using illustrations.

The minimum data required are:

- base material for the intended use,
- drill bit diameter,
- maximum thickness of the ETICS,
- minimum effective anchorage depth,
- minimum hole depth,
- information on the installation procedure,
- identification of the manufacturing batch.

All data shall be presented in a clear and explicit form.

European technical approval

ETA-07/0288

English translation prepared by DIBt

Page 10 of 10 | 4 March 2011

5.2 Packaging, transport and storage

The anchor shall only be packaged and supplied as a complete unit.

The anchor shall be stored under normal climatic conditions in its original light-proof packaging. Before installation, it shall not be extremely dried nor frozen.

Georg Feistel
Head of Department

beglaubigt
Scheller

English translation prepared by DIBt

Hilti ETICS anchor D 8-FV

Intended use: Fixing of external thermal insulation composite systems in concrete, masonry, lightweight aggregate concrete and autoclaved aerated concrete

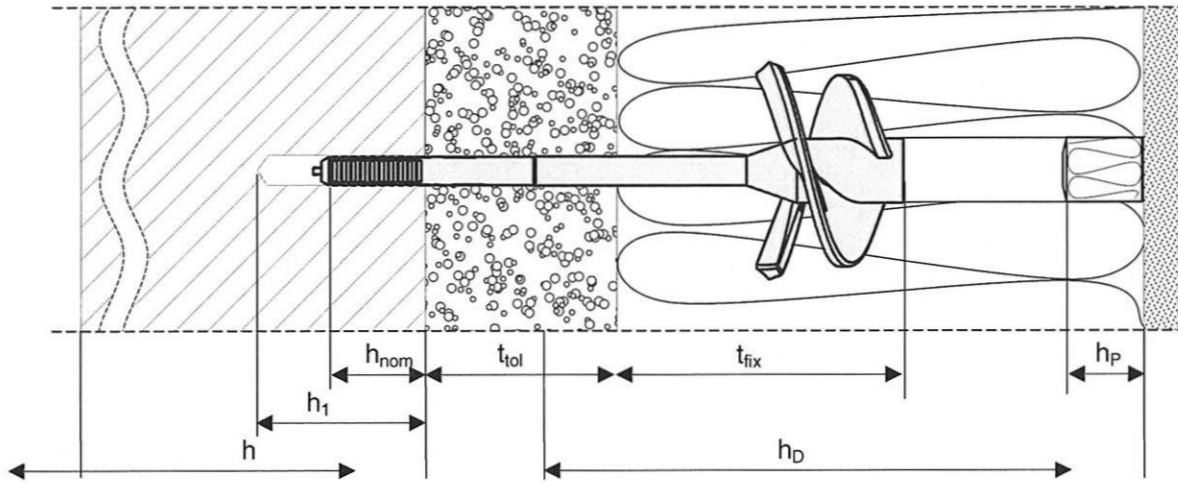

Use in different insulation thickness (≥ 100 mm)

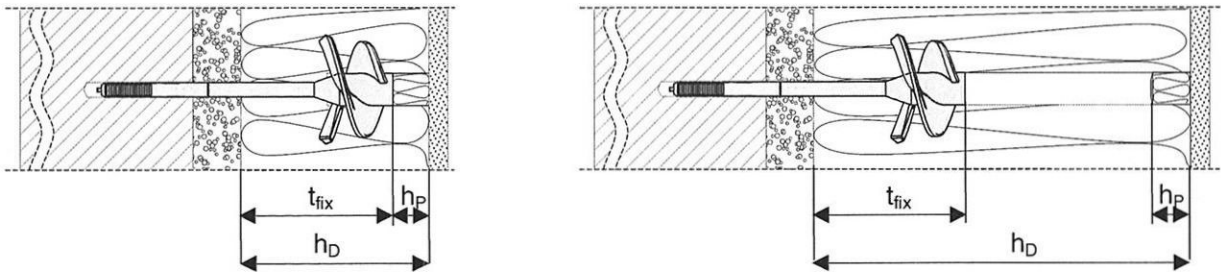

Use in different thickness of equalizing or non-loadbearing layer

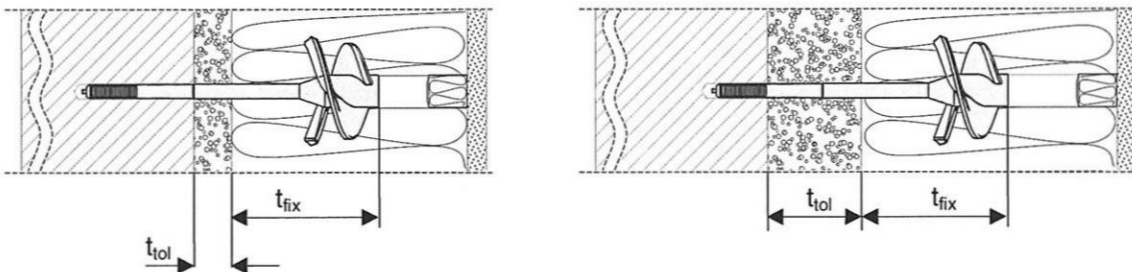

h = thickness of member (wall)
 h_1 = depth of drilled hole to deepest point
 h_{nom} = overall plastic anchor embedment depth in the base material
 h_D = thickness of insulation material (≥ 100 mm)

h_P = thickness of plug
 t_{fix} = thickness of fixture
 t_{tol} = thickness of equalizing layer for compensation of tolerances or non-loadbearing layer (≤ 110 mm)

Hilti ETICS anchor D 8-FV

Intended use

Annex 1

English translation prepared by DIBt

Anchor sleeve

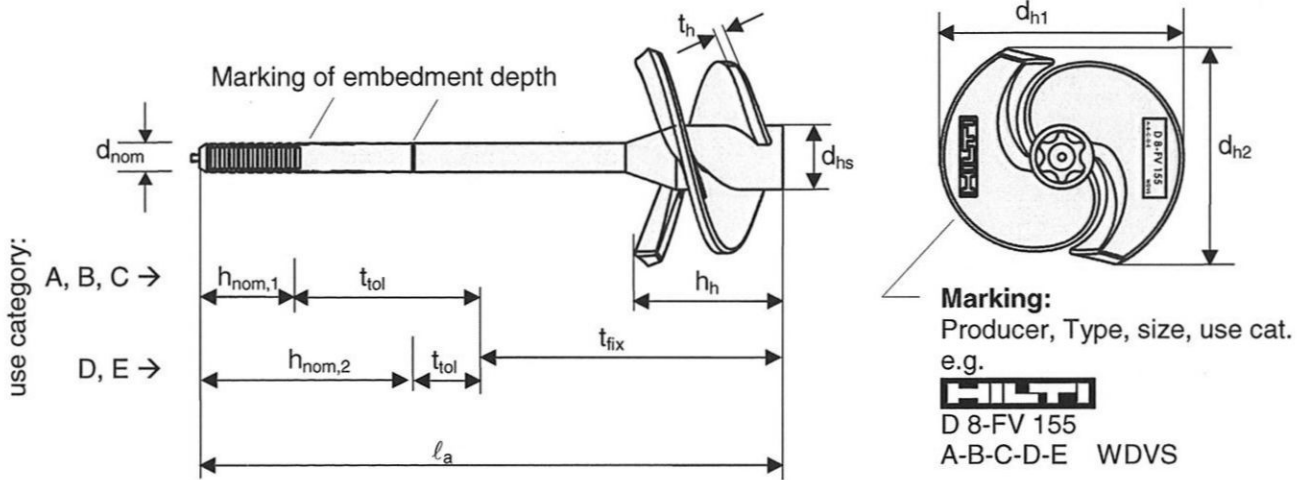

Screw

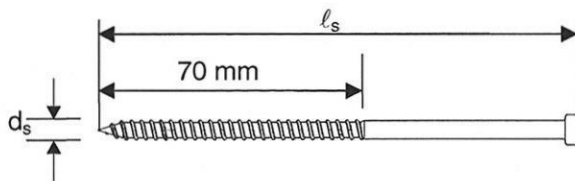

Plug

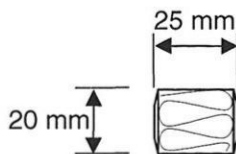

PU-Foam (alternative to plug)

Specification see Table 3

Setting tool

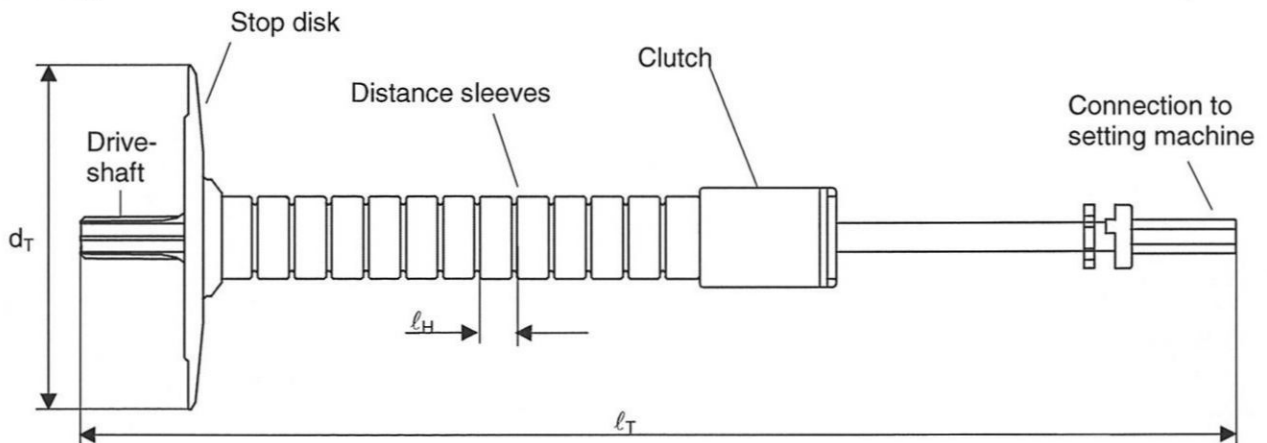

Hilti ETICS anchor D 8-FV

System Components

Annex 2

English translation prepared by DIBt

Table 1: Anchor types and dimensions

Anchor type		D 8-FV 125	D 8-FV 155	D 8-FV 215
Plastic sleeve	Sleeve diameter d_{nom} [mm]	8		
	Length of sleeve l_a [mm]	125	155	215
	Height of helix h_h [mm]	40		
	Thickness of helix t_h [mm]	3		
	Diameter of helix centre d_{hs} [mm]	17		
	Diameter 1 of helix d_{h1} [mm]	65		
	Diameter 2 of helix d_{h2} [mm]	58		
Special screw	Screw diameter d_s [mm]	5		
	Length of screw l_s [mm]	98	128	188

Table 2: Materials

Element	Material
Anchor sleeve	Polyamide, colour orange
Screw	Steel, galvanised $\geq 5 \mu\text{m}$, blue passivated, $f_{yk} = 600 \text{ N/mm}^2$, $f_{uk} = 480 \text{ N/mm}^2$
Plug	EPS
PU-Foam	Polyurethane, thermal conductivity $\leq 0,045 \text{ W/(m}\cdot\text{K)}$ <i>Remark: Use of foam only in accordance with ETICS system suppliers.</i>

Table 3: Setting-tool types and dimensions

Setting tool type		D 8-SW 1	D 8-SW 2
Diameter of disk d_T [mm]		100	
Length of the tool l_T [mm]		310	477
Length of distance sleeve l_H [mm]		10	
Applicable insulation thickness	$h_{D,min}$ [mm]	100 ¹⁾	200
	$h_{D,max}$ [mm]	200	360

¹⁾ This value applies for $t_{fix} = 80 \text{ mm}$. If $t_{fix} = 110 \text{ mm}$ the $h_{D,min} = 130 \text{ mm}$.

Hilti ETICS anchor D 8-FV	Annex 3
Anchor types and dimensions, materials Setting tool types and dimensions	

Table 4: Installation parameters for use in concrete and masonry (use category A, B, C)

Anchor type		D 8-FV 125	D 8-FV 155	D 8-FV 215	
Drill hole diameter	$d_0 =$ [mm]	8			
Cutting diameter of drill bit	$d_{cut} \leq$ [mm]	8,45			
Depth of drilled hole to deepest point	$h_1 \geq$ [mm]	45			
Overall plastic anchor embedment depth in the base material	$h_{nom,1} \geq$ [mm]	25			
Relation of t_{fix} and t_{tol} and overall drilling depth	$t_{fix} =$ [mm]	80	80	80	110
	$t_{tol, min} =$ [mm]	0	0 ¹⁾	50 ²⁾	20 ³⁾
	$t_{tol, max} =$ [mm]	20	50	110 ⁴⁾	80 ⁴⁾
	$h_1 + t_{tol} \geq$ [mm]	65	95	155	125
Installation temperature	[°C]	0 to +40			

For use in hollow and perforated masonry and thin concrete members (e.g. weather resistant skin of external wall panels) the minimum thickness of equalizing layer for compensation of tolerances or non-loadbearing layer is

¹⁾ $t_{tol, min} = 20$ mm ²⁾ $t_{tol, min} = 80$ mm ³⁾ $t_{tol, min} = 50$ mm.

This limitation can be omitted if the anchor performance is tested on site.

⁴⁾ If $t_{tol, max}$ exceeds 50 mm it has to be ensured that the material t_{tol} has enough capability to carry the dead load of the ETICS. This can be considered as given if t_{tol} consists of plaster, old insulation or shells of jacket blocks.

Table 5: Installation parameters for use in lightweight aggregate concrete and autoclaved aerated concrete (use category D, E)

Anchor type		D 8-FV 155	D 8-FV 215	
Drill hole diameter	$d_0 =$ [mm]	8		
Cutting diameter of drill bit	$d_{cut} \leq$ [mm]	8,45		
Depth of drilled hole to deepest point	$h_1 \geq$ [mm]	75		
Overall plastic anchor embedment depth in the base material	$h_{nom} \geq$ [mm]	55		
Relation of t_{fix} and t_{tol} and overall drilling depth	$t_{fix} =$ [mm]	80	80	110
	$t_{tol, min} =$ [mm]	0	0	0
	$t_{tol, max} =$ [mm]	20	80 ¹⁾	50
	$h_1 + t_{tol} \geq$ [mm]	95	155	125
Installation temperature	[°C]	0 - +40		

¹⁾ If $t_{tol, max}$ exceeds 50 mm it has to be ensured that the material t_{tol} has enough capability to carry the dead load of the ETICS. This can be considered as given if t_{tol} consists of plaster, old insulation or shells of jacket blocks.

Hilti ETICS anchor D 8-FV

Installation parameters

Annex 4

English translation prepared by DIBt

Table 6: Minimum thickness of base material, edge distance and anchor spacing

			D 8-FV
Minimum thickness of the base material	concrete, masonry, lightweight aggregate concrete and autoclaved aerated concrete	h_{min} [mm]	100
	thin skins (only concrete)	h_{min} [mm]	40
Minimum allowable spacing		s_{min} [mm]	100
Minimum allowable edge distance		c_{min} [mm]	100

Scheme of distances and spacing

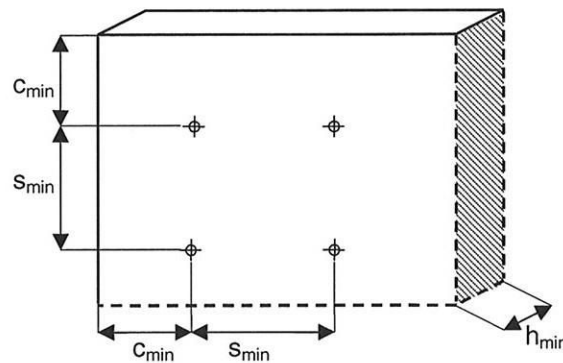

Hilti ETICS anchor D 8-FV

Minimum thickness of base material,
edge distance and anchor spacing

Annex 5

English translation prepared by DIBt

Setting instruction (also part of each sales package)

D 8-FV 125					
D 8-FV 155					
D 8-FV 215					

l_b	SW1	SW2
100...200 mm	✓	✗
200...360 mm	✗	✓

D 8-SW 1	
0	200 mm
1	180 mm
2	170 mm
3	160 mm
4	150 mm
5	140 mm
6	130 mm
7	120 mm
8	110 mm
9	100 mm

D 8-SW 2	
0	360 mm
1	350 mm
2	340 mm
3	330 mm
4	320 mm
5	310 mm
6	300 mm
7	290 mm
8	280 mm
9	270 mm
10	260 mm
11	250 mm
12	240 mm
13	230 mm
14	220 mm
15	210 mm
16	200 mm

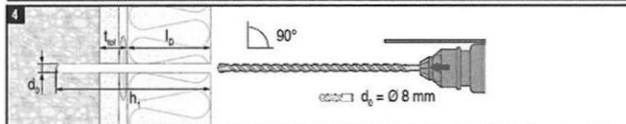
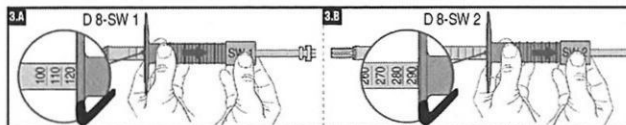

D8-FV 125	$l_b + 65$ mm	✓	✓	✗	✗
D8-FV 155	$l_b + 95$ mm	✓	✓	✓	✓
D8-FV 215	$l_b + 155$ mm	✓	✓	$l_b + 80...110$ mm	✓

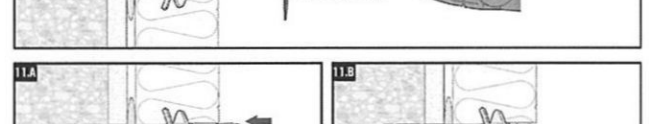
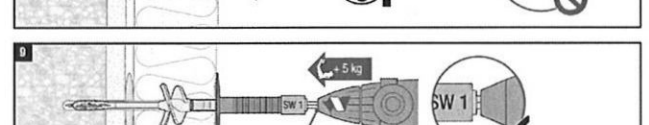
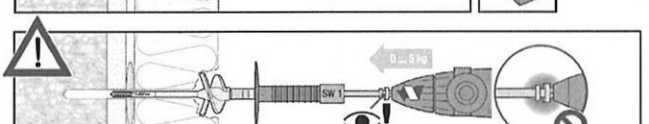
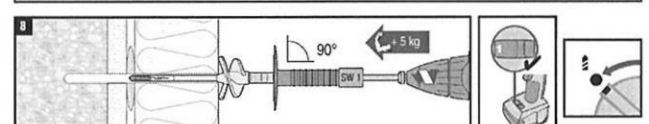
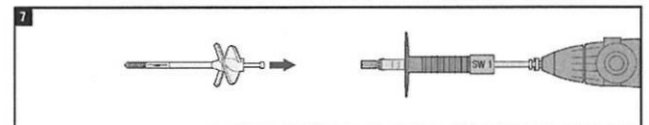
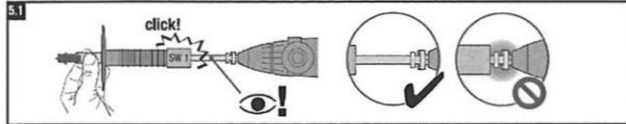
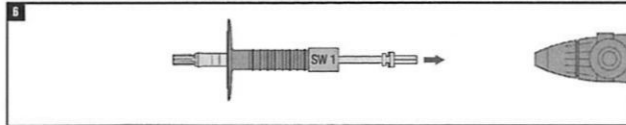

Hilti ETICS anchor D 8-FV

Setting instruction

Annex 6

Table 7: Characteristic resistance to tension loads N_{Rk} in concrete, masonry, light-weight aggregate concrete and autoclaved aerated concrete for single anchor

Base material	Use cat. ³⁾	Bulk density class ρ [kg/dm ³]	Compressive strength-class f_b [N/mm ²]	Remarks	Drill method	N_{Rk} [kN]
Concrete C12/15 – C50/60 EN 206-1	A	-	-	-	hammer	1,5
Thin concrete members (e.g. weather resistant skin of external wall panels) (C16/20 – C50/60)	A	-	-	Thickness of the thin skin 100 mm > h ≥ 40mm	hammer	1,5
Clay brick Mz 12/2,0 DIN V 105-100 / EN 771-1	B	2	12	Cross section reduced up to 15% by perforation vertically to the resting area	hammer	1,5
Sand-lime solid brick KS 12/2,0 DIN V 106 / EN 771-2	B	2	12	Cross section reduced up to 15% by perforation vertically to the resting area	hammer	1,5
Vertically perforated clay brick HLz 12/1,2 DIN V 105-100 / EN 771-1	C	1,2	12	Cross section reduced more than 15% and less than 50% by perforation vertically to the resting area ¹⁾	rotary only	0,75
Vertically perforated sand-lime brick KSL 12/1,4 DIN V 106 / EN 771-2	C	1,4	12	Cross section reduced more than 15% by perforation vertically to the resting area ²⁾	hammer	1,2
Lightweight aggregate concrete LAC DIN EN 1520	D	1,2	4	-	hammer	1,2
Autoclaved aerated concrete AAC DIN V 4165-100 / EN 771-4	E	0,6	4	-	rotary only	0,9
Partial safety factor for anchor resistance (valid in absence of national regulations)					γ_M	2,0

¹⁾ The value applies only for outer web thickness ≥ 14 mm

²⁾ The value applies only for outer web thickness ≥ 24 mm

³⁾ Different installation parameters for use categories A, B, C and use categories D, E to be considered (see Annex 4, Table 4 and 5)

Otherwise the characteristic resistance shall be determined by job-site pull-out tests acc. 4.4

Hilti ETICS anchor D 8-FV

Characteristic resistance to tension load

Annex 7