

European Technical Approval ETA-10/0261

English translation prepared by DIBt - Original version in German language

Handelsbezeichnung <i>Trade name</i>	SIKLA Injektionssystem VMU für Beton <i>SIKLA Injection system VMU for concrete</i>
Zulassungsinhaber <i>Holder of approval</i>	Sikla Holding Ges.m.b.H. Kornstraße 14 4614 MARCHTRENK ÖSTERREICH
Zulassungsgegenstand und Verwendungszweck <i>Generic type and use of construction product</i>	Verbunddübel mit Ankerstange in den Größen M8, M10, M12, M16, M20, M24 und M30 zur Verankerung im ungerissenen Beton <i>Bonded anchor with anchor rod of sizes M8, M10, M12, M16, M20, M24 and M30 for use in non-cracked concrete</i>
Geltungsdauer: <i>Validity:</i>	9 July 2010
	19 January 2011
verlängert <i>extended</i>	19 January 2011
	19 January 2016
Herstellwerk <i>Manufacturing plant</i>	Sikla Herstellwerk 1

Diese Zulassung umfasst
This Approval contains

17 Seiten einschließlich 8 Anhänge
17 pages including 8 annexes

I LEGAL BASES AND GENERAL CONDITIONS

- 1 This European technical approval is issued by Deutsches Institut für Bautechnik in accordance with:
 - Council Directive 89/106/EEC of 21 December 1988 on the approximation of laws, regulations and administrative provisions of Member States relating to construction products¹, modified by Council Directive 93/68/EEC² and Regulation (EC) N° 1882/2003 of the European Parliament and of the Council³;
 - Gesetz über das In-Verkehr-Bringen von und den freien Warenverkehr mit Bauprodukten zur Umsetzung der Richtlinie 89/106/EWG des Rates vom 21. Dezember 1988 zur Angleichung der Rechts- und Verwaltungsvorschriften der Mitgliedstaaten über Bauprodukte und anderer Rechtsakte der Europäischen Gemeinschaften (Bauproduktengesetz - BauPG) vom 28. April 1998⁴, as amended by law of 31 October 2006⁵;
 - Common Procedural Rules for Requesting, Preparing and the Granting of European technical approvals set out in the Annex to Commission Decision 94/23/EC⁶;
 - Guideline for European technical approval of "Metal anchors for use in concrete - Part 5: Bonded anchors", ETAG 001-05.
- 2 Deutsches Institut für Bautechnik is authorized to check whether the provisions of this European technical approval are met. Checking may take place in the manufacturing plant. Nevertheless, the responsibility for the conformity of the products to the European technical approval and for their fitness for the intended use remains with the holder of the European technical approval.
- 3 This European technical approval is not to be transferred to manufacturers or agents of manufacturers other than those indicated on page 1, or manufacturing plants other than those indicated on page 1 of this European technical approval.
- 4 This European technical approval may be withdrawn by Deutsches Institut für Bautechnik, in particular pursuant to information by the Commission according to Article 5(1) of Council Directive 89/106/EEC.
- 5 Reproduction of this European technical approval including transmission by electronic means shall be in full. However, partial reproduction can be made with the written consent of Deutsches Institut für Bautechnik. In this case partial reproduction has to be designated as such. Texts and drawings of advertising brochures shall not contradict or misuse the European technical approval.
- 6 The European technical approval is issued by the approval body in its official language. This version corresponds fully to the version circulated within EOTA. Translations into other languages have to be designated as such.

¹ Official Journal of the European Communities L 40, 11 February 1989, p. 12

² Official Journal of the European Communities L 220, 30 August 1993, p. 1

³ Official Journal of the European Union L 284, 31 October 2003, p. 25

⁴ *Bundesgesetzblatt Teil I* 1998, p. 812

⁵ *Bundesgesetzblatt Teil I* 2006, p. 2407, 2416

⁶ Official Journal of the European Communities L 17, 20 January 1994, p. 34

II SPECIFIC CONDITIONS OF THE EUROPEAN TECHNICAL APPROVAL

1 Definition of the construction product and intended use

1.1 Definition of the product

The SIKLA Injection System VMU for concrete is a bonded anchor consisting of a mortar cartridge with SIKLA Injection Adhesive VMU and an anchor rod with hexagon nut and washer of sizes M8, M10, M12, M16, M20, M24 and M30. The anchor rod (including nut and washer) is made of zinc plated steel or hot-dip galvanised steel (VMU-A or V-A), stainless steel 1.4401, 1.4404, 1.4571 or 1.4362 (VMU-A A4 or V-A A4) or high corrosion resistant steel 1.4529 or 1.4565 (VMU-A HCR or V-A HCR).

The anchor rod is anchored via the bond between anchor rod, chemical mortar and concrete.

An illustration of the product and intended use is given in Annex 1.

1.2 Intended use

The anchor is intended to be used for anchorages for which requirements for mechanical resistance and stability and safety in use in the sense of the Essential Requirements 1 and 4 of Council Directive 89/106 EEC shall be fulfilled and failure of anchorages made with these products would cause risk to human life and/or lead to considerable economic consequences. Safety in case of fire (Essential Requirement 2) is not covered in this European technical approval. The anchor is to be used only for anchorages subject to static or quasi-static loading in reinforced or unreinforced normal weight concrete of strength classes C20/25 at minimum and C50/60 at most according to EN 206:2000-12.

The anchor may be anchored in non-cracked concrete only.

The anchor may be installed in dry or wet concrete or also in flooded holes.

The anchor may be used in the following temperature ranges:

Temperature range I: -40 °C to +80 °C (max long term temperature +50 °C and
max short term temperature +80 °C)

Temperature range II: -40 °C to +120 °C (max long term temperature +72 °C and
max short term temperature +120 °C)

The provisions made in this European technical approval are based on an assumed working life of the anchors of 50 years. The indications given on the working life cannot be interpreted as a guarantee given by the producer, but are to be regarded only as a means for choosing the right products in relation to the expected economically reasonable working life of the works.

Zinc plated or hot-dip galvanised steel (VMU-A or V-A):

The anchor rod, nut and washer made of zinc plated or hot-dip galvanised steel may only be used in structures subject to dry internal conditions.

Stainless steel 1.4401, 1.4404, 1.4571 or 1.4362 (VMU-A A4 or V-A A4):

The anchor rod, nut and washer made of stainless steel may be used in structures subject to dry internal conditions and also in structures subject to external atmospheric exposure (including industrial and marine environment), or exposure in permanently damp internal conditions, if no particular aggressive conditions exist. Such particular aggressive conditions are e.g. permanent, alternating immersion in seawater or the splash zone of seawater, chloride atmosphere of indoor swimming pools or atmosphere with extreme chemical pollution (e.g. in desulphurization plants or road tunnels where de-icing materials are used).

High corrosion resistant steel 1.4529, 1.4565 (VMU-A HCR or V-A HCR):

The anchor rod, nut and washer made of high corrosion resistant steel may be used in structures subject to dry internal conditions and also in structures subject to external atmospheric exposure, in permanently damp internal conditions or in other particular aggressive conditions. Such particular aggressive conditions are e.g. permanent, alternating immersion in seawater or the splash zone of seawater, chloride atmosphere of indoor swimming pools or atmosphere with chemical pollution (e.g. in desulphurization plants or road tunnels where de-icing materials are used).

2 Characteristics of the product and methods of verification

2.1 Characteristics of the product

The anchor corresponds to the drawings and provisions given in Annexes 1 to 4. The characteristic material values, dimensions and tolerances of the anchor not indicated in Annexes 1 to 4 shall correspond to the respective values laid down in the technical documentation⁷ of this European technical approval.

The characteristic values for the design of anchorages are given in Annexes 5, 7 and 8.

Each mortar cartridge shall be marked with the imprint SIKLA Injection Adhesive VMU, processing notes, charge code, shelf-life, hazard code and curing- and processing time in accordance with Annex 4.

Each anchor rod shall be marked with the identifying mark of the producer, marking of anchorage depth and anchor size in accordance with Annex 2. The anchor rods for anchor size M12 have an additional marking of the anchor length in accordance with Annex 2. In addition, each anchor made of stainless steel 1.4401, 1.4404, 1.4571 or 1.4362 is marked with the letters "A4" and each anchor made of high corrosion resistant steel 1.4529 or 1.4565 is marked with the letters "HCR".

2.2 Methods of verification

The assessment of fitness of the anchor for the intended use in relation to the requirements for mechanical resistance and stability and safety in use in the sense of the Essential Requirements 1 and 4 has been made in accordance with the "Guideline for European technical approval of Metal Anchors for Use in Concrete", Part 1 "Anchors in general" and Part 5 "Bonded anchors", on the basis of Option 7.

In addition to the specific clauses relating to dangerous substances contained in this European technical approval, there may be other requirements applicable to the products falling within its scope (e.g. transposed European legislation and national laws, regulations and administrative provisions). In order to meet the provisions of the Construction Products Directive, these requirements need also to be complied with, when and where they apply.

⁷ The technical documentation of this European technical approval is deposited at the Deutsches Institut für Bautechnik and, as far as relevant for the tasks of the approved bodies involved in the attestation of conformity procedure, is handed over to the approved bodies.

3 Evaluation and attestation of conformity and CE marking

3.1 System of attestation of conformity

According to the decision 96/582/EG of the European Commission⁸ the system 2(i) (referred to as System 1) of attestation of conformity applies.

This system of attestation of conformity is defined as follows:

System 1: Certification of the conformity of the product by an approved certification body on the basis of:

(a) Tasks for the manufacturer:

- (1) factory production control;
- (2) further testing of samples taken at the factory by the manufacturer in accordance with a prescribed control plan;

(b) Tasks for the approved body:

- (3) initial type-testing of the product;
- (4) initial inspection of factory and of factory production control;
- (5) continuous surveillance, assessment and approval of factory production control.

Note: Approved bodies are also referred to as "notified bodies".

3.2 Responsibilities

3.2.1 Tasks for the manufacturer

3.2.1.1 Factory production control

The manufacturer shall exercise permanent internal control of production. All the elements, requirements and provisions adopted by the manufacturer shall be documented in a systematic manner in the form of written policies and procedures, including records of results performed. This production control system shall insure that the product is in conformity with this European technical approval.

The manufacturer may only use initial/raw/constituent materials stated in the technical documentation of this European technical approval.

The factory production control shall be in accordance with the control plan which is part of the technical documentation of this European technical approval. The control plan is laid down in the context of the factory production control system operated by the manufacturer and deposited with Deutsches Institut für Bautechnik.⁹

The results of factory production control shall be recorded and evaluated in accordance with the provisions of the control plan.

3.2.1.2 Other tasks for the manufacturer

The manufacturer shall, on the basis of a contract, involve a body which is approved for the tasks referred to in section 3.1 in the field of anchors in order to undertake the actions laid down in section 3.2.2. For this purpose, the control plan referred to in sections 3.2.1.1 and 3.2.2 shall be handed over by the manufacturer to the approved body involved.

The manufacturer shall make a declaration of conformity, stating that the construction product is in conformity with the provisions of this European technical approval.

⁸ Official Journal of the European Communities L 254 of 08.10.1996

⁹ The control plan is a confidential part of the European technical approval and only handed over to the approved body involved in the procedure of attestation of conformity. See section 3.2.2.

3.2.2 Tasks for the approved bodies

The approved body shall perform the

- initial type-testing of the product,
- initial inspection of factory and of factory production control,
- continuous surveillance, assessment and approval of factory production control in accordance with the provisions laid down in the control plan.

The approved body shall retain the essential points of its actions referred to above and state the results obtained and conclusions drawn in a written report.

The approved certification body involved by the manufacturer shall issue an EC certificate of conformity of the product stating the conformity with the provisions of this European technical approval.

In cases where the provisions of the European technical approval and its control plan are no longer fulfilled the certification body shall withdraw the certificate of conformity and inform Deutsches Institut für Bautechnik without delay.

3.3 CE marking

The CE marking shall be affixed on each packaging of the anchor. The letters "CE" shall be followed by the identification number of the approved certification body, where relevant, and be accompanied by the following additional information:

- the name and address of the holder of the approval (legal entity responsible for the manufacture),
- the last two digits of the year in which the CE marking was affixed,
- the number of the EC certificate of conformity for the product,
- the number of the European technical approval,
- the number of the guideline for European technical approval,
- use category (ETAG 001-1, Option 7),
- size.

4 Assumptions under which the fitness of the product for the intended use was favourably assessed

4.1 Manufacturing

The European technical approval is issued for the product on the basis of agreed data/information, deposited with Deutsches Institut für Bautechnik, which identifies the product that has been assessed and judged. Changes to the product or production process, which could result in this deposited data/information being incorrect, should be notified to Deutsches Institut für Bautechnik before the changes are introduced. Deutsches Institut für Bautechnik will decide whether or not such changes affect the approval and consequently the validity of the CE marking on the basis of the approval and if so whether further assessment or alterations to the approval shall be necessary.

4.2 Design of anchorages

The fitness of the anchor for the intended use is given under the following conditions:

The anchorages are designed in accordance with the "Guideline for European technical approval of Metal Anchors for Use in Concrete", Annex C, Method A, for bonded anchors under the responsibility of an engineer experienced in anchorages and concrete work.

For the verifications given below according to Annex C the following shall be observed:

- For the verification 'concrete cone failure' (clause 5.2.2.4, Annex C of the Guideline) $N_{Rk,c}$ shall be determined according to (1) and (2): The smaller of the values according to (1) and (2) is decisive.

(1) $N_{Rk,c}$ according to equation (5.2), Annex C of the Guideline

where: $N_{Rk,c}^0$ according to Annex 7

$S_{cr,N}$ according to Annex 7

$C_{cr,N}$ according to Annex 7

$\Psi_{ucr,N} = 1,0$

In special cases according to clause 5.2.2.4 g, Annex C of the Guideline the method given there is valid. However, the value $N_{Rk,c}^0$ shall be calculated according to the following equation:

$$N_{Rk,c}^0 = N_{Rk,c}^0 (\text{Annex 7}) \times \frac{h'_{ef}}{h_{ef}}$$

(2) $N_{Rk,c}$ according to equation (5.2), Annex C of the Guideline

where: $N_{Rk,c}^0 = 0,75 \times 15,5 \times h_{ef}^{1,5} \times f_{ck,cube}^{0,5}$

$S_{cr,N} = 3 h_{ef}$

$C_{cr,N} = 1,5 h_{ef}$

$\Psi_{ucr,N} = 1,0$

- For the verification 'splitting failure due to loading' (clause 5.2.2.6, Annex C of the Guideline) $N_{Rk,sp}$ shall be determined according to (3).

(3) $N_{Rk,sp}$ according to equation (5.3), Annex C of the Guideline

where: $N_{Rk,c}^0$ according to Annex 7

$S_{cr,sp}$ according to Annex 7

$C_{cr,sp}$ according to Annex 7

$\Psi_{ucr,N} = 1,0$

$\Psi_{h,sp} = 1,0$

- For the verification 'concrete pryout failure' (clause 5.2.3.3, Annex C of the Guideline) $N_{Rk,c}$ for equation (5.6), Annex C of the Guideline, shall be determined according to (1).

Verifiable calculation notes and drawings are prepared taking account of the loads to be anchored.

The position of the anchor is indicated on the design drawings (e.g. position of the anchor relative to reinforcement or to supports, etc.).

4.3 Installation of anchors

The fitness for use of the anchor can only be assumed if the anchor is installed as follows:

- anchor installation carried out by appropriately qualified personnel and under the supervision of the person responsible for technical matters of the site,
- commercial standard threaded rods, washers and hexagon nuts may also be used if the following requirements are fulfilled:
 - material, dimensions and mechanical properties of the metal parts according to the specifications given in Annex 2 and 3,
 - confirmation of material and mechanical properties of the metal parts by inspection certificate 3.1 according to EN 10204:2004, the documents should be stored,
 - marking of the threaded rod with the required embedment depth according to Annex 5. This may be done by the manufacturer of the rod or the person on jobsite.
- use of the anchor only as supplied by the manufacturer without exchanging the components of an anchor,
- anchor installation in accordance with the manufacturer's specifications and drawings using the tools indicated in the technical documentation of this European technical approval,
- checks before placing the anchor to ensure that the strength class of the concrete in which the anchor is to be placed is in the range given and is not lower than that of the concrete to which the characteristic loads apply,
- check of concrete being well compacted, e.g. without significant voids,
- keeping the effective anchorage depth,
- edge distance and spacing not less than the specified values without minus tolerances,
- positioning of the drill holes without damaging the reinforcement,
- in case of aborted drill hole: the drill hole shall be filled with mortar,
- cleaning the drill hole and installation in accordance with Annex 6,
- the anchor component installation temperature shall be at least +5 °C,
- the temperature of the concrete during installation and curing of the chemical mortar must not fall below -5 °C,
- the curing time according to Annex 3 shall be observed before the anchor may be loaded,
- after the curing time fixing the member to be anchored by using a calibrated torque wrench by not exceeding the torque moment given in Annex 5.

5 Indications to the manufacturer

5.1 Responsibility of the manufacturer

The manufacturer is responsible to ensure that the information on the specific conditions according to 1 and 2 including Annexes referred to as well as sections 4.2, 4.3 and 5.2 is given to those who are concerned. This information may be made by reproduction of the respective parts of the European technical approval. In addition all installation data shall be shown clearly on the package and/or on an enclosed instruction sheet, preferably using illustration(s).

The minimum data required are:

- drill bit diameter,
- hole depth,
- diameter of anchor rod,
- minimum effective anchorage depth,
- maximum thickness of the fixture,
- information on the installation procedure, including cleaning of the hole with the cleaning equipments, preferably by means of an illustration,
- anchor component installation temperature,
- ambient temperature of the concrete during installation of the anchor,
- admissible processing time (open time) of the mortar,
- curing time until the anchor may be loaded as a function of the ambient temperature in the concrete during installation,
- torque moment,
- identification of the manufacturing batch.

All data shall be presented in a clear and explicit form.

5.2 Packaging, transport and storage

The injection cartridges shall be protected against sun radiation and shall be stored according to the manufacture's installation instructions in dry condition at temperatures of at least +5 °C to not more than +25 °C.

Mortar cartridges with expired shelf life must no longer be used.

The anchor shall only be packaged and supplied as a complete unit. Mortar cartridges are packed separately from anchor rods, nuts and washers.

Georg Feistel
Head of Department

beglaubigt
Baderschneider

Injection System VMU

Sealing cap



Mortar cartridge

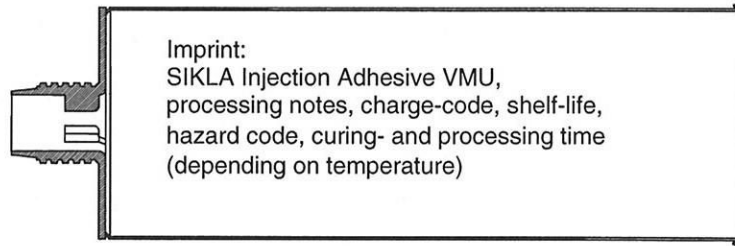

Static mixer

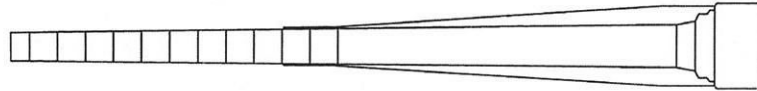

Threaded rod

VMU-A, or
commercial
threaded rod

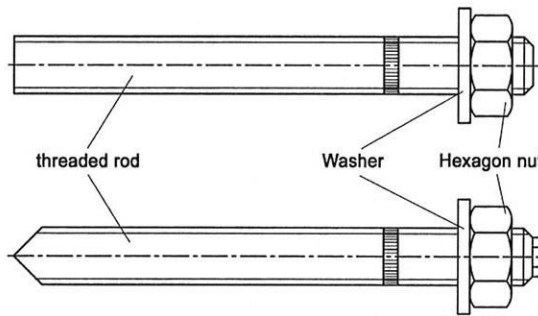

V-A

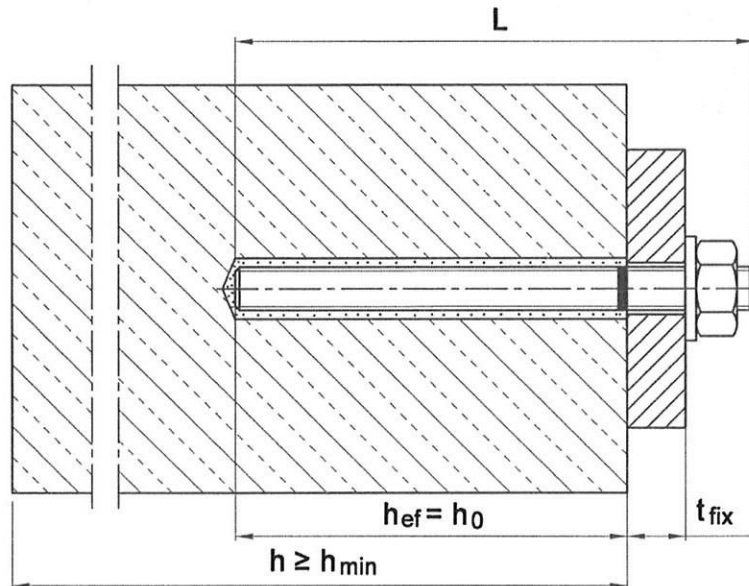

Use category: Non-cracked concrete only; installation in dry or wet concrete, or flooded hole

Temperature range: -40°C to +80°C (max long term temperature +50°C and max short term temperature +80°C)
-40°C to +120°C (max long term temperature +72°C and max short term temperature +120°C)

SIKLA Injection System VMU for concrete

Annex 1

of European
technical approval

Product and intended use

ETA-10/0261

Threaded rod

VMU-A, or commercial threaded rod

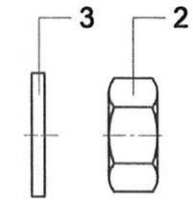
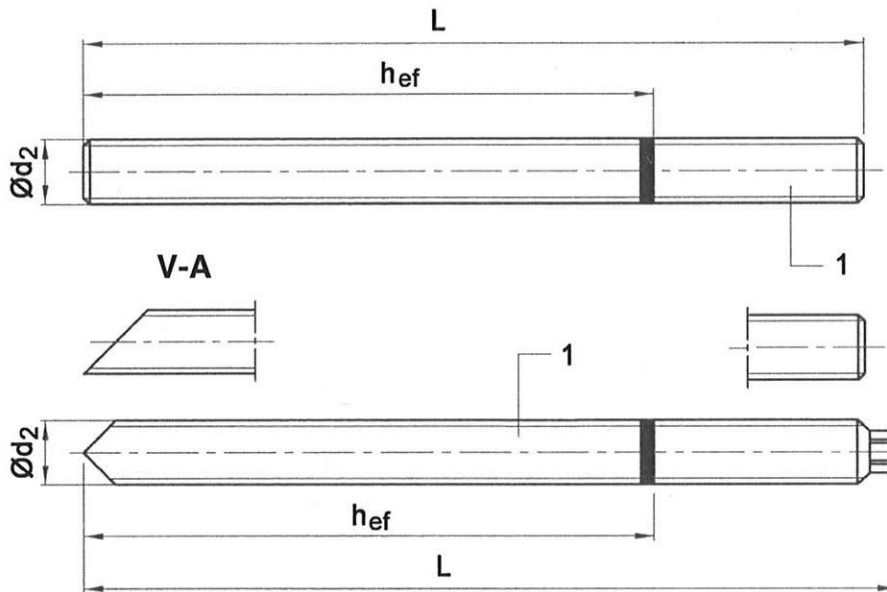

Marking: e.g.: \diamond H M12

\diamond Identifying mark of manufacturing plant
additional marking of lengths e.g. for anchor size M12

H marking of length (Table Annex 2)

M12 Size of thread

\diamond M12-8
-8 additional marking of steel grade 8.8

\diamond M12 A4
A4 additional marking of stainless steel A4

\diamond M12 HCR
HCR additional marking of high corrosion resistant steel

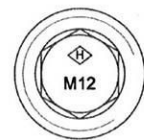

Marking of length	D	E	F	G	H	I	J	K
Length of anchor min \geq	76.2	88.9	101.6	114.3	127.0	139.7	152.4	165.1
Length of anchor max $<$	88.9	101.6	114.3	127.0	139.7	152.4	165.1	177.8

Marking of length	L	M	N	O	P	Q	R	S
Length of anchor min \geq	177.8	190.5	203.2	215.9	228.6	241.3	254.0	279.4
Length of anchor max $<$	190.5	203.2	215.9	228.6	241.3	254.0	279.4	304.8

Marking of length	T	U	V	W	X	Y	Z
Length of anchor min \geq	304.8	330.2	355.6	381.0	406.4	431.8	457.2
Length of anchor max $<$	330.2	355.6	381.0	406.4	431.8	457.2	483.0

Table 1: Anchor dimensions

Size		M8	M10	M12	M16	M20	M24	M30
$\varnothing d_2$	[mm]	8	10	12	16	20	24	30
L	[mm]	≥ 90	≥ 101	≥ 124	≥ 143	≥ 190	≥ 235	≥ 300

SIKLA Injection System VMU for concrete

Anchor dimensions

Annex 2

of European technical approval

ETA-10/0261

Table 2: Materials

Part	Designation	Steel, electroplated $\geq 5 \mu\text{m}$ acc. to EN ISO 4042	Steel, hot-dip galvanised $\geq 40 \mu\text{m}$ acc. to EN ISO 1461
1	Threaded rod	Steel, Property class 5.8, 8.8, acc. to EN ISO 898-1	Steel, Property class 5.8, 8.8, acc. to EN ISO 898-1
2	Hexagon nut according to DIN 934	Property class 8 acc. to EN 20898-2	Property class 8 acc. to EN 20898-2
3	Washer	Steel	Steel
4	Mortar cartridge	Vinylester resin, styrene free	

Part	Designation	Stainless steel A4	High corrosion resistant steel (HCR)
1	Threaded rod	Stainless steel, 1.4401, 1.4404, 1.4571, 1.4362, EN 10088, $\leq M24$: Property class 70 > M24: Property class 50, acc. to EN ISO 3506	High corrosion resistant steel, 1.4529, 1.4565, EN 10088, $\leq M24$: Property class 70 > M24: Property class 50, acc. to EN ISO 3506
2	Hexagon nut according to DIN 934	Stainless steel, 1.4401, 1.4404, 1.4571, 1.4362, EN 10088, $\leq M24$: Property class 70 > M24: Property class 50, acc. to EN ISO 3506	High corrosion resistant steel, 1.4529, 1.4565, EN 10088, $\leq M24$: Property class 70 > M24: Property class 50, acc. to EN ISO 3506
3	Washer	Stainless steel, 1.4401, 1.4404, 1.4571, 1.4362, EN 10088	High corrosion resistant steel, 1.4529, 1.4565, EN 10088
4	Mortar cartridge	Vinylester resin, styrene free	

Requirements of commercial threaded rods:

- Materials, dimensions and mechanical properties (Table 2)
- Inspection certificate 3.1 acc. to EN 10204
- Place marking of embedment depth

Table 3: Processing and curing time

Temperature [°C] in the drill hole	Maximum processing time	Minimum curing time	
		dry concrete	wet concrete
+ 40 °C	1.4 min	15 min	30 min
+ 35 °C	2 min	20 min	40 min
+ 30 °C	4 min	25 min	50 min
+ 20 °C	6 min	45 min	1:30 h
+ 10 °C	12 min	1:20 h	2:40 h
+ 5 °C	20 min	2:00 h	4:00 h
0 °C	45 min	3:00 h	6:00 h
- 5 °C	1:30 h	5:30 h	11:00 h ¹⁾

¹⁾ It must be ensured that icing does not occur in the drill hole. The hole must be drilled and cleaned directly prior to the installation of the anchor.

SIKLA Injection System VMU for concrete	Annex 3
Material, Processing and curing times	of European technical approval
	ETA-10/0261

Mortar cartridges VMU
(Various container sizes)

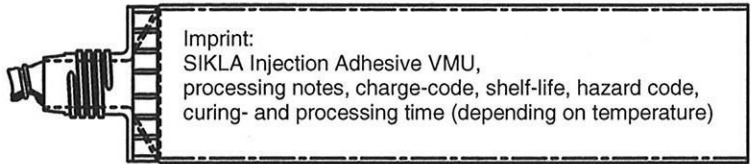

Foil tube

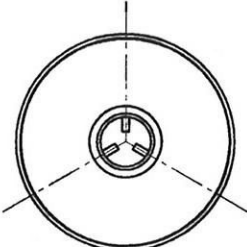
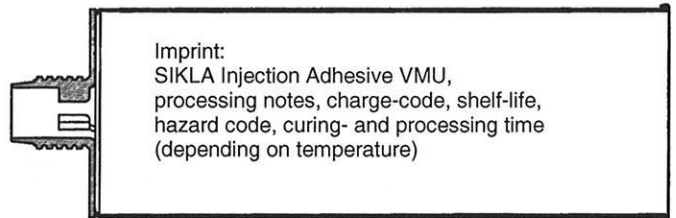

Coaxial

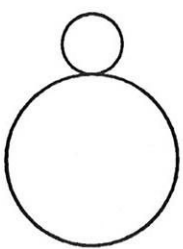
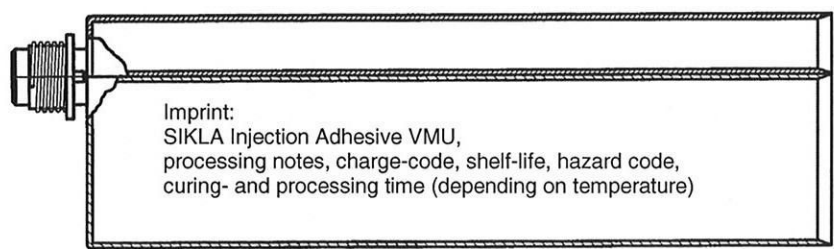

Side-by-side

Sealing cap



Static mixer

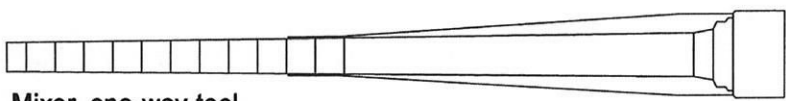

Mixer, one-way tool,
must be changed in case of working interruption

SIKLA Injection System VMU for concrete

Annex 4
of European
technical approval

Mortar cartridges

ETA-10/0261

Table 4: Installation parameters

Anchor size			M8	M10	M12	M16	M20	M24	M30
Nominal diameter of drill hole	$d_0 =$	[mm]	10	12	14	18	22	26	32
Depth of drill hole	$h_0 \geq$	[mm]	80	90	110	125	170	210	270
Diameter of clearance hole in the fixture	$d_f \leq$	[mm]	9	12	14	18	22	26	33
Diameter of steel brush	$D \geq$	[mm]	11	13	15	19	23	27	34
Torque moment	$T_{inst} \leq$	[Nm]	10	20	40	60	120	150	300
Effective anchorage depth	$h_{ef} =$	[mm]	80	90	110	125	170	210	270
Minimum thickness of concrete	$h_{min} =$	[mm]	100	130	160	200	220	280	350
Reduced minimum thickness of concrete	$h_{min,red} =$	[mm]	-	120	140	160	-	-	-
Minimum spacing	$s_{min} =$	[mm]	40	45	55	65	85	105	135
Minimum edge distance	$c_{min} =$	[mm]	40	45	55	65	85	105	135

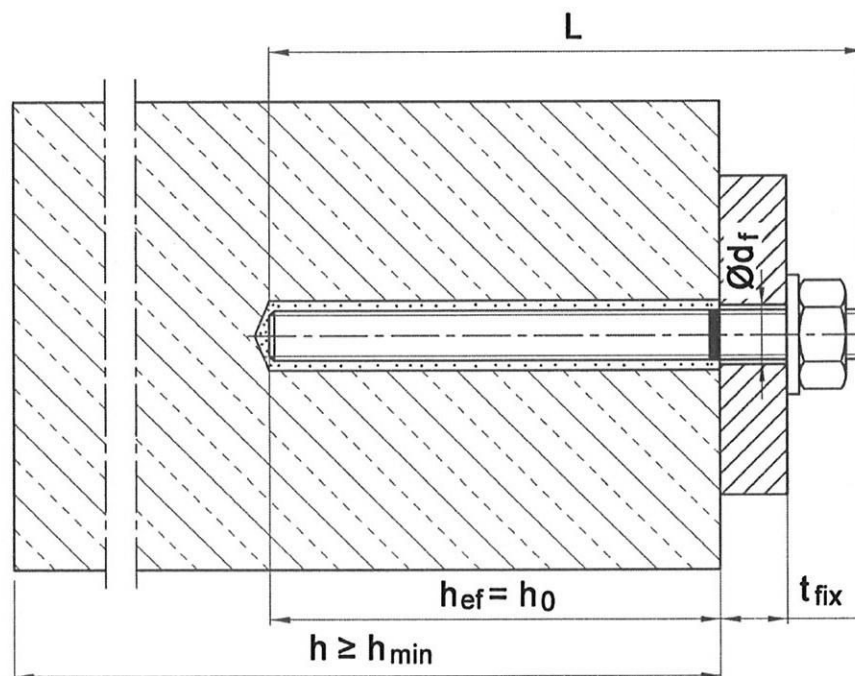
SIKLA steel brush**SIKLA Injection System VMU for concrete****Installation parameters,
Cleaning of drill hole****Annex 5**of European
technical approval**ETA-10/0261**

Installation Instructions

1		<p>Use Hammer drill or air drill with drill bit and depth gauge. Drill perpendicular to concrete surface.</p> <p>Drill hole must be cleaned directly prior to installation of the anchor.</p>
2a		<p>VMU M8 - M16: Blow out drill hole from the bottom with SIKLA Blow-out Pump VM-AP at least two times. The Extension Tube with reduced diameter must be added to the Blow-out Pump for the diameter M8.</p>
2b		<p>VMU M20 – M30: Connect SIKLA Air Blower VM-ABP to compressed air (min. 6 bar, oil-free). Open air valve and blow out drill hole along the entire depth with back and forth motion at least two times.</p>
3		<p>Check diameter of SIKLA Wire Brush RB. If Wire Brush can be pushed into the drill hole without any resistance, it must be replaced. Chuck Brush into drill machine. Turn on drill machine. Brush drill hole back and forth along the entire drill hole depth at least two times while rotated by drill machine.</p>
4a		<p>VMU M8 - M16: Blow out drill hole from the bottom with SIKLA Blow-out Pump VM-AP at least two times. The Extension Tube with reduced diameter must be added to the Blow-out Pump for the diameter M8.</p>
4b		<p>VMU M20 – M30: Connect SIKLA Air Blower VM-ABP to compressed air (min. 6 bar, oil-free). Open air valve and blow out drill hole along the entire depth with back and forth motion at least two times.</p>
5		<p>Check expiration date on SIKLA VMU cartridge. Never use when expired. Remove cap from VMU cartridge. When using VMU 300 cut off foil tube sealing. Screw Mixer Nozzle VM-X on cartridge. When using a new cartridge always use a new Mixer Nozzle. Never use cartridge without Mixer Nozzle and never use Mixer Nozzle without helix inside.</p>
6		<p>Insert cartridge in Dispenser. Prior to injection discard mortar (at least 2 full strokes or a line of 10 cm) until it shows a consistent grey colour. Never use this mortar.</p>
7		<p>Prior to injection check if Mixer Nozzle VM-X reaches the bottom of the drill hole. If it does not reach the bottom, plug Mixer Extension VM-XE onto Mixer Nozzle in order to properly fill the drill hole. Fill cleaned drill hole with a sufficient quantity of injection mortar. Start from the bottom of the drill hole and work out to avoid trapping air pockets.</p>
8		<p>Insert the threaded rod by hand, rotating slightly up to the full embedment depth as marked on the anchor rod. The anchor rod is properly set when excess mortar seeps from the hole. If the hole is not completely filled, pull out anchor rod, let mortar cure, drill out hole and start again from No. 2.</p>
9		<p>Follow minimum curing time shown in Table 5. During curing time threaded rod must not be moved or loaded.</p>
10		<p>Remove excess mortar.</p>
11		<p>The fixture can be mounted after curing time. Apply installation torque T_{inst} according to Table 4 or by using torque wrench.</p>

SIKLA Injection System VMU for concrete

Installation Instructions

Annex 6

of European technical approval

ETA-10/0261

Table 5: Design method A
Characteristic values for tension loads

Anchor size			M8	M10	M12	M16	M20	M24	M30	
Steel failure										
Characteristic resistance, Property class 5.8 acc. to EN ISO 898-1	$N_{Rk,s}$	[kN]	18	29	42	78	123	176	280	
Characteristic resistance, Property class 8.8 acc. to EN ISO 898-1	$N_{Rk,s}$	[kN]	29	46	67	126	196	282	449	
Partial safety factor	$\gamma_{Ms}^{1)}$	[-]	1.5							
Characteristic resistance, Property class 70 ($\leq M24$) und 50 ($>M24$)	$N_{Rk,s}$	[kN]	26	41	59	110	172	247	280	
Partial safety factor VMU-A, V-A	$\gamma_{Ms}^{1)}$	[-]	1.5							2.4
Partial safety factor commercial threaded rod	$\gamma_{Ms}^{1)}$	[-]	1.87							2.86
Pullout and concrete cone failure										
Effective anchorage depth	h_{ef}	[mm]	80	90	110	125	170	210	270	
Non-cracked concrete C20/25 (50°C / 80°C) ⁴⁾	$N_{Rk,c}^0 = N_{Rk,p}$	[kN]	16	25	35	50	95	115	170	
Non-cracked concrete C20/25 (72°C / 120°C) ⁴⁾	$N_{Rk,c}^0 = N_{Rk,p}$	[kN]	12	16	25	40	60	75	115	
Increasing factors for non-cracked concrete ψ_c	C30/37	[-]	1.12							
	C40/50	[-]	1.23							
	C50/60	[-]	1.30							
Characteristic edge distance	$c_{cr,N}$	[mm]	80	90	110	125	170	210	270	
Characteristic spacing	$s_{cr,N}$	[mm]	160	180	220	250	340	420	540	
Partial safety factor	$\gamma_{Mc} = \gamma_{Mp}^{1)}$	[-]	1.5 ²⁾				1.5 / 1.8 ³⁾		1.5 ²⁾	
Splitting failure										
Minimum thickness of concrete	h_{min}	[mm]	100	130	160	200	220	280	350	
Edge distance	$c_{cr,sp}$	[mm]	80	90	110	125	170	210	270	
Spacing	$s_{cr,sp}$	[mm]	160	180	220	250	340	420	540	
Reduced minimum thickness of concrete	$h_{min,red}$	[mm]	-	120	140	160	-	-	-	
Edge distance	$c_{cr,sp}$	[mm]	-	145	180	200	-	-	-	
Spacing	$s_{cr,sp}$	[mm]	-	290	360	400	-	-	-	
Partial safety factor	$\gamma_{Msp}^{1)}$	[-]	1.5 ²⁾				1.5 / 1.8 ³⁾		1.5 ²⁾	

¹⁾ In absence of other national regulations

²⁾ The partial safety factor $\gamma_2 = 1.0$ is included

³⁾ $\gamma_{Mc} = \gamma_{Mp} = 1.5$ in dry and wet concrete, $\gamma_{Mc} = \gamma_{Mp} = 1.8$ in flooded hole

⁴⁾ Maximum long term temperature / maximum short term temperature

Table 6: Displacements under tension loads

Anchor size			M8	M10	M12	M16	M20	M24	M30
Tension load	N	[kN]	7.6	11.9	16.7	23.8	42.9	54.8	81
Displacement	δ_{N0}	[mm]	0.1	0.1	0.1	0.1	0.1	0.3	0.5
	$\delta_{N\infty}$	[mm]	0.2					0.6	1.0

SIKLA Injection System VMU for concrete

Design Method A
Characteristic values for tension loads,
Displacements under tension loads

Annex 7

of European
technical approval

ETA-10/0261

Table 7: Design method A
Characteristic values for shear loads

Anchor size			M8	M10	M12	M16	M20	M24	M30		
Steel failure without lever arm											
Characteristic resistance	Property class 5.8	$V_{Rk,s}$	[kN]	9	15	21	39	61	88	140	
	Property class 8.8	$V_{Rk,s}$	[kN]	15	23	34	63	98	141	224	
Partial safety factor		$\gamma_{Ms}^{1)}$	[-]	1.25							
Characteristic resistance, Property class 70 ($\leq M24$) und 50 ($>M24$)		$V_{Rk,s}$	[kN]	13	20	30	55	86	123	140	
Partial safety factor VMU-A, V-A		$\gamma_{Ms}^{1)}$	[-]	1.25							2.0
Partial safety factor commercial threaded rod		$\gamma_{Ms}^{1)}$	[-]	1.56							2.38
Steel failure with lever arm											
Characteristic bending moments	Property class 5.8	$M_{Rk,s}^0$	[Nm]	19	37	65	165	325	561	1124	
	Property class 8.8	$M_{Rk,s}^0$	[Nm]	30	60	105	266	519	898	1799	
Partial safety factor		$\gamma_{Ms}^{1)}$	[-]	1.25							
Characteristic bending moments, Property class 70 ($\leq M24$) und 50 ($>M24$)		$M_{Rk,s}^0$	[Nm]	26	52	92	233	454	784	1123	
Partial safety factor VMU-A, V-A		$\gamma_{Ms}^{1)}$	[-]	1.25							2.0
Partial safety factor commercial threaded rod		$\gamma_{Ms}^{1)}$	[-]	1.56							2.38
Concrete pryout failure											
Factor in equation (5.6) ETAG Annex C, 5.2.3.3		k	[-]	2							
Partial safety factor		$\gamma_{Mc}^{1)}$	[-]	1.5 ²⁾							
Concrete edge failure											
Effective length of anchor in shear loading		l_f	[mm]	80	90	110	125	170	210	270	
Diameter of anchor		d_{nom}	[mm]	10	12	14	18	22	26	32	
Partial safety factor		$\gamma_{Mc}^{1)}$	[-]	1.5 ²⁾							

¹⁾ In absence of other national regulations

²⁾ The partial safety factor $\gamma_2 = 1.0$ is included

Table 8: Displacements under shear loads

Anchor size			M8	M10	M12	M16	M20	M24	M30	
Shear load, Property class 5.8		V	[kN]	5.1	8.3	12.1	22.4	34.9	50.3	80
Displacement	δ_{v0}	[mm]	0.5	0.4	0.8	1.2	1.4	1.4	1.4	
	$\delta_{v\infty}$	[mm]	0.8	0.7	1.2	1.8	2.1	2.1	2.1	
Shear load, Property class 8.8		V	[kN]	8.6	13.2	19.3	35.9	56	81	128
Displacement	δ_{v0}	[mm]	0.8	0.7	1.2	1.9	2.2	2.2	2.2	
	$\delta_{v\infty}$	[mm]	1.3	1.1	1.9	2.8	3.4	3.4	3.4	
Shear load, Property class 70 ($\leq M24$) und 50 ($>M24$)		V	[kN]	7.3	11.6	16.9	31.4	49	70	50
Displacement	δ_{v0}	[mm]	0.7	0.6	1.1	1.7	2.0	2.0	0.8	
	$\delta_{v\infty}$	[mm]	1.0	0.9	1.7	2.6	2.9	2.9	1.3	

SIKLA Injection System VMU for concrete

Design Method A
Characteristic values for shear loads,
Displacements under shear loads

Annex 8

of European
technical approval

ETA-10/0261