

European Technical Approval ETA-11/0163

English translation prepared by DIBt - Original version in German language

Handelsbezeichnung
Trade name

Einschlaganker SAK
Drop in anchor SAK

Zulassungsinhaber
Holder of approval

KALM
Befestigungssysteme GmbH
Marie-Curie-Straße 5
67661 Kaiserslautern
DEUTSCHLAND

Zulassungsgegenstand
und Verwendungszweck
*Generic type and use
of construction product*

Wegkontrolliert spreizender Dübel aus verzinktem Stahl in den Größen
M8, M10, M12 und M16 zur Verankerung im ungerissenen Beton
*Deformation-controlled expansion anchors made of galvanised steel in
sizes of M8, M10, M12 and M16 for use in non-cracked concrete*

Geltungsdauer:
Validity: vom
from
bis
to

12 May 2011
12 May 2016

Herstellwerk
Manufacturing plant

Kalm Befestigungssysteme GmbH, Kaiserslautern

Diese Zulassung umfasst
This Approval contains

12 Seiten einschließlich 5 Anhänge
12 pages including 5 annexes

I LEGAL BASES AND GENERAL CONDITIONS

- 1 This European technical approval is issued by Deutsches Institut für Bautechnik in accordance with:
 - Council Directive 89/106/EEC of 21 December 1988 on the approximation of laws, regulations and administrative provisions of Member States relating to construction products¹, modified by Council Directive 93/68/EEC² and Regulation (EC) N° 1882/2003 of the European Parliament and of the Council³;
 - Gesetz über das In-Verkehr-Bringen von und den freien Warenverkehr mit Bauprodukten zur Umsetzung der Richtlinie 89/106/EWG des Rates vom 21. Dezember 1988 zur Angleichung der Rechts- und Verwaltungsvorschriften der Mitgliedstaaten über Bauprodukte und anderer Rechtsakte der Europäischen Gemeinschaften (Bauproduktengesetz - BauPG) vom 28. April 1998⁴, as amended by law of 31 October 2006⁵;
 - Common Procedural Rules for Requesting, Preparing and the Granting of European technical approvals set out in the Annex to Commission Decision 94/23/EC⁶;
 - Guideline for European technical approval of "Metal anchors for use in concrete - Part 4: Deformation controlled expansion anchors", ETAG 001-04.
- 2 Deutsches Institut für Bautechnik is authorized to check whether the provisions of this European technical approval are met. Checking may take place in the manufacturing plant. Nevertheless, the responsibility for the conformity of the products to the European technical approval and for their fitness for the intended use remains with the holder of the European technical approval.
- 3 This European technical approval is not to be transferred to manufacturers or agents of manufacturers other than those indicated on page 1, or manufacturing plants other than those indicated on page 1 of this European technical approval.
- 4 This European technical approval may be withdrawn by Deutsches Institut für Bautechnik, in particular pursuant to information by the Commission according to Article 5(1) of Council Directive 89/106/EEC.
- 5 Reproduction of this European technical approval including transmission by electronic means shall be in full. However, partial reproduction can be made with the written consent of Deutsches Institut für Bautechnik. In this case partial reproduction has to be designated as such. Texts and drawings of advertising brochures shall not contradict or misuse the European technical approval.
- 6 The European technical approval is issued by the approval body in its official language. This version corresponds fully to the version circulated within EOTA. Translations into other languages have to be designated as such.

¹ Official Journal of the European Communities L 40, 11 February 1989, p. 12
² Official Journal of the European Communities L 220, 30 August 1993, p. 1
³ Official Journal of the European Union L 284, 31 October 2003, p. 25
⁴ *Bundesgesetzblatt Teil I* 1998, p. 812
⁵ *Bundesgesetzblatt Teil I* 2006, p. 2407, 2416
⁶ Official Journal of the European Communities L 17, 20 January 1994, p. 34

II SPECIFIC CONDITIONS OF THE EUROPEAN TECHNICAL APPROVAL

1 Definition of product and intended use

1.1 Definition of the construction product

The KALM Drop-in anchor SAK in the sizes M8, M10, M12 and M16 is an anchor made of zinc-plated steel which is placed into a drilled hole and anchored by deformation-controlled expansion.

The product (types, sizes) and an illustration of the installed anchor are given in Annex 1.

The fixture shall be anchored with a fastening screw or threaded rod according to Annex 2.

1.2 Intended use

The anchor is intended to be used for anchorages for which requirements for mechanical resistance and stability and safety in use in the sense of the Essential Requirements 1 and 4 of Council Directive 89/106 EEC shall be fulfilled and failure of anchorages made with these products would cause risk to human life and/or lead to considerable economic consequences. The anchor is to be used only for anchorages subject to static or quasi-static loading in reinforced or unreinforced normal weight concrete of strength classes C20/25 at minimum and C50/60 at most according to EN 206-1:2000-12.

The anchor may be anchored in non-cracked concrete only.

The anchor made of zinc-plated steel may only be used in structures subject to dry internal conditions.

The provisions made in this European technical Approval are based on an assumed intended working life of the anchor of 50 years. The indications given on the working life cannot be interpreted as a guarantee given by the producer, but are to be regarded only as a means for choosing the right products in relation to the expected economically reasonable working life of the works.

2 Characteristics of product and methods of verification

2.1 Characteristics of product

The anchor corresponds to the drawings and provisions given in Annex 2. The characteristic material values, dimensions and tolerances of the anchor not indicated in Annex 2 shall correspond to the respective values laid down in the technical documentation⁷ of this European technical approval.

The characteristic anchor values for the design of anchorages are given in Annexes 3 to 4.

Each anchor is marked according to Annex 1 with the identifying mark of manufacturing plant and the thread size.

The anchor shall only be packaged and supplied as a complete unit.

⁷ The technical documentation of this European technical approval is deposited at the Deutsches Institut für Bautechnik and, as far as relevant for the tasks of the approved bodies involved in the attestation of conformity procedure, is handed over to the approved bodies.

2.2 Methods of verification

The assessment of fitness of the anchor for the intended use in relation to the requirements for mechanical resistance and stability and safety in use in the sense of the Essential Requirements 1 and 4 has been made in accordance with the "Guideline for European technical approval of Metal Anchors for Use in Concrete", Part 1 "Anchors in general" and Part 4 "Deformation-controlled expansion anchors" on the basis of Option 7.

In addition to the specific clauses relating to dangerous substances contained in this European technical approval, there may be other requirements applicable to the products falling within its scope (e.g. transposed European legislation and national laws, regulations and administrative provisions). In order to meet the provisions of the Construction Products Directive, these requirements need also to be complied with, when and where they apply.

3 Evaluation and attestation of conformity and CE marking

3.1 System of attestation of conformity

According to the decision 96/582/EG of the European Commission⁸ the system 2(i) (referred to as System 1) of attestation of conformity applies.

This system of attestation of conformity is defined as follows:

System 1: Certification of the conformity of the product by an approved certification body on the basis of:

- (a) Tasks for the manufacturer:
 - (1) factory production control;
 - (2) further testing of samples taken at the factory by the manufacturer in accordance with a prescribed test plan;
- (b) Tasks for the approved body:
 - (3) initial type-testing of the product;
 - (4) initial inspection of factory and of factory production control;
 - (5) continuous surveillance, assessment and approval of factory production control.

Note: Approved bodies are also referred to as "notified bodies".

3.2 Responsibilities

3.2.1 Tasks of the manufacturer

3.2.1.1 Factory production control

The manufacturer shall exercise permanent internal control of production. All the elements, requirements and provisions adopted by the manufacturer shall be documented in a systematic manner in the form of written policies and procedures, including records of results performed. This production control system shall insure that the product is in conformity with this European technical approval.

The manufacturer may only use initial / raw / constituent materials stated in the technical documentation of this European technical approval.

⁸ Official Journal of the European Communities L 254 of 08.10.1996

The factory production control shall be in accordance with the control plan which is part of the technical documentation of this European technical approval. The control plan is laid down in the context of the factory production control system operated by the manufacturer and deposited at Deutsches Institut für Bautechnik.⁹

The results of factory production control shall be recorded and evaluated in accordance with the provisions of the control plan.

3.2.1.2 Other tasks of manufacturer

The manufacturer shall, on the basis of a contract, involve a body which is approved for the tasks referred to in section 3.1 in the field of anchors in order to undertake the actions laid down in section 3.2.2. For this purpose, the control plan referred to in sections 3.2.1.1 and 3.2.2 shall be handed over by the manufacturer to the approved body involved.

The manufacturer shall make a declaration of conformity, stating that the construction product is in conformity with the provisions of this European technical approval.

3.2.2 Tasks of approved bodies

The approved body shall perform the following tasks in accordance with the provisions laid down in the control plan:

- initial type-testing of the product,
- initial inspection of factory and of factory production control,
- continuous surveillance, assessment and approval of factory production control.

The approved body shall retain the essential points of its actions referred to above and state the results obtained and conclusions drawn in a written report.

The approved certification body involved by the manufacturer shall issue an EC certificate of conformity of the product stating the conformity with the provisions of this European technical approval.

In cases where the provisions of the European technical approval and its control plan are no longer fulfilled the certification body shall withdraw the certificate of conformity and inform Deutsches Institut für Bautechnik without delay.

3.3 CE marking

The CE marking shall be affixed on each packaging of anchors. The letters "CE" shall be followed by the identification number of the approved certification body, where relevant, and be accompanied by the following additional information:

- the name and address of the producer (legal entity responsible for the manufacturer),
- the last two digits of the year in which the CE marking was affixed,
- the number of the EC certificate of conformity for the product,
- the number of the European technical approval,
- the number of the guideline for European technical approval,
- use category (ETAG 001-1, Option 7),
- size.

⁹ The control plan is a confidential part of the documentation of the European technical approval, but not published together with the European technical approval and only handed over to the approved body involved in the procedure of attestation of conformity.
See section 3.2.2.

4 Assumptions under which the fitness of the product for the intended use was favourably assessed

4.1 Manufacturing

The European technical approval is issued for the product on the basis of agreed data/information, deposited with Deutsches Institut für Bautechnik, which identifies the product that has been assessed and judged. Changes to the product or production process, which could result in this deposited data/information being incorrect, should be notified to Deutsches Institut für Bautechnik before the changes are introduced. Deutsches Institut für Bautechnik will decide whether or not such changes affect the European technical approval and consequently the validity of the CE marking on the basis of the European technical approval and if so whether further assessment or alterations to the European technical approval shall be necessary.

4.2 Design of anchorages

The fitness of the anchor for the intended use is given under the following conditions:

The anchorages are designed in accordance with the "Guideline for European technical approval of Metal Anchors for Use in Concrete", Annex C, Method A, under the responsibility of an engineer experienced in anchorages and concrete work.

Verifiable calculation notes and drawings are prepared taking account of the loads to be anchored.

The position of the anchor is indicated on the design drawings (e.g. position of the anchor relative to reinforcement or to supports).

The strength class and the length of the fastening screw or threaded rod shall be defined by the designing engineer. The choice of the length shall account for the available thread length, the minimum screwing depth, the thickness of fixture and tolerances of member and fixture. The strength class and the minimum screwing depth of the fastening screw or threaded rod shall be met the requirements according to Annex 2.

4.3 Installation of anchors

The fitness for use of the anchor can only be assumed if the anchor is installed as follows:

- Anchor installation carried out by appropriately qualified personnel and under the supervision of the person responsible for technical matters of the site.
- Use of the anchor only as supplied by the manufacturer without exchanging the components of an anchor.
- Anchor installation in accordance with the manufacturer's specifications and drawings and using the appropriate tools;
- Checks before placing the anchor to ensure that the strength class of the concrete in which the anchor is to be placed is in the range given and is not lower than that of the concrete to which the characteristic loads apply.
- Check of concrete being well compacted, e.g. without significant voids.
- Keeping of the edge distance and spacing to the specified values without minus tolerances.
- Positioning of the drill holes without damaging the reinforcement.
- In case of aborted hole: new drilling at a minimum distance away of twice the depth of the aborted hole or smaller distance if the aborted drill hole is filled with high strength mortar and if under shear or oblique tension load it is not in the direction of load application.
- Clearing of the hole of drilling dust according to Annex 5.
- Anchor installation such that the effective setting depth is complied with. This compliance is ensured, if the anchor is completely set into the drill hole.

- Anchor expansion by impact on the cone using the manual setting tools given in Annex 1. The anchor is properly set if the stop of the setting tool reaches the expansion sleeve.
- The fastening screw or threaded rod shall correspond to the requirements given in Annex 2.
- Installation torque moments are not required for functioning of the anchor. However, the torque moments given in Annex 2 must not be exceeded.

5 Responsibility of the manufacturer

It is in the responsibility of the manufacturer to ensure that the information on the specific conditions according to 1 and 2 including Annexes referred to as well as sections 4.2 and 4.3 is given to those who are concerned. This information may be made by reproduction of the respective parts of the European technical approval. In addition all installation data shall be shown clearly on the package and/or on an enclosed instruction sheet, preferably using illustration(s).

The minimum data required are:

- drill bit diameter,
- thread diameter,
- minimum effective anchorage depth,
- available thread length and minimum screwing depth of the fastening screw
- minimum hole depth,
- torque moment,
- information on the installation procedure, including cleaning of the hole, preferably by means of an illustration,
- reference to any special installation equipment needed,
- identification of the manufacturing batch.

All data shall be presented in a clear and explicit form.

Georg Feistel
Head of Department

beglaubigt:
Tempel

Drop-In Anchor SAK

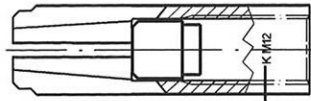

Identifying mark of manufacturing plant K
 Size of thread M...
 Example: KM12

Marking

Intended use

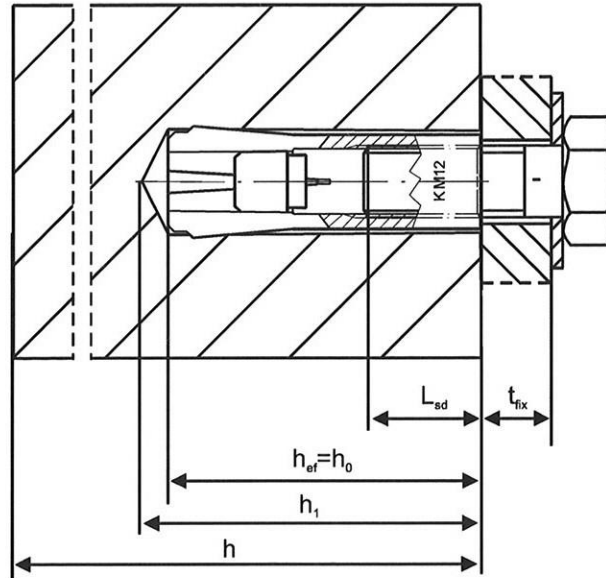

Description

Sleeve

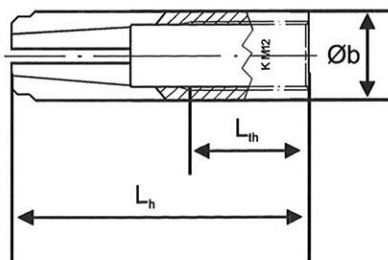

Cone

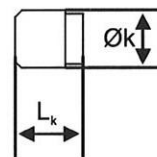

Setting tool

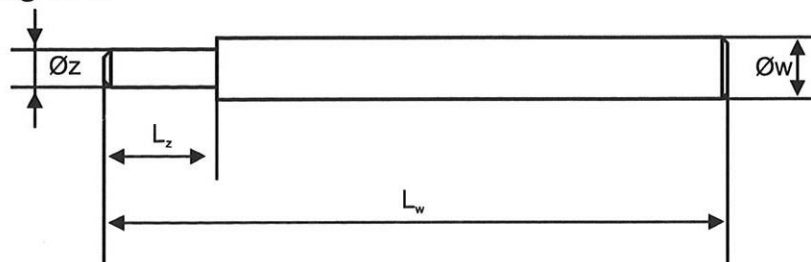

K-A-L-M Drop In Anchor SAK

Product and intended use

Annex 1

of the European
 technical approval
 ETA-11/0163

Table 1: Dimensions

Drop In Anchor	thread	L_h	$\varnothing b$	L_{th}	$\varnothing k$	L_k
M8	M8	30	10	13	6,5	11
M10	M10	40	12	15	8,1	14
M12	M12	50	15	18	10,0	18
M16	M16	65	20	23	13,8	25

Setting tool	L_w	$\varnothing w$	L_z	$\varnothing z$
M8	170	10	17	6
M10	170	12	23	8
M12	170	15	26	10
M16	170	20	40	13

Table 2: Materials

Part	Designation	Steel, zinc plated $\geq 5 \mu\text{m}$ plated acc. to DIN EN ISO 4042
1	Sleeve	Steel, Property class 5.8, acc to DIN EN ISO 898-1
2	Cone	Steel, Property class 5.8, acc to DIN EN ISO 898-1

Table 3: Installation parameters

Anchor size			M8	M10	M12	M16
Nominal drill hole diameter	d_0	[mm]	10	12	15	20
Cutting drill diameter	$d_{cut} \leq$	[mm]	10,45	12,50	15,50	20,55
Depth of drill hole	h_1	[mm]	33	44	54	71
Setting depth = effective anchoring depth	h_{ef}	[mm]	30	40	50	65
Length of thread	L_{th}	[mm]	16	18	20	27
Minimum screwing depth	$L_{sd,min}$	[mm]	9	11	13	17
Recommended torque moment	$T_{inst} \leq$	[Nm]	8	15	35	60
Diameter of clearance hole in the fixture	$d_f \leq$	[mm]	9	11	13	18
Minimum spacing	s_{min}	[mm]	60	100	120	150
Minimum edge distance	c_{min}	[mm]	95	135	165	200
Minimum thickness of member	h_{min}	[mm]	100	120	130	160

Requirements of the fastening screw or the threaded rod acc. to the engineering documents:

-Minimum property class 5.6 acc. to EN ISO 898-1

-Minimum screwing depth $L_{sd,min}$ acc. to Table 3

-The length of the screw shall be determined depending on thickness of the fixture t_{fix} , available thread length L_{th} and minimum screwing depth $L_{sd,min}$

K-A-L-M Drop In Anchor SAK

Dimensions, materials and installation parameters

Annex 2

of the European
technical approval
ETA-11/0163

**Table 4: Design method A -
Characteristic values of resistance to tension load**

anchor size			M8 ³⁾	M10	M12	M16
steel failure screw 5.6						
characteristic resistance	$N_{Rk,s}$	[kN]	18	28	42	78
partial safety factor	γ_{Ms} ¹⁾	[-]	2,0			
pullout and splitting failure						
characteristic resistance C20/25	$N_{Rk,p}$	[kN]	7,5	9	12	20
partial safety factor	γ_{Mc} ¹⁾²⁾	[-]	2,10			1,8
edge distance	$C_{cr,sp}$	[mm]	95	135	165	200
spacing	$S_{cr,sp}$	[mm]	190	270	330	400
increasing factors for $N_{Rk,p}$	Ψ_c	C30/37	1,08			
		C40/50	1,13			
		C50/60	1,15			

concrete cone failure						
effective anchoring depth	h_{ef}	[mm]	30	40	50	65
edge distance	$C_{cr,N}$	[mm]	1,5 h_{ef}			
spacing	$S_{cr,N}$	[mm]	3 h_{ef}			
partial safety factor	γ_{Mc} ¹⁾²⁾	[-]	2,1			1,8

1) in absence of other national regulations

2) the partial safety factor γ_2 is included

3) only for applications with statically indeterminate structural components

Table 5: Displacements under tension load

anchor size			M8	M10	M12	M16
load in non-cracked concrete	N	[kN]	3,6	4,3	4,1	7,9
displacement	δ_{N0}	[mm]	0,2			
	$\delta_{N\infty}$	[mm]	0,3			

K-A-L-M Drop In Anchor SAK

Design method A
Characteristic resistance to tension load, displacement

Annex 3

of the European
technical approval
ETA-11/0163

**Table 6: Design method A -
Characteristic values of resistance to shear load**

anchor size	M8	M10	M12	M16
-------------	----	-----	-----	-----

steel failure without lever arm screw 5.6						
characteristic resistance	$V_{Rk,s}$	[kN]	7	9	19	37
partial safety factor	$\gamma_{Ms}^{1)}$	[-]	1,67			

steel failure with lever arm screw 5.6						
characteristic bending moment	$M_{Rk,s}^0$	[Nm]	19	37	65	166
partial safety factor	$\gamma_{Ms}^{1)}$	[-]	1,67			

concrete pryout failure						
factor k in equation (5.6) of ETAG 001, Annex C, section 5.2.3.3			1,0	2,0		
partial safety factor	$\gamma_{Mc}^{1)2)}$	[-]	1,50			

concrete edge failure						
effective length of anchor in shear loading	l_f	[mm]	30	40	50	65
outside diameter of anchor	d_{nom}	[mm]	10	12	15	20
partial safety factor	$\gamma_{Mc}^{1)2)}$	[-]	1,50			

1) in absence of other national regulations

2) the partial safety factor γ_2 is included

Table 7: Displacements under shear load

anchor size	M8	M10	M12	M16		
load in non-cracked concrete	V	[kN]	3,0	3,8	8,1	15,8
displacement	δ_{V0}	[mm]	1,3	1,0	1,7	2,7
	$\delta_{V\infty}$	[mm]	1,9	1,5	2,5	4,0

K-A-L-M Drop in Anchor SAK

Design method A
Characteristic resistance to shear load, displacement

Annex 4

of the European
technical approval
ETA-11/0163

Installation instructions

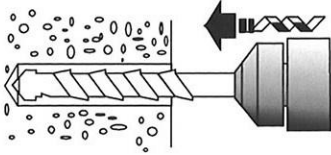

Drill the hole.

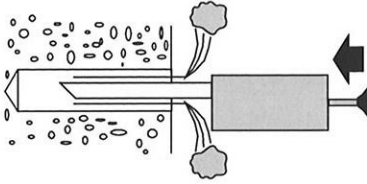

Clean the drill hole.

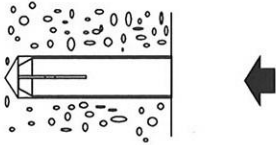

Drive in Anchor SAK.

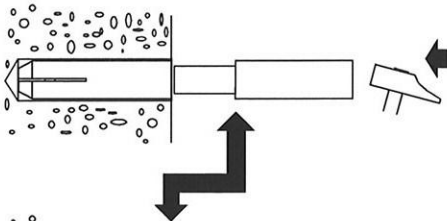

Set the Anchor SAK by using the setting tool.

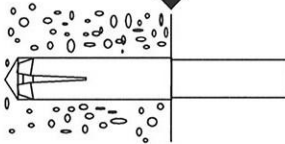

Shoulder of setting tool must fit on anchor rim.

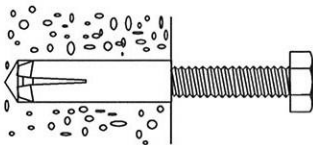

Apply installation torque T_{inst} by using torque wrench.

K-A-L-M Drop in Anchor SAK

Installation instructions

Annex 5

of the European
technical approval
ETA-11/0163