



European Technical Approval ETA-02/0017

English translation prepared by DIBt - Original version in German language

Handelsbezeichnung <i>Trade name</i>	Würth Fixanker W-FAZ-IG/S, W-FAZ-IG/A4, W-FAZ-IG/HCR <i>Würth Fixanchor W-FAZ-IG/S, W-FAZ-IG/A4, W-FAZ-IG/HCR</i>
Zulassungsinhaber <i>Holder of approval</i>	Adolf Würth GmbH & Co. KG Reinhold-Würth-Straße 12-17 74653 Künzelsau DEUTSCHLAND
Zulassungsgegenstand und Verwendungszweck <i>Generic type and use of construction product</i>	Kraftkontrolliert spreizender Dübel mit Innengewinde in den Größen M6, M8, M10 und M12 zur Verankerung im Beton <i>Torque controlled expansion anchor with internal thread of sizes M6, M8, M10 and M12 for use in concrete</i>
Geltungsdauer: <i>Validity:</i>	vom <i>from</i> 17 April 2009 bis <i>to</i> 22 March 2012
verlängert <i>extended</i>	vom <i>from</i> 23 March 2012 bis <i>to</i> 23 March 2017
Herstellwerk <i>Manufacturing plant</i>	Herstellwerk W1, Deutschland

Diese Zulassung umfasst
This Approval contains

18 Seiten einschließlich 10 Anhänge
18 pages including 10 annexes

I LEGAL BASES AND GENERAL CONDITIONS

- 1 This European technical approval is issued by Deutsches Institut für Bautechnik in accordance with:
 - Council Directive 89/106/EEC of 21 December 1988 on the approximation of laws, regulations and administrative provisions of Member States relating to construction products¹, modified by Council Directive 93/68/EEC² and Regulation (EC) N° 1882/2003 of the European Parliament and of the Council³;
 - *Gesetz über das In-Verkehr-Bringen von und den freien Warenverkehr mit Bauprodukten zur Umsetzung der Richtlinie 89/106/EWG des Rates vom 21. Dezember 1988 zur Angleichung der Rechts- und Verwaltungsvorschriften der Mitgliedstaaten über Bauprodukte und anderer Rechtsakte der Europäischen Gemeinschaften (Bauproduktengesetz - BauPG) vom 28. April 1998⁴, as amended by law of 31 October 2006⁵;*
 - Common Procedural Rules for Requesting, Preparing and the Granting of European technical approvals set out in the Annex to Commission Decision 94/23/EC⁶;
 - Guideline for European technical approval of "Metal anchors for use in concrete - Part 2: Torque controlled expansion anchors ", ETAG 001-02.
- 2 Deutsches Institut für Bautechnik is authorized to check whether the provisions of this European technical approval are met. Checking may take place in the manufacturing plant. Nevertheless, the responsibility for the conformity of the products to the European technical approval and for their fitness for the intended use remains with the holder of the European technical approval.
- 3 This European technical approval is not to be transferred to manufacturers or agents of manufacturers other than those indicated on page 1, or manufacturing plants other than those indicated on page 1 of this European technical approval.
- 4 This European technical approval may be withdrawn by Deutsches Institut für Bautechnik, in particular pursuant to information by the Commission according to Article 5(1) of Council Directive 89/106/EEC.
- 5 Reproduction of this European technical approval including transmission by electronic means shall be in full. However, partial reproduction can be made with the written consent of Deutsches Institut für Bautechnik. In this case partial reproduction has to be designated as such. Texts and drawings of advertising brochures shall not contradict or misuse the European technical approval.
- 6 The European technical approval is issued by the approval body in its official language. This version corresponds fully to the version circulated within EOTA. Translations into other languages have to be designated as such.

¹ Official Journal of the European Communities L 40, 11 February 1989, p. 12
² Official Journal of the European Communities L 220, 30 August 1993, p. 1
³ Official Journal of the European Union L 284, 31 October 2003, p. 25
⁴ *Bundesgesetzblatt Teil I 1998*, p. 812
⁵ *Bundesgesetzblatt Teil I 2006*, p. 2407, 2416
⁶ Official Journal of the European Communities L 17, 20 January 1994, p. 34

II SPECIFIC CONDITIONS OF THE EUROPEAN TECHNICAL APPROVAL

1 Definition of product and intended use

1.1 Definition of the construction product

The Würth Fixanchor W-FAZ-IG/S, W-FAZ-IG/A4 and W-FAZ-IG/HCR in the size of M6, M8, M10 and M12 is an anchor made of galvanised or stainless or high corrosion resistant steel with internal thread which is placed into a drilled hole and anchored by torque-controlled expansion. Anchor type V is set in preset installation. Anchor type D with a longer conical bolt is set through the clearance hole of the fixture.

An illustration of the product and intended use is given in Annexes 1 to 3.

1.2 Intended use

The anchor is intended to be used for anchorages for which requirements for mechanical resistance and stability and safety in use in the sense of the Essential Requirements 1 and 4 of Council Directive 89/106 EEC shall be fulfilled and failure of anchorages made with these products would cause risk to human life and/or lead to considerable economic consequences.

The anchor may be used for anchorages with requirements related to resistance to fire.

The anchor is to be used only for anchorages subject to static or quasi-static loading in reinforced or unreinforced normal weight concrete of strength classes C20/25 at minimum and C50/60 at most according to EN 206: 2000. It may be anchored in cracked and non-cracked concrete.

Galvanised steel:

The anchor including screw, nut and washer made of galvanised steel may only be used in structures subject to dry internal conditions.

Stainless steel 1.4401, 1.4404, 1.4362, 1.4571:

The anchor including screw, nut and washer made of stainless steel may be used in structures subject to dry internal conditions and also in structures subject to external atmospheric exposure (including industrial and marine environment), or exposure in permanently damp internal conditions, if no particular aggressive conditions exist. Such particular aggressive conditions are e.g. permanent, alternating immersion in seawater or the splash zone of seawater, chloride atmosphere of indoor swimming pools or atmosphere with extreme chemical pollution (e.g. in desulphurization plants or road tunnels where de-icing materials are used).

High corrosion resistant steel 1.4529, 1.4565:

The anchor may be used in structures subject to dry internal conditions and also in structures subject to external atmospheric exposure, in permanently damp internal conditions or in other particular aggressive conditions. Such particular aggressive conditions are e.g. permanent, alternating immersion in seawater or the splash zone of seawater, chloride atmosphere of indoor swimming pools or atmosphere with chemical pollution (e.g. in desulphurization plants or road tunnels where de-icing materials are used).

The provisions made in this European technical approval are based on an assumed working life of the anchor of 50 years. The indications given on the working life cannot be interpreted as a guarantee given by the producer, but are to be regarded only as a means for choosing the right products in relation to the expected economically reasonable working life of the works.

2 Characteristics of the product and methods of verification

2.1 Characteristics of the product

The anchor corresponds to the drawings and provisions given in Annexes 4 and 5. The characteristic material values, dimensions and tolerances of the anchor not given in Annexes 4 and 5 shall correspond to the respective values laid down in the technical documentation⁷ of this European technical approval.

Regarding the requirements concerning safety in case of fire it is assumed that the anchor meets the requirements of class A1 in relation to reaction to fire in accordance with the stipulations of the Commission decision 96/603/EC, amended by 2000/605/EC.

The characteristic values for the design of anchorages are given in Annexes 6 to 8.

The characteristic values for the design of anchorages regarding resistance to fire are given in Annexes 9 and 10. They are valid for use in a system that is required to provide a specific fire resistance class.

Each anchor is marked with the identifying mark of the producer, the anchor identity and the size of thread according to Annex 4. Each anchor made of stainless steel is marked with the letters "A4". Each anchor made of high corrosion resistant steel is marked with the letters "HCR". In addition, the anchor type D is marked with the maximum thickness of the fixture.

The anchor shall only be packaged and supplied as a complete unit.

2.2 Methods of verification

The assessment of fitness of the anchor for the intended use in relation to the requirements for mechanical resistance and stability and safety in use in the sense of the Essential Requirements 1 and 4 has been made in accordance with the "Guideline for European technical approval of Metal Anchors for use in concrete", Part 1 "Anchors in general" and Part 2 "Torque-controlled expansion anchors", on the basis of Option 1.

The assessment of the anchor for the intended use in relation to the requirements for resistance to fire has been made in accordance with the technical Report TR 020 "Evaluation of anchorages in concrete concerning resistance to fire".

In addition to the specific clauses relating to dangerous substances contained in this European technical approval, there may be other requirements applicable to the products falling within its scope (e.g. transposed European legislation and national laws, regulations and administrative provisions). In order to meet the provisions of the Construction Products Directive, these requirements need also to be complied with, when and where they apply.

⁷ The technical documentation of this European technical approval is deposited at the Deutsches Institut für Bautechnik and, as far as relevant for the tasks of the approved bodies involved in the attestation of conformity procedure, is handed over to the approved bodies.

3 Evaluation and attestation of conformity and CE marking

3.1 System of attestation of conformity

According to the decision 96/582/EG of the European Commission⁸ the system 2(i) (referred to as system 1) of attestation of conformity applies.

This system of attestation of conformity is defined as follows:

System 1: Certification of the conformity of the product by an approved certification body on the basis of:

(a) Tasks for the manufacturer:

- (1) factory production control;
- (2) further testing of samples taken at the factory by the manufacturer in accordance with a prescribed test plan.

(b) Tasks for the approved body:

- (3) initial type-testing of the product;
- (4) initial inspection of factory and of factory production control;
- (5) continuous surveillance, assessment and approval of factory production control.

Note: Approved bodies are also referred to as "notified bodies".

3.2 Responsibilities

3.2.1 Tasks of the manufacturer

3.2.1.1 Factory production control

The manufacturer shall exercise permanent internal control of production. All the elements, requirements and provisions adopted by the manufacturer shall be documented in a systematic manner in the form of written policies and procedures, including records of results performed. This production control system shall insure that the product is in conformity with this European technical approval.

The manufacturer may only use initial/ raw/ constituent materials stated in the technical documentation of this European technical approval.

The factory production control shall be in accordance with the control plan which is part of the technical documentation of this European technical approval. The control plan is laid down in the context of the factory production control system operated by the manufacturer and deposited at Deutsches Institut für Bautechnik⁹.

The results of factory production control shall be recorded and evaluated in accordance with the provisions of the control plan.

3.2.1.2 Other tasks of manufacturer

The manufacturer shall, on the basis of a contract, involve a body which is approved for the tasks referred to in section 3.1 in the field of anchors in order to undertake the actions laid down in section 3.2.2. For this purpose, the control plan referred to in sections 3.2.1.1 and 3.2.2 shall be handed over by the manufacturer to the approved body involved.

The manufacturer shall make a declaration of conformity, stating that the construction product is in conformity with the provisions of this European technical approval.

⁸ Official Journal of the European Communities L 254 of 8.10.1996.

⁹ The control plan is a confidential part of the documentation of the European technical approval, but not published together with the European technical approval and only handed over to the approved body involved in the procedure of attestation of conformity.
See section 3.2.2.

3.2.2 Tasks of approved bodies

The approved body shall perform the

- initial type-testing of the product,
 - initial inspection of factory and of factory production control,
 - continuous surveillance, assessment and approval of factory production control,
- in accordance with the provisions laid down in the control plan.

The approved body shall retain the essential points of its actions referred to above and state the results obtained and conclusions drawn in a written report.

The approved certification body involved by the manufacturer shall issue an EC certificate of conformity of the product stating the conformity with the provisions of this European technical approval.

In cases where the provisions of the European technical approval and its control plan are no longer fulfilled the certification body shall withdraw the certificate of conformity and inform Deutsches Institut für Bautechnik without delay.

3.3 CE marking

The CE marking shall be affixed on each packaging of the anchor. The letters "CE" shall be followed by the identification number of the approved certification body, where relevant, and be accompanied by the following additional information:

- the name and address of the holder of the approval (legal entity responsible for the manufacturer),
- the last two digits of the year in which the CE marking was affixed,
- the number of the EC certificate of conformity for the product,
- the number of the European technical approval,
- the number of the guideline for European technical approval,
- use category (ETAG 001-1 Option 1),
- size.

4 Assumptions under which the fitness of the product for the intended use was favourably assessed

4.1 Manufacturing

The European technical approval is issued for the product on the basis of agreed data/information, deposited with Deutsches Institut für Bautechnik, which identifies the product that has been assessed and judged. Changes to the product or production process, which could result in this deposited data/information being incorrect, should be notified to Deutsches Institut für Bautechnik before the changes are introduced. Deutsches Institut für Bautechnik will decide whether or not such changes affect the European technical approval and consequently the validity of the CE marking on the basis of the European technical approval and if so whether further assessment or alterations to the European technical approval shall be necessary.

4.2 Design of anchorages

The fitness of the anchor for the intended use is given under the following conditions:

The anchorages are designed in accordance with the "Guideline for European technical approval of Metal Anchors for Use in Concrete", Annex C, Method A under the responsibility of an engineer experienced in anchorages and concrete work.

Verifiable calculation notes and drawings are taking account of the loads to be anchored.

The position of the anchor is indicated on the design drawings (e.g. position of the anchor relative to reinforcement or to supports).

The design of anchorages under fire exposure has to consider the conditions given in the technical Report TR 020 "Evaluation of anchorages in concrete concerning resistance to fire". The relevant characteristic anchor values are given in Annexes 9 and 10. The design method covers anchors with a fire attack from one side only. If the fire attack is from more than one side, the design method may be taken only, if the edge distance of the anchor is $c \geq 300$ mm.

4.3 Installation of anchors

The fitness for use of the anchor can only be assumed if the anchor is installed as follows:

- Anchor installation carried out by appropriately qualified personnel and under the supervision of the person responsible for technical matters of the site,
- Use of the anchor only as supplied by the manufacturer without exchanging the components of an anchor,
- For anchor version MU-IG the commercial standard rod may only be used if the following requirements are fulfilled:
 - Material, Dimensions and mechanical properties according to Annex 5, Table 3,
 - Confirmation of material and mechanical properties of the metal parts by inspection certificate 3.1 according to EN 10204:2004, the documents should be stored,
 - Use of the hexagon nut and washer with special coating as supplied by the holder of the approval.
- Anchor installation in accordance with the manufacturer's specifications and drawings and using the appropriate tools,
- Checks before placing the anchor to ensure that the strength class of the concrete in which the anchor is to be placed is in the range given and is not lower than that of the concrete to which the characteristic loads apply,
- Check of concrete being well compacted, e.g. without significant voids,
- Edge distances and spacings not less than the specified values without minus tolerances,
- Positioning of the drill holes without damaging the reinforcement,
- In case of aborted hole: new drilling at a minimum distance away of twice the depth of the aborted hole or smaller distance if the aborted drill hole is filled with high strength mortar and if under shear or oblique tension load it is not in the direction of load application,
- Cleaning of the hole of drilling dust,
- Anchor installation such that the effective anchorage depth is complied with. The anchor type V for pre-set installation is placed correctly in the drill hole if the setting tool leaves a visible circular imprint on the concrete surface. The anchor type D for In-place installation is properly set if the stop of the setting tool reaches the fixture.
- Keeping of the minimum screwing depth L_{sd} according to Annex 6.
- Application of the torque moment given in Annex 6 using a calibrated torque wrench.

5 Indications to the manufacturer

The manufacturer is responsible to ensure that the information on the specific conditions according to 1 and 2 including Annexes referred to as well as sections 4.2 and 4.3 is given to those who are concerned. This information may be made by reproduction of the respective parts of the European technical approval. In addition all installation data shall be shown clearly on the package and/or on an enclosed instruction sheet, preferably using illustration(s).

The minimum data required are:

- Diameter of drill bit,
- Thread diameter,
- Maximum thickness of the fixture,
- Minimum effective anchorage depth,
- Minimum hole depth,
- Torque moment,
- Information on the installation procedure, including cleaning of the hole, preferably by means of an illustration,
- Reference to any special installation equipment needed,
- Identification of the manufacturing batch.

All data shall be presented in a clear and explicit form.

Georg Feistel
Head of Department

beglaubigt:
Baderschneider

Anchor system W-FAZ-IG Type S consisting of W-FAZ-IG and S-IG

W-FAZ-IG

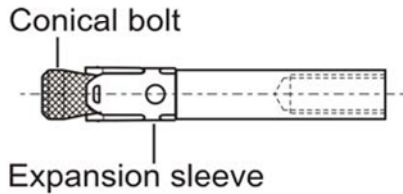

S-IG

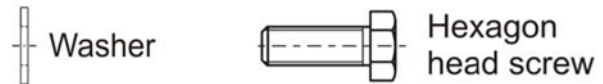

Installation type V pre-setting installation

pre-set anchor body, the fixture bears on the screw only

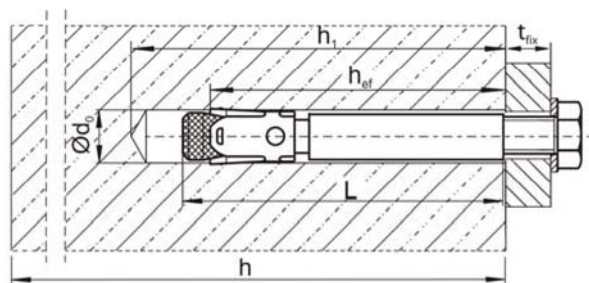
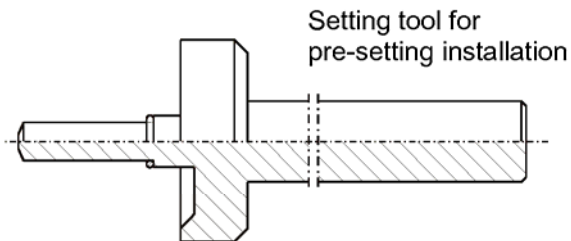

Installation type D through-setting installation

the anchor is set through the fixture, the fixture bears on the conical bolt W-FAZ-IG

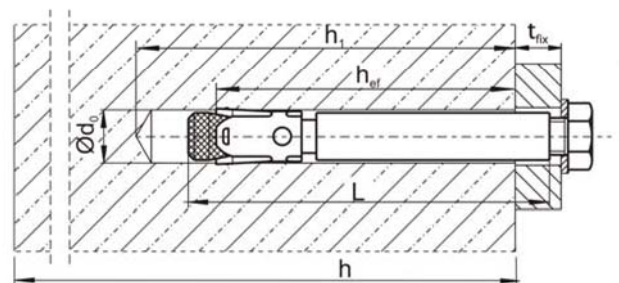
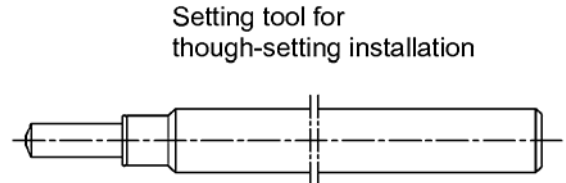

Würth Fixanchor W-FAZ-IG/S, W-FAZ-IG/A4, W-FAZ-IG/HCR

Anchor system W-FAZ-IG Type S,
Product and intended use,
Installation type V and Installation type D

Annex 1

Anchor system W-FAZ-IG Type SK consisting of W-FAZ-IG and SK-IG

W-FAZ-IG

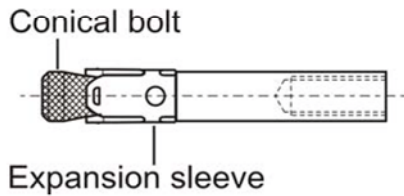

SK-IG

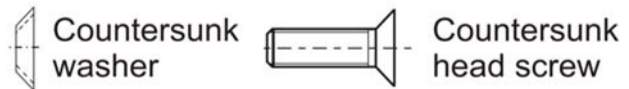

Installation type V pre-setting installation

pre-setting anchor body, the fixture bears on the screw only

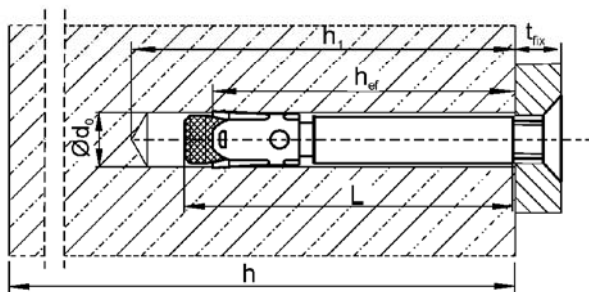
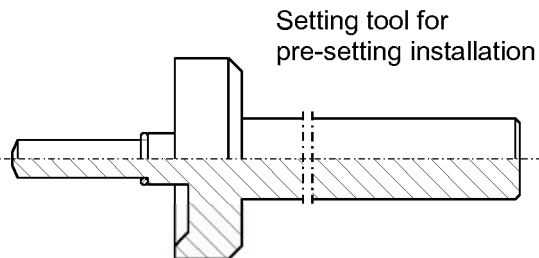

Installation type D through-setting installation

the anchor is set through the fixture, the fixture bears on the conical bolt W-FAZ-IG

Setting tool for through-setting installation

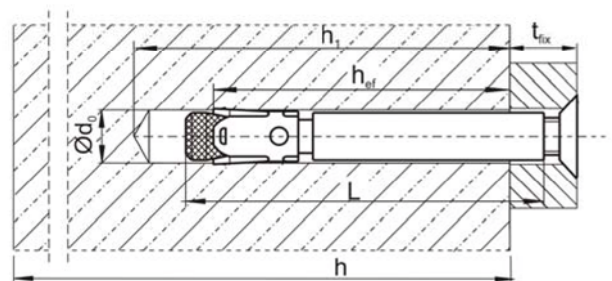
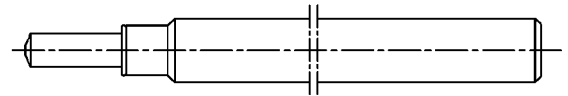

Würth Fixanchor W-FAZ-IG/S, W-FAZ-IG/A4, W-FAZ-IG/HCR

Anchor system W-FAZ-IG Type SK,
Product and intended use,
Installation type V and Installation type D

Annex 2

Anchor system W-FAZ-IG Type B consisting of W-FAZ-IG and MU-IG

W-FAZ-IG

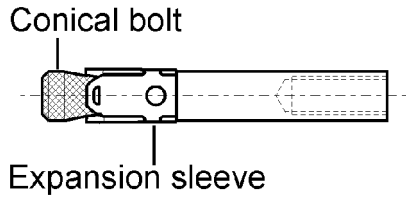

MU-IG

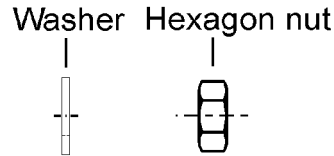

Commercial standard rod



Installation type V pre-setting installation

pre-set anchor body, the fixture bears on the threaded rod only

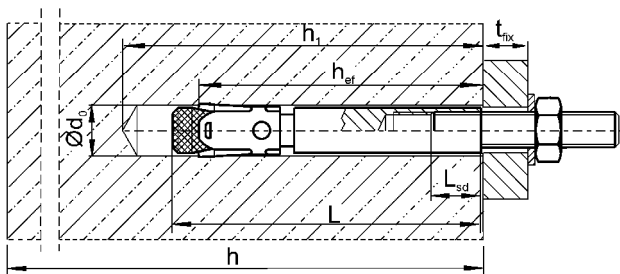
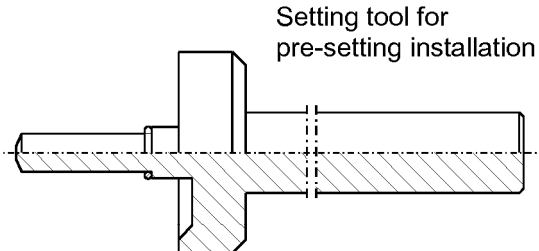

Installation type D through-setting installation

the anchor is set through the fixture, the fixture bears on the conical bolt W-FAZ-IG

Setting tool for through-setting installation

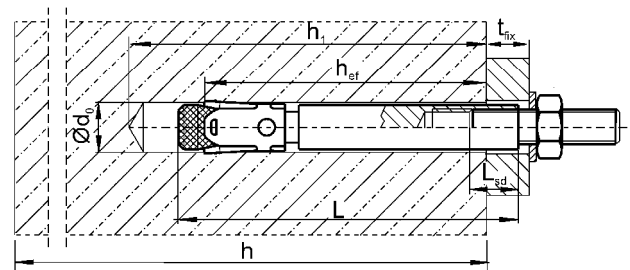
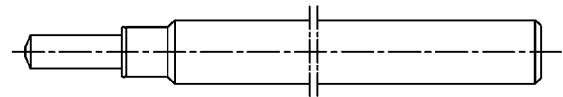

Würth Fixanchor W-FAZ-IG/S, W-FAZ-IG/A4, W-FAZ-IG/HCR

Anchor system W-FAZ-IG Type B,
Product and intended use,
Installation type V and Installation type D

Annex 3

- Marking:**
- Identifying mark of Manufacturing plant
 - Anchor identify
 - Size of thread
 - max. thickness of fixture (only installation type D)
 - additionally for stainless steel
 - additionally for high corrosion Resistant steel



BZ

M6

10

A4

HCR

e.g. \diamond BZ M6-10 A4

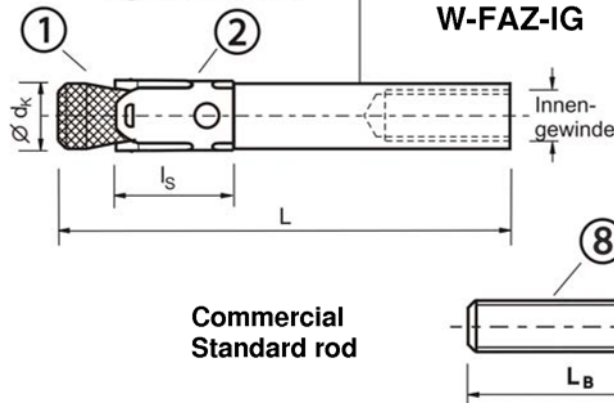

W-FAZ-IG

Commercial Standard rod

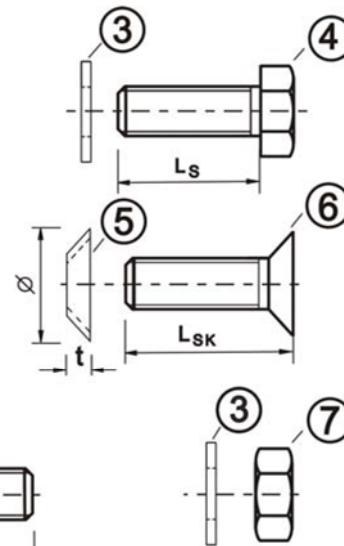
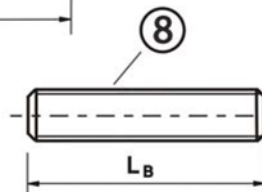

S-IG

SK-IG

MU-IG

Table 1: Anchor dimensions

No.	Anchor size		M6	M8	M10	M12
1	Conical bolt with Internal thread Installation type V Installation type D	$\varnothing d_k$	7.9	9.8	11.8	15.7
		L	50	62	70	86
		L	$50 + t_{fix}$	$62 + t_{fix}$	$70 + t_{fix}$	$86 + t_{fix}$
2	Expansion sleeve	l_s	14.5	18.5	22.0	24.3
3	Washer		see table 2			
4	Hexagon head screw Installation type V Installation type D	width across flats	10	13	17	19
		L_s	$t_{fix} + (13 \text{ bis } 21)$	$t_{fix} + (17 \text{ bis } 23)$	$t_{fix} + (21 \text{ bis } 25)$	$t_{fix} + (24 \text{ bis } 29)$
		L_s	14 bis 20	18 bis 22	20 bis 22	25 bis 28
5	Countersunk washer	\varnothing countersink	17.3	21.5	25.9	30.9
		t	3.9	5.0	5.7	6.7
6	Countersunk head screw Installation type V Installation type D	bit size	Torx T30	Torx T45 (Steel vz.) T40 (Stainless steel A4, HCR)	hexagon socket 6 mm	hexagon socket 8 mm
		L_{SK}	$t_{fix} + (11 \text{ to } 19)$	$t_{fix} + (15 \text{ to } 21)$	$t_{fix} + (19 \text{ to } 23)$	$t_{fix} + (21 \text{ to } 27)$
		L_{SK}	16 to 20	20 to 25	25	30
7	Hexagon nut	width across flats	10	13	17	19
8	Commercial standard rod ¹⁾	type V $L_B \geq$	$t_{fix} + 21$	$t_{fix} + 28$	$t_{fix} + 34$	$t_{fix} + 41$
		type D $L_B \geq$	21	28	34	41

¹⁾ acc. to specifications (Table 2)

Dimensions in mm

Würth Fixanchor W-FAZ-IG/S, W-FAZ-IG/A4, W-FAZ-IG/HCR

Anchor dimensions

Annex 4

Table 2: Materials

No.	Part	Steel, zinc plated ≥ 5 µm acc. to EN ISO 4042	Stainless steel A4	High corrosion resistant steel HCR
1	Conical bolt W-FAZ-IG With internal thread	Machined steel, Cone plastic coated	Stainless steel, 1.4401, 1.4404, 1.4571, 1.4362, EN 10088, Cone plastic coated	Stainless steel, 1.4529, 1.4565, EN 10088, Cone plastic coated
2	Expansion sleeve W-FAZ-IG	Stainless steel, 1.4301, 1.4303, EN 10088	Stainless steel, 1.4401, 1.4571, EN 10088	Stainless steel, 1.4401, 1.4571, EN 10088
3	Washer S-IG / MU-IG acc. to DIN EN 7089 or DIN EN 7093 or DIN EN 7094	Steel, EN 10025-2	Stainless steel, 1.4401, 1.4571, EN 10088	Stainless steel, 1.4529, 1.4565, EN 10088
4	Hexagon head screw S-IG	Steel, Property class 8.8, EN ISO 898-1, coated	Stainless steel, 1.4401, 1.4571, EN 10088, Property class 70, EN ISO 3506, coated	Stainless steel, 1.4529, 1.4565, EN 10088, Property class 70, EN ISO 3506, coated
5	Countersunk washer SK-IG	Steel, EN 10083-2	Stainless steel, 1.4401, 1.4404, 1.4571, EN 10088, zinc plated, coated	Stainless steel, 1.4529, 1.4565, EN 10088, zinc plated, coated
6	Countersunk head screw SK-IG	Steel, Property class 8.8, acc. to EN ISO 898-1, coated	Stainless steel, 1.4401, 1.4571, EN 10088, Property class 70, EN ISO 3506, coated	Stainless steel, 1.4529, 1.4565, EN 10088, Property class 70, EN ISO 3506, coated
7	Hexagon nut MU-IG	Steel, Property class 8, acc. to EN 20898-2, coated	Stainless steel, 1.4401, 1.4571, EN 10088, Property class 70, EN ISO 3506, coated	Stainless steel, 1.4529, 1.4565, EN 10088, Property class 70, EN ISO 3506, coated
8	Commercial standard rod	Property class 8.8, acc. to EN ISO 898-1 A ₅ > 8 % ductile	Stainless steel, 1.4401, 1.4571, EN 10088, Property class 70, EN ISO 3506	Stainless steel, 1.4529, 1.4565, EN 10088, Property class 70, EN ISO 3506

Würth Fixanchor W-FAZ-IG/S, W-FAZ-IG/A4, W-FAZ-IG/HCR

Materials

Annex 5

Table 3: Installation parameters

Anchor size			M6	M8	M10	M12
Effective anchorage depth	h_{ef}	[mm]	45	58	65	80
Drill hole diameter	d_0	[mm]	8	10	12	16
Cutting diameter of drill bit	$d_{cut} \leq$	[mm]	8.45	10.45	12.5	16.5
Depth of drill hole	$h_1 \geq$	[mm]	60	75	90	105
Screwing depth of thread rod	$L_{sd}^{2)} \geq$	[mm]	9	12	15	18
Installation moment, zinc plated steel	S	[Nm]	10	30	30	55
	SK	[Nm]	10	25	40	50
	B	[Nm]	8	25	30	45
Installation moment, stainless steel A4 and high corrosion resistant steel HCR	S	[Nm]	15	40	50	100
	SK	[Nm]	12	25	45	60
	B	[Nm]	8	25	40	80
Installation type V						
Diameter of clearance hole in the fixture	$d_f \leq$	[mm]	7	9	12	14
Minimum thickness of fixture	S	[mm]	1	1	1	1
	SK	[mm]	5	7	8	9
	B	[mm]	1	1	1	1
Installation type D						
Diameter of clearance hole in the fixture	$d_f \leq$	[mm]	9	12	14	18
Minimum thickness of fixture ¹⁾	S	[mm]	5	7	8	9
	SK	[mm]	9	12	14	16
	B	[mm]	5	7	8	9

¹⁾ The minimum thickness of fixture can be reduced to the value of installation type V, if the shear load at steel failure is designed with lever arm according to equation (5.5) of ETAG 001, Annex C.

²⁾ indication see Annex 3

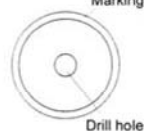

Setting check for Installation type V:

The anchor is placed correctly in the drill hole if the setting tool leaves a visible marking on the concrete surface.

Table 4: Minimum thickness of concrete member, minimum spacing and minimum edge distance

Anchor size			M6	M8	M10	M12
Minimum thickness of concrete member	h_{min}	[mm]	100	120	130	160
Cracked concrete						
Minimum spacing	s_{min}	[mm]	50	60	70	80
	für $c \geq$	[mm]	60	80	100	120
Minimum edge distance	c_{min}	[mm]	50	60	70	80
	für $s \geq$	[mm]	75	100	100	120
Non-cracked concrete						
Minimum spacing	s_{min}	[mm]	50	60	65	80
	für $c \geq$	[mm]	80	100	120	160
Minimum edge distance	c_{min}	[mm]	50	60	70	100
	für $s \geq$	[mm]	115	155	170	210

Würth Fixanchor W-FAZ-IG/S, W-FAZ-IG/A4, W-FAZ-IG/HCR

**Installation parameters,
Minimum member thickness,
Minimum spacing and edge distance**

Annex 6

Table 5: Characteristic values of resistance to tension loads of design method A

Anchor size			M6	M8	M10	M12
Steel failure						
Characteristic resistance, steel zinc plated	$N_{Rk,s}$	[kN]	16.1	22.6	26.0	56.6
Partial safety factor	$\gamma_{Ms}^{1)}$	[-]	1.5			
Characteristic resistance, stainless steel A4 and high corrosion resistant steel HCR	$N_{Rk,s}$	[kN]	14.1	25.6	35.8	59.0
Partial safety factor	$\gamma_{Ms}^{1)}$	[-]	1.87			
Pullout failure						
Characteristic resistance in cracked concrete	$N_{Rk,p}$ C20/25	[kN]	5	9	12	20
Pullout and splitting (Choice of minimum spacing and edge distance)						
Characteristic resistance in non-cracked concrete	$N_{Rk,p}$ C20/25	[kN]	9	12	16	25
Respective spacing	$s_{cr,sp}$	[mm]	3 h_{ef}			
Respective edge distance	$c_{cr,sp}$	[mm]	1.5 h_{ef}			
Pullout and splitting (Choice of maximum resistance)						
Characteristic resistance in non-cracked concrete	$N_{Rk,p}$ C20/25	[kN]	12	16	20	30
Respective spacing	$s_{cr,sp}$	[mm]	5 h_{ef}			
Respective edge distance	$c_{cr,sp}$	[mm]	2.5 h_{ef}			
Increasing factors for $N_{Rk,p}$ for cracked and non-cracked concrete	ψ_C C30/37	[-]	1.22			
	C40/50	[-]	1.41			
	C50/60	[-]	1.55			
Partial safety factor	$\gamma_{Mp} = \gamma_{Msp}^{1)}$	[-]	1.8 ²⁾			
Concrete cone failure						
Effective anchoring depth	h_{ef}	[mm]	45	58	65	80
Spacing	$s_{cr,N}$	[mm]	3 h_{ef}			
Edge distance	$c_{cr,N}$	[mm]	1.5 h_{ef}			
Partial safety factor	$\gamma_{Mc}^{1)}$	[-]	1.8 ²⁾			

¹⁾ In absence of other national regulations

²⁾ The partial safety factor $\gamma_2 = 1,2$ included

Table 6: Displacements under tension loads

Anchor size			M6	M8	M10	M12
Tension load in cracked concrete	N	[kN]	2.0	3.6	4.8	8.0
Displacement	δ_{N0}	[mm]	0.6	0.6	0.8	1.0
	$\delta_{N\infty}$	[mm]	0.8	0.8	1.2	1.4
Tension load in non-cracked concrete	N	[kN]	4.8	6.4	8.0	12.0
Displacement	δ_{N0}	[mm]	0.4	0.5	0.7	0.8
	$\delta_{N\infty}$	[mm]	0.8	0.8	1.2	1.4

Würth Fixanchor W-FAZ-IG/S, W-FAZ-IG/A4, W-FAZ-IG/HCR

Design method A,
Characteristic values of resistance to tension loads,
Displacements

Annex 7

Table 7: Characteristic values of resistance to shear loads of design method A

Anchor size			M6	M8	M10	M12
W-FAZ-IG zinc plated						
Steel failure without lever arm, Installation type V						
Characteristic resistance	$V_{Rk,s}$	[kN]	5.8	6.9	10.4	25.8
Steel failure without lever arm, Installation type D						
Characteristic resistance	$V_{Rk,s}$	[kN]	5.1	7.6	10.8	24.3
Steel failure with lever arm, Installation type V						
Characteristic bending resistance	$M^0_{Rk,s}$	[Nm]	12.2	30.0	59.8	104.6
Steel failure with lever arm, Installation type D						
Characteristic bending resistance	$M^0_{Rk,s}$	[Nm]	36.0	53.2	76.0	207
Partial safety factor for $V_{Rk,s}$ (type V, D) and $M^0_{Rk,s}$ (type V, D)	$\gamma_{Ms}^{1)}$	[-]	1.25			
W-FAZ-IG stainless steel A4 and high corrosion resistant steel HCR						
Steel failure without lever arm, Installation type V						
Characteristic resistance	$V_{Rk,s}$	[kN]	5.7	9.2	10.6	23.6
Partial safety factor	$\gamma_{Ms}^{1)}$	[-]	1.25			
Steel failure without lever arm, Installation type D						
Characteristic resistance	$V_{Rk,s}$	[kN]	7.3	7.6	9.7	29.6
Partial safety factor	$\gamma_{Ms}^{1)}$	[-]	1.25			
Steel failure with lever arm, Installation type V						
Characteristic bending resistance	$M^0_{Rk,s}$	[Nm]	10.7	26.2	52.3	91.6
Partial safety factor	$\gamma_{Ms}^{1)}$	[-]	1.56			
Steel failure with lever arm, Installation type D						
Characteristic bending resistance	$M^0_{Rk,s}$	[Nm]	28.2	44.3	69.9	191.2
Partial safety factor	$\gamma_{Ms}^{1)}$	[-]	1.25			
Concrete pryout failure						
Factor in equation (5.6) ETAG Annex C, 5.2.3.3	k	[-]	1.5	1.5	2.0	2.0
Partial safety factor	$\gamma_{Mcp}^{1)}$	[-]	1.5 ²⁾			
Concrete edge failure						
Effective length of anchor in shear loading	l_f	[mm]	45	58	65	80
Effective diameter of anchor	d_{nom}	[mm]	8	10	12	16
Partial safety factor	$\gamma_{Mc}^{1)}$	[-]	1.5 ²⁾			

¹⁾ In absence of other national regulations

²⁾ The partial safety factor $\gamma_2 = 1.0$ is included.

Table 8: Displacements under shear loads

Anchor size			M6	M8	M10	M12
Shear load in cracked and non-cracked concrete	V	[kN]	4.2	5.3	6.2	16.9
Displacements	δ_{V0}	[mm]	2.8	2.9	2.5	3.6
	$\delta_{V\infty}$	[mm]	4.2	4.4	3.8	5.3

Würth Fixanchor W-FAZ-IG/S, W-FAZ-IG/A4, W-FAZ-IG/HCR

**Design method A,
Characteristic values of resistance to shear loads,
Displacements**

Annex 8

Table 9: Characteristic values to tension loads under fire exposure in cracked and non-cracked concrete C20/25 to C50/60

Anchor size	M 6			M 8			M 10			M 12														
	30	60	90	120	30	60	90	120	30	60	90	120												
Fire resistance duration R... [min]	30	60	90	120	30	60	90	120	30	60	90	120												
Steel failure:																								
Characteristic resistance $N_{Rk,s,fi}$ [kN]	Steel zinc plated	0.7	0.6	0.5	0.4	1.4	1.2	0.9	0.8	2.5	2.0	1.5	1.3	3.7	2.9	2.2	1.8							
	Stainless steel A4 / HCR	2.9	1.9	1.0	0.5	5.4	3.8	2.1	1.3	8.7	6.3	3.9	2.7	12.6	9.2	5.7	4.0							
Pullout failure:																								
Characteristic resistance in concrete C20/25 to C50/60 $N_{Rk,p,fi}$ [kN]	1.3			1.0			2.3			1.8			3.0			2.4			5.0			4.0		
Concrete cone failure:																								
Characteristic resistance in concrete C20/25 to C50/60 $N^0_{Rk,c,fi}$ [kN]	2.4			2.0			4.6			3.7			6.1			4.9			10.3			8.2		
Spacing $S_{cr,N,fi}$	4 x h_{ef}																							
Edge Distance $C_{cr,N,fi}$	2 x h_{ef}																							
Minimum spacing and edge distance under fire exposure from one side	according to Annex 6																							
Minimum spacing and edge distance under fire exposure from more than one size	s_{min} according to Annex 6; $C_{min} \geq 300$ mm.																							

In absence of other national regulations the partial safety factor for resistance under fire exposure $\gamma_{M,fi} = 1,0$ is recommended.

Würth Fixanchor W-FAZ-IG/S, W-FAZ-IG/A4, W-FAZ-IG/HCR

Characteristic values of tension load resistance under fire exposure

Annex 9

Table 10: Characteristic values to shear loads under fire exposure in cracked and non-cracked concrete C20/25 to C50/60

Anchor size:	M 6			M 8			M 10			M 12									
	30	60	90	120	30	60	90	120	30	60	90	120							
Fire resistance duration R... [min]	30	60	90	120	30	60	90	120	30	60	90	120							
Steel failure without lever arm:																			
Characteristic resistance $V_{Rk,s,fi}$ [kN]	Steel zinc plated			0,7	0,6	0,5	0,4	1,4	1,2	0,9	0,8	2,5	2,0	1,5	1,3	3,7	2,9	2,2	1,8
	Stainless steel A4 / HCR			2,9	1,9	1,0	0,5	5,4	3,8	2,1	1,3	8,7	6,3	3,9	2,7	12,6	9,2	5,7	4,0
Steel failure with lever arm:																			
Characteristic Resistance $M^0_{Rk,s,fi}$ [Nm]	Steel			0,5	0,4	0,4	0,3	1,4	1,2	0,9	0,8	3,3	2,6	2,0	1,6	5,7	4,6	3,4	2,8
	A4 / HCR			2,2	1,5	0,7	0,4	5,5	3,9	2,2	1,3	11,2	8,1	5,1	3,5	19,6	14,3	8,9	6,2
Concrete pryout failure:																			
In Equation (5.6) of ETAG 001, Annex C, 5.2.3.3 the k-factor of Table 7 and the relevant values of $N^0_{Rk,c,fi}$ of Table 9 have to be considered.																			
Concrete edge failure:																			
The initial value $V^0_{Rk,c,fi}$ of the characteristic resistance in concrete C20/25 to C50/60 under fire exposure may be determined by: $V^0_{Rk,c,fi} = 0,25 \times V^0_{Rk,c}$ (R30, R 60, R90) $V^0_{Rk,c,fi} = 0,20 \times V^0_{Rk,c}$ (R120) with $V^0_{Rk,c}$ initial value if the characteristic resistance in cracked concrete C20/25 under normal temperature.																			
In absence of other national regulations the partial safety factor for resistance under fire exposure $\gamma_{M,fi} = 1,0$ is recommended.																			

Würth Fixanchor W-FAZ-IG/S, W-FAZ-IG/A4, W-FAZ-IG/HCR

Characteristic values of shear load resistance under fire exposure

Annex 10