



European Technical Approval ETA-02/0032

English translation prepared by DIBt - Original version in German language

Handelsbezeichnung <i>Trade name</i>	Hilti Kompaktdübel HKD <i>Hilti push-in anchor HKD</i>	
Zulassungsinhaber <i>Holder of approval</i>	Hilti Aktiengesellschaft Business Unit Anchors 9494 Schaan FÜRSTENTUM LIECHTENSTEIN	
Zulassungsgegenstand und Verwendungszweck <i>Generic type and use of construction product</i>	Wegkontrolliert spreizender Dübel aus galvanisch verzinktem oder nichtrostendem Stahl in den Größen M6, M8, M10, M12, M16 und M20 zur Verankerung im ungerissenen Beton <i>Deformation-controlled expansion anchor made of galvanised or stainless steel of sizes M6, M8, M10, M12, M16 and M20 for use in non-cracked concrete</i>	
Geltungsdauer: <i>Validity:</i>	vom <i>from</i>	22 April 2010
	bis <i>to</i>	17 October 2012
verlängert <i>extended</i>	vom <i>from</i>	18 October 2012
	bis <i>to</i>	18 October 2017
Herstellwerk <i>Manufacturing plant</i>	Hilti Aktiengesellschaft	

Diese Zulassung umfasst
This Approval contains

21 Seiten einschließlich 13 Anhänge
21 pages including 13 annexes

I LEGAL BASES AND GENERAL CONDITIONS

- 1 This European technical approval is issued by Deutsches Institut für Bautechnik in accordance with:
 - Council Directive 89/106/EEC of 21 December 1988 on the approximation of laws, regulations and administrative provisions of Member States relating to construction products¹, modified by Council Directive 93/68/EEC² and Regulation (EC) N° 1882/2003 of the European Parliament and of the Council³;
 - Gesetz über das In-Verkehr-Bringen von und den freien Warenverkehr mit Bauprodukten zur Umsetzung der Richtlinie 89/106/EWG des Rates vom 21. Dezember 1988 zur Angleichung der Rechts- und Verwaltungsvorschriften der Mitgliedstaaten über Bauprodukte und anderer Rechtsakte der Europäischen Gemeinschaften (Bauproduktengesetz - BauPG) vom 28. April 1998⁴, as amended by Article 2 of the law of 8 November 201⁵;
 - Common Procedural Rules for Requesting, Preparing and the Granting of European technical approvals set out in the Annex to Commission Decision 94/23/EC⁶;
 - Guideline for European technical approval of "Metal anchors for use in concrete - Part 4: Deformation controlled expansion anchors", ETAG 001-04.
- 2 Deutsches Institut für Bautechnik is authorized to check whether the provisions of this European technical approval are met. Checking may take place in the manufacturing plant. Nevertheless, the responsibility for the conformity of the products to the European technical approval and for their fitness for the intended use remains with the holder of the European technical approval.
- 3 This European technical approval is not to be transferred to manufacturers or agents of manufacturers other than those indicated on page 1, or manufacturing plants other than those indicated on page 1 of this European technical approval.
- 4 This European technical approval may be withdrawn by Deutsches Institut für Bautechnik, in particular pursuant to information by the Commission according to Article 5(1) of Council Directive 89/106/EEC.
- 5 Reproduction of this European technical approval including transmission by electronic means shall be in full. However, partial reproduction can be made with the written consent of Deutsches Institut für Bautechnik. In this case partial reproduction has to be designated as such. Texts and drawings of advertising brochures shall not contradict or misuse the European technical approval.
- 6 The European technical approval is issued by the approval body in its official language. This version corresponds fully to the version circulated within EOTA. Translations into other languages have to be designated as such.

¹ Official Journal of the European Communities L 40, 11 February 1989, p. 12

² Official Journal of the European Communities L 220, 30 August 1993, p. 1

³ Official Journal of the European Union L 284, 31 October 2003, p. 25

⁴ *Bundesgesetzblatt Teil I* 1998, p. 812

⁵ *Bundesgesetzblatt Teil I* 2011, p. 2178

⁶ Official Journal of the European Communities L 17, 20 January 1994, p. 34

II SPECIFIC CONDITIONS OF THE EUROPEAN TECHNICAL APPROVAL

1 Definition of the construction product and intended use

1.1 Definition of the product

The Hilti-push-in anchor HKD of sizes M6, M8, M10, M12, M16 and M20 is an anchor made of galvanised or stainless steel which is placed into a drilled hole and anchored by deformation-controlled expansion.

The anchor consists of an anchor body and an internal plug.

An illustration of the product and intended use is given in Annex 1.

The fixture shall be anchored with a fastening screw or threaded rod according to Annex 5.

1.2 Intended use

The anchor is intended to be used for anchorages for which requirements for mechanical resistance and stability and safety in use in the sense of the Essential Requirements 1 and 4 of Council Directive 89/106 EEC shall be fulfilled and failure of anchorages made with these products would cause risk to human life and/or lead to considerable economic consequences. The anchor is to be used only for anchorages subject to static or quasi-static loading in reinforced or unreinforced normal weight concrete of strength classes C20/25 at minimum and C50/60 at most according to EN 206-1:2000-12.

It may be anchored in non-cracked concrete only.

Anchor made of galvanised steel (Hilti HKD, HKD-woL, HKD-S, HKD-E):

The anchor made of galvanised steel may only be used in structures subject to dry internal conditions.

Anchor made of stainless steel (Hilti HKD-SR, HKD-ER):

The anchor made of stainless steel may be used in structures subject to dry internal conditions and also in structures subject to external atmospheric exposure (including industrial and marine environment), or exposure in permanently damp internal conditions, if no particular aggressive conditions exist. Such particular aggressive conditions are e.g. permanent, alternating immersion in seawater or the splash zone of seawater, chloride atmosphere of indoor swimming pools or atmosphere with extreme chemical pollution (e. g. in desulphurization plants or road tunnels where de-icing materials are used).

The provisions made in this European technical approval are based on an assumed intended working life of the anchor of 50 years. The indications given on the working life cannot be interpreted as a guarantee given by the producer, but are to be regarded only as a means for choosing the right products in relation to the expected economically reasonable working life of the works.

2 Characteristics of the product and methods of verification

2.1 Characteristics of the product

The anchor corresponds to the drawings and provisions given in Annexes 1 to 3. The characteristic material values, dimensions and tolerances of the anchor not indicated in Annexes 1 to 3 shall correspond to the respective values laid down in the technical documentation⁷ of this European technical approval.

The characteristic values for the design of anchorages are given in Annexes 7 to 13.

The following designations are used for different anchor versions (see Annex 1):

- HKD cold formed anchor made of galvanised steel with lip
- HKD-woL cold formed anchor made of galvanised steel without lip
- HKD-S machined anchor made of galvanised steel with lip
- HKD-SR machined anchor made of stainless steel with lip
- HKD-E machined anchor made of galvanised steel without lip
- HKD-ER machined anchor made of stainless steel without lip

Each anchor is marked with the identifying mark of the producer, the anchor identity, the thread size, the effective anchorage depth (h_{ef}) and the outer diameter of the anchor body ($\varnothing d_1$) according to Annex 1. In addition, the anchor body for anchor size M8x40 and M10x40 are marked on the top of the anchor body according to Annex 2. The anchor made of stainless steel is marked with the additional letter "R".

The anchor shall only be packaged and supplied as a complete unit.

2.2 Methods of verification

The assessment of fitness of the anchor for the intended use in relation to the requirements for mechanical resistance and stability and safety in use in the sense of the Essential Requirements 1 and 4 has been made in accordance with the "Guideline for European technical approval of Metal Anchors for Use in Concrete", Part 1 "Anchors in general" and Part 4 "Deformation-controlled expansion anchors" on the basis of Option 7.

In addition to the specific clauses relating to dangerous substances contained in this European technical approval, there may be other requirements applicable to the products falling within its scope (e.g. transposed European legislation and national laws, regulations and administrative provisions). In order to meet the provisions of the Construction Products Directive, these requirements need also to be complied with, when and where they apply.

⁷ The technical documentation of this European technical approval is deposited at the Deutsches Institut für Bautechnik and, as far as relevant for the tasks of the approved bodies involved in the attestation of conformity procedure, is handed over to the approved bodies.

3 Evaluation and attestation of conformity and CE marking

3.1 System of attestation of conformity

According to the Decision 89/106/EEC of the European Commission⁸ system 2(i) (referred to as System 1) of the attestation of conformity applies.

This system of attestation of conformity is defined as follows:

System 1: Certification of the conformity of the product by an approved certification body on the basis of:

- (a) Tasks for the manufacturer:
 - (1) factory production control;
 - (2) further testing of samples taken at the factory by the manufacturer in accordance with the control plan;
- (b) Tasks for the approved body:
 - (3) initial type-testing of the product;
 - (4) initial inspection of factory and of factory production control;
 - (5) continuous surveillance, assessment and approval of factory production control.

Note: Approved bodies are also referred to as "notified bodies".

3.2 Responsibilities

3.2.1 Tasks for the manufacturer

3.2.1.1 Factory production control

The manufacturer shall exercise permanent internal control of production. All the elements, requirements and provisions adopted by the manufacturer shall be documented in a systematic manner in the form of written policies and procedures, including records of results performed. This production control system shall insure that the product is in conformity with this European technical approval.

The manufacturer may only use initial/raw/constituent materials stated in the technical documentation of this European technical approval.

The factory production control shall be in accordance with the control plan which is part of the technical documentation of this European technical approval. The control plan is laid down in the context of the factory production control system operated by the manufacturer and deposited with Deutsches Institut für Bautechnik.⁹

The results of factory production control shall be recorded and evaluated in accordance with the provisions of the control plan.

3.2.1.2 Other tasks for the manufacturer

The manufacturer shall, on the basis of a contract, involve a body which is approved for the tasks referred to in section 3.1 in the field of anchors in order to undertake the actions laid down in section 3.2.2 For this purpose, the control plan referred to in sections 3.2.1.1 and 3.2.2 shall be handed over by the manufacturer to the approved body involved.

The manufacturer shall make a declaration of conformity, stating that the construction product is in conformity with the provisions of this European technical approval.

⁸ Official Journal of the European Communities L 254 of 08.10.1996

⁹ The control plan is a confidential part of the European technical approval and only handed over to the approved body involved in the procedure of attestation of conformity. See section 3.2.2.

3.2.2 Tasks for the approved bodies

The approved body shall perform the

- initial type-testing of the product,
 - initial inspection of factory and of factory production control,
 - continuous surveillance, assessment and approval of factory production control
- in accordance with the provisions laid down in the control plan.

The approved body shall retain the essential points of its actions referred to above and state the results obtained and conclusions drawn in a written report.

The approved certification body involved by the manufacturer shall issue an EC certificate of conformity of the product stating the conformity with the provisions of this European technical approval.

In cases where the provisions of the European technical approval and its control plan are no longer fulfilled the certification body shall withdraw the certificate of conformity and inform Deutsches Institut für Bautechnik without delay.

3.3 CE marking

The CE marking shall be affixed on the ...(product itself - indicate where on the product, if necessary - or the label attached to it; packaging; accompanying commercial document, e.g. the EC declaration of conformity). The letters "CE" shall be followed by the identification number of the approved certification body, where relevant, and be accompanied by the following additional information:

- the name and address of the producer (legal entity responsible for the manufacture),
- the last two digits of the year in which the CE marking was affixed,
- the number of the EC certificate of conformity for the product,
- the number of the European technical approval,
- the number of the guideline for European technical approval,
- use category (ETAG 001-1, option 7),
- size.

4 Assumptions under which the fitness of the product for the intended use was favourably assessed

4.1 Manufacturing

The European technical approval is issued for the product on the basis of agreed data/information, deposited with Deutsches Institut für Bautechnik, which identifies the product that has been assessed and judged. Changes to the product or production process, which could result in this deposited data/information being incorrect, should be notified to Deutsches Institut für Bautechnik before the changes are introduced. Deutsches Institut für Bautechnik will decide whether or not such changes affect the approval and consequently the validity of the CE marking on the basis of the approval and if so whether further assessment or alterations to the approval shall be necessary.

4.2 Design of anchorages

The fitness of the anchor for the intended use is given under the following conditions:

The anchorages are designed in accordance with the "Guideline for European technical approval of Metal Anchors for Use in Concrete", Annex C, Method A under the responsibility of an engineer experienced in anchorages and concrete work.

Verifiable calculation notes and drawings are prepared taking account of the loads to be anchored.

The position of the anchor is indicated on the design drawings (e. g. position of the anchor relative to reinforcement or to supports).

The minimum strength class and the minimum screwing depth of the fastening screw or the threaded rod for installation of the fixture shall meet the requirements according to Annex 5. The length of the fastening screw shall be defined taking into account available thread length, the minimum screwing depth, the thickness of fixture and tolerances of member and fixture.

4.3 Installation of anchors

The fitness for use of the anchor can only be assumed if the anchor is installed as follows:

- Anchor installation carried out by appropriately qualified personnel and under the supervision of the person responsible for technical matters of the site.
- Use of the anchor only as supplied by the manufacturer without exchanging the components of an anchor.
- Checks before placing the anchor to ensure that the strength class of the concrete in which the anchor is to be placed is in the range given and is not lower than that of the concrete to which the characteristic loads apply.
- Check of concrete being well compacted, e. g. without significant voids.
- Positioning of the drill holes without damaging the reinforcement.
- Drill hole by hammer drilling only.
- Cleaning of the hole of drilling dust.
- Edge distance and spacing not less than the specified values without minus tolerances.
- In case of aborted hole: new drilling at a minimum distance away of twice the depth of the aborted hole or smaller distance if the aborted drill hole is filled with high strength mortar and if under shear or oblique tension load it is not in the direction of load application.
- Anchor installation acc. to manufacturer's instructions given in Annex 6.
- Anchor expansion by impact on the plug using the setting tools given in Annex 4. The anchor is properly set if the stop of the pin reaches the anchor body, and the impression of the manual setting tool HSD-G is visible as illustrated in Annex 4.
- The fastening screw or threaded rod shall correspond to the requirements given in Annex 5.
- Installation torque moments are not required for functioning of the anchor. However, the torque moments given in Annex 5 must not be exceeded.

5 Indications to the manufacturer

It is in the responsibility of the manufacturer to ensure that the information on the specific conditions according to 1 and 2 including Annexes referred to as well as sections 4.2 and 4.3 is given to those who are concerned. This information may be made by reproduction of the respective parts of the European technical approval. In addition all installation data shall be shown clearly on the package and/or on an enclosed instruction sheet, preferably using illustration(s).

The minimum data required are:

- drill bit diameter,
- thread diameter,
- minimum effective anchorage depth,
- available thread length and minimum screwing depth of the fastening screw or threaded rod,
- minimum hole depth,
- torque moment,
- information on the installation procedure, including cleaning of the hole, preferably by means of an illustration,
- reference to any special installation equipment needed,
- identification of the manufacturing batch.

All data shall be presented in a clear and explicit form.

Georg Feistel
Head of Department

beglaubigt:
Baderschneider

Hilti push-in anchor HKD

for use in non-cracked concrete

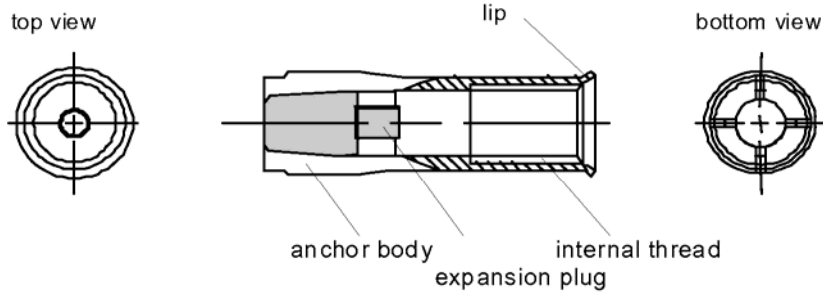

Intended use:

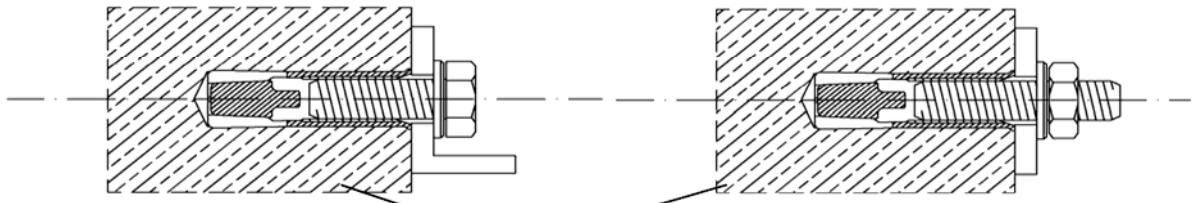

Marking:

concrete C20/25 to C50/60

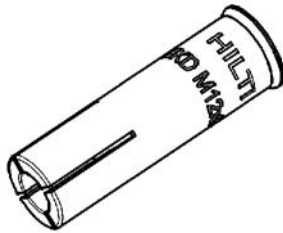

HKD

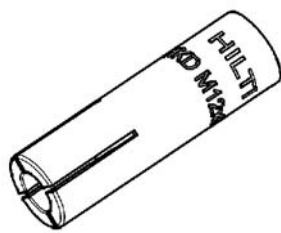

HKD-woL

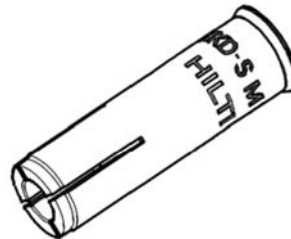

**HKD-S /
HKD-SR**

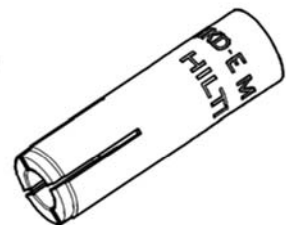

**HKD-E /
HKD-ER**

HKD

- HKD M8 x 30
- HKD M8 x 40
- HKD M10 x 30
- HKD M10 x 40
- HKD M12 x 50
- HKD M16 x 65
- HKD M20 x 80

HKD-woL

- HKD-woL M8 x 30
- HKD-woL M8 x 40
- HKD-woL M10 x 30
- HKD-woL M10 x 40
- HKD-woL M12 x 50
- HKD-woL M16 x 65
- HKD-woL M20 x 80

HKD-S

- HKD-S M6 x 30 ø8
- HKD-S M8 x 30 ø10
- HKD-S M8 x 40 ø10
- HKD-S M10 x 30 ø12
- HKD-S M10 x 40 ø12
- HKD-S M12 x 50 ø15
- HKD-S M16 x 65 ø20
- HKD-S M20 x 80 ø25

HKD-SR

- HKD-SR M6 x 30 ø8
- HKD-SR M8 x 30 ø10
- HKD-SR M10 x 40 ø12
- HKD-SR M12 x 50 ø15

HKD-E

- HKD-E M6 x 30 ø8
- HKD-E M8 x 30 ø10
- HKD-E M8 x 40 ø10
- HKD-E M10 x 30 ø12
- HKD-E M10 x 40 ø12
- HKD-E M12 x 50 ø15
- HKD-E M16 x 65 ø20
- HKD-E M20 x 80 ø25

HKD-ER

- HKD-ER M6 x 30 ø8
- HKD-ER M8 x 30 ø8
- HKD-ER M10 x 40 ø12
- HKD-ER M12 x 50 ø15











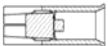

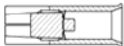

Hilti push-in anchor HKD

Product and intended use

Annex 1

Identification after installation

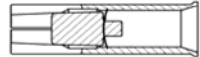
Table 1: Identification HKD and HKD-woL

Size		setting tool	top view
HKD M8x30		HSD-G M8 x 25/30	
HKD M8x40		HSD-G M8 x 40	
HKD M10x30		HSD-G M10 x 25/30	
HKD M10x40		HSD-G M10 x 40	
HKD M12x50		HSD-G M12 x 50	
HKD M16x65		HSD-G M16 x 65	
HKD M20x80		HSD-G M20 x 80	

Identification HKD-E(R) and HKD-S(R)

each anchor can be identified with setting tool after installation

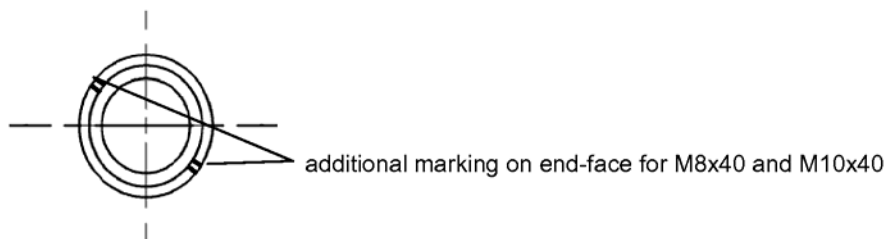

Hilti push-in anchor HKD

Identification after installation

Annex 2

Table 2: Materials

HKD; HKD-woL		
designation		material
1	anchor body	cold formed steel – galvanised to $\geq 5 \mu\text{m}$, EN 10084 or EN 10111
2	expansion plug	cold formed steel, EN 10084 or EN 10111
HKD-S; HKD-E		
designation		material
1	anchor body	steel Fe/Zn5 (galvanised to $\geq 5 \mu\text{m}$), EN 10087, EN 10277-3
2	expansion plug	steel 1.0213, EN 10263-2 or steel 1.0204, DIN 17111
HKD-SR; HKD-ER		
designation		material
1	anchor body	stainless steel, 1.4401, 1.4404 or 1.4571 EN 10088-3
2	expansion plug	

① anchor body

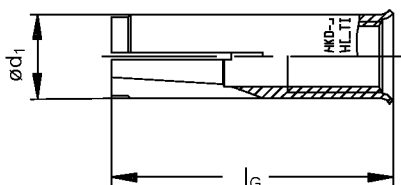

② expansion plug

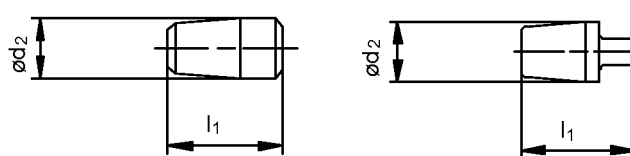

Table 3: Dimensions

anchor size	l_G [mm]	$\varnothing d_1$ [mm]	$\varnothing d_2$ [mm]	l_1 [mm]
M6x30	30	8	5	15
M8x30	30	9,95	6,5	12
M8x40	40	9,95	6,35	16
M10x30	30	11,80	8,2	12
M10x40	40	11,95	8,2	16
M12x50	50	14,90	10,3	20
M16x65	60	19,75	13,8	29
M20x80	80	24,75	16,4	30

Hilti push-in anchor HKD

Materials and dimensions

Annex 3

Manual setting tool HSD-G M.. x h_{ef}

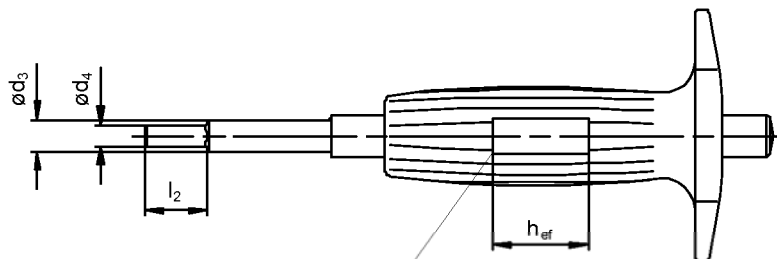

Installation control with
manual setting tool

anchor gauge with imprint M..x h_{ef} (assigned anchor)
the recess length corresponds to the anchor length h_{ef}

Machine setting tool HSD-M M.. x h_{ef}



marking HSD-M M..x h_{ef} (assigned anchor)

Machine setting tool HSD-TE CX M.. x h_{ef}

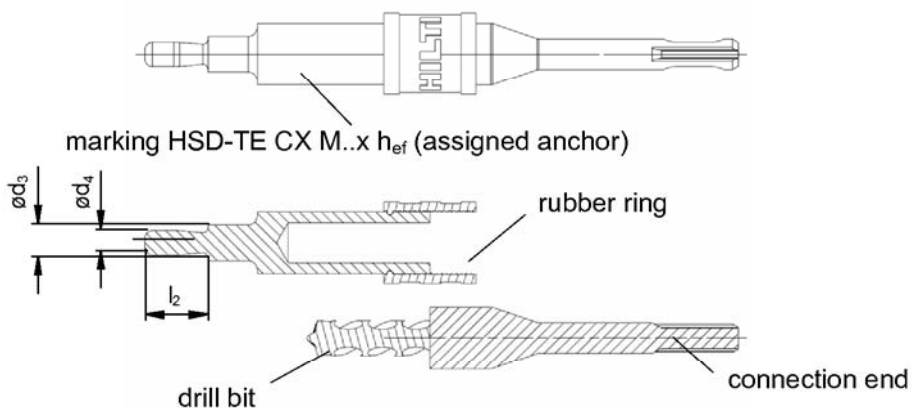

marking HSD-TE CX M..x h_{ef} (assigned anchor)

Table 4: Dimensions of the setting tools

setting tool HSD / HSG	$\varnothing d_3$ [mm]	$\varnothing d_4$ [mm]	l_2 [mm]
M6x30	7,5	5,0	15
M8x30	9,5	6,5	18
M8x40	9,5	6,5	28
M10x30	11,5	8,0	18
M10x40	11,5	8,0	24
M12x50	14,5	10,2	30
M16x65	18,0	13,5	36
M20x80	22,0	16,5	50

Hilti push-in anchor HKD

Setting tools

Annex 4

Installation data

Fastening screw or threaded rod:

For anchor made of galvanised steel (HKD, HKD-woL, HKD-E and HKD-S) the property class is 4.6 / 5.6 / 5.8 or 8.8 according to EN ISO 898-1 to use.

For anchor made of stainless steel (HKD-ER and HKD-SR) the minimum property class is A4-70 according to EN ISO 3506 to use.

Minimum screw depth $l_{s,min}$: The length of the screw shall be determined depending on thickness of fixture t_{fix} , admissible tolerances and available thread length $l_{s,max}$ as well as minimum screw depth $l_{s,min}$.

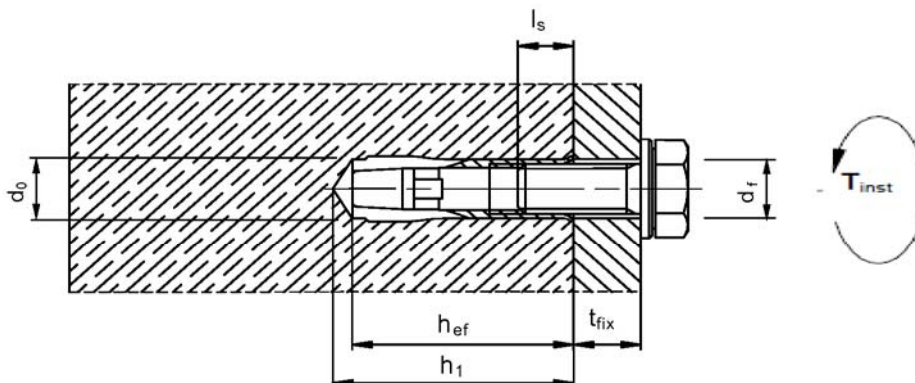

Table 5: Installation data

anchor size	drill hole diameter	thread diameter	drill hole depth	effective anchorage depth	maximum-screwing depth	minimum-screwing depth	tightening torque	clearance hole diameter
	d_0 [mm]	d [mm]	h_1 [mm]	h_{ef} [mm]	$l_{s,max}$ [mm]	$l_{s,min}$ [mm]	max. T_{inst} [Nm]	d_f [mm]
M6x30	8	6	32	30	12,5	6	≤ 4	7
M8x30	10	8	33	30	14,5	8	≤ 8	9
M8x40	10	8	43	40	17,5	8	≤ 8	9
M10x30 ¹⁾	12	10	33	30	12,7	10	≤ 15	12
M10x40	12	10	43	40	18,0	10	≤ 15	12
M12x50	15	12	54	50	23,5	12	≤ 35	14
M16x65	20	16	70	65	30,5	16	≤ 60	18
M20x80	25	20	85	80	42,0	20	≤ 100	22

¹⁾ with anchor size M10x30 **only** threaded rod is to be used

Hilti push-in anchor HKD

Installation data

Annex 5

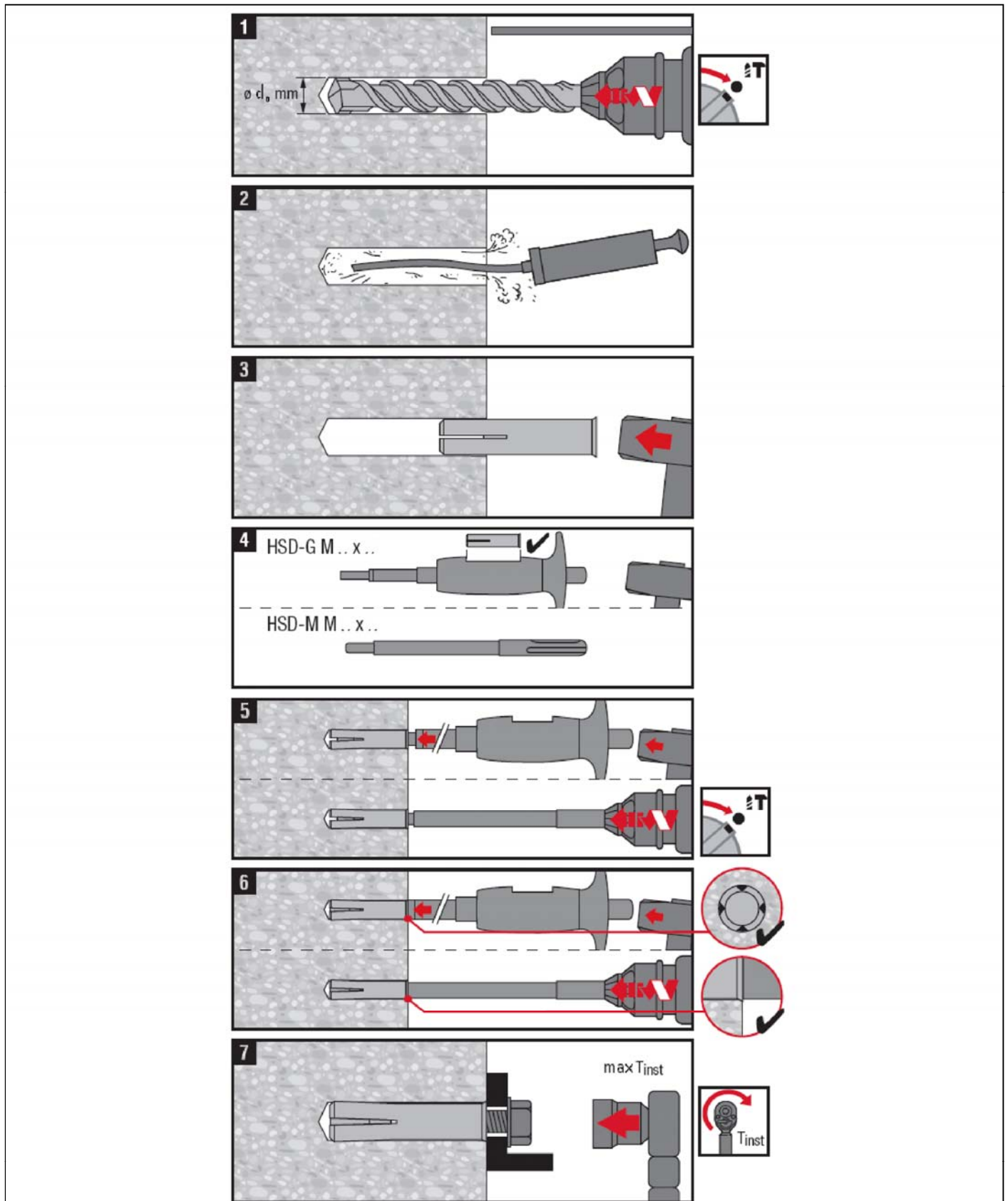

Hilti push-in anchor HKD

Instruction for use

Annex 6

Table 6: Installation for minimum spacing and minimum edge distance

HKD-S, HKD-E, HKD-SR and HKD-ER			M6x30 M8x30 M10x30	M8x40 M10x40	M12x50	M16x65	M20x80
minimum thickness of concrete member	h_{min}	[mm]	100	100	100	130	160
minimum spacing	s_{min}	[mm]	60	80	125	130	160
minimum edge distance	c_{min}	[mm]	105	140	175	230	280
HKD, HKD-woL			M8x30 M10x30	M8x40 M10x40	M12x50	M16x65	M20x80
Minimum thickness of concrete member	h_{min}	[mm]	100	100	100	130	160
minimum spacing	s_{min}	[mm]	60	80	125	130	160
	for $c \geq$	[mm]	105	140	175	230	280
minimum edge distance	c_{min}	[mm]	120	140	175	230	280
	for $s \geq$	[mm]	80	80	125	130	160

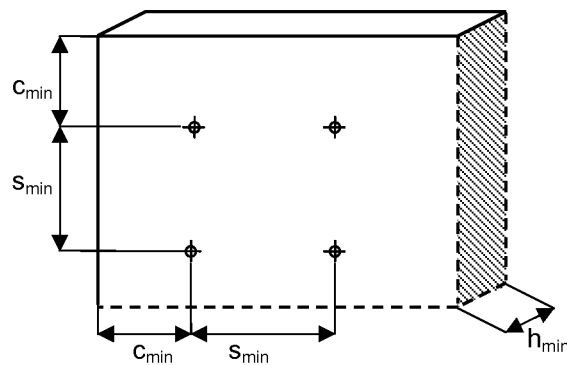

Hilti push-in anchor HKD

Minimum spacing and edge distance

Annex 7

Table 7: Design method A - Characteristic resistance to tension loads

HKD-S (R) HKD-E (R)			M6x30 ⁴⁾	M8x30 ⁴⁾	M10x30 ⁴⁾	M8x40	M10x40	M12x50	M16x65	M20x80	
Steel failure											
Characteristic resistance	$N_{Rk,s}$ [kN]	steel 4.6	8,0	14,6	23,2	14,6	23,2	33,7	62,8	98,0	
Partial safety factor	γ_{Ms} ¹⁾		2,0								
Characteristic resistance	$N_{Rk,s}$ [kN]	steel 5.6	10,1	18,3	18,5	18,3	19,9	42,2	54,7	86,9	
Partial safety factor	γ_{Ms} ¹⁾		2,0	2,0	1,49	2,0	1,49	2,0	1,47	1,47	
Characteristic resistance	$N_{Rk,s}$ [kN]	steel 5.8	10,1	17,4	18,5	17,4	19,9	35,3	54,7	86,9	
Partial safety factor	γ_{Ms} ¹⁾		1,50	1,53	1,49	1,53	1,49	1,49	1,47	1,47	
Characteristic resistance	$N_{Rk,s}$ [kN]	steel 8.8	13,4	17,4	18,5	17,4	19,9	35,3	54,7	86,9	
Partial safety factor	γ_{Ms} ¹⁾		1,53	1,53	1,49	1,53	1,49	1,49	1,47	1,47	
Characteristic resistance	$N_{Rk,s}$ [kN]	A4-70	12,8	16,8	-	-	21,1	37,3	64,2	102,0	
Partial safety factor	γ_{Ms} ¹⁾		1,83								
Pull-out failure											
Characteristic resistance	$N_{Rk,p}$ [kN]	C20/25	-- ⁵⁾			9,0	-- ⁵⁾				
Partial safety factor in Non-cracked concrete	γ_{Mp} ¹⁾					1,8 ²⁾					
Increasing factors for $N_{Rk,p}$	ψ_c	C30/37	1,22								
		C40/50	1,41								
		C50/60	1,55								
Concrete cone and splitting failure											
Effective anchorage depth	h_{ef}	[mm]	30 ⁴⁾	30 ⁴⁾	30 ⁴⁾	40	40	50	65	80	
Partial safety factor in Non-cracked concrete	$\gamma_{Mc} = \gamma_{M,sp}$ ¹⁾		1,8 ²⁾						1,5 ³⁾		
Spacing	$s_{cr,N}$	[mm]	90	90	90	120	120	150	195	240	
Edge distance	$c_{cr,N}$	[mm]	45	45	45	60	60	75	97	120	
Spacing	$s_{cr,sp}$	[mm]	210	210	210	280	280	350	455	560	
Edge distance	$c_{cr,sp}$	[mm]	105	105	105	140	140	175	227	280	

¹⁾ In absence of other national regulations;

²⁾ $\gamma_2 = 1,2$ is included;

³⁾ $\gamma_2 = 1,0$ is included

⁴⁾ For application with statically indeterminate structural components only

⁵⁾ Pull-out failure mode is not decisive

Hilti push-in anchor HKD

Characteristic resistance to tension load
HKD- S(R) and HKD- E(R)

Annex 8

Tabelle 8: Design method A - Characteristic resistance to tension loads

HKD HKD wol			M8x30 ³⁾	M10x30 ³⁾	M8x40	M10x40	M12x50	M16x65	M20x80
Steel failure									
Characteristic resistance	$N_{Rk,s}$ [kN]	steel 4.6	14,6	19,9	14,6	22,1	33,7	62,8	98,0
Partial safety factor	γ_{Ms} ¹⁾		2,0	1,5	2,0	1,5	2,0		
Characteristic resistance	$N_{Rk,s}$ [kN]	steel 5.6	17,1	19,9	19,4	22,1	36,6	67,5	99,0
Partial safety factor	γ_{Ms} ¹⁾		1,5						
Characteristic resistance	$N_{Rk,s}$ [kN]	steel 5.8	17,1	19,9	19,4	22,1	36,6	67,5	99,0
Partial safety factor	γ_{Ms} ¹⁾		1,5						
Characteristic resistance	$N_{Rk,s}$ [kN]	steel 8.8	17,1	19,9	19,4	22,1	36,6	67,5	99,0
Partial safety factor	γ_{Ms} ¹⁾		1,5						
Pull-out failure									
Characteristic resistance	$N_{Rk,p}$ [kN]	C20/25	-- ⁴⁾		9,0		-- ⁴⁾		
Partial safety factor in Non-cracked concrete	γ_{Mp} ¹⁾				1,5 ²⁾				
Increasing factors for $N_{Rk,p}$	ψ_c	C30/37	1,22						
		C40/50	1,41						
		C50/60	1,55						
Concrete cone and splitting failure									
Effective anchorage depth	h_{ef}	[mm]	30 ³⁾	30 ³⁾	40	40	50	65	80
Partial safety factor in Non-cracked concrete	$\gamma_{Mc} = \gamma_{M,sp}$ ¹⁾		1,5 ²⁾						
Spacing	$s_{cr,N}$	[mm]	90	90	120	120	150	195	240
Edge distance	$c_{cr,N}$	[mm]	45	45	60	60	75	97	120
Spacing	$s_{cr,sp}$	[mm]	210	210	280	280	350	455	560
Edge distance	$c_{cr,sp}$	[mm]	105	105	140	140	175	227	280

¹⁾ In absence of other national regulations;

²⁾ $\gamma_2 = 1,0$ is included;

³⁾ For application with statically indeterminate structural components only

⁴⁾ Pull-out failure mode is not decisive

Hilti push-in anchor HKD

Characteristic resistance to tension load
HKD and HKD- wol

Annex 9

Table 9: Displacements under tension loads

HKD-S (R) HKD-E (R)			M6x30	M8x30	M10x30	M8x40	M10x40	M12x50	M16x65	M20x80
Tension load in C20/25 to C50/60 non-cracked concrete	N	[kN]	3,3	3,3	3,3	3,6	5,1	7,1	12,6	17,2
Displacement	δ_{N0}	[mm]	0,1	0,1	0,1	0,1	0,1	0,1	0,1	0,1
	$\delta_{N\infty}$	[mm]	0,2	0,2	0,2	0,2	0,2	0,2	0,2	0,2

Table 10: Displacements under tension loads

HKD HKD wol			M8x30	M10x30	M8x40	M10x40	M12x50	M16x65	M20x80
Tension load in C20/25 to C50/60 non-cracked concrete	N	[kN]	4,0	4,0	4,3	6,1	8,5	12,6	17,2
Displacement	δ_{N0}	[mm]	0,1	0,1	0,1	0,1	0,1	0,1	0,1
	$\delta_{N\infty}$	[mm]	0,3	0,3	0,3	0,3	0,3	0,2	0,2

Hilti push-in anchor HKD

Displacements under tension load

Annex 10

Table 11: Design method A - Characteristic resistance to shear loads

HKD-S HKD-E			M6x30	M8x30	M10x30	M8x40	M10x40	M12x50	M16x65	M20x80
Steel failure without lever arm										
Characteristic resistance	$V_{Rk,s}$ [kN]	steel 4.6	4,0	7,3	7,4	7,3	8,0	16,9	21,9	34,7
Partial safety factor	$\gamma_{Ms}^{1)}$		1,67	1,67	1,25	1,67	1,25	1,67	1,25	1,25
Characteristic resistance	$V_{Rk,s}$ [kN]	steel 5.6	5,0	7,0	7,4	7,0	8,0	14,1	21,9	34,7
Partial safety factor	$\gamma_{Ms}^{1)}$		1,67	1,27	1,25	1,27	1,25	1,25	1,25	1,25
Characteristic resistance	$V_{Rk,s}$ [kN]	steel 5.8	5,0	7,0	7,4	7,0	8,0	14,1	21,9	34,7
Partial safety factor	$\gamma_{Ms}^{1)}$		1,25	1,27	1,25	1,27	1,25	1,25	1,25	1,25
Characteristic resistance	$V_{Rk,s}$ [kN]	steel 8.8	5,3	7,0	7,4	7,0	8,0	14,1	21,9	34,7
Partial safety factor	$\gamma_{Ms}^{1)}$		1,27	1,27	1,25	1,27	1,25	1,25	1,25	1,25
Characteristic resistance	$V_{Rk,s}$ [kN]	A4-70	6,4	8,4	-	-	10,5	18,7	32,1	51,0
Partial safety factor	$\gamma_{Ms}^{1)}$		1,52	1,52	-	-	1,52	1,52	1,52	1,52
Steel failure with lever arm										
Characteristic resistance	$M_{Rk,s}^0$ [Nm]	steel 4.6	6	15	30	15	30	52	133	260
Partial safety factor	$\gamma_{Ms}^{1)}$		1,67							
Characteristic resistance	$M_{Rk,s}^0$ [Nm]	steel 5.6	8	19	37	19	37	65	166	325
Partial safety factor	$\gamma_{Ms}^{1)}$		1,67							
Characteristic resistance	$M_{Rk,s}^0$ [Nm]	steel 5.8	8	19	37	19	37	65	166	325
Partial safety factor	$\gamma_{Ms}^{1)}$		1,25							
Characteristic resistance	$M_{Rk,s}^0$ [Nm]	steel 8.8	12	30	60	30	60	105	266	519
Partial safety factor	$\gamma_{Ms}^{1)}$		1,25							
Characteristic resistance	$M_{Rk,s}^0$ [Nm]	A4-70	11	26	-	-	52	92	233	454
Partial safety factor	$\gamma_{Ms}^{1)}$		1,56		-		1,56			
Concrete pryout failure										
Factor in equation (5.6) ETAG Annex C, §5.2.3.3	k		2,0							
Partial safety factor	$\gamma_{Mcp}^{1)}$		1,5 ²⁾							
Concrete edge failure										
Effective length of anchor	l_f	[mm]	30	30	30	40	40	50	65	80
External diameter of anchor	d_{nom}	[mm]	8	10	12	10	12	15	20	25
Partial safety factor	$\gamma_{Mc}^{1)}$		1,5 ²⁾							

¹⁾ In absence of other national regulations

²⁾ $\gamma_2 = 1,0$ is included

Hilti push-in anchor HKD

Characteristic resistance to shear load
HKD- S(R) and HKD- E(R)

Annex 11

Table 12: Design method A - Characteristic resistance to shear loads

HKD HKD-woL		M8x30	M10x30	M8x40	M10x40	M12x50	M16x65	M20x80	
Steel failure without lever arm									
Characteristic resistance	$V_{Rk,s}$ [kN]	steel 4.6	7,3	10,0	7,3	11,0	16,9	31,4	49
Partial safety factor	$\gamma_{Ms}^{1)}$		1,67	1,25	1,67	1,25	1,67	1,67	1,67
Characteristic resistance	$V_{Rk,s}$ [kN]	steel 5.6	8,6	10,0	9,2	11,0	18,3	33,8	49,5
Partial safety factor	$\gamma_{Ms}^{1)}$		1,25	1,25	1,67	1,25	1,25	1,25	1,25
Characteristic resistance	$V_{Rk,s}$ [kN]	steell 5.8	8,6	10,0	9,2	11,0	18,3	33,8	49,5
Partial safety factor	$\gamma_{Ms}^{1)}$		1,25	1,25	1,25	1,25	1,25	1,25	1,25
Characteristic resistance	$V_{Rk,s}$ [kN]	steel 8.8	8,6	10,0	9,2	11,0	18,3	33,8	49,5
Partial safety factor	$\gamma_{Ms}^{1)}$		1,25	1,25	1,25	1,25	1,25	1,25	1,25
Steel failure with lever arm									
Characteristic resistance	$M_{Rk,s}^0$ [Nm]	steel 4.6	15	30	15	30	52	133	260
Partial safety factor	$\gamma_{Ms}^{1)}$		1,67						
Characteristic resistance	$M_{Rk,s}^0$ [Nm]	steel 5.6	19	37	19	37	65	166	325
Partial safety factor	$\gamma_{Ms}^{1)}$		1,67						
Characteristic resistance	$M_{Rk,s}^0$ [Nm]	steel 5.8	19	37	19	37	65	166	325
Partial safety factor	$\gamma_{Ms}^{1)}$		1,25						
Characteristic resistance	$M_{Rk,s}^0$ [Nm]	steel 8.8	30	60	30	60	105	266	519
Partial safety factor	$\gamma_{Ms}^{1)}$		1,25						
Concrete pryout failure									
Factor in equation (5.6) ETAG Annex C, §5.2.3.3	k		2,0						
Partial safety factor	$\gamma_{Mcp}^{1)}$		1,5 ²⁾						
Concrete edge failure									
Effective length of anchor	l_f	[mm]	30	30	40	40	50	65	80
External diameter of anchor	d_{nom}	[mm]	10	12	10	12	15	20	25
Partial safety factor	$\gamma_{Mc}^{1)}$		1,5 ²⁾						

¹⁾ In absence of other national regulations

³⁾ $\gamma_2 = 1,0$ is included

Hilti push-in anchor HKD

Characteristic resistance to shear load
HKD and HKD- woL

Annex 12

Table 13: Displacement under shear load

HKD-S HKD-E		M6x30	M8x30	M10x30	M8x40	M10x40	M12x50	M16x65	M20x80
Shear load in C20/25 to C50/60 non-cracked concrete	V [kN]	1,7	3,1	4,3	3,1	4,6	7,2	12,5	19,8
Displacement	δ_{V0} [mm]	0,35	0,35	0,35	0,40	0,40	0,45	0,75	0,75
	$\delta_{V\infty}$ [mm]	0,50	0,50	0,50	0,60	0,60	0,70	1,1	1,1

Table 14: Displacement under shear load

HKD-SR HKD-ER		M6x30	M8x30	M10x40	M12x50	M16x65	M20x80
Shear load in C20/25 to C50/60 non-cracked concrete	V [kN]	1,7	3,9	4,9	8,8	15,1	24,0
Displacement	δ_{V0} [mm]	0,35	0,45	0,45	0,55	0,9	0,9
	$\delta_{V\infty}$ [mm]	0,50	0,65	0,65	0,85	1,3	1,3

Table 15: Displacement under shear load

HKD HKD wol		M8x30	M10x30	M8x40	M10x40	M12x50	M16x65	M20x80
Shear load in C20/25 to C50/60 non-cracked concrete	V [kN]	3,1	4,3	3,1	4,6	7,2	12,5	19,8
Displacement	δ_{V0} [mm]	0,35	0,35	0,40	0,40	0,45	0,75	0,75
	$\delta_{V\infty}$ [mm]	0,50	0,50	0,60	0,60	0,70	1,1	1,1

Hilti push-in anchor HKD

Displacements under shear load

Annex 13