

## European Technical Approval ETA-12/0028

English translation prepared by DIBt - Original version in German language

Handelsbezeichnung  
*Trade name*

Injektionssystem Hilti HIT-HY 200-R mit HIT-Z / HIT-Z-R  
*Injection system Hilti HIT-HY 200-R with HIT-Z / HIT-Z-R*

Zulassungsinhaber  
*Holder of approval*

Hilti AG  
Feldkircherstraße 100  
9494 Schaan  
FÜRSTENTUM LIECHTENSTEIN

Zulassungsgegenstand  
und Verwendungszweck  
*Generic type and use  
of construction product*

Verbunddübel in den Größen M8 bis M20 zur Verankerung im Beton  
*Bonded anchor of sizes M8 to M20 for use in concrete*

Geltungsdauer:  
*Validity:*

vom  
*from*  
bis  
*to*

28 September 2012  
10 February 2017

Herstellwerk  
*Manufacturing plant*

Hilti Werke

Diese Zulassung umfasst  
*This Approval contains*

18 Seiten einschließlich 10 Anhänge  
*18 pages including 10 annexes*

Diese Zulassung ersetzt  
*This Approval replaces*

ETA-12/0028 mit Geltungsdauer vom 04.04.2012 bis 10.02.2017  
*ETA-12/0028 with validity from 04.04.2012 to 10.02.2017*

## I LEGAL BASES AND GENERAL CONDITIONS

- 1 This European technical approval is issued by Deutsches Institut für Bautechnik in accordance with:
  - Council Directive 89/106/EEC of 21 December 1988 on the approximation of laws, regulations and administrative provisions of Member States relating to construction products<sup>1</sup>, modified by Council Directive 93/68/EEC<sup>2</sup> and Regulation (EC) N° 1882/2003 of the European Parliament and of the Council<sup>3</sup>;
  - *Gesetz über das In-Verkehr-Bringen von und den freien Warenverkehr mit Bauprodukten zur Umsetzung der Richtlinie 89/106/EWG des Rates vom 21. Dezember 1988 zur Angleichung der Rechts- und Verwaltungsvorschriften der Mitgliedstaaten über Bauprodukte und anderer Rechtsakte der Europäischen Gemeinschaften (Bauproduktengesetz - BauPG) vom 28. April 1998<sup>4</sup>, as amended by Article 2 of the law of 8 November 2011<sup>5</sup>;*
  - Common Procedural Rules for Requesting, Preparing and the Granting of European technical approvals set out in the Annex to Commission Decision 94/23/EC<sup>6</sup>;
  - Guideline for European technical approval of "Metal anchors for use in concrete - Part 5: Bonded anchors", ETAG 001-05.
- 2 Deutsches Institut für Bautechnik is authorized to check whether the provisions of this European technical approval are met. Checking may take place in the manufacturing plant. Nevertheless, the responsibility for the conformity of the products to the European technical approval and for their fitness for the intended use remains with the holder of the European technical approval.
- 3 This European technical approval is not to be transferred to manufacturers or agents of manufacturers other than those indicated on page 1, or manufacturing plants other than those indicated on page 1 of this European technical approval.
- 4 This European technical approval may be withdrawn by Deutsches Institut für Bautechnik, in particular pursuant to information by the Commission according to Article 5(1) of Council Directive 89/106/EEC.
- 5 Reproduction of this European technical approval including transmission by electronic means shall be in full. However, partial reproduction can be made with the written consent of Deutsches Institut für Bautechnik. In this case partial reproduction has to be designated as such. Texts and drawings of advertising brochures shall not contradict or misuse the European technical approval.
- 6 The European technical approval is issued by the approval body in its official language. This version corresponds fully to the version circulated within EOTA. Translations into other languages have to be designated as such.

<sup>1</sup> Official Journal of the European Communities L 40, 11 February 1989, p. 12  
<sup>2</sup> Official Journal of the European Communities L 220, 30 August 1993, p. 1  
<sup>3</sup> Official Journal of the European Union L 284, 31 October 2003, p. 25  
<sup>4</sup> *Bundesgesetzblatt Teil I 1998*, p. 812  
<sup>5</sup> *Bundesgesetzblatt Teil I 2011*, p. 2178  
<sup>6</sup> Official Journal of the European Communities L 17, 20 January 1994, p. 34

## II SPECIFIC CONDITIONS OF THE EUROPEAN TECHNICAL APPROVAL

### 1 Definition of product and intended use

#### 1.1 Definition of the construction product

The injection system Hilti HIT-HY 200-R with HIT-Z / HIT-Z-R is a bonded anchor consisting of a foil pack with injection mortar Hilti HIT-HY 200-R and an anchor rod (including nut and washer) in the sizes of M8, M10, M12, M16 and M20. The anchor rod (including nut and washer) is made of galvanised steel (HIT-Z) or stainless steel (HIT-Z-R). The anchor rod is placed into a drill hole filled with injection mortar. The load transfer is realised by mechanical interlock of several cones in the bonding mortar and then via a combination of bonding and friction forces in the base material (concrete).

An illustration of the product and intended use is given in Annex 1.

#### 1.2 Intended use

The anchor is intended to be used for anchorages for which requirements for mechanical resistance and stability and safety in use in the sense of the Essential Requirements 1 and 4 of Council Directive 89/106 EEC shall be fulfilled and failure of anchorages made with these products would cause risk to human life and/or lead to considerable economic consequences. Safety in case of fire (Essential Requirement 2) is not covered in this European technical approval. The anchor is to be used only for anchorages subject to static or quasi-static loading in reinforced or unreinforced normal weight concrete of strength classes C20/25 at minimum and C50/60 at most according to EN 206:2000-12.

The anchor may be anchored in cracked and non-cracked concrete.

The anchor may be installed in dry or wet concrete; it must not be installed in flooded holes.

The anchor may be used in the following temperature ranges:

- Temperature range I: -40 °C to +40 °C (max long term temperature +24 °C and max short term temperature +40 °C)
- Temperature range II: -40 °C to +80 °C (max long term temperature +50 °C and max short term temperature +80 °C)
- Temperature range III: -40 °C to +120 °C (max long term temperature +72 °C and max short term temperature +120 °C)

#### Anchor rods HIT-Z (galvanised steel):

The anchor rod (including nut and washer) made of galvanised steel may only be used in structures subject to dry internal conditions.

Anchor rods HIT-Z-R (stainless steel 1.4401, 1.4404):

The anchor rod (including nut and washer) made of stainless steel may be used in structures subject to dry internal conditions and also in structures subject to external atmospheric exposure (including industrial and marine environment), or exposure in permanently damp internal conditions, if no particular aggressive conditions exist. Such particular aggressive conditions are e.g. permanent, alternating immersion in seawater or the splash zone of seawater, chloride atmosphere of indoor swimming pools or atmosphere with extreme chemical pollution (e.g. in desulphurization plants or road tunnels where de-icing materials are used).

The provisions made in this European technical approval are based on an assumed intended working life of the anchor of 50 years. The indications given on the working life cannot be interpreted as a guarantee given by the producer, but are to be regarded only as a means for choosing the right products in relation to the expected economically reasonable working life of the works.

## 2 Characteristics of product and methods of verification

### 2.1 Characteristics of product

The anchor corresponds to the drawings and provisions given in Annexes 1, 2 and 4. The characteristic material values, dimensions and tolerances of the anchor not indicated in Annexes 1, 2 and 4 shall correspond to the respective values laid down in the technical documentation<sup>7</sup> of this European technical approval.

The characteristic values for the design of anchorages are given in Annexes 8 to 10.

Each anchor rod shall be marked according to Annex 1 with the identifying mark of the manufacturer, with the anchor size, with the anchorage depth, with the maximum fixture thickness and with the letters "HIT-Z" for galvanised steel or "HIT-Z-R" for stainless steel respectively.

The two components of the injection mortar are delivered in unmixed condition in foil packs of sizes 330 ml or 500 ml according to Annex 1. Each foil pack is marked with the identifying mark "HY 200-R", with the batch number and expiry date.

### 2.2 Methods of verification

The assessment of fitness of the anchor for the intended use in relation to the requirements for mechanical resistance and stability and safety in use in the sense of the Essential Requirements 1 and 4 has been made in accordance with the "Guideline for European technical approval of Metal Anchors for Use in Concrete", Part 1 "Anchors in general" and Part 5 "Bonded anchors" on the basis of Option 1.

In addition to the specific clauses relating to dangerous substances contained in this European technical approval, there may be other requirements applicable to the products falling within its scope (e.g. transposed European legislation and national laws, regulations and administrative provisions). In order to meet the provisions of the EU Construction Products Directive, these requirements need also to be complied with, when and where they apply.

<sup>7</sup> The technical documentation of this European technical approval is deposited at the Deutsches Institut für Bautechnik and, as far as relevant for the tasks of the approved bodies involved in the attestation of conformity procedure, is handed over to the approved bodies.

### 3 Evaluation and attestation of conformity and CE marking

#### 3.1 System of attestation of conformity

According to the decision 96/582/EG of the European Commission<sup>8</sup> the system 2(i) (referred to as System 1) of attestation of conformity applies.

This system of attestation of conformity is defined as follows:

System 1: Certification of the conformity of the product by an approved certification body on the basis of:

- (a) Tasks for the manufacturer:
  - (1) factory production control;
  - (2) further testing of samples taken at the factory by the manufacturer in accordance with a prescribed control plan.
- (b) Tasks for the approved body:
  - (3) initial type-testing of the product;
  - (4) initial inspection of factory and of factory production control;
  - (5) continuous surveillance, assessment and approval of factory production control.

Note: Approved bodies are also referred to as "notified bodies".

#### 3.2 Responsibilities

##### 3.2.1 Tasks of the manufacturer

###### 3.2.1.1 Factory production control

The manufacturer shall exercise permanent internal control of production. All the elements, requirements and provisions adopted by the manufacturer shall be documented in a systematic manner in the form of written policies and procedures, including records of results performed. This production control system shall insure that the product is in conformity with this European technical approval.

The manufacturer may only use initial / raw / constituent materials stated in the technical documentation of this European technical approval.

The factory production control shall be in accordance with the control plan which is part of the technical documentation of this European technical approval. The control plan is laid down in the context of the factory production control system operated by the manufacturer and deposited at Deutsches Institut für Bautechnik.<sup>9</sup>

The results of factory production control shall be recorded and evaluated in accordance with the provisions of the control plan.

###### 3.2.1.2 Other tasks of manufacturer

The manufacturer shall, on the basis of a contract, involve a body which is approved for the tasks referred to in section 3.1 in the field of anchors in order to undertake the actions laid down in section 3.2.2. For this purpose, the control plan referred to in sections 3.2.1.1 and 3.2.2 shall be handed over by the manufacturer to the approved body involved.

The manufacturer shall make a declaration of conformity, stating that the construction product is in conformity with the provisions of this European technical approval.

<sup>8</sup> Official Journal of the European Communities L 254 of 08.10.1996

<sup>9</sup> The control plan is a confidential part of the documentation of the European technical approval, but not published together with the European technical approval and only handed over to the approved body involved in the procedure of attestation of conformity.  
See section 3.2.2.

### 3.2.2 Tasks of approved bodies

The approved body shall perform the following tasks in accordance with the provisions laid down in the control plan:

- initial type-testing of the product,
- initial inspection of factory and of factory production control,
- continuous surveillance, assessment and approval of factory production control.

The approved body shall retain the essential points of its actions referred to above and state the results obtained and conclusions drawn in a written report.

The approved certification body involved by the manufacturer shall issue an EC certificate of conformity of the product stating the conformity with the provisions of this European technical approval.

In cases where the provisions of the European technical approval and its "control plan" are no longer fulfilled the certification body shall withdraw the certificate of conformity and inform Deutsches Institut für Bautechnik without delay.

### 3.3 CE marking

The CE marking shall be affixed on each packaging of anchors. The letters "CE" shall be followed by the identification number of the approved certification body, where relevant, and be accompanied by the following additional information:

- the name and address of the producer (legal entity responsible for the manufacturer),
- the last two digits of the year in which the CE marking was affixed,
- the number of the EC certificate of conformity for the product,
- the number of the European technical approval,
- the number of the guideline for European technical approval,
- use category (ETAG 001-1 Option 1),
- size.

## 4 Assumptions under which the fitness of the product for the intended use was favourably assessed

### 4.1 Manufacturing

The anchor is manufactured in accordance with the provisions of the European technical approval using the automated manufacturing process as identified in the inspection of the plant by the Deutsches Institut für Bautechnik and the approved body and laid down in the technical documentation.

The European technical approval is issued for the product on the basis of agreed data/information, deposited with Deutsches Institut für Bautechnik, which identifies the product that has been assessed and judged. Changes to the product or production process, which could result in this deposited data/information being incorrect, should be notified to Deutsches Institut für Bautechnik before the changes are introduced. Deutsches Institut für Bautechnik will decide whether or not such changes affect the European technical approval and consequently the validity of the CE marking on the basis of the European technical approval and if so whether further assessment or alterations to the European technical approval shall be necessary.

#### 4.2 Design of anchorages

The fitness of the anchor for the intended use is given under the following conditions:

The anchorages are designed in accordance with the EOTA Technical Report TR 029 "Design of bonded anchors"<sup>10</sup> under the responsibility of an engineer experienced in anchorages and concrete work.

Verifiable calculation notes and drawings are prepared taking account of the loads to be anchored.

The position of the anchor is indicated on the design drawings (e.g. position of the anchor relative to reinforcement or to supports, etc.).

#### 4.3 Installation of anchors

The fitness for use of the anchor can only be assumed if the anchor is installed as follows:

- anchor installation carried out by appropriately qualified personnel and under the supervision of the person responsible for technical matters of the site,
- anchor installation in accordance with the manufacturer's specifications and drawings using the tools indicated in the technical documentation of this European technical approval,
- use of the anchor only as supplied by the manufacturer without exchanging the components of an anchor,
- checks before placing the anchor to ensure that the strength class of the concrete in which the anchor is to be placed is in the range given and is not lower than that of the concrete to which the characteristic loads apply,
- check of concrete being well compacted, e.g. without significant voids,
- edge distance and spacing not less than the specified values without minus tolerances,
- positioning of the drill holes without damaging the reinforcement,
- drilling by hammer-drilling or diamond coring,
- in case of aborted drill hole: the drill hole shall be filled with mortar,
- the anchor must not be installed in flooded holes,
- keeping the installation instructions given in Annexes 5 to 7,
- the installation temperature of the mortar shall be at least +5 °C; during curing of the chemical mortar the temperature of the concrete must not fall below +5 °C; observing the curing time according to Annex 7, Table 5 until the anchor may be loaded,
- The torque moments given in Annex 2 must be observed.

### 5 Indications to the manufacturer

#### 5.1 Responsibility of the manufacturer

The manufacturer is responsible to ensure that the information on the specific conditions according to 1 and 2 including Annexes referred to and 4.2, 4.3 and 5.2 is given to those who are concerned. This information may be made by reproduction of the respective parts of the European technical approval. In addition all installation data shall be shown clearly on the package and/or on an enclosed instruction sheet, preferably using illustration(s).

<sup>10</sup> The Technical Report TR 029 "Design of bonded anchors" is published in English on EOTA website [www.eota.eu](http://www.eota.eu).



The minimum data required are:

- drill bit diameter,
- hole depth,
- diameter of anchor rod;
- maximum thickness of the fixture;
- information on the installation procedure, including cleaning of the hole with the cleaning equipments, preferably by means of an illustration,
- anchor component installation temperature,
- ambient temperature of the concrete during installation of the anchor,
- admissible working time of the mortar,
- curing time until the anchor may be loaded as a function of the ambient temperature in the concrete during installation,
- maximum torque moment,
- identification of the manufacturing batch,

All data shall be presented in a clear and explicit form.

## 5.2 Packaging, transport and storage

The foil packs shall be protected against sun radiation and shall be stored according to the manufacturer's installation instructions in dry condition at temperatures of at least +5 °C to not more than +25 °C.

Foil packs with expired shelf life must no longer be used.

The anchor shall only be packaged and supplied as a complete unit. Foil packs may be packed separately from metal parts.

Andreas Kummerow  
p. p. Head of Department

*beglaubigt:*  
Baderschneider



**Injection mortar Hilti HIT-HY 200-R:**

hybrid system with resin, hardener and cement water component

**Foil pack 330ml and 500ml**

Marking  
HY 200-R  
Batch number  
Expiry date



**Static Mixer Hilti HIT-RE-M**



**Steel elements:**

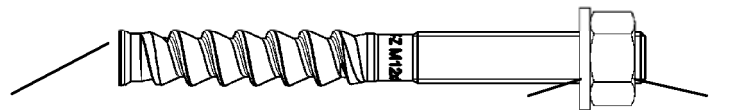

**Anchor rod HIT-Z... / HIT-Z-R...**  
Sizes M8, M10, M12, M16 and M20

washer nut

**Intended use**

**Pre-setting:**

Install anchor before positioning fixture

**Through-setting:**

Install anchor through positioned fixture

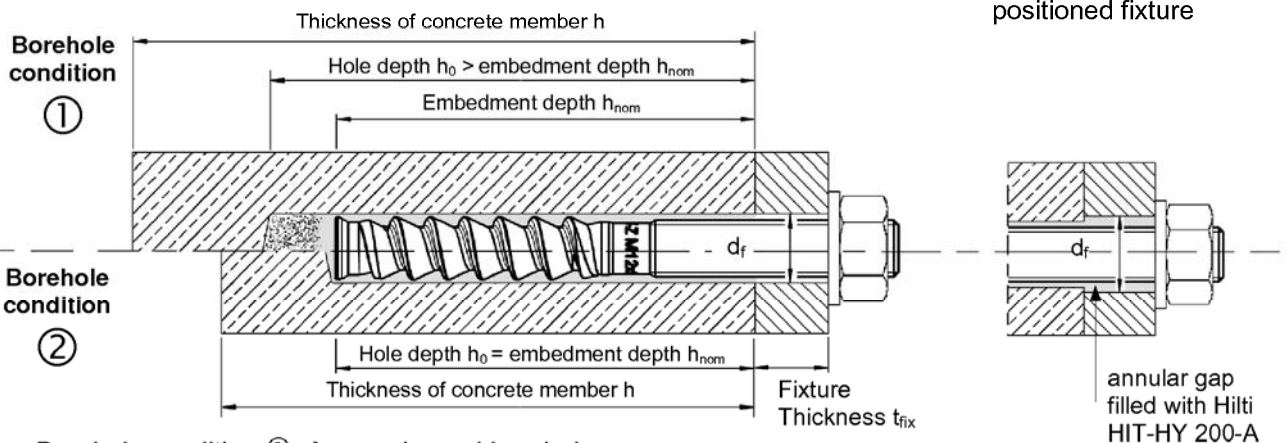

Borehole condition ① → non-cleaned borehole  
Borehole condition ② → drilling dust is completely removed

**Use category:**

Qualified for installation in:

- cracked and non-cracked concrete
- dry or wet concrete
- installation temperature +5 °C to +40 °C

Temperature range I:	-40 °C to +40 °C	(max long term temperature +24 °C and max short term temperature +40 °C)
Temperature range II:	-40 °C to +80 °C	(max long term temperature +50 °C and max short term temperature +80 °C)
Temperature range III:	-40 °C to +120 °C	(max long term temperature +72 °C and max short term temperature +120 °C)

**Injection system Hilti HIT-HY 200-R with HIT-Z / HIT-Z-R**

Intended use and use category

**Annex 1**

Anchor rod HIT-Z / HIT-Z-R

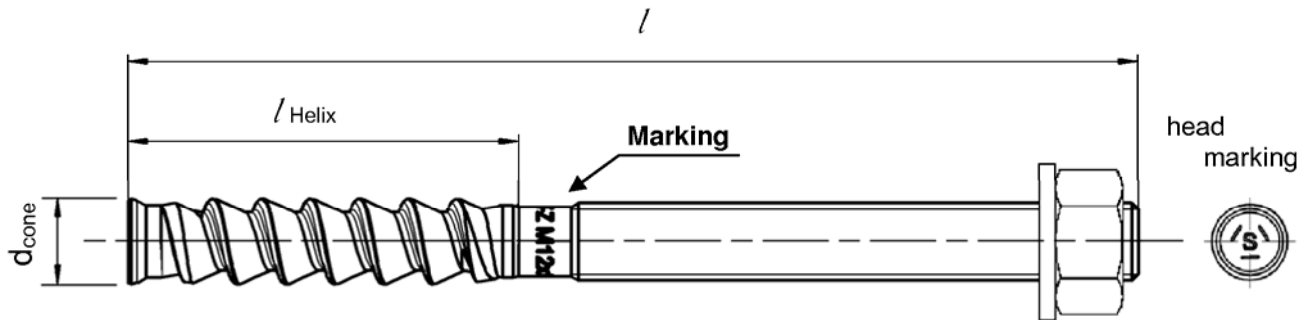

**Marking:** HIT-Z for galvanised steel; HIT-Z-R for stainless steel; M.. x /  
(e.g. HIT-Z M12x155)

**Table 1: Installation parameters**

HIT-HY 200-A with HIT-Z-...		M8	M10	M12	M16	M20
Length of anchor	min / [mm]	80	95	105	155	215
	max / [mm]	120	160	196	240	250
Length of Helix	$l_{\text{Helix}}$ [mm]	50	60	60	96	100
Nominal diameter	d [mm]	8	10	12	16	20
Diameter of anchor cone	$d_{\text{Cone}}$ [mm]	9,25	11,25	13,25	17,25	21,09
Nominal diameter of drill bit <sup>1)</sup>	$d_0$ [mm]	10	12	14	18	22
Nominal anchorage depth	$h_{\text{nom,min}}$ [mm]	60	60	60	96	100
Nominal anchorage depth	$h_{\text{nom,max}}$ [mm]	100	120	144	192	220
Borehole condition ① Min. base material thickness	$h \geq$ [mm]	$h_{\text{nom}} + 60$ mm			$h_{\text{nom}} + 100$ mm	
Borehole condition ② Min. base material thickness	$h \geq$ [mm]	$h_{\text{nom}} + 30$ mm $\geq 100$ mm			$h_{\text{nom}} + 45$ mm	
Maximum depth of borehole <sup>2)</sup>	$h_0 \leq$ [mm]	$h - 30$ mm			$h - 2 d_0$	
Pre-setting: <sup>3)</sup> Diameter of clearance hole in the fixture	$d_f \leq$ [mm]	9	12	14	18	22
Through-setting: <sup>3)</sup> Diameter of clearance hole in the fixture	$d_f \leq$ [mm]	11	14	16	20	24
Maximum fixture thickness	$t_{\text{fix,max}}$ [mm]	48	87	129	123	126
Torque moment	$T_{\text{inst}}$ [Nm]	10	25	40	80	150

<sup>1)</sup> Nominal diameter of drill bits of hammer drilling machines or diamond drilling machines

<sup>2)</sup> Check of setting depth and compress of the drilling dust (see instruction for use, Annex 5)

<sup>3)</sup> For larger diameter of clearance hole see chapter 1.1 of TR 029

**Injection system Hilti HIT-HY 200-R with HIT-Z / HIT-Z-R**

Installation parameters

**Annex 2**

### Minimum edge distance and spacing

For the calculation of minimum spacing and minimum edge distance of anchors in combination with different embedment depth and thickness of concrete member the following equation shall be fulfilled:

$$A_{i,req} < A_{i,eff}$$

Table 2: Required area  $A_{i,req}$

HIT-Z / HIT-Z-R		M8	M10	M12	M16	M20
Cracked concrete	[mm <sup>2</sup> ]	19200	40800	58800	94700	148000
Uncracked concrete	[mm <sup>2</sup> ]	22200	57400	80800	128000	198000

Table 3: Effective area  $A_{i,eff}$

Member thickness $h > h_{nom} + 1,5 \cdot c$		
Single anchor and group of anchors with $s > 3 \cdot c$	[mm <sup>2</sup> ]	$A_{i,eff} = (6 \cdot c) \cdot (h_{nom} + 1,5 \cdot c)$ with $c \geq 5 \cdot d$
Group of anchors with $s \leq 3 \cdot c$	[mm <sup>2</sup> ]	$A_{i,eff} = (3 \cdot c + s) \cdot (h_{nom} + 1,5 \cdot c)$ with $c \geq 5 \cdot d$ and $s \geq 5 \cdot d$
Member thickness $h \leq h_{nom} + 1,5 \cdot c$		
Single anchor and group of anchors with $s > 3 \cdot c$	[mm <sup>2</sup> ]	$A_{i,eff} = (6 \cdot c) \cdot h$ with $c \geq 5 \cdot d$
Group of anchors with $s \leq 3 \cdot c$	[mm <sup>2</sup> ]	$A_{i,eff} = (3 \cdot c + s) \cdot h$ with $c \geq 5 \cdot d$ and $s \geq 5 \cdot d$

$c_{min}$  and  $s_{min}$  in 5 mm steps

### Injection system Hilti HIT-HY 200-R with HIT-Z / HIT-Z-R

Minimum thickness of concrete member, minimum spacing and minimum edge distance of anchors

Annex 3

**Table 4: Materials**

Designation	Material
<b>Metal parts made of zinc coated steel</b>	
Anchor rod HIT-Z, M8 to M20	Cold formed steel, steel galvanised $\geq 5\mu\text{m}$ DIN EN ISO 4042, coated For $\leq$ M12: $R_m = 650 \text{ N/mm}^2$ ; $R_{p0.2} = 520 \text{ N/mm}^2$ , $A_5 > 8\%$ Ductile For M16: $R_m = 610 \text{ N/mm}^2$ ; $R_{p0.2} = 490 \text{ N/mm}^2$ , $A_5 > 8\%$ Ductile For M20: $R_m = 595 \text{ N/mm}^2$ ; $R_{p0.2} = 480 \text{ N/mm}^2$ , $A_5 > 8\%$ Ductile
Nut EN 24032	Strength class 8, EN 20898-2, steel galvanised $\geq 5\mu\text{m}$ DIN EN ISO 4042
Washer DIN 125	Strength class 8, steel galvanised $\geq 5\mu\text{m}$ DIN EN ISO 4042
<b>Metal parts made of stainless steel Grade A4</b>	
Anchor rod HIT-Z-R, M8 to M20	Cold formed steel; 1.4404, 1.4401 EN 10088, coated For $\leq$ M12: $R_m = 650 \text{ N/mm}^2$ ; $R_{p0.2} = 520 \text{ N/mm}^2$ , $A_5 > 8\%$ Ductile For M16: $R_m = 610 \text{ N/mm}^2$ ; $R_{p0.2} = 490 \text{ N/mm}^2$ , $A_5 > 8\%$ Ductile For M20: $R_m = 595 \text{ N/mm}^2$ ; $R_{p0.2} = 480 \text{ N/mm}^2$ , $A_5 > 8\%$ Ductile
Nut EN 24032	1.4404, 1.4401, EN 10088, A4-70 DIN ISO 3506
Washer DIN 125	A4; EN 10088



Injection system Hilti HIT-HY 200-R with HIT-Z / HIT-Z-R

Materials

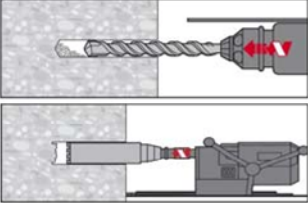
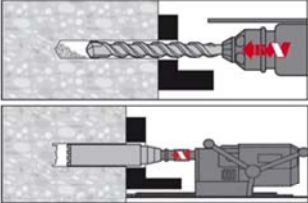
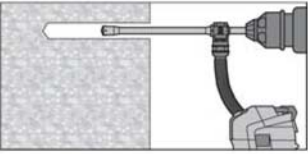
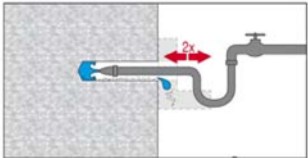
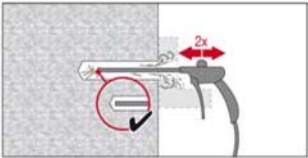
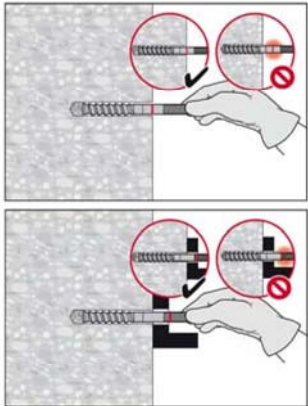
Annex 4

<b>Instruction for use</b>	
<b>Drilling</b>	
	<p><b>Pre-setting:</b> Drill hole to the required drill depth with a hammer drill set in rotation-hammer mode using an appropriately sized carbide drill bit. Diamond coring is permissible when diamond core drilling machine and the corresponding core bit are used.</p>
	<p><b>Through-setting:</b> Drill hole through the clearance hole in the fixture to the required drill depth with a hammer drill set in rotation-hammer mode using an appropriately sized carbide drill bit. Diamond coring is permissible when diamond core drilling machine and the corresponding core bit are used.</p>
	<p><b>Pre- /Through-setting:</b> Drill hole to the required embedment depth with an appropriately sized Hilti TE-CD or TE-YD hollow drill bit with Hilti vacuum attachment. This drilling removes dust while drilling (see Annex 1 – Borehole condition ②). After drilling is complete, proceed to the “injection preparation” step in the instructions for use.</p>
<b>Bore hole cleaning:</b>	
a) No cleaning required for hammer drilled boreholes	
b) Hole flushing and evacuation for wet-drilled diamond cored holes	
	<p>Flush 2 times from the back of the hole over the hole length.</p>
	<p>Blow 2 times the hole with oil-free compressed air (min. 6 bar at 6 m<sup>3</sup>/h) to evacuate the water</p>
<b>Check of setting depth and compress of the drilling dust</b>	
	<p>Mark the element, check the setting depth and compress the drilling dust. The element has to fit in the hole until the required embedment depth. If it is not possible to compress the dust, remove the dust in the drill hole or drill deeper.</p>
<b>Injection system Hilti HIT-HY 200-R with HIT-Z / HIT-Z-R</b>	
Installation instructions I	
<b>Annex 5</b>	

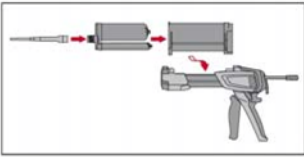
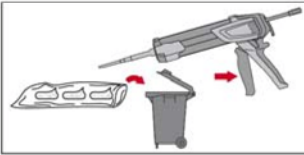
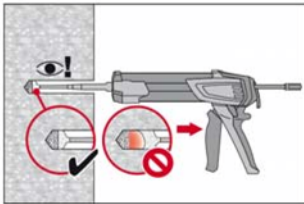

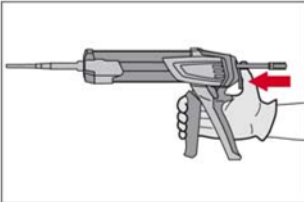
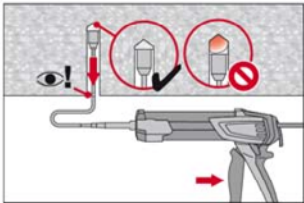
<b><u>Injection preparation</u></b>	
	Tightly attach new Hilti mixing nozzle HIT-RE-M to foil pack manifold (snug fit). Do not modify the mixing nozzle. Observe the instruction for use of the dispenser. Check foil pack holder for proper function. Do not use damaged foil packs / holders. Swing foil pack holder with foil pack into dispenser
	Discard initial adhesive. The foil pack opens automatically as dispensing is initiated. Depending on the size of the foil pack an initial amount of adhesive has to be discarded. Discard quantities are 2 strokes for 330 ml foil pack 3 strokes for 500 ml foil pack
<b><u>Inject adhesive</u></b> from the back of the borehole without forming air voids	
	Inject the adhesive starting at the back of the hole, slowly withdrawing the mixer with each trigger pull.
	Fill holes approximately 2/3 full for Pre-setting and 100% full for through-setting, or as required to ensure that the annular gap between the anchor and the concrete is completely filled with adhesive along the embedment length.
	After injection is completed, depressurize the dispenser by pressing the release trigger. This will prevent further adhesive discharge from the mixer
<b><u>Overhead installation:</u></b>	
	For overhead installation the injection is only possible with the aid of extensions and piston plugs. Assemble HIT-RE-M mixer, extension(s) and appropriately piston plug HIT-SZ. Insert piston plug to back of the hole and inject adhesive. During injection the piston plug will be naturally extruded out of the bore hole by the adhesive pressure
<b>Injection system Hilti HIT-HY 200-R with HIT-Z / HIT-Z-R</b>	
Installation instructions II	
<b>Annex 6</b>	

**Setting the element**

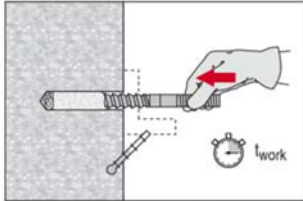

Before use, verify that the element is dry and free of oil and other contaminants. Set element to the required embedment depth until working time  $t_{work}$  (given in Table 5) has elapsed. After setting the element the annular gap between the anchor and the fixture (through-setting) or concrete (pre-setting) has to be completely filled with mortar.

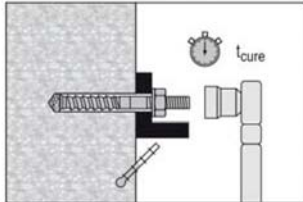

After required curing time  $t_{cure}$  (given in Table 5) remove excess mortar. The required installation torque moment is given in Table 1. The anchor can be loaded.

**Table 5: Working time  $t_{work}$  and minimum curing time  $t_{cure}$**

Temperature in the anchorage base	working time $t_{work}$	min. curing time $t_{cure}$
	HY200 -R	HY200 -R
5 °C	1 hour	3 hour
6 °C to 10 °C	40 min	2 hour
11 °C to 20 °C	15 min	1 hour
21 °C to 30 °C	9 min	1 hour
31 °C to 40 °C	6 min	1 hour

**Injection system Hilti HIT-HY 200-R with HIT-Z / HIT-Z-R**

Installation instructions III  
Working time, curing time

**Annex 7**



**Table 6: Design method A**  
**Characteristic values under tension loads**

HIT-HY 200-R with HIT-Z-...			M8	M10	M12	M16	M20
<b>Steel failure</b>							
Characteristic resistance for HIT-Z	$N_{Rk,s}$	[kN]	24	38	55	96	146
Partial safety factor <sup>1)</sup>	$\gamma_{Ms}$	[-]	1,5				
Characteristic resistance for HIT-Z-R	$N_{Rk,s}$	[kN]	24	38	55	96	146
Partial safety factor <sup>1)</sup>	$\gamma_{Ms}$	[-]	1,5				
<b>Combined pull-out and concrete cone failure</b>							
Diameter of HIT-Z / HIT-Z-R	d	[mm]	8	10	12	16	20
Characteristic bond resistance in non-cracked concrete C20/25							
Temperature range I: 24°C/40°C	$\tau_{Rk,ucr}$	[N/mm <sup>2</sup> ]	24				
Temperature range II: 50°C / 80°C	$\tau_{Rk,ucr}$	[N/mm <sup>2</sup> ]	22				
Temperature range III: 72°C / 120°C	$\tau_{Rk,ucr}$	[N/mm <sup>2</sup> ]	20				
Characteristic bond resistance in cracked concrete C20/25							
Temperature range I: 24°C/40°C	$\tau_{Rk,cr}$	[N/mm <sup>2</sup> ]	22				
Temperature range II: 50°C / 80°C	$\tau_{Rk,cr}$	[N/mm <sup>2</sup> ]	20				
Temperature range III: 72°C / 120°C	$\tau_{Rk,cr}$	[N/mm <sup>2</sup> ]	18				
Increasing factor for $\tau_{Rk,p}$	$\Psi_c$	C50/60	1,0				
Effective anchorage depth for calculation of $N_{Rk,p}^0$ (TR 029, 5.2.2.3)	$h_{ef} = l_{Helix}$	[mm]	50	60	60	96	100
<b>Concrete cone failure</b>							
For calculation of the characteristic resistance $N_{Rk,c}$ according to TR 029 section 5.2.2.4 the embedment depth $h_{ef}$ shall be replaced by $h_{nom}$ according annex 1.							
<b>Splitting failure</b>							
Edge distance $c_{cr,sp}$ [mm]	$h / h_{nom}^{3)} \geq 2,35$		1,5 $h_{nom}$				
	$2,35 > h / h_{nom}^{3)} > 1,35$		6,2 $h_{nom} - 2,0 h$				
	$h / h_{nom}^{3)} \leq 1,35$		3,5 $h_{nom}$				
Spacing	$s_{cr,sp}$	[mm]	2 $c_{cr,sp}$				
Partial safety factor <sup>1)</sup>	$\gamma_{Mp} = \gamma_{Mc} = \gamma_{Msp}$	[-]	1,5 <sup>2)</sup>				

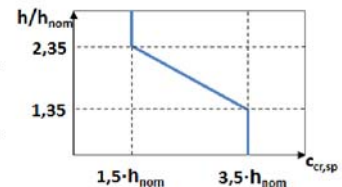

<sup>1)</sup> In absence of other national regulations.

<sup>2)</sup> The partial safety factor  $\gamma_2 = 1.0$  is included.

<sup>3)</sup>  $h$  = material thickness;  $h_{nom}$  = embedment depth.

**Injection system Hilti HIT-HY 200-R with HIT-Z / HIT-Z-R**

Design method A  
Characteristic values of resistance under tension loads

**Annex 8**

Table 7: Displacements under tension loads <sup>1)</sup>

HIT-HY 200-R with HIT-Z-...			M8	M10	M12	M16	M20
<b>Non-cracked concrete temperature range I <sup>2)</sup>: 40 °C / 24 °C</b>							
Displacement	$\delta_{N0}$	[mm/(N/mm <sup>2</sup> )]	0,03	0,03	0,04	0,05	0,07
Displacement	$\delta_{N\infty}$	[mm/(N/mm <sup>2</sup> )]	0,06	0,08	0,10	0,13	0,17
<b>Non-cracked concrete temperature range II <sup>2)</sup>: 80 °C / 50 °C</b>							
Displacement	$\delta_{N0}$	[mm/(N/mm <sup>2</sup> )]	0,03	0,04	0,04	0,06	0,07
Displacement	$\delta_{N\infty}$	[mm/(N/mm <sup>2</sup> )]	0,07	0,09	0,11	0,15	0,18
<b>Non-cracked concrete temperature range III <sup>2)</sup>: 120 °C / 72 °C</b>							
Displacement	$\delta_{N0}$	[mm/(N/mm <sup>2</sup> )]	0,03	0,04	0,05	0,06	0,08
Displacement	$\delta_{N\infty}$	[mm/(N/mm <sup>2</sup> )]	0,07	0,10	0,12	0,16	0,20
<b>Cracked concrete temperature range I <sup>2)</sup>: 40 °C / 24 °C</b>							
Displacement	$\delta_{N0}$	[mm/(N/mm <sup>2</sup> )]	0,06	0,07	0,08	0,09	0,10
Displacement	$\delta_{N\infty}$	[mm/(N/mm <sup>2</sup> )]	0,21				
<b>Cracked concrete temperature range II <sup>2)</sup>: 80 °C / 50 °C</b>							
Displacement	$\delta_{N0}$	[mm/(N/mm <sup>2</sup> )]	0,07	0,08	0,08	0,10	0,11
Displacement	$\delta_{N\infty}$	[mm/(N/mm <sup>2</sup> )]	0,23				
<b>Cracked concrete temperature range III <sup>2)</sup>: 120 °C / 72 °C</b>							
Displacement	$\delta_{N0}$	[mm/(N/mm <sup>2</sup> )]	0,07	0,08	0,09	0,11	0,12
Displacement	$\delta_{N\infty}$	[mm/(N/mm <sup>2</sup> )]	0,25				

<sup>1)</sup> Calculation of displacement under service load:  $\tau_{Sd}$  design value of bond stress

Displacement under short term loading =  $\delta_{N0} \cdot \tau_{Sd} / 1,4$ ;

Displacement under long term loading =  $\delta_{N\infty} \cdot \tau_{Sd} / 1,4$

<sup>2)</sup> Explanation see chapter 1.2

Injection system Hilti HIT-HY 200-R with HIT-Z / HIT-Z-R

Displacements under tension loads

Annex 9

**Table 8: Design method A**  
**Characteristic values of resistance under shear loads**

HIT-HY 200-R with HIT-Z-...		M8	M10	M12	M16	M20
<b>Steel failure without lever arm</b>						
Characteristic resistance for HIT-Z	$V_{Rk,s}$ [kN]	12	19	27	48	73
Partial safety factor <sup>1)</sup>	$\gamma_{Ms}$ [-]	1,25				
Characteristic resistance for HIT-Z-R	$V_{Rk,s}$ [kN]	14	23	33	57	88
Partial safety factor <sup>1)</sup>	$\gamma_{Ms}$ [-]	1,25				
<b>Steel failure with lever arm</b>						
Characteristic resistance for HIT-Z	$M^0_{Rk,s}$ [Nm]	24	49	85	203	386
Partial safety factor <sup>1)</sup>	$\gamma_{Ms}$ [-]	1,25				
Characteristic resistance for HIT-Z-R	$M^0_{Rk,s}$ [Nm]	24	49	85	203	386
Partial safety factor <sup>1)</sup>	$\gamma_{Ms}$ [-]	1,25				
<b>Concrete pryout failure</b>						
Factor for calculation of $V_{Rk,pc}$ (TR 029, 5.2.3.3)	k [-]	2,0				
Partial safety factor <sup>1)</sup>	$\gamma_{Mcp}$ [-]	1,5 <sup>2)</sup>				
<b>Concrete edge failure</b>						
Effective length of anchor in shear loading	$l_f$ [mm]	$h_{nom}$	$h_{nom}$	$h_{nom}$	$h_{nom}$	$h_{nom}$
Diameter of anchor	$d_{nom}$ [mm]	8	10	12	16	20
Partial safety factor <sup>1)</sup>	$\gamma_{Mc}$ [-]	1,5 <sup>2)</sup>				

<sup>1)</sup> In absence of other national regulations.

<sup>2)</sup> The partial safety factor  $\gamma_2 = 1.0$  is included.

**Table 9: Displacements under shear loads <sup>1)</sup>**

HIT-HY 200-R with HIT-Z-...		M8	M10	M12	M16	M20
Displacement	$\delta_{V0}$ [mm]	0,06	0,06	0,05	0,04	0,04
Displacement	$\delta_{V\infty}$ [mm]	0,09	0,08	0,08	0,06	0,06

<sup>1)</sup> Calculation of displacement under service load:  $V_{sd}$  design value of shear stress

Displacement under short term loading =  $\delta_{V0} \cdot V_d / 1,4$ ;

Displacement under long term loading =  $\delta_{V\infty} \cdot V_d / 1,4$

**Injection system Hilti HIT-HY 200-R with HIT-Z / HIT-Z-R**

Design method A  
Characteristic values of resistance under shear loads

**Annex 10**