



European Technical Approval ETA-12/0084

English translation prepared by DIBt - Original version in German language

Handelsbezeichnung <i>Trade name</i>	Injektionssystem Hilti HIT-HY 200-R <i>Injection system Hilti HIT-HY 200-R</i>
Zulassungsinhaber <i>Holder of approval</i>	Hilti AG Feldkircherstraße 100 9494 Schaan FÜRSTENTUM LIECHTENSTEIN
Zulassungsgegenstand und Verwendungszweck <i>Generic type and use of construction product</i>	Verbunddübel mit Gewindestangen, Betonstahl, Innengewindehülsen und Hilti Zuganker HZA zur Verankerung im Beton <i>Bonded anchor with threaded rods, rebar, internal threaded sleeves and Hilti tension anchor HZA for use in concrete</i>
Geltungsdauer: <i>Validity:</i>	vom <i>from</i> bis <i>to</i> 6 February 2012 6 February 2017
Herstellwerk <i>Manufacturing plant</i>	Hilti Werke

Diese Zulassung umfasst
This Approval contains

32 Seiten einschließlich 23 Anhänge
32 pages including 23 annexes

I LEGAL BASES AND GENERAL CONDITIONS

- 1 This European technical approval is issued by Deutsches Institut für Bautechnik in accordance with:
 - Council Directive 89/106/EEC of 21 December 1988 on the approximation of laws, regulations and administrative provisions of Member States relating to construction products¹, modified by Council Directive 93/68/EEC² and Regulation (EC) N° 1882/2003 of the European Parliament and of the Council³;
 - *Gesetz über das In-Verkehr-Bringen von und den freien Warenverkehr mit Bauprodukten zur Umsetzung der Richtlinie 89/106/EWG des Rates vom 21. Dezember 1988 zur Angleichung der Rechts- und Verwaltungsvorschriften der Mitgliedstaaten über Bauprodukte und anderer Rechtsakte der Europäischen Gemeinschaften (Bauproduktengesetz - BauPG) vom 28. April 1998⁴, as amended by law of 31 October 2006⁵;*
 - Common Procedural Rules for Requesting, Preparing and the Granting of European technical approvals set out in the Annex to Commission Decision 94/23/EC⁶;
 - Guideline for European technical approval of "Metal anchors for use in concrete - Part 5: Bonded anchors", ETAG 001-05.
- 2 Deutsches Institut für Bautechnik is authorized to check whether the provisions of this European technical approval are met. Checking may take place in the manufacturing plant. Nevertheless, the responsibility for the conformity of the products to the European technical approval and for their fitness for the intended use remains with the holder of the European technical approval.
- 3 This European technical approval is not to be transferred to manufacturers or agents of manufacturers other than those indicated on page 1, or manufacturing plants other than those indicated on page 1 of this European technical approval.
- 4 This European technical approval may be withdrawn by Deutsches Institut für Bautechnik, in particular pursuant to information by the Commission according to Article 5(1) of Council Directive 89/106/EEC.
- 5 Reproduction of this European technical approval including transmission by electronic means shall be in full. However, partial reproduction can be made with the written consent of Deutsches Institut für Bautechnik. In this case partial reproduction has to be designated as such. Texts and drawings of advertising brochures shall not contradict or misuse the European technical approval.
- 6 The European technical approval is issued by the approval body in its official language. This version corresponds fully to the version circulated within EOTA. Translations into other languages have to be designated as such.

¹ Official Journal of the European Communities L 40, 11 February 1989, p. 12
² Official Journal of the European Communities L 220, 30 August 1993, p. 1
³ Official Journal of the European Union L 284, 31 October 2003, p. 25
⁴ *Bundesgesetzblatt Teil I 1998*, p. 812
⁵ *Bundesgesetzblatt Teil I 2006*, p. 2407, 2416
⁶ Official Journal of the European Communities L 17, 20 January 1994, p. 34

II SPECIFIC CONDITIONS OF THE EUROPEAN TECHNICAL APPROVAL

1 Definition of product and intended use

1.1 Definition of the construction product

The Injection System Hilti HIT-HY 200-R is a bonded anchor consisting of injection mortar Hilti HIT-HY 200-R and a steel element.

The injection mortar Hilti HIT-HY 200-R is delivered in foil packs acc. to Annex 1.

The steel elements are made of zinc coated steel (threaded rod HIT-V, internal sleeve HIS-N, tension anchor HZA), reinforcing bar, stainless steel (threaded rod HIT-V-R, internal sleeve HIS-RN or tension anchor HZA-R) or high corrosion resistant steel (threaded rods HIT-V-HCR or tension anchor HZA-HCR).

The steel element is placed into a drilled hole filled with injection mortar and is anchored via the bond between metal part, injection mortar and concrete.

An illustration of the product and intended use is given in Annexes 1 and 2.

1.2 Intended use

The anchor is intended to be used for anchorages for which requirements for mechanical resistance and stability and safety in use in the sense of the Essential Requirements 1 and 4 of Council Directive 89/106 EEC shall be fulfilled and failure of anchorages made with these products would cause risk to human life and/or lead to considerable economic consequences. Safety in case of fire (Essential Requirement 2) is not covered in this European technical approval. The anchor is to be used only for anchorages subject to static or quasi-static loading in reinforced or unreinforced normal weight concrete of strength classes C20/25 at minimum and C50/60 at most according to EN 206:2000-12.

The anchor may be used in cracked and non-cracked concrete.

The anchor may be installed in dry or wet concrete; it must not be installed in flooded holes.

The anchor may be used in the following temperature ranges:

- Temperature range I: -40 °C to +40 °C (max long term temperature +24 °C and max short term temperature +40 °C)
- Temperature range II: -40 °C to +80 °C (max long term temperature +50 °C and max short term temperature +80 °C)
- Temperature range III: -40 °C to +120 °C (max long term temperature +72 °C and max short term temperature +120 °C)

Elements made of zinc coated steel (threaded rods HIT-V, internal sleeve HIS-N, tension anchor HZA):

The element made of electroplated or hot-dipped galvanised steel may only be used in structures subject to dry internal conditions.

Elements made of stainless steel (threaded rods HIT-V-R, internal sleeve HIS-RN, tension anchor HZA-R):

The element made of stainless steel 1.4401, 1.4404, 1.4578, 1.4571, 1.4439 or 1.4362 may be used in structures subject to dry internal conditions and also in structures subject to external atmospheric exposure (including industrial and marine environment), or exposure to permanently damp internal conditions, if no particular aggressive conditions exist. Such particular aggressive conditions are e.g. permanent, alternating immersion in seawater or the splash zone of seawater, chloride atmosphere of indoor swimming pools or atmosphere with extreme chemical pollution (e.g. in desulphurization plants or road tunnels where de-icing materials are used).

Elements made of high corrosion resistant steel (threaded rods HIT-V-HCR, tension Anchor HZA-HCR):

The element made of high corrosion resistant steel 1.4529 or 1.4565 may be used in structures subject to dry internal conditions and also in structures subject to external atmospheric exposure, in permanently damp internal conditions or in other particular aggressive conditions. Such particular aggressive conditions are e. g. permanent, alternating immersion in seawater or the splash zone of seawater, chloride atmosphere of indoor swimming pools or atmosphere with chemical pollution (e.g. in desulphurization plants or road tunnels where de-icing materials are used).

Elements made of reinforcing bars:

Post-installed reinforcing bars may be used as anchor designed in accordance with the EOTA Technical Report TR 029 only. Such applications are e.g. concrete overlay or shear dowel connections or the connections of a wall predominantly loaded by shear and compression forces with the foundation, where the reinforcing bars act as dowels to take up shear forces. Connections with post-installed reinforcing bars in concrete structures designed in accordance with EN 1992-1-1:2004 are not covered by this European technical approval.

The provisions made in this European technical approval are based on an assumed working life of the anchor of 50 years. The indications given on the working life cannot be interpreted as a guarantee given by the producer, but are to be regarded only as a means for choosing the right products in relation to the expected economically reasonable working life of the works.

2 Characteristics of the product and methods of verification

2.1 Characteristics of the product

The anchor corresponds to the drawings and provisions given in Annexes 3 to 7. The characteristic material values, dimensions and tolerances of the anchor not indicated in Annexes 3 to 7 shall correspond to the respective values laid down in the technical documentation⁷ of this European technical approval.

The characteristic values for the design of anchorages are given in Annexes 12 to 23.

The two components of the injection mortar Hilti HIT-HY 200-R are delivered in unmixed condition in foil packs of sizes 330 ml or 500 ml according to Annex 1. Each foil pack is marked with the identifying mark "HY 200-R", with the batch number and expiry date.

⁷ The technical documentation of this European technical approval is deposited at the Deutsches Institut für Bautechnik and, as far as relevant for the tasks of the approved bodies involved in the attestation of conformity procedure, is handed over to the approved bodies.

Each threaded rod HIT-V is marked with the marking of steel grade and length in accordance with Annex 3. Each threaded rod made of stainless steel is marked with the additional letter "R". Each threaded rod made of high corrosion resistant steel is marked with the additional letter "HCR".

Each internal sleeve made of zinc coated steel is marked with "Hilti HIS-N" according to Annex 4. Each internal sleeve made of stainless steel is marked with "Hilti HIS-RN" according to Annex 4.

Each Tension anchor made of stainless steel is marked with "HZA-R", the thread size and maximum thickness of fixture according to Annex 6. Each Tension anchor made of high corrosion resistance steel is marked with "HZA-HCR", the thread size and maximum thickness of fixture according to Annex 6.

Elements made of reinforcing bar shall comply with the specifications given in Annex 5.

The marking of embedment depth may be done on jobsite.

2.2 Methods of verification

The assessment of fitness of the anchor for the intended use in relation to the requirements for mechanical resistance and stability and safety in use in the sense of the Essential Requirements 1 and 4 has been made in accordance with the "Guideline for European technical approval of Metal Anchors for use in concrete", Part 1 "Anchors in general" and Part 5 "Bonded anchors", on the basis of Option 1.

In addition to the specific clauses relating to dangerous substances contained in this European technical approval, there may be other requirements applicable to the products falling within its scope (e.g. transposed European legislation and national laws, regulations and administrative provisions). In order to meet the provisions of the Construction Products Directive, these requirements need also to be complied with, when and where they apply.

3 Evaluation and attestation of conformity and CE marking

3.1 System of attestation of conformity

According to the Decision 96/582/EG of the European Commission⁸ system 2(i) (referred to as System 1) of the attestation of conformity applies.

This system of attestation of conformity is defined as follows:

System 1: Certification of the conformity of the product by an approved certification body on the basis of:

- (a) Tasks for the manufacturer:
 - (1) factory production control;
 - (2) further testing of samples taken at the factory by the manufacturer in accordance with a prescribed control plan;
- (b) Tasks for the approved body:
 - (3) initial type-testing of the product;
 - (4) initial inspection of factory and of factory production control;
 - (5) continuous surveillance, assessment and approval of factory production control.

Note: Approved bodies are also referred to as "notified bodies".

⁸ Official Journal of the European Communities L 254 of 08.10.1996

3.2 Responsibilities

3.2.1 Tasks for the manufacturer

3.2.1.1 Factory production control

The manufacturer shall exercise permanent internal control of production. All the elements, requirements and provisions adopted by the manufacturer shall be documented in a systematic manner in the form of written policies and procedures, including records of results performed. This production control system shall insure that the product is in conformity with this European technical approval.

The manufacturer may only use initial/raw/constituent materials stated in the technical documentation of this European technical approval.

The factory production control shall be in accordance with the control plan which is part of the technical documentation of this European technical approval. The control plan is laid down in the context of the factory production control system operated by the manufacturer and deposited at Deutsches Institut für Bautechnik.⁹

The results of factory production control shall be recorded and evaluated in accordance with the provisions of the control plan.

3.2.1.2 Other tasks for the manufacturer

The manufacturer shall, on the basis of a contract, involve a body which is approved for the tasks referred to in section 3.1 in the field of anchors in order to undertake the actions laid down in section 3.2.2 For this purpose, the control plan referred to in sections 3.2.1.1 and 3.2.2 shall be handed over by the manufacturer to the approved body involved.

The manufacturer shall make a declaration of conformity, stating that the construction product is in conformity with the provisions of this European technical approval.

3.2.2 Tasks for the approved bodies

The approved body shall perform the

- initial type-testing of the product,
- initial inspection of factory and of factory production control,
- continuous surveillance, assessment and approval of factory production control,

in accordance with the provisions laid down in the control plan.

The approved body shall retain the essential points of its actions referred to above and state the results obtained and conclusions drawn in a written report.

The approved certification body involved by the manufacturer shall issue an EC certificate of conformity of the product stating the conformity with the provisions of this European technical approval.

In cases where the provisions of the European technical approval and its control plan are no longer fulfilled the certification body shall withdraw the certificate of conformity and inform Deutsches Institut für Bautechnik without delay.

3.3 CE marking

The CE marking shall be affixed on each packaging of the anchor. The letters "CE" shall be followed by the identification number of the approved certification body, where relevant, and be accompanied by the following additional information:

- the name and address of the producer (legal entity responsible for the manufacture),
- the last two digits of the year in which the CE marking was affixed,

⁹ The control plan is a confidential part of the European technical approval and only handed over to the approved body involved in the procedure of attestation of conformity. See section 3.2.2.

- the number of the EC certificate of conformity for the product,
- the number of the European technical approval,
- the number of the guideline for European technical approval,
- use category (ETAG 001-1, Option 1),
- size.

4 Assumptions under which the fitness of the product for the intended use was favourably assessed

4.1 Manufacturing

The European technical approval is issued for the product on the basis of agreed data/information, deposited at Deutsches Institut für Bautechnik, which identifies the product that has been assessed and judged. Changes to the product or production process, which could result in this deposited data/information being incorrect, should be notified to Deutsches Institut für Bautechnik before the changes are introduced. Deutsches Institut für Bautechnik will decide whether or not such changes affect the approval and consequently the validity of the CE marking on the basis of the approval and if so whether further assessment or alterations to the approval shall be necessary.

4.2 Design of anchorages

The fitness of the anchor for the intended use is given under the following conditions:

The anchorages are designed in accordance with the EOTA Technical Report TR 029 "Design of bonded anchors"¹⁰ under the responsibility of an engineer experienced in anchorages and concrete work.

Post-installed reinforcing bars may be used as anchor designed in accordance with the EOTA Technical Report TR 029 only. The basic assumptions for the design according to anchor theory shall be observed. This includes the consideration of tension and shear loads and the corresponding failure modes as well as the assumption that the base material (concrete structural element) remains essentially in the serviceability limit state (either non-cracked or cracked) when the connection is loaded to failure. Such applications are e.g. concrete overlay or shear dowel connections or the connections of a wall predominantly loaded by shear and compression forces with the foundation, where the reinforcing bars act as dowels to take up shear forces. Connections with reinforcing bars in concrete structures designed in accordance with EN1992-1-1:2004 (e.g. connection of a wall loaded with tension forces in one layer of the reinforcement with the foundation) are not covered by this European technical approval.

Material and required strength class of the fastening screws or threaded rods shall be specified in accordance with Annex 7.

The minimum and maximum thread engagement length h_s of the fastening screw or the threaded rod for installation of the fixture shall meet the requirements according to Annex 4, Table 2. The length of the fastening screw or the threaded rod shall be determined depending on thickness of fixture, admissible tolerances, available thread length and minimum and maximum thread engagement length h_s .

Verifiable calculation notes and drawings are prepared taking account of the loads to be anchored.

The position of the anchor is indicated on the design drawings (e.g. position of the anchor relative to reinforcement or to supports, etc.).

¹⁰ The Technical Report TR 029 "Design of bonded anchors" is published in English on EOTA website www.eota.eu.

4.3 Installation of anchors

The fitness for use of the anchor can only be assumed if the anchor is installed as follows:

- anchor installation carried out by appropriately qualified personnel and under the supervision of the person responsible for technical matters of the site,
- anchor installation in accordance with the manufacturer's specifications and drawings using the tools indicated in the technical documentation of this European technical approval,
- use of the anchor only as supplied by the manufacturer without exchanging the components of an anchor,
- commercial standard threaded rods, washers and hexagon nuts may also be used if the following requirements are fulfilled:
 - material, dimensions and mechanical properties of the metal parts according to the specifications given in Annex 7, Table 5,
 - confirmation of material and mechanical properties of the metal parts by inspection certificate 3.1 according to EN 10204:2004, the documents should be stored,
 - marking of the threaded rod with the envisage embedment depth. This may be done by the manufacturer of the rod or the person on jobsite.
- checks before placing the anchor to ensure that the strength class of the concrete in which the anchor is to be placed is in the range given and is not lower than that of the concrete to which the characteristic loads apply,
- check of concrete being well compacted, e.g. without significant voids,
- marking and keeping the effective anchorage depth,
- edge distance and spacing not less than the specified values without minus tolerances,
- positioning of the drill holes without damaging the reinforcement,
- drilling by hammer-drilling only,
- in case of aborted drill hole: the drill hole shall be filled with mortar,
- the anchor must not be installed in flooded holes,
- keeping the installation instructions given in Annexes 8 to 11,
- the installation temperature of the mortar shall be at least +5 °C; during curing of the chemical mortar the temperature of the concrete must not fall below -10 °C; observing the curing time according to Annex 12, Table 7 until the anchor may be loaded,
- fastening screws or threaded rods (including nut and washer) for the internal sleeves HIS-(R)N must be made of appropriate steel grade and property class,
- installation torque moments are not required for functioning of the anchor. However, the torque moments given in Annexes 3, 4 and 6 must not be exceeded.

5 Recommendations concerning packaging, transport and storage

5.1 Responsibility of the manufacturer

The manufacturer is responsible to ensure that the information on the specific conditions according to 1 and 2 including Annexes referred to as well as sections 4.2 and 4.3 is given to those who are concerned. This information may be made by reproduction of the respective parts of the European technical approval.

In addition all installation data shall be shown clearly on the package and/or on an enclosed instruction sheet, preferably using illustration(s).

The minimum data required are:

- drill bit diameter,
- hole depth,
- diameter of anchor rod,
- minimum effective anchorage depth,
- information on the installation procedure, including cleaning of the hole with the cleaning equipments, preferably by means of an illustration,
- anchor component installation temperature,
- ambient temperature of the concrete during installation of the anchor,
- admissible processing time (open time) of the mortar,
- curing time until the anchor may be loaded as a function of the ambient temperature in the concrete during installation,
- maximum torque moment,
- identification of the manufacturing batch,

All data shall be presented in a clear and explicit form.

5.2 Packaging, transport and storage

The foil packs shall be protected against sun radiation and shall be stored according to the manufacturer's installation instructions in dry condition at temperatures of at least +5 °C to not more than +25 °C.

Foil packs with expired shelf life must no longer be used.

The anchor shall only be packaged and supplied as a complete unit. Foil packs may be packed separately from metal parts.

Georg Feistel
Head of Department

beglaubigt:
G. Lange

Injection mortar Hilti HIT-HY 200-R:
hybrid system with resin, hardener and cement water component

Foil pack 330 ml and 500 ml

Marking
HY 200-R
Batch number
Expiry date



Static Mixer HILTI HIT-RE-M

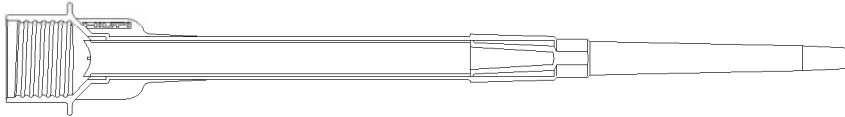

Steel elements:

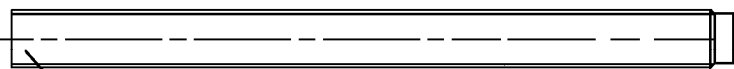

Threaded rod HIT-V-...
thread sizes M8, M10, M12, M16, M20, M24, M27 or M30

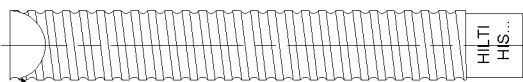
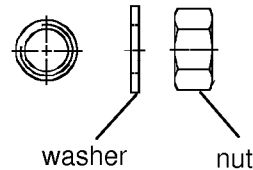

Internal sleeve HIS-(R)N...
thread sizes M8, M10, M12, M16 or M20

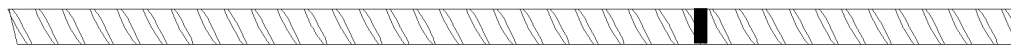

Deformed carbon steel bars for concrete reinforcement (rebar)
Ø8, Ø10, Ø12, Ø14, Ø16, Ø20, Ø25, Ø26, Ø28, Ø30 or Ø32

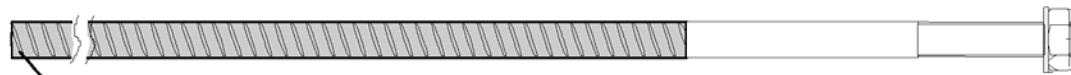

Hilti Tension anchor HZA-R M12, M16, M20 or M24
Hilti Tension anchor HZA-HCR M12, M16 or M20
Hilti Tension anchor HZA M12, M16, M20; M24 or M27

Injection system Hilti HIT-HY 200-R

Annex 1

Product

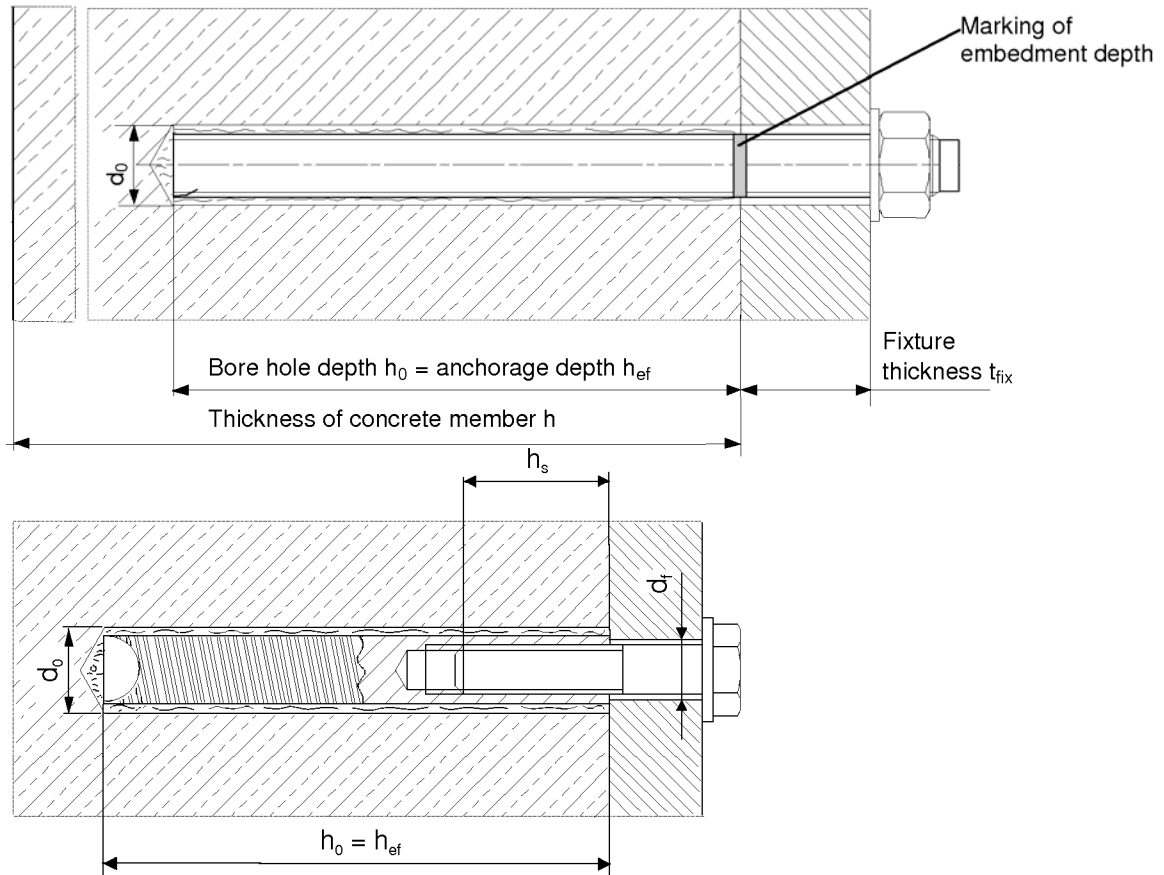

Use category: Installation in dry or water saturated concrete, (not in flooded holes)

Temperature range I:	-40 °C to +40 °C	(max long term temperature +24 °C and max short term temperature +40 °C)
Temperature range II:	-40 °C to +80 °C	(max long term temperature +50 °C and max short term temperature +80 °C)
Temperature range III:	-40 °C to +120 °C	(max long term temperature +72 °C and max short term temperature +120 °C)

Injection system Hilti HIT-HY 200-R

Annex 2

Installed anchor and intended use

Table 1: Installation parameters of anchor rod HIT-V-...

HIT-HY 200-R with HIT-V-...			M8	M10	M12	M16	M20	M24	M27	M30
Diameter of element	d	[mm]	8	10	12	16	20	24	27	30
Range of anchorage (h_{ef}) and drill hole depth (h_o)	min	[mm]	60	60	70	80	90	96	108	120
	max		160	200	240	320	400	480	540	600
Nominal diameter of drill bit	d_o	[mm]	10	12	14	18	22	28	30	35
Diameter of clearance hole in the fixture Pre installation ¹⁾	d_f	[mm]	9	12	14	18	22	26	30	33
Max torque moment	T_{max}	[Nm]	10	20	40	80	150	200	270	300
Minimum thickness of concrete member	h_{min}	[mm]	$h_{ef} + 30$			$h_{ef} + 2d_o$				
Minimum spacing	s_{min}	[mm]	40	50	60	80	100	120	135	150
Minimum edge distance	c_{min}	[mm]	40	50	60	80	100	120	135	150

¹⁾ For larger clearance hole in the fixture see TR029 section 1.1

HIT-V...

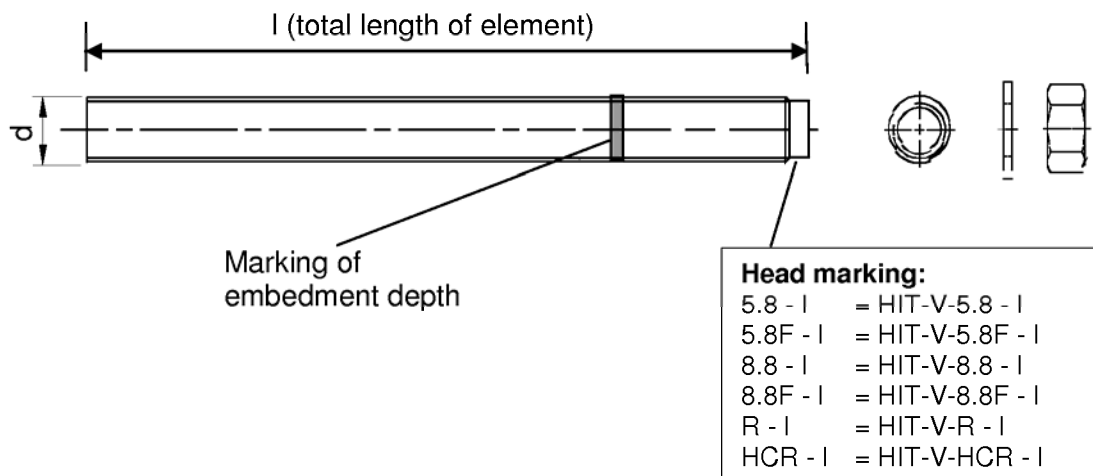

Injection system Hilti HIT-HY 200-R

Annex 3

Installation parameters
Threaded rod HIT-V-...

Table 2: Installation parameters of internal sleeve HIS-(R)N

HIT-HY 200-R with HIS-(R)N			M 8	M 10	M 12	M 16	M 20
Diameter of element	d	[mm]	12,5	16,5	20,5	25,4	27,6
Effective anchorage depth	h_{ef}	[mm]	90	110	125	170	205
Nominal diameter of drill bit	d_0	[mm]	14	18	22	28	32
Depth of drilled hole	h_0	[mm]	90	110	125	170	205
Diameter of clearance hole in the fixture	d_f	[mm]	9	12	14	18	22
Max. torque moment	T_{max}	[Nm]	10	20	40	80	150
Thread engagement length min-max	h_s	[mm]	8-20	10-25	12-30	16-40	20-50
Minimum thickness of concrete member	h_{min}	[mm]	120	150	170	230	270
Minimum spacing	s_{min}	[mm]	40	45	55	65	90
Minimum edge distance	c_{min}	[mm]	40	45	55	65	90

HIS-(R)N

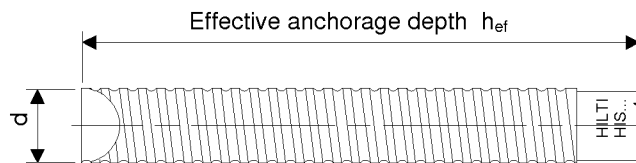

Marking:
Identifying mark - HILTI and
embossing "HIS-N" (for C-steel)
embossing "HIS-RN" (for stainless steel)

Injection system Hilti HIT-HY 200-R

Annex 4

Installation parameters
Internal sleeve HIS-(R)N

Table 3: Installation parameters of anchor element rebar

HIT-HY 200-R with rebar		Ø8	Ø10	Ø12	Ø14	Ø16	Ø20	Ø25	Ø26	Ø28	Ø30	Ø32
Diameter of element	d [mm]	8	10	12	14	16	20	25	26	28	30	32
Range of anchorage (h_{ef}) and drill hole depth (h_0)	min [mm]	60	60	70	75	80	90	100	104	112	120	128
	max [mm]	160	200	240	280	320	400	500	520	560	600	640
Nominal diameter of drill bit	d_0 [mm]	12 / 10 ¹⁾	14 / 12 ¹⁾	14 ¹⁾ / 16 ¹⁾	18	20	25	32	32	35	37	40
Minimum thickness of concrete member	h_{min} [mm]	$h_{ef} + 30$			$h_{ef} + 2d_0$							
Minimum spacing	s_{min} [mm]	40	50	60	70	80	100	125	130	140	150	160
Minimum edge distance	c_{min} [mm]	40	50	60	70	80	100	125	130	140	150	160

¹⁾ Both given values for drill bit diameter can be used

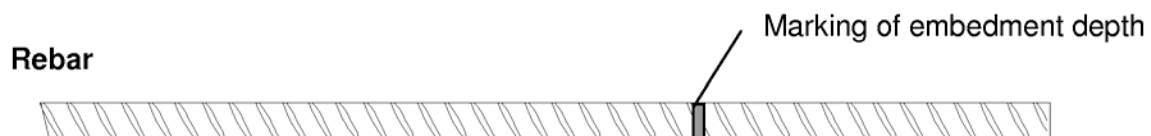

Refer to EN1992-1-1 Annex C Table C.1 and C.2N Properties of reinforcement:

Product form		Bars and de-coiled rods	
Class		B	C
Characteristic yield strength f_{yk} or $f_{0,2k}$ (MPa)		400 to 600	
Minimum value of $k = (f_t/f_y)_k$		$\geq 1,08$	$\geq 1,15$ < 1,35
Characteristic strain at maximum force, ϵ_{1uk} (%)		$\geq 5,0$	$\geq 7,5$
Bendability		Bend / Rebend test	
Maximum deviation from nominal mass (individual bar) (%)	Nominal bar size (mm) ≤ 8	$\pm 6,0$	
	> 8	$\pm 4,5$	
Bond: Minimum relative rib area, $f_{R,min}$ (determination according to EN 15630)	Nominal bar size (mm) 8 to 12	0,040	
	> 12	0,056	

Height of the rebar rib h_{rib} :

The height of the rebar rib h_{rib} shall fulfil the following requirement: $0,05 * d \leq h_{rib} \leq 0,07 * d$
with: d = nominal diameter of the rebar element

Injection system Hilti HIT-HY 200-R

Annex 5

Installation parameters
rebar

Table 4: Installation parameters of Hilti tension anchor HZA-R, HZA-HCR

HIT-HY 200-R with HZA-R, HZA-HCR			M12	M16	M20	M24 ¹⁾
Diameter of element	d	[mm]	12	16	20	25
Range of embedment (h_{nom}) and drill hole depth (h_0)	min	[mm]	170	180	190	200
	max	[mm]	240	320	400	500
Bond length	h_{ef}	[mm]	$h_{nom} - 100$			
Length of smooth shaft	l_e	[mm]	100			
Nominal diameter of drill bit	d_0	[mm]	16	20	25	32
Diameter of clearance hole in the fixture	d_f	[mm]	14	18	22	26
Max. torque moment	T_{max}	[Nm]	40	80	150	200
Minimum thickness of concrete member	h_{min}	[mm]	$h_{nom} + 2d_0$			
Minimum spacing	s_{min}	[mm]	60	80	100	120
Minimum edge distance	c_{min}	[mm]	60	80	100	120

¹⁾ Just as HZA-R available

HZA-R, HZA-HCR

Marking:
embossing "HZA-R" M .. / t_{fix}
"HZA-HCR" M .. / t_{fix}

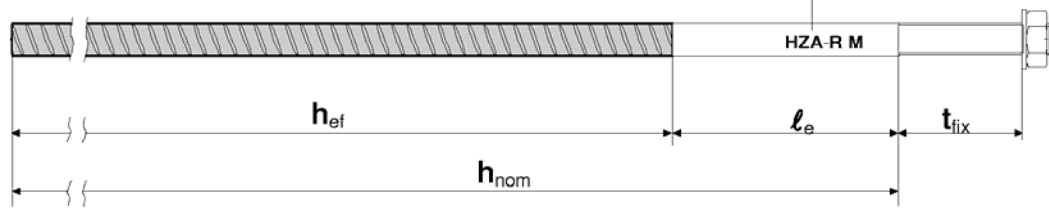

Table 5: Installation parameters of Hilti tension anchor HZA

HIT-HY 200-R with HZA			M12	M16	M20	M24	M27
Diameter of element	d	[mm]	12	16	20	25	28
Range of embedment (h_{nom}) and drill hole depth (h_0)	min	[mm]	90	100	110	120	140
	max	[mm]	240	320	400	500	560
Bond length	h_{ef}	[mm]	$h_{nom} - 20$				
Length of smooth shaft	l_e	[mm]	20				
Nominal diameter of drill bit	d_0	[mm]	16	20	25	32	35
Diameter of clearance hole in the fixture	d_f	[mm]	14	18	22	26	30
Max. torque moment	T_{max}	[Nm]	40	80	150	200	270
Minimum thickness of concrete member	h_{min}	[mm]	$h_{nom} + 2d_0$				
Minimum spacing	s_{min}	[mm]	60	80	100	120	135
Minimum edge distance	c_{min}	[mm]	60	80	100	120	135

Injection system Hilti HIT-HY 200-R

Annex 6

Installation parameters
HZA, HZA-R, HZA-HCR

Table 6: Materials

Designation	Material
Metal parts made of rebar	
Rebar	See Annex 5
Metal parts made of zinc coated steel	
Threaded rod HIT-V-5.8(F)	Strength class 5.8 , $R_m = 500 \text{ N/mm}^2$; $R_{p0,2} = 400 \text{ N/mm}^2$, $A_5 > 8\%$ Ductile Steel galvanized $\geq 5\mu\text{m}$ EN ISO 4042 (F) hot dipped galvanized $\geq 45\mu\text{m}$ EN ISO 10684
Threaded rod HIT-V-8.8(F)	Strength class 8.8 , $R_m = 800 \text{ N/mm}^2$; $R_{p0,2} = 640 \text{ N/mm}^2$, $A_5 > 8\%$ Ductile Steel galvanized $\geq 5\mu\text{m}$ EN ISO 4042 (F) hot dipped galvanized $\geq 45\mu\text{m}$ EN ISO 10684
Hilti tension anchor HZA	Round steel smooth with thread, steel galvanized A2K EN ISO 4042 Rebar B500-B acc. DIN 488-1:2009 and DIN 488-2:2009
Washer ISO 7089	Steel galvanized EN ISO 4042; hot dipped galvanized EN ISO 10684
Nut EN ISO 4032	Strength class 8 ISO 898-2 Steel galvanized $\geq 5\mu\text{m}$ EN ISO 4042; hot dipped galvanized $\geq 45\mu\text{m}$ EN ISO 10684
Internally threaded Sleeves ¹⁾ HIS-N	Carbon steel 1.0718, EN 10277-3 Steel galvanized $\geq 5\mu\text{m}$ EN ISO 4042
Metal parts made of stainless steel	
Threaded rod HIT-V-R	For $\leq \text{M}24$: strength class 70 , $R_m = 700 \text{ N/mm}^2$; $R_{p0,2} = 450 \text{ N/mm}^2$; $A_5 > 8\%$ Ductile For $> \text{M}24$: strength class 50 , $R_m = 500 \text{ N/mm}^2$; $R_{p0,2} = 210 \text{ N/mm}^2$; $A_5 > 8\%$ Ductile Stainless steel 1.4401; 1.4404; 1.4578; 1.4571; 1.4439; 1.4362 EN 10088
Washer ISO 7089	Stainless steel 1.4401; 1.4404; 1.4578; 1.4571; 1.4439; 1.4362 EN 10088
Nut EN ISO 4032	Strength class 70 EN ISO 3506-2 Stainless steel 1.4401; 1.4404; 1.4578; 1.4571; 1.4439; 1.4362 EN 10088
Internally threaded sleeves ²⁾ HIS-RN	Stainless steel 1.4401 and 1.4571 EN 10088
Hilti tension anchor HZA-R	Round steel smooth with thread: stainless steel 1.4404 and 1.4571 EN 10088 Rebar B500-B acc. DIN 488-1:2009 and DIN 488-2:2009
Washer ISO 7089	Stainless steel 1.4404 and 1.4571 EN 10088
Nut EN ISO 4032	Strength class 80 EN ISO 3506-2 Stainless steel 1.4404 and 1.4571 EN 10088
Metal parts made of high corrosion resistant steel	
Threaded rod HIT-V-HCR	For $\leq \text{M}20$: $R_m = 800 \text{ N/mm}^2$; $R_{p0,2} = 640 \text{ N/mm}^2$, $A_5 > 8\%$ Ductile For $> \text{M}20$: $R_m = 700 \text{ N/mm}^2$; $R_{p0,2} = 400 \text{ N/mm}^2$, $A_5 > 8\%$ Ductile High corrosion resistant steel 1.4529, 1.4565 EN 10088
Washer ISO 7089	High corrosion resistant steel 1.4529, 1.4565 EN 10088
Nut EN ISO 4032	Strength class 70 EN ISO 3506-2 High corrosion resistant steel 1.4529, 1.4565 EN 10088
Hilti tension anchor HZA-HCR	Round steel smooth with thread: high corrosion resistant steel 1.4529 EN 10088 Rebar B500-B acc. DIN 488-1:2009 and DIN 488-2:2009
Washer ISO 7089	High corrosion resistant steel 1.4529 EN 10088
Nut EN ISO 4032	Strength class 80 EN ISO 3506-2 High corrosion resistant steel 1.4529 EN 10088

- ¹⁾ related fastening screw: strength class 8.8 EN ISO 898-1, $A_5 > 8\%$ Ductile
steel galvanized $\geq 5\mu\text{m}$ EN ISO 4042
- ²⁾ related fastening screw: strength class 70 EN ISO 3506-1, $A_5 > 8\%$ Ductile
stainless steel 1.4401; 1.4404; 1.4578; 1.4571; 1.4439; 1.4362 EN 10088

Injection system Hilti HIT-HY 200-R

Annex 7

Materials

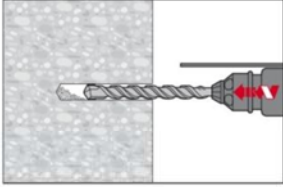
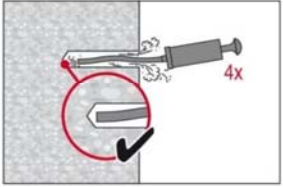
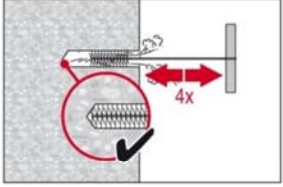
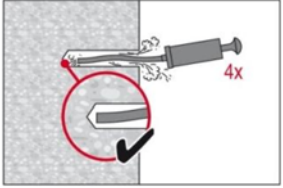
Instruction for use	
Bore hole drilling	
	<p>Drill Hole to the required embedment depth with a hammer drill set in rotation-hammer mode using an appropriately sized carbide drill bit.</p>
Bore hole cleaning Just before setting an anchor, the bore hole must be free of dust and debris.	
<p>a) Manual Cleaning (MC) non-cracked concrete only for bore hole diameters $d_0 \leq 20\text{mm}$ and bore hole depth $h_0 \leq 10d$</p>	
	<p>The Hilti manual pump may be used for blowing out bore holes up to diameters $d_0 \leq 18\text{ mm}$ and embedment depths up to $h_{ef} \leq 10d$.</p> <p>Blow out at least 4 times from the back of the bore hole until return air stream is free of noticeable dust</p>
	<p>Brush 4 times with the specified brush size (brush $\varnothing \geq$ bore hole \varnothing, see Table 7) by inserting the steel brush Hilti HIT-RB to the back of the hole (if needed with extension) in a twisting motion and removing it.</p> <p>The brush must produce natural resistance as it enters the bore hole -- if not the brush is too small and must be replaced with the proper brush diameter.</p>
	<p>Blow out again with manual pump at least 4 times until return air stream is free of noticeable dust.</p>
<p>Injection system Hilti HIT-HY 200-R</p>	
<p>Installation instruction I</p>	
<p>Annex 8</p>	

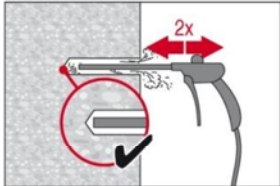
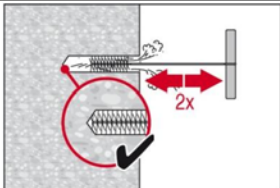
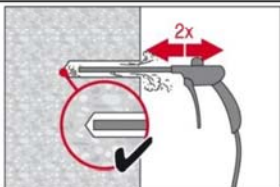
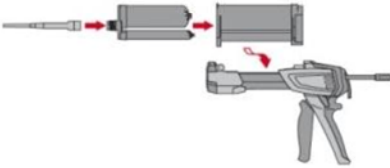
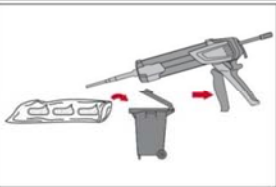
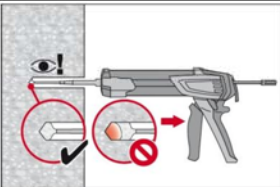
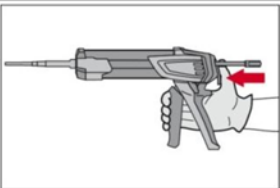
Bore hole cleaning Just before setting an anchor, the bore hole must be free of dust and debris.							
b) Compressed air cleaning (CAC) for all bore hole diameters d_0 and all bore hole depth h_0							
	Blow 2 times from the back of the hole (if needed with nozzle extension) over the hole length with oil-free compressed air (min. 6 bar at 6 m³/h) until return air stream is free of noticeable dust. Bore hole diameter ≥ 32 mm the compressor must supply a minimum air flow of 140 m³/hour.						
	Brush 2 times with the specified brush size (brush $\varnothing \geq$ bore hole \varnothing , see Table 6) by inserting the steel brush Hilti HIT-RB to the back of the hole (if needed with extension) in a twisting motion and removing it. The brush must produce natural resistance as it enters the bore hole -- if not the brush is too small and must be replaced with the proper brush diameter.						
	Blow again with compressed air 2 times until return air stream is free of noticeable dust.						
Injection preparation							
	Tightly attach new Hilti mixing nozzle HIT-RE-M to foil pack manifold (snug fit). Do not modify the mixing nozzle. Observe the instruction for use of the dispenser. Check foil pack holder for proper function. Do not use damaged foil packs / holders. Swing foil pack holder with foil pack into HIT-dispenser.						
	Discard initial adhesive. The foil pack opens automatically as dispensing is initiated. Depending on the size of the foil pack an initial amount of adhesive has to be discarded. Discard quantities are <table border="0"> <tr> <td>2 strokes</td> <td>for 330 ml foil pack,</td> </tr> <tr> <td>3 strokes</td> <td>for 500 ml foil pack,</td> </tr> <tr> <td>4 strokes</td> <td>for 500 ml foil pack $\leq 5^\circ\text{C}$.</td> </tr> </table>	2 strokes	for 330 ml foil pack,	3 strokes	for 500 ml foil pack,	4 strokes	for 500 ml foil pack $\leq 5^\circ\text{C}$.
2 strokes	for 330 ml foil pack,						
3 strokes	for 500 ml foil pack,						
4 strokes	for 500 ml foil pack $\leq 5^\circ\text{C}$.						
Inject adhesive from the back of the borehole without forming air voids							
	Inject the adhesive starting at the back of the hole, slowly withdrawing the mixer with each trigger pull. Fill holes approximately 2/3 full, or as required to ensure that the annular gap between the anchor and the concrete is completely filled with adhesive along the embedment length.						
	After injection is completed, depressurize the dispenser by pressing the release trigger. This will prevent further adhesive discharge from the mixer.						
Injection system Hilti HIT-HY 200-R							
Installation instruction II							
Annex 9							

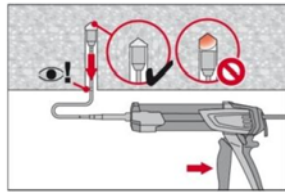

Overhead installation and/or installation with embedment depth $h_{ef} > 250\text{mm}$.

For overhead installation the injection is only possible with the aid of extensions and piston plugs. Assemble HIT-RE-M mixer, extension(s) and appropriately sized piston plug (see Table 8). Insert piston plug to back of the hole and inject adhesive. During injection the piston plug will be naturally extruded out of the bore hole by the adhesive pressure.

Setting the element

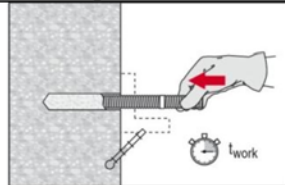

Before use, verify that the element is dry and free of oil and other contaminants.

Mark and set element to the required embedment depth until working time t_{work} has elapsed. The working time t_{work} is given in Table 7.

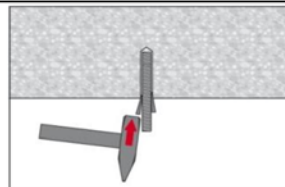

For overhead installation use piston plugs and fix embedded parts with e.g. wedges

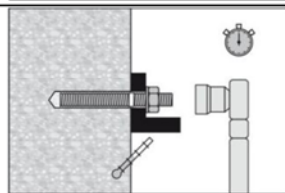

Loading the anchor:

After required curing time t_{cure} (see Table 7) the anchor can be loaded. The applied installation torque shall not exceed the values T_{max} given in Tables 1, 2, 4 and 5.

Table 7: Working time t_{work} and minimum curing time t_{cure}

Temperature in the anchorage base	working time t_{work}	min. curing time t_{cure}
	Hilti HIT-HY200-R	Hilti HIT-HY200-R
-10 °C to -5 °C	3 hour	20 hour
-4 °C to 0 °C	2 hour	7 hour
1 °C to 5 °C	1 hour	3 hour
6 °C to 10 °C	40 min	2 hour
11 °C to 20 °C	15 min	1 hour
21 °C to 30 °C	9 min	1 hour
31 °C to 40 °C	6 min	1 hour

Injection system Hilti HIT-HY 200-R

Annex 10

Installation instruction III
Curing time

Table 8: Borehole diameter specific installation tools:

Reference elements			Drill and clean		Installation
HIT-V	HIS-N	rebar HZA	TE-C TE-Y	HIT-RB	HIT-SZ
					
[mm]	[mm]	[mm]	d ₀ [mm]	HIT-RB	HIT-SZ
8	-	8	10	10	-
10	-	8 / 10	12	12	12
12	8	10 / 12	14	14	14
-	-	12	16	16	16
16	10	14	18	18	18
-	-	16	20	20	20
20	12	-	22	22	22
-	-	20	25	25	25
24	16	-	28	28	28
27	-	-	30	30	30
-	20	25 / 26	32	32	32
30	-	28	35	35	35
-	-	30	37	37	37
-	-	32	40	40	40

Manual Cleaning (MC):

Hilti hand pump for blowing out bore holes with diameters $d_0 \leq 20$ mm and bore hole depth $h_0 \leq 10d$



Compressed air cleaning (CAC):

Air nozzle with an orifice opening of minimum 3,5 mm in diameter.



Injection system Hilti HIT-HY 200-R

Annex 11

Bore hole cleaning
Cleaning sets; brush diameter

Table 9: Design method A, Characteristic values for tension load

Hilti HIT-HY 200-R with HIT-V-...	M8	M10	M12	M16	M20	M24	M27	M30
Steel failure HIT-V-...								
Characteristic resistance HIT-V-5.8(F) $N_{Rk,s}$ [kN]	18	29	42	79	123	177	230	281
Characteristic resistance HIT-V-8.8(F) $N_{Rk,s}$ [kN]	29	46	67	126	196	282	367	449
Partial safety factor $\gamma_{Ms,N}^{1)}$ [-]	1,5							
Characteristic resistance HIT-V-R $N_{Rk,s}$ [kN]	26	41	59	110	172	247	230	281
Partial safety factor $\gamma_{Ms,N}^{1)}$ [-]	1,87						2,86	
Characteristic resistance HIT-V-HCR $N_{Rk,s}$ [kN]	29	46	67	126	196	247	321	393
Partial safety factor $\gamma_{Ms,N}^{1)}$ [-]	1,5					2,1		
Combined Pull-out and Concrete cone failure ³⁾								
Diameter of threaded rod d [mm]	8	10	12	16	20	24	27	30
Characteristic bond resistance in non-cracked concrete C20/25								
Temp. range I ⁴⁾ : 40 °C/24 °C $\tau_{Rk,ucr}$ [N/mm ²]				20		15		
Temp. range II ⁴⁾ : 80 °C/50 °C $\tau_{Rk,ucr}$ [N/mm ²]				17		12		
Temp. range III ⁴⁾ : 120 °C/72 °C $\tau_{Rk,ucr}$ [N/mm ²]				14		11		
Characteristic bond resistance in cracked concrete C20/25								
Temp. range I ⁴⁾ : 40 °C/24 °C $\tau_{Rk,cr}$ [N/mm ²]	6						8	
Temp. range II ⁴⁾ : 80 °C/50 °C $\tau_{Rk,cr}$ [N/mm ²]	4,5						6,5	
Temp. range III ⁴⁾ : 120 °C/72 °C $\tau_{Rk,cr}$ [N/mm ²]	4						5,5	
Partial safety factor $\gamma_{Mp} = \gamma_{Mc} = \gamma_{Msp}^{1)}$ [-]					1,8 ²⁾			
Increasing factor for τ_{Rk} in concrete ψ_c [-]					1,0			
Splitting failure relevant for non cracked concrete ³⁾								
Edge distance $c_{cr,sp}$ [mm] for	$h / h_{ef}^{5)} \geq 2,0$		$1,0 \cdot h_{ef}$					
	$2,0 > h / h_{ef}^{5)} > 1,3$		$4,6 h_{ef} - 1,8 h$					
	$h / h_{ef}^{5)} \leq 1,3$		$2,26 h_{ef}$					
Spacing $s_{cr,sp}$ [mm]					$2 c_{cr,sp}$			
¹⁾ In absence of national regulations ²⁾ The installation safety factor $\gamma_2 = 1,2$ is included. ³⁾ Calculation of concrete failure and splitting see section 4.2 ⁴⁾ Explanation in section 1.2 ⁵⁾ h = thickness of base material; h_{ef} = anchorage depth								
Injection system Hilti HIT-HY 200-R						Annex 12		
Characteristic values for tension load for threaded rods HIT-V-...								

Table 10: Design method A, Characteristic values for shear load

Hilti HIT-HY 200-R with HIT-V-...		M 8	M 10	M 12	M 16	M 20	M 24	M 27	M 30
Steel failure without lever arm									
Characteristic resistance HIT-V-5.8	$V_{Rk,s}$ [kN]	9	15	21	39	61	88	115	140
Characteristic resistance HIT-V-8.8	$V_{Rk,s}$ [kN]	15	23	34	63	98	141	184	224
Characteristic resistance HIT-V-R	$V_{Rk,s}$ [kN]	13	20	30	55	86	124	115	140
Characteristic resistance HIT-V-HCR	$V_{Rk,s}$ [kN]	15	23	34	63	98	124	161	196
Steel failure with lever arm									
Characteristic resistance HIT-V-5.8	$M^o_{Rk,s}$ [Nm]	19	37	66	167	325	561	832	1125
Characteristic resistance HIT-V-8.8	$M^o_{Rk,s}$ [Nm]	30	60	105	266	519	898	1332	1799
Characteristic resistance HIT-V-R	$M^o_{Rk,s}$ [Nm]	26	52	92	233	454	786	832	1124
Characteristic resistance HIT-V-HCR	$M^o_{Rk,s}$ [Nm]	30	60	105	266	520	786	1165	1574
Partial safety factor steel failure									
Partial safety factor HIT-V grade 5.8 or 8.8	$\gamma_{Ms,V}^{1)}$ [-]	1,25							
Partial safety factor HIT-V-R	$\gamma_{Ms,V}^{1)}$ [-]	1,56						2,38	
Partial safety factor HIT-V-HCR	$\gamma_{Ms,V}^{1)}$ [-]	1,25					1,75		
Concrete pryout failure									
Factor in equation (5.7) of Technical Report TR 029 for the design of bonded anchors	k [-]	2,0							
Partial safety factor	$\gamma_{Mcp}^{1)}$ [-]	1,5 ²⁾							
Concrete edge failure									
See section 5.2.3.4 of Technical Report TR 029 for the design of bonded anchors									
Partial safety factor	$\gamma_{Mc}^{1)}$ [-]	1,5 ²⁾							

¹⁾ In absence of national regulations

²⁾ The installation safety factor $\gamma_2 = 1,0$ is included.

Injection system Hilti HIT-HY 200-R

Annex 13

**Characteristic values for shear load
for threaded rods HIT-V-...**

Table 11: Displacements under tension load ¹⁾

Hilti HIT-HY 200-R with HIT-V-...		M8	M10	M12	M16	M20	M24	M27	M30
Non-cracked concrete temperature range I ²⁾: 40 °C / 24 °C									
Displacement	δ_{N0} [mm/(N/mm ²)]	0,02	0,03	0,03	0,04	0,06	0,07	0,07	0,08
Displacement	$\delta_{N\infty}$ [mm/(N/mm ²)]	0,04	0,05	0,06	0,08	0,10	0,13	0,14	0,16
Non-cracked concrete temperature range II ²⁾: 80 °C / 50 °C									
Displacement	δ_{N0} [mm/(N/mm ²)]	0,03	0,04	0,05	0,06	0,08	0,09	0,10	0,12
Displacement	$\delta_{N\infty}$ [mm/(N/mm ²)]	0,04	0,05	0,06	0,09	0,11	0,13	0,15	0,16
Non-cracked concrete temperature range III ²⁾: 120 °C / 72 °C									
Displacement	δ_{N0} [mm/(N/mm ²)]	0,04	0,05	0,06	0,08	0,10	0,12	0,13	0,16
Displacement	$\delta_{N\infty}$ [mm/(N/mm ²)]	0,04	0,05	0,07	0,09	0,11	0,13	0,15	0,17
Cracked concrete temperature range I ²⁾: 40 °C / 24 °C									
Displacement	δ_{N0} [mm/(N/mm ²)]	0,07							
Displacement	$\delta_{N\infty}$ [mm/(N/mm ²)]	0,16							
Cracked concrete temperature range II ²⁾: 80 °C / 50 °C									
Displacement	δ_{N0} [mm/(N/mm ²)]	0,10							
Displacement	$\delta_{N\infty}$ [mm/(N/mm ²)]	0,22							
Cracked concrete temperature range III ²⁾: 120 °C / 72 °C									
Displacement	δ_{N0} [mm/(N/mm ²)]	0,13							
Displacement	$\delta_{N\infty}$ [mm/(N/mm ²)]	0,29							

¹⁾ Calculation of displacement under service load: τ_{sd} design value of bond stress
Displacement under short term loading = $\delta_{N0} \cdot \tau_{sd} / 1,4$;
Displacement under long term loading = $\delta_{N\infty} \cdot \tau_{sd} / 1,4$

²⁾ Explanation see section 1.2

Table 12: Displacement under shear load ¹⁾

Hilti HIT-HY 200-R with HIT-V-...		M8	M10	M12	M16	M20	M24	M27	M30
Displacement	δ_{V0} [mm]/kN	0,06	0,06	0,05	0,04	0,04	0,03	0,03	0,03
Displacement	$\delta_{V\infty}$ [mm]/kN	0,09	0,08	0,08	0,06	0,06	0,05	0,05	0,05

¹⁾ Calculation of displacement under service load: V_{sd} design value of shear stress
Displacement under short term loading = $\delta_{V0} \cdot V_d / 1,4$;
Displacement under long term loading = $\delta_{V\infty} \cdot V_d / 1,4$; (V_d : design value of shear action)

Injection system Hilti HIT-HY 200-R

Annex 14

**Displacements
for threaded rods HIT-V-...**

Table 13: Design method A, Characteristic values for tension load

Hilti HIT-HY 200-R with rebar	Ø8	Ø10	Ø12	Ø14	Ø16	Ø20	Ø25	Ø28	Ø32
Steel failure rebar									
Characteristic resistance for rebar B500 acc. to DIN 488:2009-08 $N_{Rk,s}$ [kN]	28	43	62	85	111	173	270	339	442
Partial safety factor $\gamma_{Ms,N}^{1)}$ [-]	1,4								
Combined Pull-out and Concrete cone failure ³⁾									
Diameter of rebar d [mm]	8	10	12	14	16	20	25	28	32
Characteristic bond resistance in non-cracked concrete C20/25									
Temp. range I ⁴⁾ : 40°C/24°C $\tau_{Rk,ucr}$ [N/mm ²]	12								
Temp. range II ⁴⁾ : 80°C/50°C $\tau_{Rk,ucr}$ [N/mm ²]	10								
Temp. range III ⁴⁾ : 120°C/72°C $\tau_{Rk,ucr}$ [N/mm ²]	8,5								
Characteristic bond resistance in cracked concrete C20/25									
Temp. range I ⁴⁾ : 40°C/24°C $\tau_{Rk,cr}$ [N/mm ²]	-	5					7		
Temp. range II ⁴⁾ : 80°C/50°C $\tau_{Rk,cr}$ [N/mm ²]	-	4					5,5		
Temp. range III ⁴⁾ : 120°C/72°C $\tau_{Rk,cr}$ [N/mm ²]	-	3,5					5		
Partial safety factor $\gamma_{Mp} = \gamma_{Mc} = \gamma_{Msp}^{1)}$ [-]	1,5 ²⁾								
Increasing factor for τ_{Rk} in concrete ψ_c [-]	1,0								
Splitting failure relevant for non cracked concrete ³⁾									
Edge distance $c_{cr,sp}$ [mm] for	$h / h_{ef}^{5)} \geq 2,0$		1,0 · h_{ef}						
	$2,0 > h / h_{ef}^{5)} > 1,3$		4,6 h_{ef} - 1,8 h						
	$h / h_{ef}^{5)} \leq 1,3$		2,26 h_{ef}						
Spacing $s_{cr,sp}$ [mm]	2 c _{cr,sp}								

- 1) In absence of national regulations
- 2) The installation safety factor $\gamma_2 = 1,0$ is included.
- 3) Calculation of concrete failure and splitting see section 4.2
- 4) Explanation in section 1.2
- 5) h = thickness of base material; h_{ef} = anchorage depth

Injection system Hilti HIT-HY 200-R

Annex 15

**Characteristic values for tension load
for rebar**

Table 14: Design method A, Characteristic values for shear load

Hilti HIT-HY 200-R with rebar		Ø8	Ø10	Ø12	Ø14	Ø16	Ø20	Ø25	Ø28	Ø32
Steel failure without lever arm										
Characteristic resistance rebar B500 acc. to DIN 488:2009-08	$V_{Rk,s}$ [kN]	14	22	31	42	55	86	135	169	221
Steel failure with lever arm										
Characteristic resistance rebar B500 acc. to DIN 488:2009-08	$M^o_{Rk,s}$ [Nm]	33	65	112	178	265	518	1012	1422	2123
Partial safety factor steel failure										
Partial safety factor rebar	$\gamma_{Ms,V}^{1)}$ [-]	1,5								
Concrete pryout failure										
Factor in equation (5.7) of Technical Report TR 029 for the design of bonded anchors	k [-]	2,0								
Partial safety factor	$\gamma_{Mcp}^{1)}$ [-]	1,5 ²⁾								
Concrete edge failure										
See section 5.2.3.4 of Technical Report TR 029 for the design of bonded anchors										
Partial safety factor	$\gamma_{Mc}^{1)}$ [-]	1,5 ²⁾								

¹⁾ In absence of national regulations

²⁾ The installation safety factor $\gamma_2 = 1,0$ is included.

Injection system Hilti HIT-HY 200-R

Annex 16

Characteristic values for shear load
for rebar

Table 15: Displacements under tension load ¹⁾

Hilti HIT-HY 200-R with rebar			Ø8	Ø10	Ø12	Ø14	Ø16	Ø20	Ø25	Ø28	Ø32
Non-cracked concrete temperature range I ²⁾: 40 °C / 24 °C											
Displacement	δ_{N0}	[mm/(N/mm ²)]	0,02	0,03	0,03	0,04	0,04	0,06	0,07	0,08	0,09
Displacement	$\delta_{N\infty}$	[mm/(N/mm ²)]	0,04	0,05	0,06	0,07	0,08	0,10	0,13	0,15	0,17
Non-cracked concrete temperature range II ²⁾: 80 °C / 50 °C											
Displacement	δ_{N0}	[mm/(N/mm ²)]	0,03	0,04	0,05	0,05	0,06	0,08	0,10	0,11	0,12
Displacement	$\delta_{N\infty}$	[mm/(N/mm ²)]	0,04	0,05	0,06	0,07	0,09	0,11	0,14	0,15	0,17
Non-cracked concrete temperature range III ²⁾: 120 °C / 72 °C											
Displacement	δ_{N0}	[mm/(N/mm ²)]	0,04	0,05	0,06	0,07	0,08	0,10	0,12	0,14	0,16
Displacement	$\delta_{N\infty}$	[mm/(N/mm ²)]	0,04	0,05	0,07	0,08	0,09	0,11	0,14	0,16	0,18
Cracked concrete temperature range I ²⁾: 40 °C / 24 °C											
Displacement	δ_{N0}	[mm/(N/mm ²)]	0,11								
Displacement	$\delta_{N\infty}$	[mm/(N/mm ²)]	0,16								
Cracked concrete temperature range II ²⁾: 80 °C / 50 °C											
Displacement	δ_{N0}	[mm/(N/mm ²)]	0,15								
Displacement	$\delta_{N\infty}$	[mm/(N/mm ²)]	0,22								
Cracked concrete temperature range III ²⁾: 120 °C / 72 °C											
Displacement	δ_{N0}	[mm/(N/mm ²)]	0,20								
Displacement	$\delta_{N\infty}$	[mm/(N/mm ²)]	0,29								

¹⁾ Calculation of displacement under service load: τ_{sd} design value of bond stress
Displacement under short term loading = $\delta_{N0} \cdot \tau_{sd} / 1,4$;
Displacement under long term loading = $\delta_{N\infty} \cdot \tau_{sd} / 1,4$

²⁾ Explanation see section 1.2

Table 16: Displacement under shear load ¹⁾

Hilti HIT-HY 200-R with rebar			Ø8	Ø10	Ø12	Ø14	Ø16	Ø20	Ø25	Ø28	Ø32
Displacement	δ_{V0}	[mm/kN]	0,06	0,05	0,05	0,04	0,04	0,04	0,03	0,03	0,03
Displacement	$\delta_{V\infty}$	[mm/kN]	0,09	0,08	0,07	0,06	0,06	0,05	0,05	0,04	0,04

¹⁾ Calculation of displacement under service load: V_{sd} design value of shear stress
Displacement under short term loading = $\delta_{V0} \cdot V_d / 1,4$;
Displacement under long term loading = $\delta_{V\infty} \cdot V_d / 1,4$; (V_d : design value of shear action)

Injection system Hilti HIT-HY 200-R

Annex 17

**Displacements
for rebar**

Table 17: Design method A, Characteristic values for tension load

Hilti HIT-HY 200-R with HIS-(R)N		M 8	M 10	M 12	M 16	M 20
Steel failure HIS-(R)N						
Characteristic resistance HIS-N with screw grade 8.8	$N_{Rk,s}$ [kN]	25	46	67	118	109
Partial safety factor	$\gamma_{Ms,N}^{1)}$ [-]	1,43	1,50		1,47	
Characteristic resistance HIS-RN with screw grade 70	$N_{Rk,s}$ [kN]	26	41	59	110	166
Partial safety factor	$\gamma_{Ms,N}^{1)}$ [-]	1,87				2,4
Combined Pull-out and Concrete cone failure ³⁾						
Effective anchorage depth	h_{ef} [mm]	90	110	125	170	205
Effective anchor diameter	d_1 [mm]	12,5	16,5	20,5	25,4	27,6
Characteristic bond resistance in non-cracked concrete C20/25						
Temp. range I ⁴⁾ : 40°C/24°C	$\tau_{Rk,ucr}$ [N/mm ²]	13				
Temp. range II ⁴⁾ : 80°C/50°C	$\tau_{Rk,ucr}$ [N/mm ²]	11				
Temp. range III ⁴⁾ : 120°C/72°C	$\tau_{Rk,ucr}$ [N/mm ²]	9,5				
Characteristic bond resistance in cracked concrete C20/25						
Temp. range I ⁴⁾ : 40°C/24°C	$\tau_{Rk,cr}$ [N/mm ²]	7				
Temp. range II ⁴⁾ : 80°C/50°C	$\tau_{Rk,cr}$ [N/mm ²]	5,5				
Temp. range III ⁴⁾ : 120°C/72°C	$\tau_{Rk,cr}$ [N/mm ²]	5				
Partial safety factor	$\gamma_{Mp} = \gamma_{Mc} = \gamma_{Msp}^{1)}$ [-]	1,5 ²⁾				
Increasing factor for τ_{Rk} in concrete	ψ_c [-]	1,0				
Splitting failure relevant for non cracked concrete ³⁾						
Edge distance $c_{cr,sp}$ [mm] for	$h / h_{ef}^{5)} \geq 2,0$	1,0 · h_{ef}				
	$2,0 > h / h_{ef}^{5)} > 1,3$	4,6 h_{ef} - 1,8 h				
	$h / h_{ef}^{5)} \leq 1,3$	2,26 h_{ef}				
Spacing	$s_{cr,sp}$ [mm]	2 $c_{cr,sp}$				

- 1) In absence of national regulations
- 2) The installation safety factor $\gamma_2 = 1,0$ is included.
- 3) Calculation of concrete failure and splitting see section 4.2
- 4) Explanation in section 1.2
- 5) h = thickness of base material; h_{ef} = anchorage depth

Injection system Hilti HIT-HY 200-R

Annex 18

**Characteristic values for tension load
for internal sleeves HIS-(R)N**

Table 18: Design method A, Characteristic values for shear load

Hilti HIT-HY 200-R with HIS-(R)N		M 8	M 10	M 12	M 16	M 20
Steel failure without lever arm						
Characteristic resistance HIS-N screw grade 8.8	$V_{Rk,s}$ [kN]	13	23	39	59	55
Partial safety factor	$\gamma_{Ms,V}^{1)}$ [-]	1,25		1,5		
Characteristic resistance HIS-RN screw grade 70	$V_{Rk,s}$ [kN]	13	20	30	55	83
Partial safety factor	$\gamma_{Ms,V}^{1)}$ [-]	1,56				2,0
Steel failure with lever arm						
Characteristic resistance HIS-N screw grade 8.8	$M^o_{Rk,s}$ [Nm]	30	60	105	266	519
Partial safety factor	$\gamma_{Ms,V}^{1)}$ [-]	1,25				
Characteristic resistance HIS-RN screw grade 70	$M^o_{Rk,s}$ [Nm]	26	52	92	233	454
Partial safety factor	$\gamma_{Ms,V}^{1)}$ [-]	1,56				
Concrete pryout failure						
Factor in equation (5.7) of Technical Report TR 029 for the design of bonded anchors	k [-]	2,0				
Partial safety factor	$\gamma_{Mcp}^{1)}$ [-]	1,5 ²⁾				
Concrete edge failure						
See section 5.2.3.4 of Technical Report TR 029 for the design of bonded anchors						
Partial safety factor	$\gamma_{Mc}^{1)}$ [-]	1,5 ²⁾				

¹⁾ In absence of national regulations

²⁾ The installation safety factor $\gamma_2 = 1,0$ is included.

Injection system Hilti HIT-HY 200-R

Annex 19

**Characteristic values for shear load
for internal sleeves HIS-(R)N**

Table 19: Displacements under tension load ¹⁾

Hilti HIT-HY 200-R with HIS-(R)N		M8	M10	M12	M16	M20
Non-cracked concrete temperature range I ²⁾: 40 °C / 24 °C						
Displacement δ_{N0}	[mm/(N/mm ²)]	0,03	0,05	0,06	0,07	0,08
Displacement $\delta_{N\infty}$	[mm/(N/mm ²)]	0,06	0,09	0,11	0,13	0,14
Non-cracked concrete temperature range II ²⁾: 80 °C / 50 °C						
Displacement δ_{N0}	[mm/(N/mm ²)]	0,05	0,06	0,08	0,10	0,11
Displacement $\delta_{N\infty}$	[mm/(N/mm ²)]	0,07	0,09	0,11	0,13	0,15
Non-cracked concrete temperature range III ²⁾: 120 °C / 72 °C						
Displacement δ_{N0}	[mm/(N/mm ²)]	0,06	0,08	0,10	0,13	0,14
Displacement $\delta_{N\infty}$	[mm/(N/mm ²)]	0,07	0,09	0,11	0,14	0,15
Cracked concrete temperature range I ²⁾: 40 °C / 24 °C						
Displacement δ_{N0}	[mm/(N/mm ²)]	0,11				
Displacement $\delta_{N\infty}$	[mm/(N/mm ²)]	0,16				
Cracked concrete temperature range II ²⁾: 80 °C / 50 °C						
Displacement δ_{N0}	[mm/(N/mm ²)]	0,15				
Displacement $\delta_{N\infty}$	[mm/(N/mm ²)]	0,22				
Cracked concrete temperature range III ²⁾: 120 °C / 72 °C						
Displacement δ_{N0}	[mm/(N/mm ²)]	0,20				
Displacement $\delta_{N\infty}$	[mm/(N/mm ²)]	0,29				

¹⁾ Calculation of displacement under service load: τ_{Sd} design value of tension load

Displacement under short term loading = $\delta_{N0} \cdot N_{Sd} / 1,4$;

Displacement under long term loading = $\delta_{N\infty} \cdot N_{Sd} / 1,4$

²⁾ Explanation see section 1.2

Table 20: Displacement under shear load ¹⁾

Hilti HIT-HY 200-R with HIS-(R)N		M8	M10	M12	M16	M20
Displacement δ_{V0}	[mm/kN]	0,06	0,06	0,05	0,04	0,04
Displacement $\delta_{V\infty}$	[mm/kN]	0,09	0,08	0,08	0,06	0,06

¹⁾ Calculation of displacement under service load: V_d design value of shear load

Displacement under short term loading = $\delta_{V0} \cdot V_d / 1,4$;

Displacement under long term loading = $\delta_{V\infty} \cdot V_d / 1,4$; (V_d : design value of shear action)

Injection system Hilti HIT-HY 200-R

Annex 20

Displacements
for internal sleeves HIS-(R)N

Table 21: Design method A, Characteristic values for tension load

Hilti HIT-HY 200-R with HZA, HZA-R, HZA-HCR			M12	M16	M20	M24	M27
Steel failure							
Characteristic resistance HZA	$N_{Rk,s}$	[kN]	46	86	135	194	253
Characteristic resistance HZA-R, HZA-HCR	$N_{Rk,s}$	[kN]	62	111	173	270	-
Partial safety factor	$\gamma_{Ms}^{1)}$	[-]	1,4				
Combined pull-out and concrete cone failure³⁾							
Diameter of HZA, HZA-R, HZA-HCR	d	[mm]	12	16	20	25	28
Characteristic bond resistance in non-cracked concrete C20/25							
Temperature range I ⁴⁾ : 40 °C/24 °C	$\tau_{Rk,ucr}$	[N/mm ²]	12				
Temperature range II ⁴⁾ : 80 °C/50 °C	$\tau_{Rk,ucr}$	[N/mm ²]	10				
Temperature range III ⁴⁾ : 120 °C/72 °C	$\tau_{Rk,ucr}$	[N/mm ²]	8,5				
Characteristic bond resistance in cracked concrete C20/25							
Temperature range I ⁴⁾ : 40 °C/24 °C	$\tau_{Rk,cr}$	[N/mm ²]	7				
Temperature range II ⁴⁾ : 80 °C/50 °C	$\tau_{Rk,cr}$	[N/mm ²]	5,5				
Temperature range III ⁴⁾ : 120 °C/72 °C	$\tau_{Rk,cr}$	[N/mm ²]	5				
Partial safety factor	$\gamma_{Mp} = \gamma_{Mc} = \gamma_{Msp}^{1)}$	[-]	1,5 ²⁾				
Increasing factor for τ_{Rk} in concrete	ψ_c	[-]	1,0				
Effective anchorage depth for calculation of $N_{Rk,p}^0$ acc. Eq. 5.2a (TR 029, 5.2.2.3 Combined pull-out and concrete cone failure)	HZA	h_{ef}	[mm]	$h_{nom}^{6)} - 20$			
	HZA-R HZA-HCR	h_{ef}	[mm]	$h_{nom}^{6)} - 100$			
Concrete cone failure³⁾							
Effective anchorage depth for calculation of $N_{Rk,c}^0$ acc. Eq. 5.3a (TR 029, 5.2.2.4 Concrete cone failure)	HZA HZA-R HZA-HCR	h_{ef}	[mm]	$h_{nom}^{6)}$			
Splitting failure relevant for non cracked concrete³⁾							
Edge distance $c_{cr,sp}$ [mm] for	$h / h_{ef}^{5)} \geq 2,0$			1,0 · h_{ef}			
	$2,0 > h / h_{ef}^{5)} > 1,3$			4,6 h_{ef} - 1,8 h			
	$h / h_{ef}^{5)} \leq 1,3$			2,26 h_{ef}			
Spacing	$s_{cr,sp}$	[mm]	2 $c_{cr,sp}$				

- 1) In absence of national regulations
- 2) The installation safety factor $\gamma_2 = 1,0$ is included
- 3) Calculation of concrete failure and splitting see section 4.2
- 4) Explanation see section 1.2
- 5) h = thickness of base material; h_{ef} = anchorage depth
- 6) Limits of h_{nom} see Table 4 for HZA-R, HZA-HCR and Table 5 for HZA

Injection system Hilti HIT-HY 200-R

Annex 21

**Characteristic values for tension load
for HZA, HZA-R, HZA-HCR**

Table 22: Design method A, Characteristic values for shear load

Hilti HIT-HY 200-R with HZA, HZA-R, HZA-HCR		M12	M16	M20	M24	M27
Steel failure without lever arm						
Characteristic resistance HZA	$V_{Rk,s}$ [kN]	23	43	67	97	126
Characteristic resistance HZA-R, HZA-HCR	$V_{Rk,s}$ [kN]	31	55	86	135	-
Partial safety factor	$\gamma_{Ms}^{1)}$ [-]	1,5				
Steel failure with lever arm						
Characteristic resistance HZA	$M_{Rk,s}^0$ [Nm]	72	183	357	617	915
Characteristic resistance HZA-R, HZA-HCR	$M_{Rk,s}^0$ [Nm]	97	234	457	859	-
Partial safety factor	$\gamma_{Ms}^{1)}$ [-]	1,5				
Concrete pryout failure						
Factor in equation (5.7) of Technical Report TR 029 for the design of bonded anchors	k [-]	2,0				
Partial safety factor	$\gamma_{Mcp}^{1)}$ [-]	1,5 ²⁾				
Concrete edge failure						
See section 5.2.3.4 of Technical Report TR 029 for the design of bonded anchors						
Partial safety factor	$\gamma_{Mc}^{1)}$ [-]	1,5 ²⁾				

¹⁾ In absence of national regulations

²⁾ The installation safety factor $\gamma_2 = 1,0$ is included.

Injection system Hilti HIT-HY 200-R

Annex 22

Characteristic values for shear load
for HZA, HZA-R, HZA-HCR

Table 23: Displacements under tension load ¹⁾

Hilti HIT-HY 200-R with HZA, HZA-R, HZA-HCR			M12	M16	M20	M24	M27	
Non-cracked concrete temperature range I ²⁾: 40 °C / 24 °C								
Displacement	δ_{N0}	[mm/(N/mm ²)]	0,03	0,04	0,06	0,07	0,08	
Displacement	$\delta_{N\infty}$	[mm/(N/mm ²)]	0,06	0,08	0,13	0,13	0,15	
Non-cracked concrete temperature range II ²⁾: 80 °C / 50 °C								
Displacement	δ_{N0}	[mm/(N/mm ²)]	0,05	0,06	0,08	0,10	0,11	
Displacement	$\delta_{N\infty}$	[mm/(N/mm ²)]	0,06	0,09	0,14	0,14	0,15	
Non-cracked concrete temperature range III ²⁾: 120 °C / 72 °C								
Displacement	δ_{N0}	[mm/(N/mm ²)]	0,06	0,08	0,10	0,12	0,14	
Displacement	$\delta_{N\infty}$	[mm/(N/mm ²)]	0,07	0,09	0,14	0,14	0,16	
Cracked concrete temperature range I ²⁾: 40 °C / 24 °C								
Displacement	δ_{N0}	[mm/(N/mm ²)]	0,11					
Displacement	$\delta_{N\infty}$	[mm/(N/mm ²)]	0,16					
Cracked concrete temperature range II ²⁾: 80 °C / 50 °C								
Displacement	δ_{N0}	[mm/(N/mm ²)]	0,15					
Displacement	$\delta_{N\infty}$	[mm/(N/mm ²)]	0,22					
Cracked concrete temperature range III ²⁾: 120 °C / 72 °C								
Displacement	δ_{N0}	[mm/(N/mm ²)]	0,20					
Displacement	$\delta_{N\infty}$	[mm/(N/mm ²)]	0,29					

- ¹⁾ Calculation of displacement under service load: τ_{sd} design value of bond stress
Displacement under short term loading = $\delta_{N0} \cdot \tau_{sd} / 1,4$;
Displacement under long term loading = $\delta_{N\infty} \cdot \tau_{sd} / 1,4$
- ²⁾ Explanation see section 1.2

Table 24: Displacement under shear load ¹⁾

Hilti HIT-HY 200-R with HZA, HZA-R, HZA-HCR			M12	M16	M20	M24	M27
Displacement	δ_{V0}	[mm]	0,05	0,04	0,04	0,03	0,03
Displacement	$\delta_{V\infty}$	[mm]	0,08	0,06	0,06	0,05	0,05

- ¹⁾ Calculation of displacement under service load: V_{sd} design value of shear stress
Displacement under short term loading = $\delta_{V0} \cdot V_d / 1,4$
Displacement under long term loading = $\delta_{V\infty} \cdot V_d / 1,4$

Injection system Hilti HIT-HY 200-R

Annex 23

Displacements
for HZA, HZA-R, HZA-HCR