



European Technical Approval ETA-12/0160

English translation prepared by DIBt - Original version in German language

Handelsbezeichnung <i>Trade name</i>	fischer Powerbond - Injektionssystem <i>fischer Powerbond - injection system</i>
Zulassungsinhaber <i>Holder of approval</i>	fischerwerke GmbH & Co. KG Otto-Hahn-Straße 15 79211 Denzlingen DEUTSCHLAND
Zulassungsgegenstand und Verwendungszweck <i>Generic type and use of construction product</i>	Verbunddübel mit Ankerstange und Hülse in den Größen M10, M12 und M16 im Beton <i>Bonded anchor with steel element and sleeve of sizes M10, M12 and M16 for use in concrete</i>
Geltungsdauer: <i>Validity:</i>	vom <i>from</i> bis <i>to</i> 5 September 2012 18 April 2017
Herstellwerk <i>Manufacturing plant</i>	fischerwerke

Diese Zulassung umfasst
This Approval contains

16 Seiten einschließlich 8 Anhänge
16 pages including 8 annexes

Diese Zulassung ersetzt
This Approval replaces

ETA-12/0160 mit Geltungsdauer vom 18.04.2012 bis 18.04.2017
ETA-12/0160 with validity from 18.04.2012 to 18.04.2017

I LEGAL BASES AND GENERAL CONDITIONS

- 1 This European technical approval is issued by Deutsches Institut für Bautechnik in accordance with:
 - Council Directive 89/106/EEC of 21 December 1988 on the approximation of laws, regulations and administrative provisions of Member States relating to construction products¹, modified by Council Directive 93/68/EEC² and Regulation (EC) N° 1882/2003 of the European Parliament and of the Council³;
 - *Gesetz über das In-Verkehr-Bringen von und den freien Warenverkehr mit Bauprodukten zur Umsetzung der Richtlinie 89/106/EWG des Rates vom 21. Dezember 1988 zur Angleichung der Rechts- und Verwaltungsvorschriften der Mitgliedstaaten über Bauprodukte und anderer Rechtsakte der Europäischen Gemeinschaften (Bauproduktengesetz - BauPG) vom 28. April 1998⁴, as amended by Article 2 of the law of 8 November 2011⁵;*
 - Common Procedural Rules for Requesting, Preparing and the Granting of European technical approvals set out in the Annex to Commission Decision 94/23/EC⁶;
 - Guideline for European technical approval of "Metal anchors for use in concrete - Part 5: Bonded anchors", ETAG 001-05.
- 2 Deutsches Institut für Bautechnik is authorized to check whether the provisions of this European technical approval are met. Checking may take place in the manufacturing plant. Nevertheless, the responsibility for the conformity of the products to the European technical approval and for their fitness for the intended use remains with the holder of the European technical approval.
- 3 This European technical approval is not to be transferred to manufacturers or agents of manufacturers other than those indicated on page 1, or manufacturing plants other than those indicated on page 1 of this European technical approval.
- 4 This European technical approval may be withdrawn by Deutsches Institut für Bautechnik, in particular pursuant to information by the Commission according to Article 5(1) of Council Directive 89/106/EEC.
- 5 Reproduction of this European technical approval including transmission by electronic means shall be in full. However, partial reproduction can be made with the written consent of Deutsches Institut für Bautechnik. In this case partial reproduction has to be designated as such. Texts and drawings of advertising brochures shall not contradict or misuse the European technical approval.
- 6 The European technical approval is issued by the approval body in its official language. This version corresponds fully to the version circulated within EOTA. Translations into other languages have to be designated as such.

¹ Official Journal of the European Communities L 40, 11 February 1989, p. 12

² Official Journal of the European Communities L 220, 30 August 1993, p. 1

³ Official Journal of the European Union L 284, 31 October 2003, p. 25

⁴ *Bundesgesetzblatt Teil I 1998*, p. 812

⁵ *Bundesgesetzblatt Teil I 2011*, p. 2178

⁶ Official Journal of the European Communities L 17, 20 January 1994, p. 34

II SPECIFIC CONDITIONS OF THE EUROPEAN TECHNICAL APPROVAL

1 Definition of the product and intended use

1.1 Definition of the construction product

The Fischer Powerbond - injection system is a bonded anchor consisting of a mortar cartridge with injection mortar FIS PM and a steel element. The steel element is an anchor rod with hexagon nut and washer made of zinc coated steel, stainless steel A4 or high corrosion resistant steel and the Fischer Power Sleeve FIS PS made of stainless steel or high corrosion resistant steel of sizes M10, M12 or M16.

The steel element is placed into a drilled hole filled with injection mortar and is anchored via the bond between steel element, injection mortar and concrete.

An illustration of the product and intended use is given in Annex 1.

1.2 Intended use

The anchor is intended to be used for anchorages for which requirements for mechanical resistance and stability and safety in use in the sense of the Essential Requirements 1 and 4 of Council Directive 89/106 EEC shall be fulfilled and failure of anchorages made with these products would cause risk to human life and/or lead to considerable economic consequences. Safety in case of fire (Essential Requirement 2) is not covered in this European technical approval. The anchor is to be used only for anchorages subject to static or quasi-static loading in reinforced or unreinforced normal weight concrete of strength classes C20/25 at minimum and C50/60 at most according to EN 206:2000-12.

The anchor may be installed in cracked or non-cracked concrete.

The anchor may be installed in dry or wet concrete; it may be installed in flooded holes.

The drill hole shall be made by hammer drilling or diamond drilling.

The anchor may be used in the following service temperature range:

Temperature range I:	-40 °C to +50 °C	(max long term temperature +24 °C and max short term temperature +50 °C)
Temperature range II:	-40 °C to +80 °C	(max long term temperature +50 °C and max short term temperature +80 °C)

Elements made of zinc coated steel:

The element made of electroplated or hot-dipped galvanised steel may only be used in structures subject to dry internal conditions.

Elements made of stainless steel A4:

The element made of stainless steel may be used in structures subject to dry internal conditions and also in structures subject to external atmospheric exposure (including industrial and marine environment), or exposure in permanently damp internal conditions, if no particular aggressive conditions exist. Such particular aggressive conditions are e.g. permanent, alternating immersion in seawater or the splash zone of seawater, chloride atmosphere of indoor swimming pools or atmosphere with extreme chemical pollution (e.g. in desulphurization plants or road tunnels where de-icing materials are used).

Elements made of high corrosion resistant steel:

The element made of high corrosion resistant steel may be used in structures subject to dry internal conditions and also in structures subject to external atmospheric exposure, in permanently damp internal conditions or in other particular aggressive conditions. Such particular aggressive conditions are e. g. permanent, alternating immersion in seawater or the splash zone of seawater, chloride atmosphere of indoor swimming pools or atmosphere with chemical pollution (e.g. in desulphurization plants or road tunnels where de-icing materials are used).

The provisions made in this European technical approval are based on an assumed working life of the anchor of 50 years. The indications given on the working life cannot be interpreted as a guarantee given by the producer, but are to be regarded only as a means for choosing the right products in relation to the expected economically reasonable working life of the works.

2 Characteristics of the product and methods of verification

2.1 Characteristics of product

The anchor corresponds to the drawings and provisions given in Annexes 1 to 3. The characteristic material values, dimensions and tolerances of the anchor not indicated in Annexes 1 to 3 shall correspond to the respective values laid down in the technical documentation⁷ of this European technical approval.

The characteristic anchor values for the design of anchorages are given in Annexes 6 to 8.

Each mortar cartridge is marked with the imprint "FIS PM", processing notes, piston travel scale, processing and curing time (depending on temperature), hazard code and shelf life in accordance with Annex 1.

The two components of the injection mortar FIS-PM are delivered in unmixed condition in mortar cartridges according to Annex 1.

Each fischer Power Sleeve FIS PS is marked with the letters "PS" according to Annex 2.

Each anchor rod is marked according to Annex 2. The embedment depth may be marked on jobsite.

2.2 Methods of verification

The assessment of fitness of the anchor for the intended use in relation to the requirements for mechanical resistance and stability and safety in use in the sense of the Essential Requirements 1 and 4 has been made in accordance with the "Guideline for European technical approval of Metal Anchors for Use in Concrete", Part 1 "Anchors in general" and Part 5 "Bonded anchors" on the basis of Option 1.

In addition to the specific clauses relating to dangerous substances contained in this European technical approval, there may be other requirements applicable to the products falling within its scope (e.g. transposed European legislation and national laws, regulations and administrative provisions). In order to meet the provisions of the Construction Products Directive, these requirements need also to be complied with, when and where they apply.

⁷ The technical documentation of this European technical approval is deposited at the Deutsches Institut für Bautechnik and, as far as relevant for the tasks of the approved bodies involved in the attestation of conformity procedure, is handed over to the approved bodies.

3 Evaluation and attestation of conformity and CE marking

3.1 System of attestation of conformity

According to the Decision 96/582/EG of the European Commission⁸ system 2(i) (referred to as System 1) of the attestation of conformity applies.

This system of attestation of conformity is defined as follows:

System 1: Certification of the conformity of the product by an approved certification body on the basis of:

- (a) Tasks for the manufacturer:
 - (1) factory production control;
 - (2) further testing of samples taken at the factory by the manufacturer in accordance with a prescribed control plan;
- (b) Tasks for the approved body:
 - (3) initial type-testing of the product;
 - (4) initial inspection of factory and of factory production control;
 - (5) continuous surveillance, assessment and approval of factory production control.

Note: Approved bodies are also referred to as "notified bodies".

3.2 Responsibilities

3.2.1 Tasks for the manufacturer

3.2.1.1 Factory production control

The manufacturer shall exercise permanent internal control of production. All the elements, requirements and provisions adopted by the manufacturer shall be documented in a systematic manner in the form of written policies and procedures, including records of results performed. This production control system shall insure that the product is in conformity with this European technical approval.

The manufacturer may only use initial/raw/constituent materials stated in the technical documentation of this European technical approval.

The factory production control shall be in accordance with the control plan which is part of the technical documentation of this European technical approval. The control plan is laid down in the context of the factory production control system operated by the manufacturer and deposited with Deutsches Institut für Bautechnik.⁹

The results of factory production control shall be recorded and evaluated in accordance with the provisions of the control plan.

3.2.1.2 Other tasks for the manufacturer

The manufacturer shall, on the basis of a contract, involve a body which is approved for the tasks referred to in section 3.1 in the field of anchors in order to undertake the actions laid down in section 3.2.2 For this purpose, the control plan referred to in sections 3.2.1.1 and 3.2.2 shall be handed over by the manufacturer to the approved body involved.

The manufacturer shall make a declaration of conformity, stating that the construction product is in conformity with the provisions of this European technical approval.

⁸ Official Journal of the European Communities L 254 of 08.10.1996

⁹ The control plan is a confidential part of the European technical approval and only handed over to the approved body involved in the procedure of attestation of conformity. See section 3.2.2.

3.2.2 Tasks for the approved bodies

The approved body shall perform the

- initial type-testing of the product,
- initial inspection of factory and of factory production control,
- continuous surveillance, assessment and approval of factory production control,

in accordance with the provisions laid down in the control plan.

The approved body shall retain the essential points of its actions referred to above and state the results obtained and conclusions drawn in a written report.

The approved certification body involved by the manufacturer shall issue an EC certificate of conformity of the product stating the conformity with the provisions of this European technical approval.

In cases where the provisions of the European technical approval and its control plan are no longer fulfilled the certification body shall withdraw the certificate of conformity and inform Deutsches Institut für Bautechnik without delay.

3.3 CE marking

The CE marking shall be affixed on each packaging of the anchor. The letters "CE" shall be followed by the identification number of the approved certification body, where relevant, and be accompanied by the following additional information:

- the name and address of the producer (legal entity responsible for the manufacture),
- the last two digits of the year in which the CE marking was affixed,
- the number of the EC certificate of conformity for the product,
- the number of the European technical approval,
- the number of the guideline for European technical approval,
- use category (ETAG 001-1 Option 1),
- size.

4 Assumptions under which the fitness of the product for the intended use was favourably assessed

4.1 Manufacturing

The European technical approval is issued for the product on the basis of agreed data/information, deposited with Deutsches Institut für Bautechnik, which identifies the product that has been assessed and judged. Changes to the product or production process, which could result in this deposited data/information being incorrect, should be notified to Deutsches Institut für Bautechnik before the changes are introduced.

Deutsches Institut für Bautechnik will decide whether or not such changes affect the approval and consequently the validity of the CE marking on the basis of the approval and if so whether further assessment or alterations to the approval shall be necessary.

4.2 Design of anchorages

The fitness of the anchor for the intended use is given under the following conditions:

The anchorages are designed in accordance with the EOTA Technical Report TR 029 "Design of bonded anchors"¹⁰ under the responsibility of an engineer experienced in anchorages and concrete work.

Verifiable calculation notes and drawings are prepared taking account of the loads to be anchored.

The position of the anchor is indicated on the design drawings (e.g. position of the anchor relative to reinforcement or to supports, etc.).

4.3 Installation of anchors

The fitness for use of the anchor can only be assumed if the anchor is installed as follows:

- Anchor installation carried out by appropriately qualified personnel and under the supervision of the person responsible for technical matters of the site,
- Anchor installation in accordance with the manufacturer's specifications and drawings using the tools indicated in the technical documentation of this European technical approval,
- Checks before placing the anchor to ensure that the strength class of the concrete in which the anchor is to be placed is in the range given and is not lower than that of the concrete to which the characteristic loads apply,
- Check of concrete being well compacted, e.g. without significant voids,
- Marking and keeping the effective anchorage depth,
- Edge distance and spacing not less than the specified values without minus tolerances,
- Positioning of the drill holes without damaging the reinforcement,
- Drilling by hammer drilling or diamond drilling,
- In case of aborted drill hole: the drill hole shall be filled with mortar,
- Anchor installation in accordance with manufacturers installation instructions acc. to Annex 4 and 5, the Fischer Power Sleeve PS shall be fully set into the concrete before Mortar injection,
- During installation and curing of the chemical mortar the anchor component temperature shall be at least +5 °C,
- During curing of the chemical mortar the temperature of the concrete must not fall below -5 °C; observing the curing time according to Annex 5 Table 3 until the anchor may be loaded,
- Installation torque moments are not required for functioning of the anchor. However, the torque moments given in Annex 3, Table 1 must not be exceeded.

5 Indications to the manufacture

5.1 Responsibility of the manufacturer

It is in the responsibility of the manufacturer to ensure that the information on the specific conditions according to 1 and 2 including Annexes referred to as well as sections 4.2, 4.3 and 5.2 is given to those who are concerned. This information may be made by reproduction of the respective parts of the European technical approval. In addition all installation data shall be shown clearly on the package and/or on an enclosed instruction sheet, preferably using illustration(s).

¹⁰ The Technical Report TR 029 "Design of Bonded Anchors" is published in English on EOTA website www.eota.eu.

The minimum data required are:

- drill bit;
- diameter of anchor rod;
- information on the installation procedure, including cleaning of the hole with the cleaning equipments, preferably by means of an illustration;
- anchor component installation temperature;
- material and property class of metal parts acc. to Annex 3, Table 2;
- ambient temperature of the concrete during installation of the anchor;
- admissible processing time (open time) of a cartridge;
- curing time until the anchor may be loaded as a function of the ambient temperature in the concrete during installation;
- identification of the manufacturing batch.

All data shall be presented in a clear and explicit form.

5.2 Recommendations concerning packaging, transport and storage

The injection cartridges shall be protected against sun radiation and shall be stored according to the manufacture's installation instructions in dry condition at temperatures of at least +5 °C to not more than +25 °C.

Mortar cartridges with expired shelf life must no longer be used.

Georg Feistel
Head of Department

beglaubigt:
Baderschneider

Shuttle cartridge (360 ml and 950 ml)

Imprint: FIS PM, processing notes, piston travel scale, processing and curing times (depending on temperature), hazard code, shelf life

Sealing cap

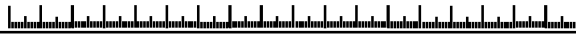
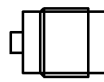

Static mixer

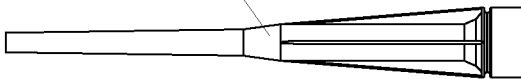

Coaxial cartridge (150 ml and 300 ml)

Imprint: FIS PM, processing notes, piston travel scale, processing and curing times (depending on temperature), hazard code, shelf life

Sealing cap

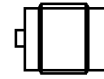

Cleaning brush

Cleaning nozzle

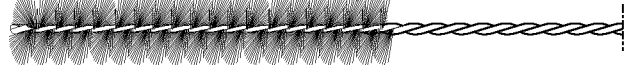
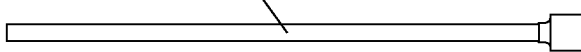

Anchor rod

Size: M10, M12, M16

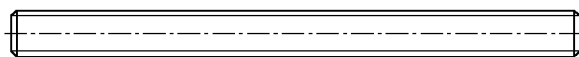

Washer



Hexagon nut



fischer Power Sleeve FIS PS

Size: FIS PS M10, FIS PS M12, FIS PS M16

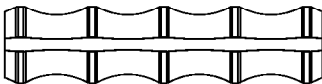

Temperature range: -40°C to + 80°C (max. short term temperature + 80°C;
max. long term temperature + 50°C)

Intended use in dry and wet concrete and flooded holes

Injection system fischer Powerbond

Products
Intended use

Annex 1

fischer anchor rod

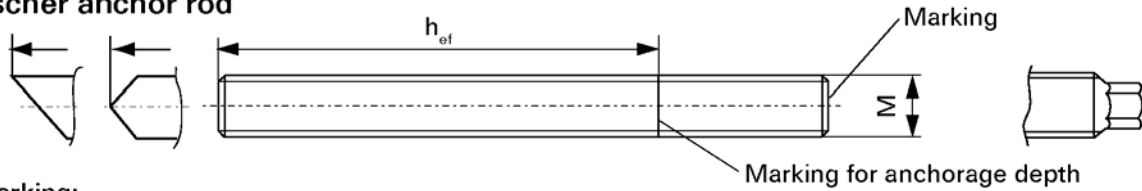

Marking:

Property class 8.8, stainless steel A4- 80 or high corrosion-resistant steel, property class 80: •
Stainless steel A4, property class 50 and high corrosion-resistant steel C, property class 50: ••

fischer Power Sleeve FIS PS

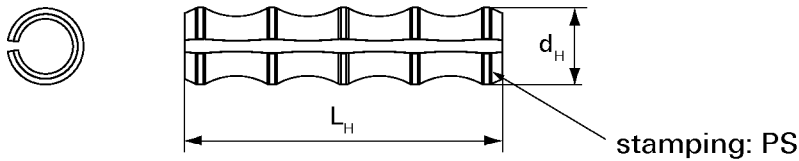

Steelbrush

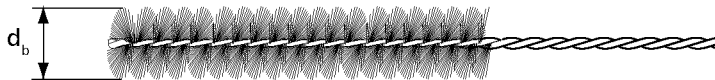

Application range

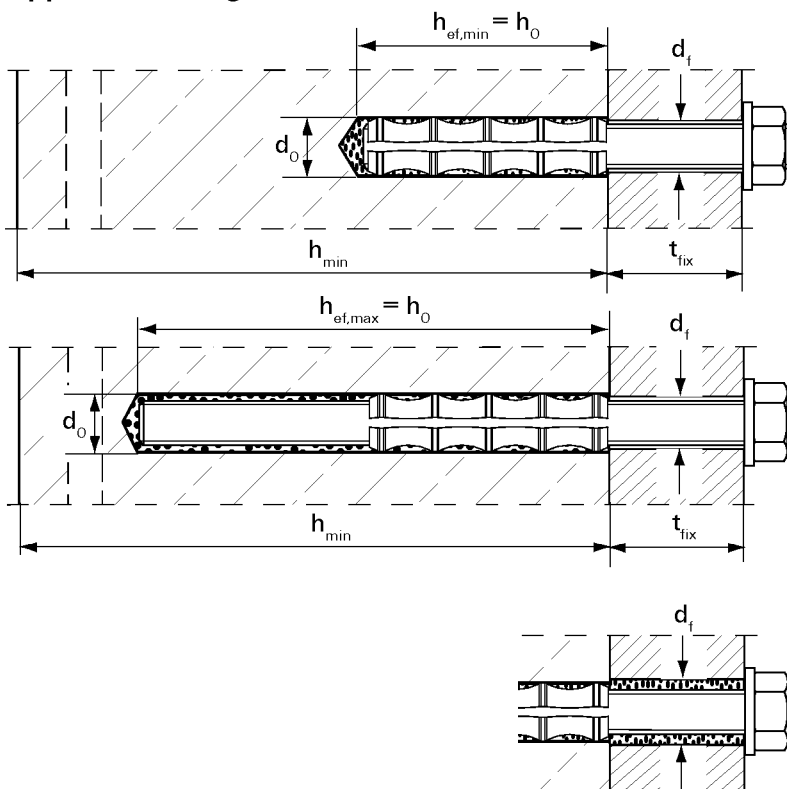

$h_{ef,min} =$ sleeve length L_H
(see Table 1)

$h_{ef,max} >$ sleeve length L_H
(see Table 1)

Push-through installation
(annual clearance filled
with mortar)

Injection system fischer Powerbond

Dimensions
Application range

Annex 2

Table 1: Installation parameters fischer Powerbond

Size		M10	M12	M16
Nominal drill bit diameter	d_o [mm]	14	16	20
Depth of drill hole	h_o [mm]	$h_o = h_{ef}$		
Brush diameter	d_b [mm]	16	20	25
Length of steel sleeve	L_H [mm]	60	72	96
Diameter of steel sleeve	d_H [mm]	14	16	20
Effective anchorage depth ¹⁾	$h_{ef,min}$ [mm]	60	72	96
6xd up to 12xd	$h_{ef,max}$ [mm]	120	144	192
Minimum spacing and minimum edge distance for $h_{ef,min} \leq h_{ef} \leq h_{ef,max}$				
Cracked concrete	$s_{min} = c_{min}$ [mm]	50	55	60
Non-cracked concrete	$s_{min} = c_{min}$ [mm]	55	55	65
Diameter of pre-positioned anchorage $\leq d_f$ [mm]		12	14	18
hole in the fixture ²⁾ in-place anchorage $\leq d_f$ [mm]		15	17	21
Minimum thickness of concrete member	h_{min} [mm]	$h_{ef} + 30$ (≥ 100)	$h_{ef} + 2d_o$	
Max. torque moment	$T_{inst,max}$ [Nm]	20	40	60
Thickness of fixture	$t_{fix,min}$ [mm]	0		
	$t_{fix,max}$ [mm]	6000		

¹⁾ $h_{ef,min} \leq h_{ef} \leq h_{ef,max}$ is possible

²⁾ For larger diameter of clearance hole see chapter 1.1 of TR 029

Table 2: Materials

Designation	Material		
	Steel, zinc plated	Stainless steel A4	High corrosion-resistant steel
Anchor rod	Property class 5.8 or 8.8; EN ISO 898-1 zinc plated $\geq 5\mu\text{m}$, EN ISO 4042 A2K or hot-dip galvanised EN ISO 10684	Property class 50 or 70 or 80 EN ISO 3506 1.4401; 1.4404; 1.4578; 1.4571; 1.4439; 1.4362 EN 10088 or 1.4062 pr EN 10088:2011	Property class 50 or 80 EN ISO 3506 or property class 70 with $f_{yk} \geq 560 \text{ N/mm}^2$ for 1.4529; 1.4565 EN 10088
Washer EN ISO 7089	zinc plated $\geq 5\mu\text{m}$, EN ISO 4042 A2K or hot-dip galvanised EN ISO 10684	1.4401; 1.4404; 1.4578; 1.4571; 1.4439; 1.4362 EN 10088	1.4565; 1.4529 EN 10088
Hexagon nut according to EN 24032	Property class 5 or 8; EN ISO 898-1 zinc plated $\geq 5\mu\text{m}$, EN ISO 4042 A2K or hot-dip galvanised EN ISO 10684	Property class 50 or 70 or 80 EN ISO 3506 1.4401; 1.4404; 1.4578; 1.4571; 1.4439; 1.4362 EN 10088	Property class 50 or 70 or 80 EN ISO 3506 1.4529; 1.4565 EN 10088
Power Sleeve	Stainless steel A4		High corrosion-resistant steel 1.4565; 1.4529

Injection system fischer Powerbond

Installation parameters
Materials

Annex 3

Hammer-drill (drilling and cleaning the hole)

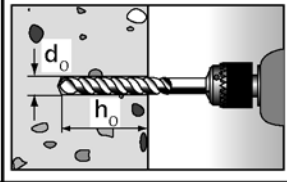
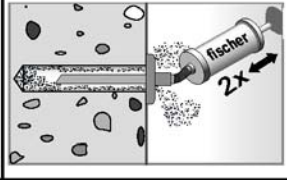
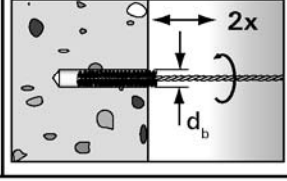
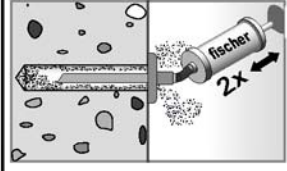
<p>1</p> 	<p>Drill the hole. Drill hole diameter d_0 and drill hole depth h_0 see Table 1.</p>
<p>2</p> 	<p>Blow out at least 2 times from the back of the bore hole with manual pump.</p>
<p>3</p> 	<p>Brush 2 times with the specified steel brush from the back of the hole (if needed with extension). The brush must produce natural resistance while entering the bore hole. If not, the brush is too small and must be replaced with a proper brush. Brush diameters see Table 1.</p>
<p>4</p> 	<p>Blow out again 2 times from the back of the bore hole with manual pump.</p>

Diamond-drill (drilling and cleaning the hole)

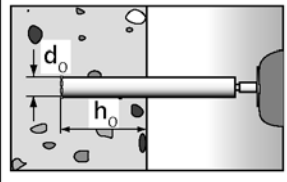
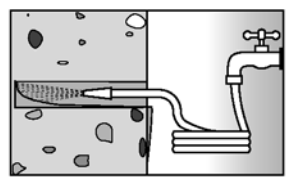
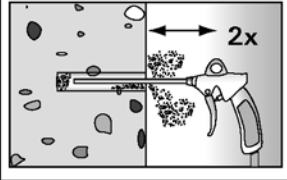
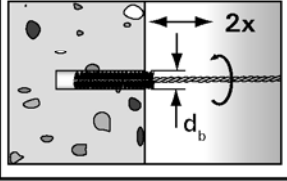
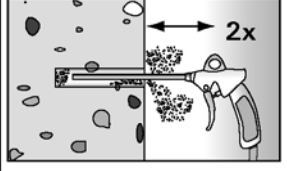
<p>1</p> 	<p>Drill the hole. Drill hole diameter d_0 and drill hole depth h_0 see Table 1.</p>		<p>Remove the drill cone. Flushing the drill hole until the water is clear.</p>
<p>2</p> 	<p>Blow 2 times from the back of the hole (if needed with nozzle extension) over the hole length with oil free compressed air (6 bar)</p>		
<p>3</p> 	<p>Brush 2 times with the specified steel brush from the back of the hole (if needed with extension). The brush must produce natural resistance while entering the bore hole. If not, the brush is too small and must be replaced with a proper brush. Brush diameters see Table 1.</p>		
<p>4</p> 	<p>Blow again 2 times from the back of the hole (if needed with nozzle extension) over the hole length with oil free compressed air (6 bar)</p>		

Injection system fischer Powerbond

Installation instruction
Part 1

Annex 4

Preparing the cartridge

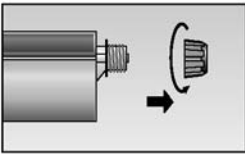
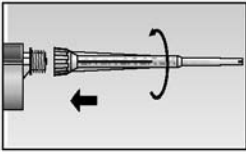
5  Twist off the sealing cap  Tightly attach the static mixer to the cartridge. Make sure the mixing element is in the mixer.

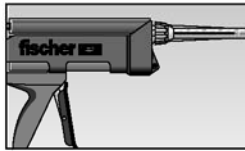
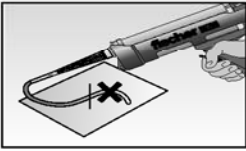
6  Place the cartridge into the dispenser.  The initial amount of adhesive has to be discarded (length of the initial of adhesive ~ 10 cm).

Installation Power Sleeve and anchor rods

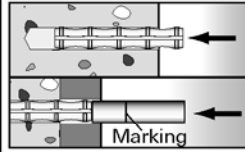
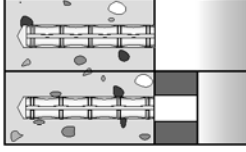
7  Insert the Power Sleeve into the clean drill hole. For push-through installation use an acceptable tool with marked setting depth.  The Power Sleeve must be even with the surface of the concrete.

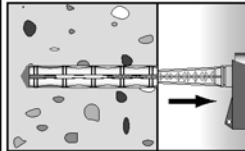
8  Fill approx. 2/3 of the drill hole through the Power Sleeve with Power Mortar FIS PM beginning from the back of the hole, slowly withdrawing the mixer with each trigger pull. If it is necessary use an extension.

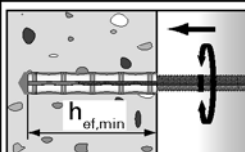
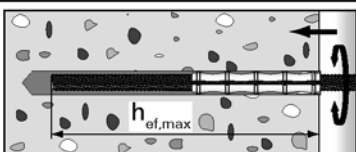
9   Press the anchor rod down to the bottom of the hole, turning it slightly while doing so.
 $h_{ef,min}$ and $h_{ef,max}$ see Table 1



10  For correct installation excess mortar must emerge from the drill hole after reaching the setting depth. Otherwise remove the anchor rod immediately and re-inject additional amount of FIS PM mortar. For push-through installations the annual clearance has to be filled with mortar.  Wait for the specified curing time. t_{cure} see Table 3.

Table 3: Processing times and curing times

Concrete temperature	Processing time	Curing time ¹⁾ t_{cure}
- 5°C to + 0°C	—	360 minutes
> + 0°C to + 5°C	—	180 minutes
> + 5°C to + 20°C	15 minutes	90 minutes
> + 20°C to + 30°C	6 minutes	35 minutes
> + 30°C to + 40°C	4 minutes	20 minutes
> +40°C	2 minutes	12 minutes

¹⁾For wet concrete and flooded holes the curing times must be doubled.

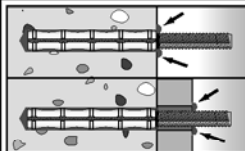
11  Mounting the fixture.
 $T_{inst,max}$ see Table 1.

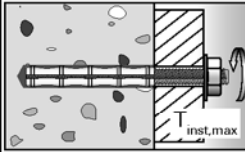
Injection system fischer Powerbond

Installation instruction
Part 2

Annex 5

Table 3: Characteristic values to tension load

Size			M 10	M 12	M 16	
Steel failure						
Characteristic resistance $N_{Rk,s}$	Property class	5.8 [kN]	29	43	79	
		8.8 [kN]	47	68	126	
	Stainless steel A4	Property class	50 [kN]	29	43	79
			70 [kN]	41	59	110
	High corrosion-resistant steel C	Property class	80 [kN]	47	68	126
			50 [kN]	29	43	79
			70 ²⁾ [kN]	41	59	110
			80 [kN]	47	68	126
Partial safety factor $\gamma_{Ms,N}$ ¹⁾	Property class	5.8 [-]		1,50		
		8.8 [-]		1,50		
	Stainless steel A4	Property class	50 [-]		2,86	
			70 [-]		1,87	
	High corrosion-resistant steel C	Property class	80 [-]		1,50	
			50 [-]		2,86	
			70 ²⁾ [-]		1,50	
			80 [-]		1,60	
Pullout and concrete cone failure in cracked concrete C20/25						
Size			M 10	M 12	M 16	
Diameter for calculation d [mm]			10	12	16	
Characteristic resistance $\tau_{Rk,cr}$ [N/mm ²]			10	10	10	
Pullout and splitting failure in non-cracked concrete C20/25						
Characteristic resistance $\tau_{Rk,ucr}$ [N/mm ²]			13	13	13 (12) ⁵⁾	
Increasing factors ψ_c for τ_{Rk}	C25/30 [-]			1,06		
	C30/37 [-]			1,12		
	C35/45 [-]			1,19		
	C40/50 [-]			1,23		
	C45/55 [-]			1,27		
	C50/60 [-]			1,30		
Edge distance	$h_{ef}/d \leq 8$	$c_{cr,sp}$ [mm]	$1,75 \cdot h_{ef}$	$1,85 \cdot h_{ef}$	$1,95 \cdot h_{ef}$	
	$h_{ef}/d > 8$	$c_{cr,sp}$ [mm]		$1,5 \cdot h_{ef}$		
Spacing $s_{cr,sp}$ [mm]				$2 \cdot c_{cr,sp}$		
Partial safety factor γ_{Mc} ¹⁾	dry and wet [-]			1,5 ³⁾		
	flooded hole [-]			1,8 ⁴⁾		

¹⁾ In absence of other national regulations.

²⁾ $f_{uk} = 700 \text{ N/mm}^2$; $f_{yk} = 560 \text{ N/mm}^2$

³⁾ The partial safety factor $\gamma_2 = 1,0$ is included

⁴⁾ The partial safety factor $\gamma_2 = 1,2$ is included

⁵⁾ $h_{ef} > 9d$

Injection system fischer Powerbond

Characteristic values to tension load

Annex 6

Table 4: Characteristic values to shear load

Size				M 10	M 12	M 16	
Steel failure without lever arm							
Characteristic resistance $V_{Rk,s}$	Property class	5.8	[kN]	15	21	39	
		8.8	[kN]	23	34	63	
	Stainless steel A4	Property class	50	[kN]	15	21	39
			70	[kN]	20	30	55
		80	[kN]	23	34	63	
	High corrosion-resistant steel C	Property class	50	[kN]	15	21	39
			70 ³⁾	[kN]	20	30	55
		80	[kN]	23	34	63	
	Steel failure with lever arm						
Characteristic bending moment $M_{Rk,s}^0$	Property class	5.8	[Nm]	37	65	167	
		8.8	[Nm]	60	105	266	
	Stainless steel A4	Property class	50	[Nm]	37	65	166
			70	[Nm]	52	92	233
		80	[Nm]	60	105	266	
	High corrosion-resistant steel C	Property class	50	[Nm]	37	65	166
			70 ³⁾	[Nm]	52	92	233
		80	[Nm]	60	105	266	
	Partial safety factor steel failure						
$\gamma_{Ms,V}^{1)}$	Property class	5.8	[-]	1,25			
		8.8	[-]	1,25			
	Stainless steel A4	Property class	50	[-]	2,38		
			70	[-]	1,56		
		80	[-]	1,25			
	High corrosion-resistant steel C	Property class	50	[-]	2,38		
			70 ³⁾	[-]	1,25		
	80	[-]	1,33				
Concrete pryout failure							
Factor in equation (5.7) of Technical Report TR 029 for the design of bonded anchors				k	[-]	2,0	
Partial safety factor				$\gamma_{Mcp}^{1)}$	[-]	1,5 ²⁾	
Concrete edge failure							
See chapter 5.2.3.4 of Technical Report TR 029 for the design of bonded anchors							
Partial safety factor				$\gamma_{Mc}^{1)}$	[-]	1,5 ²⁾	

¹⁾ In absence of other national regulations.

²⁾ The partial safety factor $\gamma = 1,0$ is included.

³⁾ $f_{uk} = 700 \text{ N/mm}^2$; $f_{yk} = 560 \text{ N/mm}^2$

Injection system fischer Powerbond

Characteristic values to shear load

Annex 7

Table 5: Displacement under tension load non-cracked concrete ($h_{ef} = 6d$)¹⁾

Size		M 10	M 12	M 16
Displacement	δ_{NO} [mm/(N/mm ²)]	0,03	0,04	0,05
Displacement	$\delta_{N\infty}$ [mm/(N/mm ²)]	0,05	0,06	0,08

Table 6: Displacement under tension load cracked concrete ($h_{ef} = 6d$)¹⁾

Size		M 10	M 12	M 16
Displacement	δ_{NO} [mm/(N/mm ²)]	0,07	0,09	0,11
Displacement	$\delta_{N\infty}$ [mm/(N/mm ²)]	0,10	0,13	0,17

¹⁾ values $6d < h_{ef} \leq 12d$ can be designed

$$\delta_{NO} = \delta_{NO1} \cdot \frac{h_{ef}}{6d} \quad (\delta_{NO1} \text{ for } h_{ef} = 6d)$$

$$\delta_{N\infty} = \delta_{N\infty1} \cdot \frac{h_{ef}}{6d} \quad (\delta_{N\infty1} \text{ for } h_{ef} = 6d)$$

Table 7: Displacement under shear load

Size		M 10	M 12	M 16
Displacement	δ_{VO} [mm/KN]	0,15	0,12	0,09
Displacement	$\delta_{V\infty}$ [mm/KN]	0,22	0,18	0,14

Calculation of displacement under service load: $\delta_v = \frac{\delta_{VO} \cdot V_{Sd}}{1,4}$
(V_{Sd} = design value of shear load)

Injection system fischer Powerbond

Displacements

Annex 8