



European Technical Approval ETA-12/0259

English translation prepared by DIBt - Original version in German language

Handelsbezeichnung
Trade name

Chemofast Injektionssystem STVK für Mauerwerk
Chemofast Injection system STVK for masonry

Zulassungsinhaber
Holder of approval

CHEMOFAST Anchoring GmbH
Hanns-Martin-Schleyer-Straße 23
47877 Willich
DEUTSCHLAND

Zulassungsgegenstand
und Verwendungszweck
*Generic type and use
of construction product*

Injektionssystem zur Verankerung im Mauerwerk
Injection system for use in masonry

Geltungsdauer:
Validity: vom
from
bis
to

8 August 2012
8 August 2017

Herstellwerk
Manufacturing plant

Chemofast Anchoring GmbH

Diese Zulassung umfasst
This Approval contains

19 Seiten einschließlich 11 Anhänge
19 pages including 11 annexes

I LEGAL BASES AND GENERAL CONDITIONS

- 1 This European technical approval is issued by Deutsches Institut für Bautechnik in accordance with:
 - Council Directive 89/106/EEC of 21 December 1988 on the approximation of laws, regulations and administrative provisions of Member States relating to construction products¹, modified by Council Directive 93/68/EEC² and Regulation (EC) N° 1882/2003 of the European Parliament and of the Council³;
 - *Gesetz über das In-Verkehr-Bringen von und den freien Warenverkehr mit Bauprodukten zur Umsetzung der Richtlinie 89/106/EWG des Rates vom 21. Dezember 1988 zur Angleichung der Rechts- und Verwaltungsvorschriften der Mitgliedstaaten über Bauprodukte und anderer Rechtsakte der Europäischen Gemeinschaften (Bauproduktengesetz - BauPG) vom 28. April 1998⁴, as amended by law of 31 October 2006⁵;*
 - Common Procedural Rules for Requesting, Preparing and the Granting of European technical approvals set out in the Annex to Commission Decision 94/23/EC⁶;
 - Guideline for European technical approval of "Metal Injection Anchors for Use in Masonry", ETAG 029.
- 2 Deutsches Institut für Bautechnik is authorized to check whether the provisions of this European technical approval are met. Checking may take place in the manufacturing plant. Nevertheless, the responsibility for the conformity of the products to the European technical approval and for their fitness for the intended use remains with the holder of the European technical approval.
- 3 This European technical approval is not to be transferred to manufacturers or agents of manufacturers other than those indicated on page 1, or manufacturing plants other than those indicated on page 1 of this European technical approval.
- 4 This European technical approval may be withdrawn by Deutsches Institut für Bautechnik, in particular pursuant to information by the Commission according to Article 5(1) of Council Directive 89/106/EEC.
- 5 Reproduction of this European technical approval including transmission by electronic means shall be in full. However, partial reproduction can be made with the written consent of Deutsches Institut für Bautechnik. In this case partial reproduction has to be designated as such. Texts and drawings of advertising brochures shall not contradict or misuse the European technical approval.
- 6 The European technical approval is issued by the approval body in its official language. This version corresponds fully to the version circulated within EOTA. Translations into other languages have to be designated as such.

¹ Official Journal of the European Communities L 40, 11 February 1989, p. 12
² Official Journal of the European Communities L 220, 30 August 1993, p. 1
³ Official Journal of the European Union L 284, 31 October 2003, p. 25
⁴ *Bundesgesetzblatt Teil I 1998*, p. 812
⁵ *Bundesgesetzblatt Teil I 2006*, p. 2407, 2416
⁶ Official Journal of the European Communities L 17, 20 January 1994, p. 34

II SPECIFIC CONDITIONS OF THE EUROPEAN TECHNICAL APPROVAL

1 Definition of product and intended use

1.1 Definition of the construction product

The Injection system Chemofast STVK is a bonded anchor (injection type) consisting of a mortar cartridge with Chemofast injection mortar STVK, a perforated sleeve and an anchor rod with hexagon nut and washer in the range of M8 to M12. The steel elements are made of zinc coated steel or stainless steel.

The anchor rod is placed into a drilled hole filled with injection mortar and is anchored via the bond between steel element, injection mortar and masonry.

An illustration of the product and intended use is given in Annex 1.

1.2 Intended use

The anchor is intended to be used for anchorages for which requirements for mechanical resistance and stability and safety in use in the sense of the Essential Requirements 1 and 4 of Council Directive 89/106 EEC shall be fulfilled and failure of anchorages made with these products would cause risk to human life and/or lead to considerable economic consequences.

The anchor is to be used only for anchorages subject to static or quasi-static loading in solid masonry (use category b) or hollow or perforated masonry (use category c) according to Annex 7. The mortar strength class of the masonry has to be M 2,5 according to EN 998-2:2010 at minimum.

The anchor may be used in the following service temperature ranges:

Temperature range I:	-40 °C to +40 °C	(max long term temperature +24 °C and max short term temperature +40 °C)
Temperature range II:	-40 °C to +80 °C	(max long term temperature +50 °C and max short term temperature +80 °C)

The anchor may be installed in dry or wet structures.

Regarding the injection mortar the anchor may be used in dry and wet structures (category w/w). Regarding the steel elements of the anchor following use conditions applies:

Steel elements made of zinc coated steel:

The steel elements made of electroplated or hot-dipped galvanised steel may only be used in structures subject to dry internal conditions.

Steel elements made of stainless steel A4:

The steel element made of stainless steel may be used in structures subject to dry internal conditions and also in structures subject to external atmospheric exposure (including industrial and marine environment), or exposure in permanently damp internal conditions, if no particular aggressive conditions exist. Such particular aggressive conditions are e.g. permanent, alternating immersion in seawater or the splash zone of seawater, chloride atmosphere of indoor swimming pools or atmosphere with extreme chemical pollution (e.g. in desulphurization plants or road tunnels where de-icing materials are used).

The provisions made in this European technical approval are based on an assumed working life of the anchor of 50 years. The indications given on the working life cannot be interpreted as a guarantee given by the producer, but are to be regarded only as a means for choosing the right products in relation to the expected economically reasonable working life of the works.

2 Characteristics of the product and methods of verification

2.1 Characteristics of product

The anchor corresponds to the drawings and provisions given in the annexes. The characteristic material values, dimensions and tolerances of the anchor not indicated in annexes shall correspond to the respective values laid down in the technical documentation⁷ of this European technical approval.

The characteristic anchor values for the design of anchorages are given in Annex 9 to Annex 11. The anchor is assumed to satisfy the requirements for class A1 of the characteristic reaction to fire.

Regarding resistance to fire no performance is determined.

2.2 Methods of verification

The assessment of fitness of the anchor for the intended use in relation to the requirements for mechanical resistance and stability and safety in use in the sense of the Essential Requirements 1 and 4 has been made in accordance with the "Guideline for European technical approval of Metal Injection Anchors for Use in Masonry", ETAG 029, based on the Use Categories b and c in respect of the base material and Category w/w in respect of installation and use.

In addition to the specific clauses relating to dangerous substances contained in this European technical approval, there may be other requirements applicable to the products falling within its scope (e.g. transposed European legislation and national laws, regulations and administrative provisions). In order to meet the provisions of the Construction Products Directive, these requirements need also to be complied with, when and where they apply.

3 Evaluation and attestation of conformity and CE marking

3.1 System of attestation of conformity

According to the Decision 97/177/EC of the European Commission⁸ System 1 of the attestation of conformity applies.

This system of attestation of conformity is defined as follows:

System 1: Certification of the conformity of the product by an approved certification body on the basis of:

- (a) Tasks for the manufacturer:
 - (1) factory production control;
 - (2) further testing of samples taken at the factory by the manufacturer in accordance with a prescribed test plan;

⁷ The technical documentation of this European technical approval is deposited at the Deutsches Institut für Bautechnik and, as far as relevant for the tasks of the approved bodies involved in the attestation of conformity procedure, is handed over to the approved bodies.

⁸ Official Journal of the European Communities L 073 of 14.03.1997

- (b) Tasks for the approved body:
- (3) initial type-testing of the product;
 - (4) initial inspection of factory and of factory production control;
 - (5) continuous surveillance, assessment and approval of factory production control.

Note: Approved bodies are also referred to as "notified bodies".

3.2 Responsibilities

3.2.1 Tasks for the manufacturer

3.2.1.1 Factory production control

The manufacturer shall exercise permanent internal control of production. All the elements, requirements and provisions adopted by the manufacturer shall be documented in a systematic manner in the form of written policies and procedures, including records of results performed. This production control system shall insure that the product is in conformity with this European technical approval.

The manufacturer may only use initial/raw/constituent materials stated in the technical documentation of this European technical approval.

The factory production control shall be in accordance with the control plan⁹ which is part of the technical documentation of this European technical approval. The control plan is laid down in the context of the factory production control system operated by the manufacturer and deposited at Deutsches Institut für Bautechnik. The results of factory production control shall be recorded and evaluated in accordance with the provisions of the control plan.

3.2.1.2 Other tasks for the manufacturer

The manufacturer shall, on the basis of a contract, involve a body which is approved for the tasks referred to in section 3.1 in the field of anchors in order to undertake the actions laid down in section 3.2.2 For this purpose, the control plan referred to in sections 3.2.1.1 and 3.2.2 shall be handed over by the manufacturer to the approved body involved.

The manufacturer shall make a declaration of conformity, stating that the construction product is in conformity with the provisions of this European technical approval.

3.2.2 Tasks for the approved bodies

The approved body shall perform the

- initial type-testing of the product,
- initial inspection of factory and of factory production control,
- continuous surveillance, assessment and approval of factory production control,

in accordance with the provisions laid down in the control plan.

The approved body shall retain the essential points of its actions referred to above and state the results obtained and conclusions drawn in a written report.

The approved certification body involved by the manufacturer shall issue an EC certificate of conformity of the product stating the conformity with the provisions of this European technical approval.

In cases where the provisions of the European technical approval and its control plan are no longer fulfilled the certification body shall withdraw the certificate of conformity and inform Deutsches Institut für Bautechnik without delay.

⁹

The control plan is a confidential part of the European technical approval and only handed over to the approved body involved in the procedure of attestation of conformity. See section 3.2.2.

3.3 CE marking

The CE marking shall be affixed on each packaging of the anchor. The letters "CE" shall be followed by the identification number of the approved certification body, where relevant, and be accompanied by the following additional information:

- the name and address of the producer (legal entity responsible for the manufacture),
- the last two digits of the year in which the CE marking was affixed,
- the number of the EC certificate of conformity for the product,
- the number of the European technical approval,
- ETAG 029,
- use category (b, c, and w/w) and
- size.

4 Assumptions under which the fitness of the product for the intended use was favourably assessed

4.1 Manufacturing

The European technical approval is issued for the product on the basis of agreed data/information, deposited with Deutsches Institut für Bautechnik, which identifies the product that has been assessed and judged. Changes to the product or production process, which could result in this deposited data/information being incorrect, should be notified to Deutsches Institut für Bautechnik before the changes are introduced.

Deutsches Institut für Bautechnik will decide whether or not such changes affect the approval and consequently the validity of the CE marking on the basis of the approval and if so whether further assessment or alterations to the approval shall be necessary.

4.2 Design of anchorages

The fitness of the anchor for the intended use is given under the following conditions:

The anchorages are designed in accordance with the ETAG 029, Annex C¹⁰, Design method A under the responsibility of an engineer experienced in anchorages and masonry work.

Verifiable calculation notes and drawings are prepared taking account the relevant masonry in the region of the anchorage (nature and strength of the base materials), the loads to be transmitted and their transmission to the supports of the structure. The position of the anchor is indicated on the design drawings.

The characteristic resistances are only valid for kind of bricks according to Annex 7. The characteristic resistance for use in solid masonry are also valid for larger brick sizes and larger compressive strength of the masonry unit.

It is to ensure that the use category applies and that the characteristic values of the base material in which the anchor is to be placed, is identical with the values, which the characteristic loads apply for.

For other bricks in solid masonry and in hollow or perforated masonry, the characteristic resistance of the anchor may be determined by job site tests according to ETAG 029, Annex B¹¹ under consideration of the β -factor according to Annex 10, Table 10.

¹⁰ The Guideline ETAG 029, "Metal Injection Anchors for Use in Masonry, Annex C: Design Methods for Anchorages" is published in English on EOTA website www.eota.eu.

¹¹ The Guideline ETAG 029, "Metal Injection Anchors for Use in Masonry, Annex B: Recommendations for tests to be carried out on construction works" is published in English on EOTA website www.eota.eu.

4.3 Installation

The fitness for use of the anchor can only be assumed if the anchor is installed as follows:

- anchor installation carried out by appropriately qualified personnel and under the supervision of the person responsible for technical matters of the site,
- use of the anchor only as supplied by the manufacturer without exchanging the components of an anchor,
- anchor installation in accordance with the manufacturer's specifications and drawings using the tools indicated in the technical documentation of this European technical approval,
- checks before placing the anchor to ensure that the use category applies,
- commercial standard threaded rods, washers and hexagon nuts may also be used if the following requirements are fulfilled:
 - material, dimensions and mechanical properties of the metal parts according to the specifications given in Annex 3,
 - confirmation of material and mechanical properties of the metal parts by inspection certificate 3.1 according to EN 10204:2004, the documents should be stored,
 - marking of the threaded rod with the envisage embedment depth. This may be done by the manufacturer of the rod or the person on jobsite.
- holes to be drilled perpendicular to the surface of the base material by using a hard-metal tipped hammer drill bit,
- in case of aborted drill hole the drill hole shall be filled with mortar,
- hole cleaning and anchor installation in accordance with manufacturer's installation instructions (Annex 5 and 6),
- keeping the installation parameters (Annex 4),
- marking and keeping the effective anchorage depth,
- keeping edge distance and spacing according to Annex 11 without minus tolerances,
- observing the curing time according to Annex 6, Table 5 until the anchor may be loaded.

5 Indications to the manufacturer

5.1 Manufacturer's responsibilities

It is in the responsibility of the manufacturer to ensure that the information on the specific conditions according to 1 and 2 as well as sections 4.2, 4.3 and 5.2 is given to those who are concerned. This information may be made by reproduction of the respective parts of the European technical approval. In addition all installation data shall be shown clearly on the package and/or on an enclosed instruction sheet, preferably using illustration(s).

The minimum data required are:

- installation parameters according to Annex 4,
- material and property class of metal parts according to Annex 3, Table 1,
- information on the installation procedure, including cleaning of the hole with the cleaning equipments, preferably by means of an illustration,
- exact volume of injection mortar depend on the relevant installation,

European technical approval

ETA-12/0259

English translation prepared by DIBt

Page 8 of 19 | 8 August 2012

- storage temperature of anchor components, minimum and maximum temperature of the base material, processing time (open time) of the mortar and curing time until the anchor may be loaded according to Annex 6,
- identification of the manufacturing batch.

All data shall be presented in a clear and explicit form.

5.2 Recommendations regarding packaging, transport and storage

The injection cartridges shall be protected against sun radiation and shall be stored according to the manufacture's installation instructions in dry condition at temperatures of at least +5 °C to not more than +25 °C. Mortar cartridges with expired shelf life must no longer be used.

Georg Feistel
Head of Department

beglaubigt:
Wittstock

Installation in hollow brick; threaded rod with sleeve

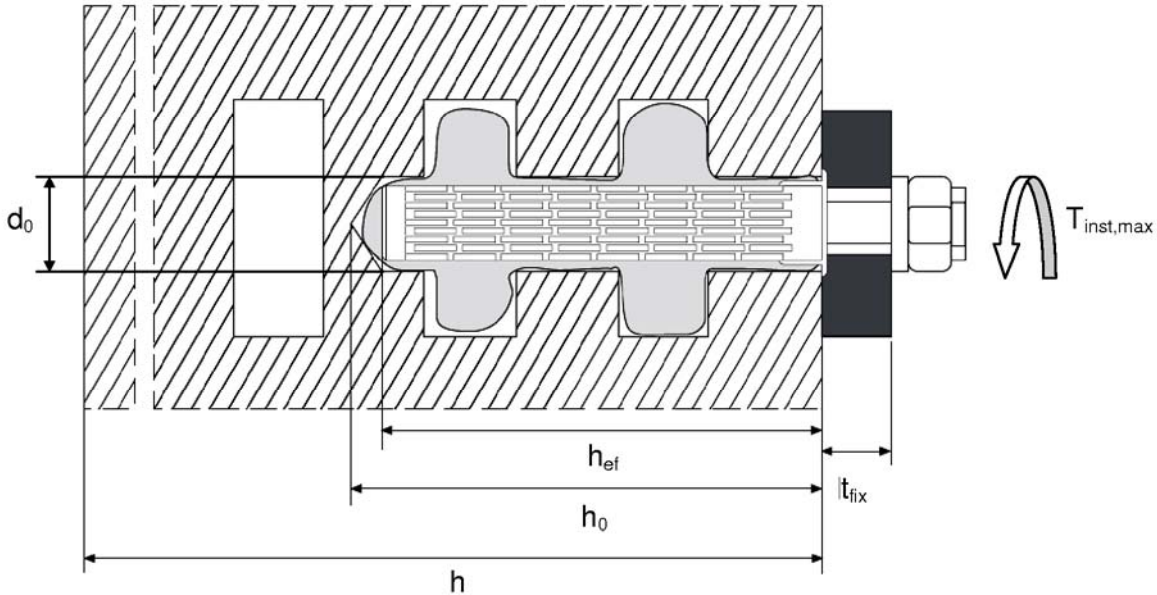

Installation in solid brick; threaded rod with or without sleeve

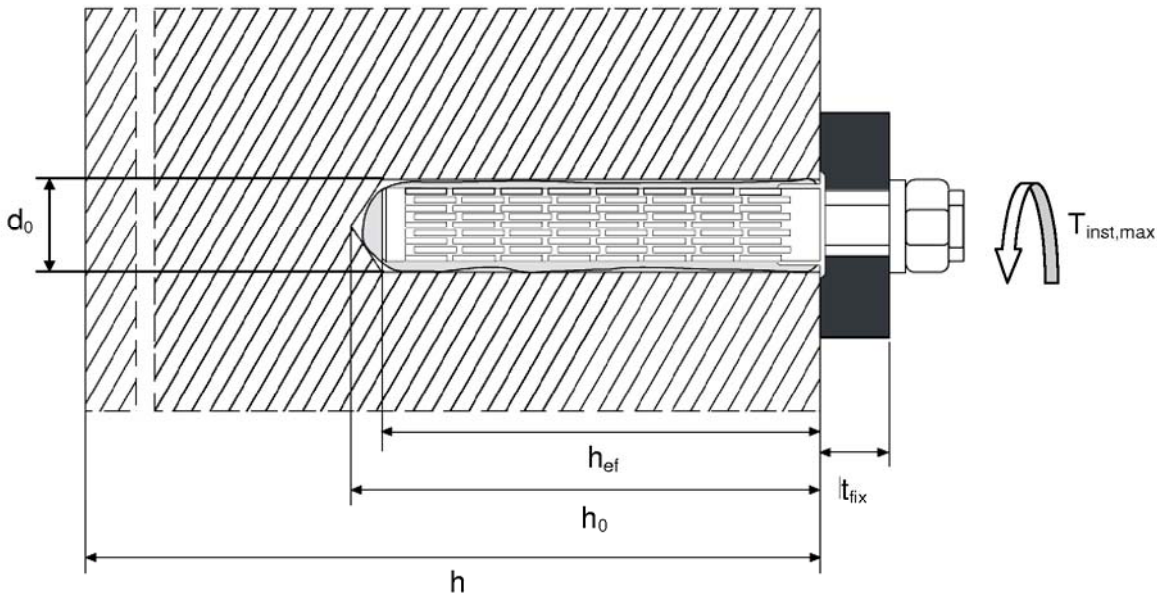

h_{ef} = effective setting depth
 h_0 = bore hole depth
 t_{fix} = thickness of fixure

d_0 = bore hole diameter
 T_{inst} = torque moment

Chemofast Injection system STVK for masonry

Product and intended use

Annex 1

Cartridge: Chemofast STVK/ALVK

150 ml, 280 ml, 300 ml, 330 ml, 380 ml, 410 ml and 420 ml cartridge (Type: coaxial)

Sealing/Screw cap

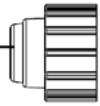

Imprint: Chemofast STVK/ALVK,
processing notes, charge-code, shelf life, hazard-
code, curing- and processing time (depending on the
temperature), with as well as without travel scale

235 ml, 345 ml and 825 ml cartridge (Type: "side-by-side")

Sealing/Screw cap

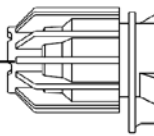

Imprint: Chemofast STVK/ALVK,
processing notes, charge-code, shelf life, hazard-
code, curing- and processing time (depending on the
temperature), with as well as without travel scale

165 ml and 300 ml cartridge (Type: "foil tube")

Sealing/Screw cap

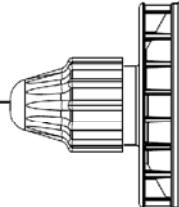

Imprint: Chemofast STVK/ALVK,
processing notes, charge-code, shelf life, hazard-code,
curing- and processing time (depending on the
temperature), with as well as without travel scale

Static Mixer

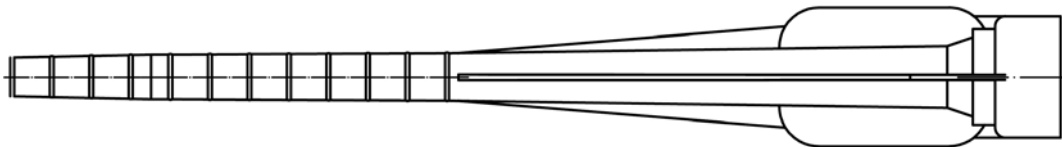

Use category:

Base material: b and c (Solid or hollow masonry)
Installation and use: w / w (Installation and use in dry, wet masonry)

Temperature range:

- 40 °C to +40 °C (max. short term temperature +40 °C and max. long term temperature +24 °C)
- 40 °C to +80 °C (max. short term temperature +80 °C and max. long term temperature +50 °C)

Chemofast Injection system STVK for masonry

Product (Injection system)
Use category

Annex 2

Threaded rod M8, M8 IG, M10, M12*

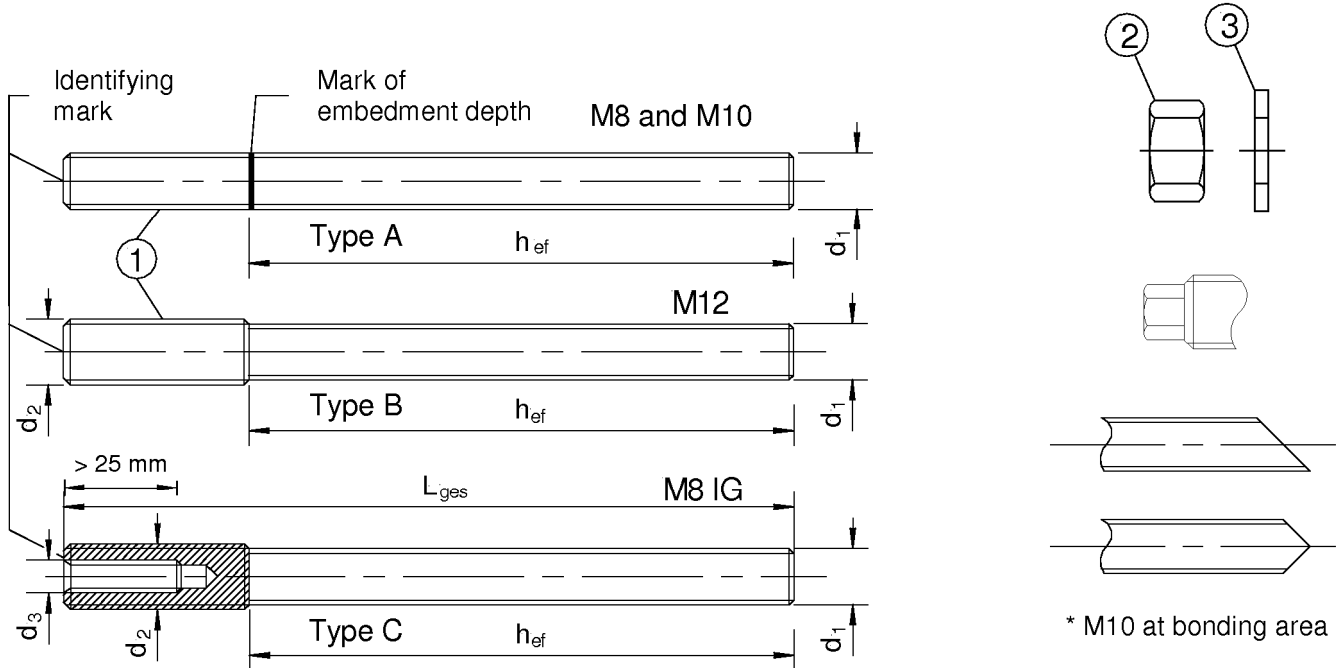

With mark (Type A, B, C):

- Identifying mark: CVM; thread size: M
- additional with stainless steel: A4
- e.g. CVM M8 A4

Commercial standard rod (only Type A) with:

- Materials, dimensions and mechanical properties acc. to Table 1
- Inspection certificate 3.1 acc. to EN 10204:2004
- Marking of embedding depth

Table 1: Materials

Part	Designation	Material
Steel, zinc plated $\geq 5\ \mu\text{m}$ acc. to EN ISO 4042 or Steel, hot-dip galvanised $\geq 40\ \mu\text{m}$ acc. to EN ISO 1461 and EN ISO 10684		
1	Anchor rod	Steel, EN 10087 or EN 10263 Property class 5.8 EN ISO 898-1:1999
2	Hexagon nut, EN ISO 4032	Property class 5 (for class 5.8 rod) EN 20898-2,
3	Washer, EN ISO 887, EN ISO 7089, EN ISO 7093, or EN ISO 7094	Steel, zinc plated or hot-dip galvanised
Stainless steel		
1	Anchor rod	Material 1.4401 / 1.4404 / 1.4571, EN 10088-1:2005, Property class 70 EN ISO 3506
2	Hexagon nut, EN ISO 4032	Material 1.4401 / 1.4404 / 1.4571 EN 10088, Property class 70 (for class 70 rod) EN ISO 3506
3	Washer, EN ISO 887, EN ISO 7089, EN ISO 7093, or EN ISO 7094	Material 1.4401, 1.4404 or 1.4571, EN 10088

Chemofast Injection system STVK for masonry

Threaded rod
Materials

Annex 3

Sleeve (Plastic) SH 13 / 100 and SH 15 / 100

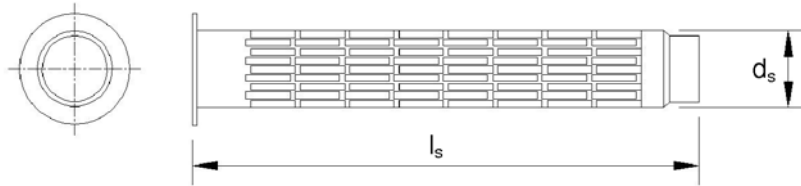

Table 2: Sizes threaded rod and sleeve (mm)

Threaded rods							Sleeves		
Size	d ₁	d ₂	d ₃	h _{ef}	L _{min}	L _{max}	Size	d _s	l _s
[mm]								[mm]	[mm]
M8	8	8	-	80	100	500	SH13/100	13	100
M8 IG	10	12	8	90	110	500	SH15/100	15	100
M10	10	10	-	90	110	500	SH15/100	15	100
M12*	10	12	-	90	110	500	SH15/100	15	100

Brush

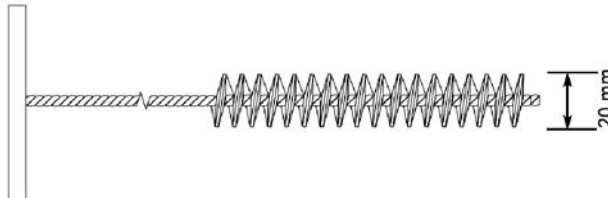

Table 3: Installation parameters in solid masonry (without sleeve)

Threaded rod			M8	M8 IG	M10	M12
Nominal drill hole diameter	d ₀	[mm]	10	12	12	12
Embedment depth	h _{ef}	[mm]	80	90	90	90
Bore hole depth	h ₀	[mm]	85	95	95	95
Diameter of clearance hole in the fixture	d _f ≤	[mm]	9	14	12	14
Diameter of nylon brush	d _b ≥	[mm]	20			
Torque moment	T _{inst}	[Nm]	2			

Table 4: Installation parameters in solid and hollow masonry (with sleeve)

Threaded rod			M8	M8 IG	M10	M12
Sleeve			SH 13x100	SH 15x100	SH 15x100	SH 15x100
Nominal drill hole diameter	d ₀	[mm]	14	16	16	16
Embedment depth sleeve	h _{nom}	[mm]	100	100	100	100
Embedment depth rod	h _{ef}	[mm]	80	90	90	90
Bore hole depth	h ₀	[mm]	105	105	105	105
Diameter of clearance hole in the fixture	d _f ≤	[mm]	9	14	12	14
Diameter of nylon brush	d _b ≥	[mm]	20			
Torque moment	T _{inst}	[Nm]	2			

Chemofast Injection system STVK for masonry

Sleeve
Brush
Installation parameters

Annex 4

Installation instructions

Preparation of cartridge

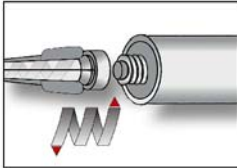

1. Remove the cap and attach the supplied static-mixing nozzle to the cartridge and load the cartridge into the correct dispensing tool. Cut off the foil tube clip before use. For every working interruption longer than the recommended working time (Table 5) as well as for new cartridges, a new static-mixer shall be used.

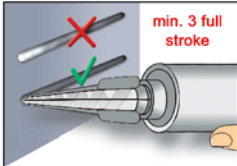

2. Place in the cartridge to an appropriate dispenser tool. Prior to dispensing into the anchor hole, squeeze out separately a minimum of three full strokes and discard non-uniformly mixed adhesive components until the mortar shows a consistent grey colour.

Installation in solid masonry (without sleeve)

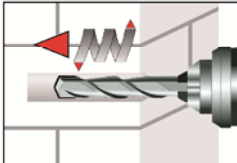

3. Drill a hole, by rotary drill mode, into the base material, with nominal drill hole diameter and bore hole depth acc. to the size and embedment depth required by the selected anchor.

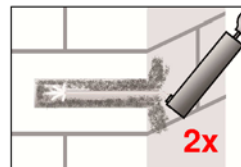
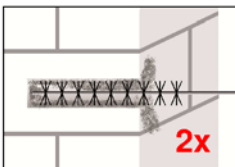
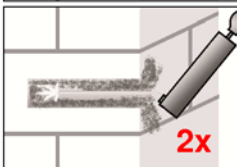

4. Blow from the bottom of the bore hole two times. Brush the hole clean two times, and finally blow out the hole again two times.

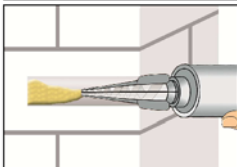

5. Starting from the bottom or back of the cleaned anchor hole fill the hole up to min two-thirds with adhesive. Slowly withdraw the static mixing nozzle as the hole fills to avoid creating air pockets. Observe the gel-/ working times given in Table 5.

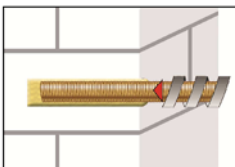
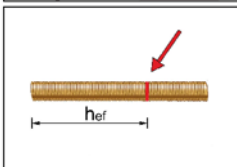

6. The position of the embedment depth shall be marked on the threaded rod. Push the threaded rod into the anchor hole while turning slightly to ensure positive distribution of the adhesive until the embedment depth is reached. The anchor should be free of dirt, grease, oil or other foreign material.

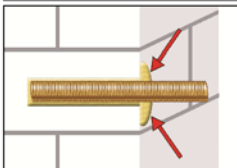

7. Be sure that the annular gap is fully filled with mortar. If no excess mortar is visible at the top of the hole, the application has to be renewed.

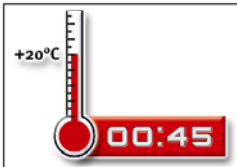

8. Allow the adhesive to cure to the specified curing time prior to applying any load or torque. Do not move or load the anchor until it is fully cured (attend Table 5).

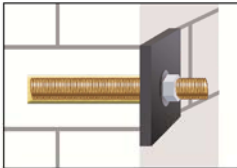

9. After full curing, the fixture can be installed with the max. torque (Table 3 or 4) by using a calibrated torque wrench.

Chemofast Injection system STVK for masonry

Installation instruction (solid brick)

Annex 5

Installation in solid and hollow masonry (with sleeve)

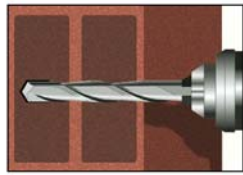

3. Drill a hole, by rotary drill mode, into the base material, with nominal drill hole diameter and bore hole depth acc. to the size and embedment depth required by the selected anchor.

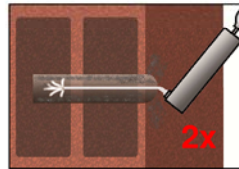
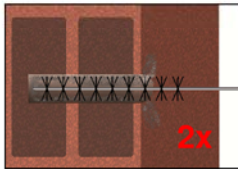
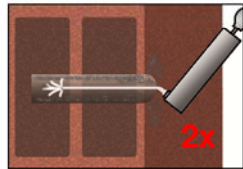

4. Blow from the bottom of the bore hole two times. Brush the hole clean two times, and finally blow out the hole again two times.

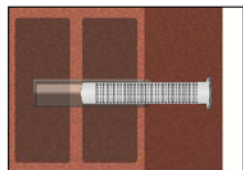

5. Insert the perforated sleeve into the bore hole. Make sure that the sleeve fits well into the hole. Never cut the sleeve! Only use sleeves that have the right length.

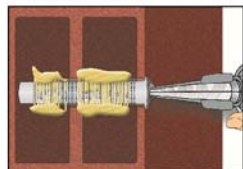

6. Starting from the bottom or back fill the sleeve completely with adhesive. For quantity of mortar attend cartridge label. Observe the gel-/ working times given in Table 5.

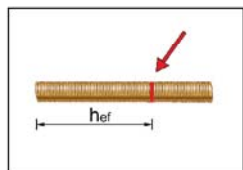

7. The position of the embedment depth shall be marked on the threaded rod. Push the threaded rod into the anchor hole while turning slightly to ensure positive distribution of the adhesive until the embedment depth is reached. The anchor should be free of dirt, grease, oil or other foreign material.

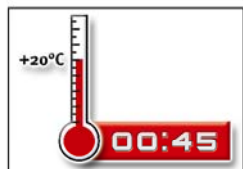

8. Allow the adhesive to cure to the specified curing time prior to applying any load or torque. Do not move or load the anchor until it is fully cured (attend Table 5).

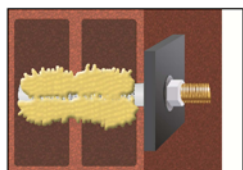

9. After full curing, the fixture can be installed with the max. torque (Table 4) by using a calibrated torque wrench.

Table 5: Minimum curing time

Base material temperature	Gelling- / working time	Minimum curing time in dry base material ¹⁾
+ 5 °C to +9 °C	25 min	2 h
+ 10 °C to +19 °C	15 min	80 min
+ 20 °C to +29 °C	6 min	45 min
+ 30 °C to +34 °C	4 min	25 min
+ 35 °C to +40 °C	2 min	20 min

1) In wet base material the curing time **must** be doubled

Chemofast Injection system STVK for masonry

Installation instruction (hollow brick)
Gelling and curing times

Annex 6

Types of brick and dimensions

Brick No. 1

Calcium silicate
masonry
KSV – NF
acc. to EN 771-1
 $\rho \geq 1,8$ [kg/dm³]
 $f_b \geq 8$ [N/mm²]

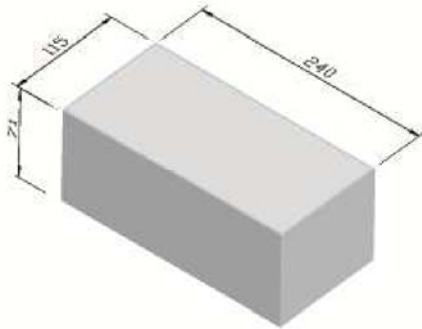

Brick No. 2

Clay masonry
Mz – NF
acc. to EN 771-1
 $\rho \geq 1,8$ [kg/dm³]
 $f_b \geq 12$ [N/mm²]

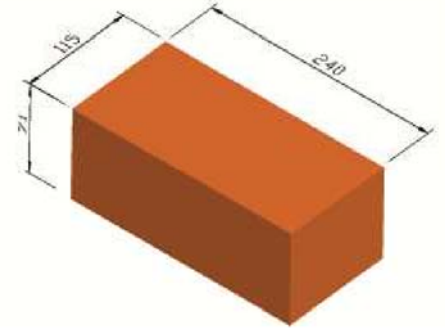

Brick No. 3

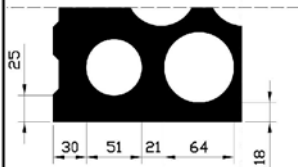
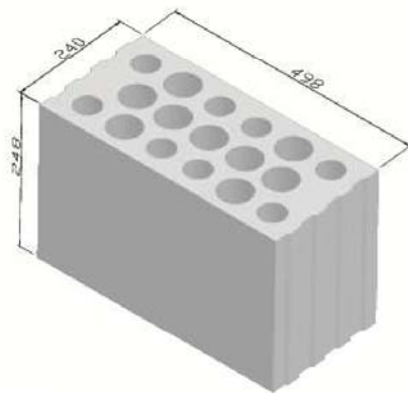

Calcium silicate masonry
KSL-R-12-1,2-16DF
acc. to EN 771-1
 $\rho \geq 1,2$ [kg/dm³]
 $f_b \geq 12$ [N/mm²]

Brick No. 4

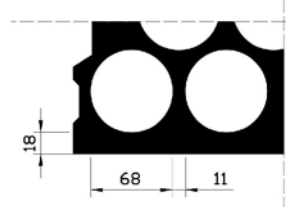
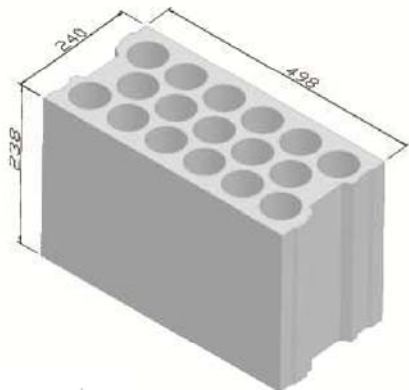

Calcium silicate masonry
KSL-12-1,2-16DF
acc. to EN 771-2
 $\rho \geq 1,2$ [kg/dm³]
 $f_b \geq 12$ [N/mm²]

Brick No. 5

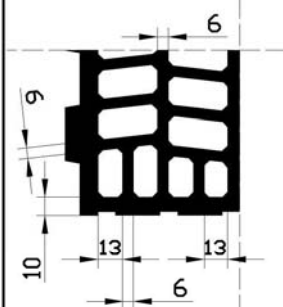
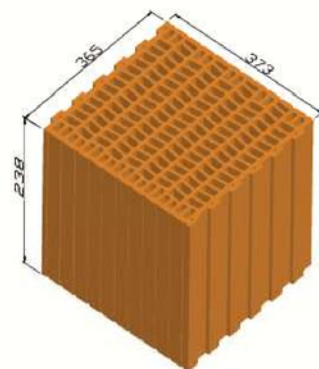

Clay masonry
Hz-12-0,8-xxDF
acc. to Z-17.1-383
 $\rho \geq 0,8$ [kg/dm³]
 $f_b \geq 12$ [N/mm²]

Brick No. 6

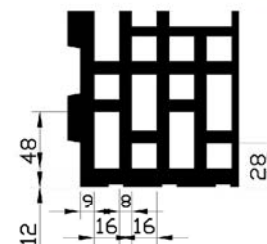
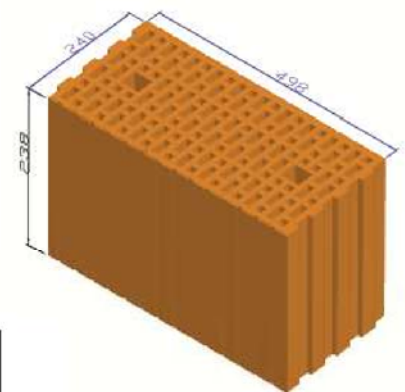



Clay masonry
Hz-12-0,9-16DF N+F
acc. to EN 771-1
 $\rho \geq 0,9$ [kg/dm³]
 $f_b \geq 12$ [N/mm²]

Chemofast Injection system STVK for masonry

Types of brick and dimensions

Annex 7

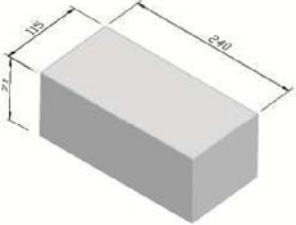
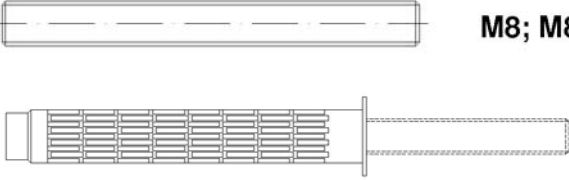
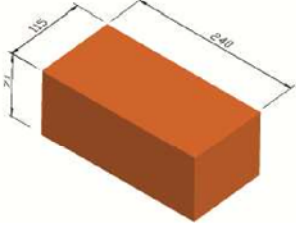
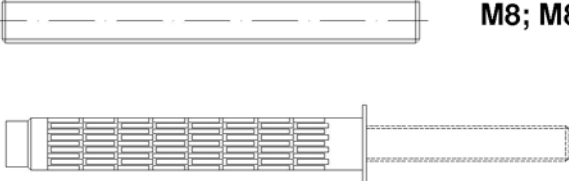
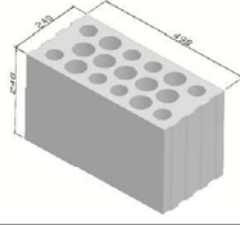
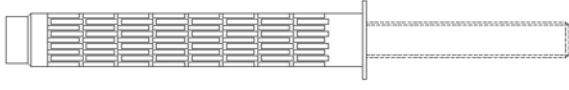
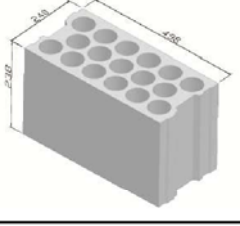
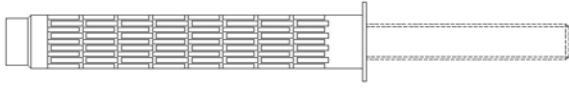
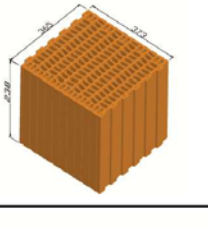
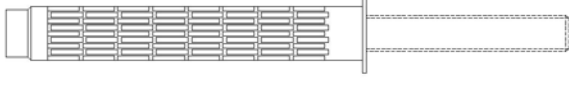
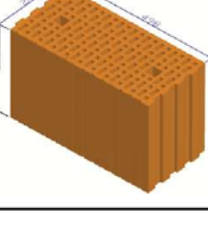
Table 6: Allocation of anchor rods¹⁾, sleeves¹⁾ and bricks

Bricks	Valid anchor rods and sleeves	* M10 at bonding area
 <p style="text-align: right;">No 1</p>		<p>M8; M8IG; M10; M12*</p> <p>SH 13x100 SH 15x100</p>
 <p style="text-align: right;">No 2</p>		<p>M8; M8IG; M10; M12*</p> <p>SH 13x100 SH 15x100</p>
 <p style="text-align: right;">No 3</p>		<p>SH 13x100</p>
 <p style="text-align: right;">No 4</p>		<p>SH 13x100 SH 15x100</p>
 <p style="text-align: right;">No 5</p>		<p>SH 13x100 SH 15x100</p>
 <p style="text-align: right;">No 6</p>		<p>SH 13x100</p>

1) Other combination can be use after job side test acc. to ETAG 029, Annex B.
The β -factors for this job side test are given in Table 10

<p>Chemofast Injection system STVK for masonry</p>	<p style="text-align: center;">Annex 8</p>
<p>Allocation of anchor rods, sleeves and bricks</p>	

Table 7: Characteristic values for tension and shear loads

Brick No.	Density ρ [kg/dm ³] Com- pressive strength f_b [N/mm ²]	Sleeve	Anchor size	Effective Embed- ment depth h_{ef} [mm]	Characteristic resistance							
					Use category							
					dry / dry ⁵⁾				wet / wet ^{5,6)}			
					24 °C/40 °C ⁷⁾		50 °C/80 °C ⁷⁾		24 °C/40 °C ⁷⁾		50 °C/80 °C ⁷⁾	
$N_{Rk}^{1)}$		$V_{Rk}^{2,3)}$		$N_{Rk}^{1)}$		$V_{Rk}^{2,3)}$		$N_{Rk}^{1)}$		$V_{Rk}^{2,3)}$		
[kN]		[kN]		[kN]		[kN]		[kN]		[kN]		
1	$\rho \geq 1,8$ $f_b \geq 8$	without	M8	80	4,0	4,0	3,0	3,0	3,0	3,0	2,5	2,5
		without	M8 IG; M10; M12	90	5,0	5,0	4,5	4,5	4,0	4,0	3,5	3,5
		SH 13x100	M8	80	5,0	5,0	4,5	4,5	4,5	4,5	3,5	3,5
		SH 15x100	M8 IG; M10; M12	90	7,0	7,0	6,0	6,0	5,0	5,0	4,5	4,5
2	$\rho \geq 1,8$ $f_b \geq 12$	without	M8	80	4,0	4,0	3,0	3,0	3,5	3,5	3,0	3,0
		without	M8 IG; M10; M12	90	5,0	5,0	4,5	4,5	5,0	5,0	4,0	4,0
		SH 13x100	M8	80	3,5	3,5	3,0	3,0	3,5	3,5	2,5	2,5
		SH 15x100	M8 IG; M10; M12	90	4,5	4,5	3,5	3,5	4,5	4,5	3,5	3,5
3	$\rho \geq 1,2$ $f_b \geq 12$	SH 13x100	M8	80	3,5	2,5	3,5	2,5	3,0	2,0	3,0	2,0
4	$\rho \geq 1,2$ $f_b \geq 12$	SH 13x100	M8	80	2,5	2,0	2,5	2,0	2,0	1,5	2,0	1,5
		SH 15x100	M8 IG; M10; M12	90	3,0	2,5	3,0	2,5	2,0	2,0	2,0	2,0
5	$\rho \geq 0,8$ $f_b \geq 12$	SH 13x100	M8	80	2,0	2,0	2,0	2,0	2,0	2,0	2,0	2,0
		SH 15x100	M8 IG; M10; M12	90	2,0	2,5	2,0	2,5	2,0	2,5	2,0	2,5
6	$\rho \geq 0,9$ $f_b \geq 12$	SH 13x100	M8	80	3,0	2,0	3,0	2,0	2,5	2,0	2,5	2,0
Partial safety factor γ_M					2,5 ⁴⁾							

- 1) For design according to ETAG 029, Annex C: $N_{Rk} = N_{Rk,p} = N_{Rk,b} = N_{Rk,pb} = N_{Rk,s}$
- 2) For design according to ETAG 029, Annex C: $V_{Rk} = V_{Rk,b} = V_{Rk,s}$
- 3) hollow masonry: $V_{Rk,c} = V_{Rk}$; solid masonry: $V_{Rk,c}$ according to ETAG 029, Annex C
- 4) In absence of national regulations
- 5) Installation / use
- 6) Includes also wet / dry
- 7) Long term temperature / short term temperature

Chemofast Injection system STVK for masonry

Characteristic tension load and shear load values

Annex 9

Table 8: Characteristic values bending moments

			M8	M8 IG ²⁾	M10	M12 ²⁾
Characteristic bending moment, Steel, property class 5.8	$M_{Rk,s}$	[Nm]	19	37	37	37
Partial safety factor	$\gamma_{Ms,v}$ ¹⁾		1,25			
Characteristic bending moment, Stainless steel A4, property class 70	$M_{Rk,s}$	[Nm]	26	52	52	52
Partial safety factor	$\gamma_{Ms,v}$ ¹⁾		1,56			

¹⁾ If no other national regulations exist

²⁾ M10 at bonding area

Table 9: Displacement under shear and tension load

Brick-No.	N [kN]	δ_{N0} [mm]	$\delta_{N\infty}$ [mm]	V [kN]	δ_{V0} [mm]	$\delta_{V\infty}$ [mm]
1	$\frac{N_{Rk}}{1,4 \times \gamma_M}$	0,1	0,2	$\frac{V_{Rk}}{1,4 \times \gamma_M}$	$\frac{V_{Rk} \text{ [kN]}}{2,0 \text{ [kN/mm]}}$	$1,5 \delta_{V0}$
2					0,7	1,1
3						
4						
5						
6						

Table 10: β -factors for job side tests according to ETAG 029, Annex B

Brick-No.	Installation & use	β -factor	
		24 °C / 40 °C	50 °C / 80 °C
1-2	d/d	0,66	0,53
3-6		0,92	
1	w/w (incl. w/d)	0,53	0,42
2		0,61	0,49
3		0,74	
4		0,74	
5		0,86	
6		0,86	

Chemofast Injection system STVK for masonry

Characteristic values bending moments
Displacement under shear and tension load
 β -factors for job side tests

Annex 10

Table 11: Edge distances and spacings

Brick No.	Anchor size											
	M8			M8 IG ¹⁾			M10			M12 ¹⁾		
	C _{min} [mm]	S _{min} [mm]	S _{cr} [mm]	C _{min} [mm]	S _{min} [mm]	S _{cr} [mm]	C _{min} [mm]	S _{min} [mm]	S _{cr} [mm]	C _{min} [mm]	S _{min} [mm]	S _{cr} [mm]
1	50	50	160	50	50	200	50	50	200	50	50	200
2	50	50	160	50	50	200	50	50	200	50	50	200
3	100	100	498	100	100	498	100	100	498	100	100	498
4	100	100	498	100	100	498	100	100	498	100	100	498
5	100	100	373	100	100	373	100	100	373	100	100	373
6	100	100	498	100	100	498	100	100	498	100	100	498

C_{cr} = C_{min}

¹⁾ M10 at bonding area

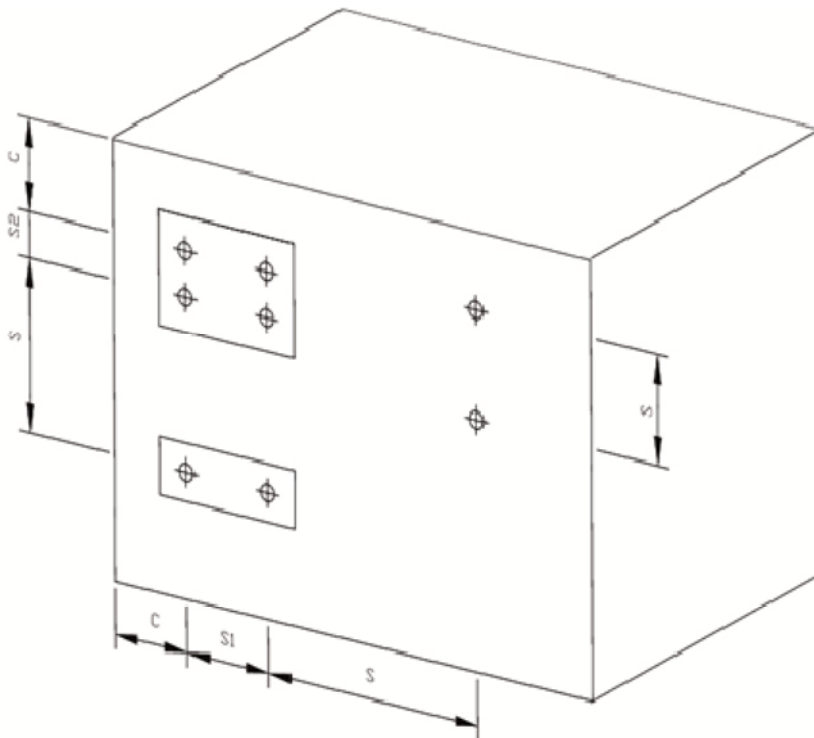

Chemofast Injection system STVK for masonry

Edge distances and spacings

Annex 11