



## European Technical Approval ETA-08/0112

English translation prepared by DIBt - Original version in German language

Handelsbezeichnung  
*Trade name*

EVALON

Zulassungsinhaber  
*Holder of approval*

alwitra GmbH & Co. Klaus Göbel  
Am Forst 1  
54296 Trier  
DEUTSCHLAND

Zulassungsgegenstand  
und Verwendungszweck  
*Generic type and use  
of construction product*

Mechanisch befestigtes Dachabdichtungssystem

*System of mechanically fastened roof waterproofing membranes*

Geltungsdauer:  
*Validity:*

vom  
*from*  
bis  
*to*  
verlängert  
*extended*  
vom  
*from*  
bis  
*to*

12 August 2011

6 May 2013

7 May 2013

7 May 2018

Herstellwerk  
*Manufacturing plant*

CTW Chemotechnisches Werk GmbH & Co. Hermeskeil KG  
Gewerbegebiet Grafenwald  
54411 Hermeskeil  
DEUTSCHLAND

Diese Zulassung umfasst  
*This Approval contains*

30 Seiten einschließlich 18 Anhänge  
*30 pages including 18 annexes*

## I LEGAL BASES AND GENERAL CONDITIONS

- 1 This European technical approval is issued by Deutsches Institut für Bautechnik in accordance with:
  - Council Directive 89/106/EEC of 21 December 1988 on the approximation of laws, regulations and administrative provisions of Member States relating to construction products<sup>1</sup>, modified by Council Directive 93/68/EEC<sup>2</sup> and Regulation (EC) N° 1882/2003 of the European Parliament and of the Council<sup>3</sup>;
  - *Gesetz über das In-Verkehr-Bringen von und den freien Warenverkehr mit Bauprodukten zur Umsetzung der Richtlinie 89/106/EWG des Rates vom 21. Dezember 1988 zur Angleichung der Rechts- und Verwaltungsvorschriften der Mitgliedstaaten über Bauprodukte und anderer Rechtsakte der Europäischen Gemeinschaften (Bauproduktengesetz - BauPG) vom 28. April 1998<sup>4</sup>, as amended by Article 2 of the law of 8 November 2011<sup>5</sup>;*
  - Common Procedural Rules for Requesting, Preparing and the Granting of European technical approvals set out in the Annex to Commission Decision 94/23/EC<sup>6</sup>;
  - Guideline for European technical approval of "Mechanically fastened flexible roof waterproofing membranes", ETAG 006.
- 2 Deutsches Institut für Bautechnik is authorized to check whether the provisions of this European technical approval are met. Checking may take place in the manufacturing plant. Nevertheless, the responsibility for the conformity of the products to the European technical approval and for their fitness for the intended use remains with the holder of the European technical approval.
- 3 This European technical approval is not to be transferred to manufacturers or agents of manufacturers other than those indicated on page 1, or manufacturing plants other than those indicated on page 1 of this European technical approval.
- 4 This European technical approval may be withdrawn by Deutsches Institut für Bautechnik, in particular pursuant to information by the Commission according to Article 5(1) of Council Directive 89/106/EEC.
- 5 Reproduction of this European technical approval including transmission by electronic means shall be in full. However, partial reproduction can be made with the written consent of Deutsches Institut für Bautechnik. In this case partial reproduction has to be designated as such. Texts and drawings of advertising brochures shall not contradict or misuse the European technical approval.
- 6 The European technical approval is issued by the approval body in its official language. This version corresponds fully to the version circulated within EOTA. Translations into other languages have to be designated as such.

<sup>1</sup> Official Journal of the European Communities L 40, 11 February 1989, p. 12  
<sup>2</sup> Official Journal of the European Communities L 220, 30 August 1993, p. 1  
<sup>3</sup> Official Journal of the European Union L 284, 31 October 2003, p. 25  
<sup>4</sup> *Bundesgesetzblatt Teil I 1998*, p. 812  
<sup>5</sup> *Bundesgesetzblatt Teil I 2011*, p. 2178  
<sup>6</sup> Official Journal of the European Communities L 17, 20 January 1994, p. 34

## II SPECIFIC CONDITIONS OF THE EUROPEAN TECHNICAL APPROVAL

### 1 Definition of product and intended use

#### 1.1 Definition of the construction product

The mechanical fastened flexible roof waterproofing kit EVALON consists of different flexible waterproofing sheets on the basis of Ethylen-Vinylacetat-Terpolymer (EVA) / Poly-Vinyl-Chlorine (PVC), clad with polyester fleece or clutch based on non-woven glass fibre with synthetic clutch and sets of fasteners and washers.

The waterproofing sheets are compatible with bitumen.

The kit with the components waterproofing sheet, fastener and washer can be assembled of for creating the mechanically fastened one layer roof waterproofing system. Cover stripes and cover pieces are cut from sheet material.

The insulation material is not a component of the kit.

The system build-up is given in Annex 1

#### 1.1.1 Waterproofing sheet

The waterproofing sheets EVALON V, EVALON GV, EVALON VG and EVALON V Solar are CE-marked according EN 13956.

The waterproofing sheets are delivered in rolls with a maximum length of 25 m meters. The waterproofing sheets are available in various widths. The maximum width is 2.05 meters.

The manufacturers declared value (MDV) of the effective thickness of the waterproofing layer is 1.2, 1.5 or 1.8 mm. The waterproofing layer can be clad with polyester fleece or non-woven glass fibre with synthetic clutch or glass fibre with polyester fleece.

The waterproofing sheet EVALON V Solar consists of the waterproofing sheet EVALON V combined with the photovoltaic modules. The PV modules with different sizes are laminated entire on the surface of the sheet in the factory. The PV-modules are placed on the waterproofing sheet in such a way that a circumferential border of sufficient width of 35 cm of the waterproofing sheet is free for overlap welding and fastening. The leading through of the cables are fully sealed with resin and covered by the PV modules<sup>7</sup>. The EVALON V Solar waterproofing sheets are manufactured in 4 different dimensions: length 6 m and 3.36 m; width 1.55 m and 1.05 m. The thickness of the waterproofing layer is 1.8 mm with polyester fleece.

The PV modules fulfil the requirements of the Electromagnetic Compatibility Directive and the Low Voltage Directive. The declaration of conformity of the manufacturer is on hand. The CE-marking comprise the provisions of implementing of all relevant council directives of the European Communities.

The joints overlap of the waterproofing sheet shall be welded with hot air or with solvent with minimum width of 20 mm respectively 30 mm.

The minimum of the joint overlap is 110 mm.

Table 1 gives the general description of the flexible waterproofing sheets. The accompanying mechanical characteristics are stated in the annexes 2, 3 and 4.

<sup>7</sup> The reliability and durability of electric energy production by the PV-modules have not been assessed in the approval procedure and are not covered by the ETA, for the reason that this aspect is not covered by the related guideline ETAG 006.

Table 1: Waterproofing sheets

Membrane	Cladding/Backing layer [g/m <sup>2</sup> ]	Effective thickness of waterproofing layer without backing [mm]	Mass per unit area [g/m <sup>2</sup> ]
EVALON V	polyester fleece approx. 160	1.8	2300 ≤ Fg ≤ 2650
		1.5	1950 ≤ Fg ≤ 2250
		1.2	1600 ≤ Fg ≤ 1850
EVALON GV	non-woven glass fibre with synthetic clutch approx. 120	1.5	1900 ≤ Fg ≤ 2200
		1.2	1550 ≤ Fg ≤ 1800
EVALON VG	non-woven glass fibre with polyester fleece approx. 210	1.5	2000 ≤ Fg ≤ 2300
		1.2	1650 ≤ Fg ≤ 1900
EVALON V Solar with PV-module on top	polyester fleece approx. 160	1.8	4000 ≤ Fg ≤ 4500

### 1.1.2 Fasteners and washers

For fastening the waterproofing membrane to the substrate fasteners can be used from the manufacturer EJOT according to ETA-07/0013, the manufacturer ETANCO according to ETA-08/0239, the manufacturer SFS intec according to ETA-08/0262 and from the manufacturer Zahn according to ETA-08/0033. The fasteners are CE-marked on the basis of the relevant ETAs.

The different fasteners are stated in table 2.

Table 2: Fasteners and washers

Trade name	Type	Nature	Geometry
EJOT Dabo TKR-4,8	screw	coated carbon steel	4.8 x L mm
EJOT Dabo TKE-4,8	screw	stainless steel	4.8 x L mm
EJOT Dabo FBS-R-6,3	screw	coated carbon steel	6.3 x L mm
EJOT Dabo FPS-E-8,0	screw	stainless steel	8.0 x L mm
ETANCO EHB DF 2C	screw	coated carbon steel	4.8 x L mm
ETANCO BETOFAST TH DF 3C	screw	coated carbon steel	6.6 x L mm
ETANCO MULTIFAST TB DF INOX A2	screw	coated carbon steel	6.0 x L mm
ETANCO ISODRILL TH DF	screw	stainless steel	4.8 x L mm
SFS IR2-4.8 x L	screw	coated carbon steel	4.8 x L mm
SFS IR2-S-4.8 x L	screw	stainless steel	4.8 x L mm
SFS IR2-C-4.8 x L	screw	coated carbon steel	4.8 x L mm
SFS IR3-4.8 x L	screw	coated carbon steel	4.8 x L mm
SFS IR3-S-4.8 x L	screw	stainless steel	4.8 x L mm
SFS DT-4.8 x L	anchor	coated carbon steel	4.8 x L mm
SFS DT-S-4.8 x L	anchor	stainless steel	4.8 x L mm
SFS DT-6,3 x L	anchor	coated carbon steel	6.3 x L mm
SFS DT-S-6,3 x L	anchor	stainless steel	6.3 x L mm
SFS IW-T-5.0 x L	screw	coated carbon steel	5.0 x L mm
SFS IW-S-5.0 x L	screw	stainless steel	5.0 x L mm

Trade name	Type	Nature	Geometry
SFS TPR-L- x L	rivet	aluminium	6.3 x L mm
SFS BS-4,8xL	screw	coated carbon steel	4.8 x L mm
SFS BS-S-4,8xL	screw	stainless steel	4.8 x L mm
SFS BS3-4,8xL	screw	coated carbon steel	4.8 x L mm
SFS LBS-S-T25-8,0xL	screw	stainless steel	8.0 x L mm
SFS FB-S-T25-7,5xL	screw	stainless steel	7.5 x L mm
SFS TI-6,3xL	screw	coated carbon steel	6.3 x L mm
SFS TI-T25-6,3xL	screw	coated carbon steel	6.3 x L mm
Zahn ZHBK	screw	carbon steel, specially corrosion-protected	4.8 x L mm
Zahn ZGBK-E	screw	stainless steel	6.0 x L mm
Zahn ZKSK	washer	plastic material	40 x 80 mm
	screw	carbon steel, specially corrosion-protected	4.8 x L mm
Zahn ZHSK	washer	plastic material	40 x 80 mm
	screw	carbon steel, specially corrosion-protected	4.8 x L mm
Zahn ZSDK	washer	plastic material	40 x 80 mm
	screw	carbon steel, specially corrosion-protected	4.8 x L mm
Zahn ZTSD	washer	plastic material	40 x 80 mm
	screw	carbon steel, specially corrosion-protected	4.8 x L mm
Zahn ZK GK-E/R	washer	plastic material	∅ 50 mm x L mm
	screw	stainless steel	6.0 x L mm

The different washers are stated in table 3.

Table 3: Washers

Trade name	Type	Nature	Geometry
EJOT HTK 50 x L	washer	polyamid	∅ 50 mm, L mm
EJOT EcoTek 50 x L	washer	polyethylene	∅ 50 mm, L mm
EJOT HTV 82/40	washer	carbon steel, alu-zinc-coated	82 x 40 mm
EJOT HTV 82/40 TK	washer	carbon steel, alu-zinc-coated	82 x 40 mm
ETANCO 82 x 40 R	washer	recessed reinforced steel plate with aluzinc alloy protection	82 x 40 mm
ETANCO 82 x 40 R DF	washer	recessed reinforced steel plate with aluzinc alloy protection	82 x 40 mm
SFS IR 82 x 40	washer	steel plate with aluzinc protection	82 x 40 mm
SFS IRC/W 82 x 40	washer	steel plate with aluzinc protection	82 x 40 mm
SFS IF/IG-C 82 x 40	washer	steel plate with aluzinc protection	82 x 40 mm
SFS IE-C 82 x 40	washer	steel plate with aluzinc protection	82 x 40 mm
SFS RP45 x L	washer	Polypropylen	∅ 43 mm
SFS R45 x L	washer	Polypropylen	∅ 45 mm

Trade name	Type	Nature	Geometry
Zahn ZLVT 0015	washer	carbon steel, specially corrosion-protected	ø 50 mm
Zahn ZLVT 0005	washer	carbon steel, specially corrosion-protected	80 x 40 mm
Zahn ZLVT 0008	washer	carbon steel, specially corrosion-protected	80 x 40 mm

## 1.2 Intended use

The mechanically fastened flexible roof waterproofing system EVALON is intended to create a roof waterproofing for non-utilized roofs.

The roof waterproofing system can be installed on flat or sloped roofs to resist the passage of water to the building's internal structure. The possible substrates are specified sheet decks, concrete, aerated concrete or timber (see Annex 5 to 7).

In the manufacturer's technical dossier<sup>8</sup> (MTD) to this European technical approval (ETA) the manufacturer gives information concerning the substrates which the mechanically waterproofing system is suitable for and how these substrates shall be pretreated.

The insulation material must be CE marked according to the relevant harmonized European standards and shall have a minimum stiffness as stated in clause 4.2.

The provisions made in this ETA are based on an assumed intended working life<sup>9</sup> of the mechanically fastened waterproofing system of 10 years, provided that the roof waterproofing kit is subjected to appropriate installation, use and maintenance. These provisions are based upon the current state of the art and the available knowledge and experience.

The indications given on the working life cannot be interpreted as a guarantee given by the producer, but are to be regarded only as a means for choosing the right products in relation to the expected economically reasonable working life of the works.

## 2 Characteristics of product and methods of verification

### 2.1 Characteristics of the roof waterproofing system

The components of the mechanically fastened roof waterproofing system show the characteristic values with respect to the permissible tolerances which are stated in the MTD to this ETA. The permissible tolerances do not affect the characteristics of the products and the assembled system negatively.

The chemical composition and the characteristic values of the components of the kit and the manufacturing methods are confidential and deposited with DIBt.

Requirements concerning safety in case of fire, hygiene, health and the environment and safety in use as well as the durability in the sense of the essential requirements N° 2 to N° 4 of the Directive 89/106/EEC shall be satisfied.

<sup>8</sup> The manufacturer's technical dossier (MTD) comprises all information necessary for the production and the installation of the product as well as for the repair of the waterproofing system made from that and it is deposited with DIBt. It was checked by DIBt and it was found to be in accordance with the conditions stated in the approval and the characteristic values determined during the approval testing.

<sup>9</sup> "Assumed intended working life" means that it is expected that, when this working life has elapsed, the real working life may be, under normal use conditions, considerably longer without major degradation affecting the essential requirements.

The property values of the waterproofing sheets and the assembled systems, which are verified by the approval testing, fulfil the requirements of the ETAG 006 as far as they are given. An evaluation for the intended use of the waterproofing system can be carried out with them by the user taking account of national requirements of member states where the product shall be used.

The performance of the reaction to fire behavior of the waterproofing sheets lead to the classification in class E according to EN 13501-1<sup>10</sup>. This is part of the CE-marking of the sheets.

The classification of the external fire performance of the roof waterproofing system for the waterproofing of roofs according to EN 13501-5<sup>11</sup> is not specified. Option class F<sub>ROOF</sub> is taken.

*Remark: For different roofing systems classification documents for the classification in class B<sub>ROOF</sub> (t1), and (t3) according to EN 13501-5 are available.*

According to the manufacturer's declaration the mechanically fastened roof waterproofing system does not contain any dangerous substances taking account of the EU database<sup>12</sup>. Within the scope of this approval there may be other requirements applicable to dangerous substances resulting from transposed European legislation or applicable national laws, regulations and administrative provisions.

The characteristic values of the waterproofing sheets which are CE-marked in accordance with EN 13956 are given in the annexes 2 to 4.

The admissible combinations of sheets and fasteners including washer and the admissible design values for wind loading ( $w_{adm}$ ) of the assembled system are given in annex 5 to 7.

There may be other requirements applicable to the products resulting from other applicable national laws, regulations and administrative provisions and transposed European legislation.

These requirements need also to be complied with, when and where they apply.

## 2.2 Methods of verification

Assessment of the fitness of the roof waterproofing system for the intended use with regard to the essential requirements N° 2 to N° 4 was performed following the ETAG 006.

## 3 Evaluation and attestation of conformity and CE marking

### 3.1 System of attestation of conformity

According to the Decision 98/143/EC of the European Commission<sup>13</sup> system 2+ for the procedure of attestation of conformity (Annex III, clause 2(ii) first possibility of Directive 89/106/EEC) applies for mechanically fastened roof waterproofing system.

The system 2+ of attestation of conformity is defined as follows:

System 2+: Declaration of conformity of the product by the manufacturer on the basis of:

- (a) Tasks for the manufacturer:
  - (1) initial type-testing of the product;
  - (2) factory production control;
  - (3) testing of samples taken at the factory in accordance with a prescribed test plan.

<sup>10</sup> EN 13501-1:2007+A1:2009 Fire classification of construction products and building elements – Part 5: Classification using data from reaction to fire tests

<sup>11</sup> EN 13501-5:2005+A1:2009 Fire classification of construction products and building elements – Part 1: Classification using data from external fire exposure to roofs tests"

<sup>12</sup> Notes are stated in Guidance Paper H: A harmonized approach relating to Dangerous substances under the construction product directive, Brussels, 18 February 2000

<sup>13</sup> Official Journal of the European Communities L 42, 14 February 1998

- (b) Tasks for the notified body:
- (4) certification of factory production control on the basis of:
- initial inspection of factory and of factory production control;
  - continuous surveillance, assessment and approval of factory production control.

### **3.2 Responsibilities**

For the components sheet and fastener are provided that the attestation of conformity processes according to EN 13956 respectively to the relevant ETAs are verified on basis of these technical specifications. The additional attestation of conformity is only related to assemble the components to the kit according annex 5 to 7. It shall be done by the declaration of conformity and the CE marking of the kit by the manufacturer according to clause 3.3 respectively 3.2.1.3.

#### **3.2.1 Task of the manufacturer**

##### **3.2.1.1 Factory production control**

The manufacturer shall exercise permanent internal control of production. All the elements, requirements and provisions adopted by the manufacturer shall be documented in a systematic manner in the form of written policies and procedures, including records of results performed. This production control system shall insure that the product is in conformity with this ETA.

The factory production control shall be in accordance with the appropriate part of the control plan<sup>14</sup> which is a confidential part of the MTD and is deposited with DIBt.

The factory production control is in conformity with ETAG 006.

The manufacturer may only use products according to the MTD. He shall inspect or control the initial materials on acceptance according to the control plan.

The results of the factory production control shall be recorded and evaluated in accordance with the provisions of the control plan.

The records shall include at least the following information:

- Name of the product,
- type of inspection or control,
- date of manufacture of the product, batch N° if needed, and date of inspection or control of the product,
- result of inspections or controls and, as far as applicable, comparison with the requirements,
- signature of the person responsible for the factory production control.

The records shall be kept for at least five years. On request they shall be presented to DIBt.

Details concerning extent, type and frequency of the tests or inspections to be performed within the scope of the factory production control shall correspond to the control plan which is part of the MTD to this ETA.

<sup>14</sup>

The control plan is a confidential part of the MTD to this ETA and deposited with DIBt. It contains the required information on the factory production control, on the initial type-testing and the initial inspection of the factory and the continuous surveillance, assessment and approval of factory production control. As far as this is relevant to the tasks of the notified body involved in the procedure of attestation of conformity the control plan will be handed over to the notified body.



**3.2.1.2 Initial type-testing of the product**

The initial type-testing refers to the product properties stated in the appropriate part of the control plan to this ETA. The initial type-testing is conform to ETAG 006.

If the verifications underlying this ETA have been furnished on samples from the current production, these will replace the initial type-testing.

Otherwise the necessary initial type-testing shall be carried out according to the provisions of the control plan and observance of the required property values shall be ascertained by the notified body.

After changing the production process or starting the production in another manufacturing plant the initial type-testing shall be repeated.

**3.2.1.3 Other tasks for the manufacturer**

The manufacturer shall, on the basis of a contract, involve a body which is notified for the tasks referred to in section 3.1 in the field of the product in order to undertake the actions laid down in section 3.2.2. For this purpose, the control plan referred to in section 3.2.2 shall be handed over by the manufacturer to the notified body involved.

The manufacturer shall make a declaration of conformity, stating that the product is in conformity with the provisions of this ETA.

**3.2.2 Task of the notified body**

**3.2.2.1 Initial inspection of factory and factory production control**

The appropriate part of the control plan states the information on the properties which have to be controlled by the notified body involved for initial inspection of factory and factory production control. The notified body has to control the devices and equipments and the documentation of the factory production control of the manufacturer when starting the production or starting a new production line.

The notified body shall retain the essential points of its actions referred to above and state the results obtained and conclusions drawn in a written report.

The notified certification body involved by the manufacturer shall issue an EC certificate of conformity of the factory production control stating the conformity with the provisions of this ETA.

After changing the production process or starting the production in another manufacturing plant the initial inspection of factory and factory production control shall be repeated. The notified body shall issue a new EC certificate of conformity of the factory control stating the conformity with the provisions of this ETA.

**3.2.2.2 Continuous surveillance, judgment and assessment of factory production control**

The appropriate part of the control plan states the information on the properties which have to be checked by the notified body involved. The frequency of this tasks shall be twice a year.

The notified body shall retain the essential points of its actions referred to above and state the results obtained and conclusions drawn in a written report.

In cases where the provisions of this ETA and its control plan are no longer fulfilled the certification body involved shall withdraw the certification of conformity and inform DIBt without delay.

### 3.3 CE marking of the kit

The CE marking<sup>15</sup> shall be affixed by the manufacturer on the packaging of the kit of the roof waterproofing "EVALON" or its accompanying documents.

The letters "CE" shall be followed by the identification number of the notified body, and be accompanied by the following additional information:

- name and address or identifying mark of the manufacturer,
- last two digits of the year in which the CE marking was affixed,
- number of the EC certificate for the factory production control,
- number of the European technical approval: ETA-08/0112,
- number of the European technical approval guideline: ETAG 006.

The approved components shall be specified as belonging to the mechanically fastened roof waterproofing kit "EVALON".

CE marking and accompanying information:

	Letters "CE"
<i>nnnn</i>	Identification number of notified body (system 2+)
alwitra GmbH & Co. Klaus Göbel Am Forst 1 54296 Trier Germany	Name and address of the producer
<i>08</i> <i>nnnn-CPD-xxxx</i>	two last digits of year of affixing CE marking number of the EC certificate for the FPC
ETA-08/0112 ETAG 006	ETA number ETAG number
Mechanically fastened roof waterproofing system	intended use
Declared values of the product and the system see Annexes of ETA-08/0112	classification and characteristics of the product

## 4 Assumptions under which the fitness of the product for the intended use was favourably assessed

### 4.1 Manufacturing

The components of the kit of the mechanically fastened roof waterproofing kit are factory-made according to the procedure laid down in the MTD.

The ETA is issued for the kit on the basis of the product of agreed data/information, deposited with DIBt, which identifies the kit that has been assessed and judged. Changes to the components of the kit or in the production process of the components, which could result in the production process and/or the properties of the product deposited being incorrect should be notified to DIBt before the changes are introduced. DIBt will decide whether or not such changes affect the ETA and consequently the validity of the CE marking on the basis of the ETA and if so whether further assessment or alterations to the ETA shall be necessary.

<sup>15</sup> Notes on the CE marking are stated in Guidance Paper D "CE marking under the Construction Products Directive", Brussels, 1 August 2002

#### 4.2 Design and dimensioning

The fitness for the respective use of the mechanically fastened roof waterproofing results from the characteristic values stated in the annexes and the design values for the wind loads according annexes 5 till 7, if need be, taking account of national requirements.

Furthermore the details demonstrated according annexes 8 till 17 shall be considered.

The supplementing statements of the manufacturer stated in the MTD for design and application of the waterproofing system shall be considered.

Especially the following factors should be taken into account:

- dead and imposed loads,
- design with respect to the decisive wind pressure on roof areas,
- structural strength, stiffness and deflection limits,
- attachment of the roof deck to the structural framing,
- provision of insulation,
- assessment of condensation risk and provisions of vapour control layers,
- sound insulation,
- fire precaution,
- roof attachments, fixture and penetrations,
- falls and drainage,
- means of access for inspection and maintenance.

The substrate onto which the waterproofing kit is to be laid should be sufficiently rigid, dense and dimensionally stable to support the system (sheet and insulation).

Insulation material

The compression behaviour of the insulation material:

It shall be ensured that the insulation material on site has:

- a 10 % compression  $\geq 60$  kPa (EN 826)
- a point load behaviour  $\geq 500$  Pa, deformation 5 mm (EN 12430)

The insulation material must be CE marked according to the relevant harmonized European standard. The durability shall be assessed in accordance with these standards.

The thickness of the insulation material should be designed in accordance with national regulations.

#### 4.3 Installation

The fitness for use of the mechanically fastened roof waterproofing system can be assumed only, if the installation is carried out according to the installation instructions stated in the MTD by the manufacturer, in particular taking account of the following points:

- installation by appropriately trained personnel,
- installation of only those components which are marked as components of the system,
- installation with the required tools and adjuvants,
- precautions during installation,
- inspecting the substrate surface for cleanliness and correct preparation,
- inspecting compliance with suitable weather conditions, avoid installation when temperature falls under 5 °C and the following weather conditions: high humidity, rain, snow or fog. By preheating the seam areas, welding is also possible at lower ambient temperatures,

- overlap: the longitudinal overlap between the sheets must be always at least 110 mm and the joint can be welded with hot air and must have at least 20 mm in width or can be welded with solvent and must be have at least 30 mm in width,
- overlap: when ends of fleece backed membranes are be joint (transversal-overlap), this is done by tightly butting the ends together and covering them with a 160 mm wide unbacked membrane-strip centrally welded over the joint with hot air or with solvent,
- inspections during installation and of the finished roof waterproofing system and documentation of the results.

The information as to the

- method of repair on site,
  - handling of waste products
- shall be observed.

#### 4.4 Manufacturer's responsibilities

It is the manufacturer's responsibility to make sure that all those who utilize the approved roof waterproofing system will be appropriately informed about the specific conditions according to sections 1, 2, 4, and 5 including the annexes to this ETA and the not confidential parts of the MTD deposited to this ETA.

### 5 Indications of the manufacturer

#### 5.1 Packaging, transport and storage

Information on:

- Packaging,
- transport and
- storage
- are given in the MTD.

#### 5.2 Use, maintenance and repair

Information on:

- Use
  - maintenance
  - repair
- are given in the MTD.

Dirk Brandenburger  
Head of Department

*beglaubigt:*  
Hemme

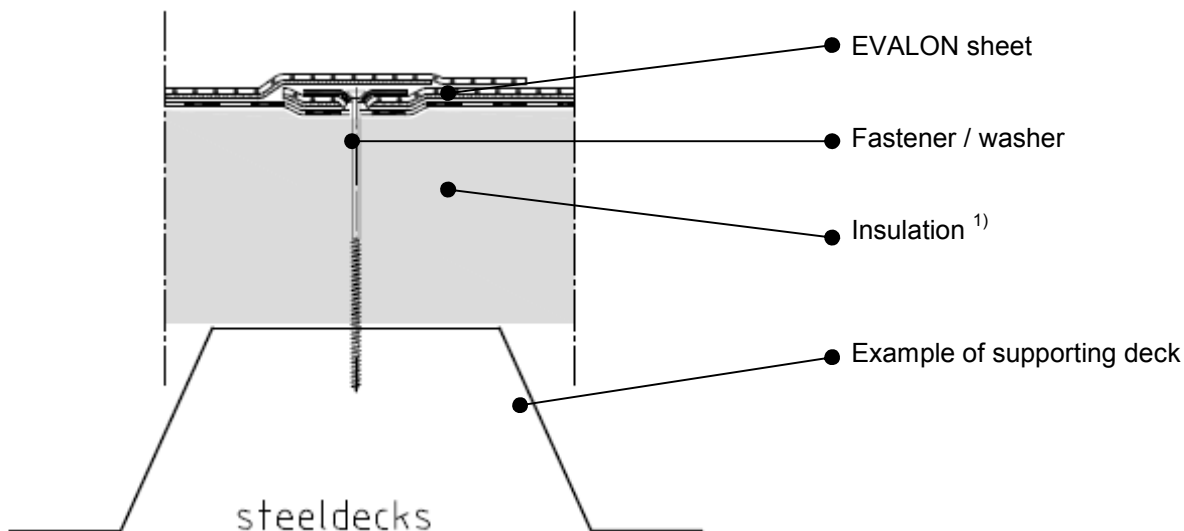

- <sup>1)</sup> It shall be ensured that the insulation material on site has:
- a 10 % compression  $\geq 60$  kPa (EN 826)
  - a point load behaviour  $\geq 500$  Pa, deformation 5 mm (EN 12430)
- The insulation material must be CE marked according to the relevant harmonized European standard.

Reaction to fire: class E according to EN 13501-1  
 External fire performance of roofs: class F<sub>ROOF</sub> according to EN 13501-5

Information for users on external fire performance of roof decks:  
 According to declaration of conformity of the sheets the classification B<sub>ROOF</sub>(t1) and B<sub>ROOF</sub>(t3) is only valid for supporting decks which are described in the classification documents according EN V 1187 and according EN 13501-5.

Electronic copy of the ETA by DIBt: ETA-08/0112

EVALON	Annex 1
System build-up	

cladding/backing layer [g/m <sup>2</sup> ]	effective thickness [mm]	mass per unit area [g/m <sup>2</sup> ]
non-woven glass fibre with synthetic clutch approx. 120	1.5	1900 ≤ F <sub>g</sub> ≤ 2200
	1.2	1550 ≤ F <sub>g</sub> ≤ 1800
non-woven glass fibre with polyester fleece approx. 210	1.5	2000 ≤ F <sub>g</sub> ≤ 2300
	1.2	1650 ≤ F <sub>g</sub> ≤ 1900

Characteristic	test method	EVALON:	VG	GV	expression
		dimension	value	value	
reaction to fire <sup>1)</sup>	EN 11925-2		class E	class E	EN 13501-1
water tightness <sup>1)</sup>	EN 1928 test B	kPa	≥ 400	≥ 400	MLV
peel resistance of joints <sup>1)</sup>	EN 12316-2	N/50 mm	≥ 80	≥ 80	MLV
shear resistance of joints <sup>1)</sup>	EN 12317-2	N/50 mm	≥ 200	≥ 200	MLV
tensile strength <sup>1)</sup>	EN 12311-2	N/50 mm	≥ 500	≥ 700	MLV
tensile elongation <sup>1)</sup>	EN 12311-2	%	≥ 60	≥ 10	MLV
resistance against dynamic indentation <sup>1)</sup>	EN 12691 test A	mm	≥ 300	≥ 300	MLV
resistance against static indentation <sup>1)</sup>	EN 12730 test B	kg	≥ 20	≥ 20	MLV
resistance to tearing <sup>1)</sup>	EN 12310-2	N	≥ 80	≥ 80	MLV
dimensional stability <sup>1)</sup>	EN 1107-2	%	≤ 1	≤ 1	MLV
resistance to cold bending <sup>1)</sup>	EN 495-5	°C	≤ -25	≤ -25	MLV
resistance to UV radiation <sup>1)</sup>	EN 1297	visible			pass
resistance to hail <sup>1)</sup>	EN 13583	m/s	≥ 30	≥ 30	MLV
water vapour transmission <sup>1)</sup>	EN 1931	μ	20000	20000	MDV
exposure to bitumen <sup>1)</sup>	prEN 1584				pass
resistance to liquid chemicals including water <sup>1)</sup>	EN 1847				pass <sup>3)</sup>
root resistance <sup>1)</sup>	prEN 13948				pass
<b>Resistance to heat ageing, EN 1296<sup>2)</sup></b>					
peel resistance of joints	EN 12316-2	%	Δ ≤ 20	Δ ≤ 20	pass
shear resistance of joints	EN 12317-2	%	Δ ≤ 20	Δ ≤ 20	pass
resistance to tearing	EN 12310-2	%	Δ ≤ 20	Δ ≤ 20	pass
resistance to cold bending	EN 495-5	°C	Δ ≤ 15	Δ ≤ 15	pass
<b>Resistance to UV radiation in the presence of moisture, EOTA TR 010<sup>2)</sup></b>					
resistance to cold bending	EN 495-5	°C	Δ ≤ 15	Δ ≤ 15	pass
<b>Resistance to water ageing, EN 1847<sup>2)</sup></b>					
peel resistance of joints	EN 12316-2	%	Δ ≤ 20	Δ ≤ 20	pass

1) These values are manufacturer values stated by the CE-marking according to EN 13956

2) These values are determined in accordance with ETAG 006

3) according to EN 13956 list C

Waterproofing sheet: EVALON GV and EVALON VG

Characteristics

Annex 2

cladding/backing layer [g/m <sup>2</sup> ]	effective thickness [mm]	mass per unit area [g/m <sup>2</sup> ]
polyester fleece approx. 160	1.8	2300 ≤ F <sub>g</sub> ≤ 2650
	1.5	1950 ≤ F <sub>g</sub> ≤ 2250
	1.2	1600 ≤ F <sub>g</sub> ≤ 1850

Characteristic	test method	dimension	value	expression
reaction to fire <sup>1)</sup>	EN 11925-2		class E	EN 13501-1
water tightness <sup>1)</sup>	EN 1928 test B	kPa	≥ 400	MLV
peel resistance of joints <sup>1)</sup>	EN 12316-2	N/50 mm	≥ 80	MLV
shear resistance of joints <sup>1)</sup>	EN 12317-2	N/50 mm	≥ 200	MLV
tensile strength <sup>1)</sup>	EN 12311-2	N/50 mm	≥ 500	MLV
tensile elongation <sup>1)</sup>	EN 12311-2	%	≥ 60	MLV
resistance against dynamic indentation <sup>1)</sup>	EN 12691 test A	mm	≥ 300	MLV
resistance against static indentation <sup>1)</sup>	EN 12730 test B	kg	≥ 20	MLV
resistance to tearing <sup>1)</sup>	EN 12310-2	N	≥ 80	MLV
dimensional stability <sup>1)</sup>	EN 1107-2	%	≤ 1	MLV
resistance to cold bending <sup>1)</sup>	EN 495-5	°C	≤ -25	MLV
resistance to UV radiation <sup>1)</sup>	EN 1297	visible		pass
resistance to hail <sup>1)</sup>	EN 13583	m/s	≥ 30	MLV
water vapour transmission <sup>1)</sup>	EN 1931	μ	20000	MDV
exposure to bitumen <sup>1)</sup>	prEN 1584			pass
resistance to liquid chemicals including water <sup>1)</sup>	EN 1847			pass <sup>3)</sup>
root resistance <sup>1)</sup>	prEN 13948			pass
<b>Resistance to heat ageing, EN 1296<sup>2)</sup></b>				
peel resistance of joints	EN 12316-2	%	Δ ≤ 20	pass
shear resistance of joints	EN 12317-2	%	Δ ≤ 20	pass
resistance to tearing	EN 12310-2	%	Δ ≤ 20	pass
resistance to cold bending	EN 495-5	°C	Δ ≤ 15	pass
<b>Resistance to UV radiation in the presence of moisture, EOTA TR 010<sup>2)</sup></b>				
resistance to cold bending	EN 495-5	°C	Δ ≤ 15	pass
<b>Resistance to water ageing, EN 1847<sup>2)</sup></b>				
peel resistance of joints	EN 12316-2	%	Δ ≤ 20	pass

<sup>1)</sup> These values are manufacturer values stated by the CE-marking according to EN 13956

<sup>2)</sup> These values are determined in accordance with ETAG 006

<sup>3)</sup> according EN 13956 list C

Waterproofing sheet EVALON V

Characteristics

Annex 3

cladding/backing layer [g/m <sup>2</sup> ]	effective thickness [mm]	mass per unit area [g/m <sup>2</sup> ]
polyester fleece approx. 160	1.8	4000 ≤ F <sub>g</sub> ≤ 4500

**With pre-fabricated Photo voltaic-module on top**

Characteristic	test method	dimension	value	expression
reaction to fire <sup>1)</sup>	EN 11925-2		class E	EN 13501-1
water tightness <sup>1)</sup>	EN 1928 test B	kPa	≥ 400	MLV
peel resistance of joints <sup>1)</sup>	EN 12316-2	N/50 mm	≥ 80	MLV
shear resistance of joints <sup>1)</sup>	EN 12317-2	N/50 mm	≥ 200	MLV
tensile strength <sup>1)</sup>	EN 12311-2	N/50 mm	≥ 500	MLV
tensile elongation <sup>1)</sup>	EN 12311-2	%	≥ 60	MLV
resistance against dynamic indentation <sup>1)</sup>	EN 12691 test A	mm	≥ 300	MLV
resistance against static indentation <sup>1)</sup>	EN 12730 test B	kg	≥ 20	MLV
resistance to tearing <sup>1)</sup>	EN 12310-2	N	≥ 80	MLV
dimensional stability <sup>1)</sup>	EN 1107-2	%	≤ 1	MLV
resistance to cold bending <sup>1)</sup>	EN 495-5	°C	≤ -25	MLV
resistance to UV radiation <sup>1)</sup>	EN 1297	visible		pass
resistance to hail <sup>1)</sup>	EN 13583	m/s	≥ 30	MLV
water vapour transmission <sup>1)</sup>	EN 1931	μ	20000	MDV
exposure to bitumen <sup>1)</sup>	prEN 1584			pass
resistance to liquid chemicals including water <sup>1)</sup>	EN 1847			pass <sup>3)</sup>
<b>Resistance to heat ageing, EN 1296<sup>2)</sup></b>				
peel resistance of joints	EN 12316-2	%	Δ ≤ 20	pass
shear resistance of joints	EN 12317-2	%	Δ ≤ 20	pass
resistance to tearing	EN 12310-2	%	Δ ≤ 20	pass
resistance to cold bending	EN 495-5	°C	Δ ≤ 15	pass
<b>Resistance to UV radiation in the presence of moisture, EOTA TR 010<sup>2)</sup></b>				
resistance to cold bending	EN 495-5	°C	Δ ≤ 15	pass
<b>Resistance to water ageing, EN 1847<sup>2)</sup></b>				
peel resistance of joints	EN 12316-2	%	Δ ≤ 20	pass

- 1) These values are manufacturer values stated by the CE-marking according to EN 13956  
 2) These values are determined in accordance with ETAG 006  
 3) according EN 13956 list C

Waterproofing sheet EVALON V Solar

Characteristics

Annex 4



Admissible wind load per fastener with waterproofing sheet  
EVALON GV and EVALON VG for different types of substrates

Screw	Washer	Sheet deck			Timber				Concrete EN 206-1	Aerated concrete EN 12602 EN 1520
		1	2	3	1	2	3	4		
W <sub>adm</sub> [N]										
EJOT Dabo TKR/TKE (4.8xL)	HTK 50 x L	500								
EJOT Dabo TKR/TKE (4.8xL)	HTK 50 x L					500	--			
EJOT Dabo FBS-R (6.3 x L)	EcoTek 50 x L								400 <sup>3)</sup>	
EJOT Dabo FBS-R (6.3 x 35)	HTV 82/40 F								400 <sup>3)</sup>	
EJOT Dabo FPS-E (8.0 x 80)	HTV 82/40 F									400 <sup>9)</sup>
EJOT Dabo FPS-E (8.0 x 80)	EcoTek 50 x L									400 <sup>9)</sup>
Etanco EHB DF 2C 2,5	Etanco 82x40 R DF	600					500			
Etanco MULTIFAST TB INOX A2	Etanco 82x40 R						500			400 <sup>8)</sup>
Etanco BETOFAST TH DF 3C	Etanco 82x40 R								500 <sup>5)</sup>	
SFS IR2-4,8xL	IR 82x40	600					500			
SFS IR2-S-4,8xL	IR 82x40	600					500			
SFS IR2-C-4,8xL	IRC/W 82x40	600					500			
SFS IR3-4,8xL	IR 82x40	600								
SFS IR3-S-4,8xL	IR 82x40	600								
SFS IW-T-5 x35	IRC/W 82x40						500			
SFS IW-S-5 x35	IRC/W 82x40						500			
SFS DT-4,8xL	R45 x L								500 <sup>2)</sup>	
SFS DT-S-4,8xL	R45 x L								500 <sup>2)</sup>	
SFS DT-4,8xL	IF/IG-C 82x40								500 <sup>2)</sup>	
SFS DT-S-4,8xL	IF/IG-C 82x40								500 <sup>2)</sup>	
SFS DT-6,3xL	IF/IG-C 82x40								500 <sup>4)</sup>	
SFS DT-S-6,3xL	IF/IG-C 82x40								500 <sup>4)</sup>	
SFS TPR-L-xL	IRD 82x40			400						
SFS BS-4,8xL	RP 45xL	600					500			
SFS BS-S-4,8xL	RP 45xL	600					500			
SFS BS3-4,8xL	RP 45xL		600							
SFS LBS-S-T25-8,0xL	R45 x L									400 <sup>9)</sup>
SFS LBS-S-T25-8,0xL	IE-C-82x40									400 <sup>9)</sup>
SFS LBS-S-T25-8,0xL	IF/IG-C 82x40									400 <sup>9)</sup>
SFS FB-S-T25-7,5xL	R45 x L									400 <sup>7)</sup>
SFS FB-S-T25-7,5xL	IE-C-82x40									400 <sup>7)</sup>
SFS FB-S-T25-7,5xL	IF/IG-C 82x40									400 <sup>7)</sup>
SFS TI-6,3xL	IF/IG-C 82x40								500 <sup>1)</sup>	
SFS TI-T25-6,3xL	R45 x L								500 <sup>1)</sup>	
Zahn ZKSK		600								
Zahn ZHBK	ZLVT 0005 / 0015						500			
Zahn ZHSK							500			
Zahn ZSDK									500 <sup>6)</sup>	
Zahn ZTSD									500 <sup>6)</sup>	
Zahn ZGBK-E	ZLVT 0008									400 <sup>9)</sup>
Zahn ZKGG-E/R										400 <sup>9)</sup>

Timber

- 1 structural timber EN 338/C24, t ≥ 22 mm, effective embedment depth ≥ 22 mm
- 2 polywood BFU 100 EN 636, t ≥ 19 mm, effective embedment depth ≥ 19 mm
- 3 OSB3 EN 300, t ≥ 18 mm, effective embedment depth ≥ 18 mm
- 4 particle board EN 312/P5, t ≥ 19 mm, effective embedment depth ≥ 19 mm

Sheet Deck

- 1 Steel S280GD – EN 10326, t ≥ 0.75 mm
- 2 Steel S280GD – EN 10326, t ≥ 1.0 mm
- 3 Aluminium, R<sub>m</sub> ≥ 195 N/mm<sup>2</sup>, t ≥ 1.0 mm

Concrete and aerated concrete

- 1) effective anchorage depth ≥ 20 mm
- 2) effective anchorage depth ≥ 25 mm
- 3) effective anchorage depth ≥ 30 mm
- 4) effective anchorage depth ≥ 32 mm
- 5) effective anchorage depth ≥ 35 mm stated by the manufacturer
- 6) effective anchorage depth ≥ 40 mm
- 7) effective anchorage depth ≥ 50 mm
- 8) effective anchorage depth ≥ 55 mm stated by the manufacturer
- 9) effective anchorage depth ≥ 60 mm

EVALON GV and EVALON VG

Admissible loads per fastener

Annex 5

Admissible wind load per fastener with waterproofing sheet EVALON V for different types of substrates										
Screw	Washer	Sheet deck			Timber				Concrete	Aerated concrete
		1	2	3	1	2	3	4		
									EN 206-1	EN 12602 EN 1520
$W_{adm}$ [N]										
EJOT Dabo TKR/TKE (4.8xL)	HTK 50 x L	500								
EJOT Dabo TKR/TKE (4.8xL)	HTK 50 x L					500	--			
EJOT Dabo FBS-R (6.3 x L)	EcoTek 50 x L							500 <sup>3)</sup>		
EJOT Dabo FBS-R (6.3 x 35)	HTV 82/40 F							500 <sup>3)</sup>		
EJOT Dabo FPS-E (8.0 x 80)	HTV 82/40 F									400 <sup>8)</sup>
EJOT Dabo FPS-E (8.0 x 80)	EcoTek 50 x L									400 <sup>8)</sup>
Etanco EHB DF 2C 2,5	Etanco 82x40 R DF	500				500				
Etanco MULTIFAST TB INOX A2	Etanco 82x40 R					500				400 <sup>1)</sup>
Etanco BETOFAST TH DF 3C	Etanco 82x40 R							500 <sup>5)</sup>		
SFS IR2-4,8xL	IR 82x40	500				500				
SFS IR2-S-4,8xL	IR 82x40	500				500				
SFS IR2-C-4,8xL	IRC/W 82x40	500				500				
SFS IR3-4,8xL	IR 82x40	500								
SFS IR3-S-4,8xL	IR 82x40	500								
SFS IW-T-5 x35	IRC/W 82x40					500				
SFS IW-S-5 x35	IRC/W 82x40					500				
SFS DT-4,8xL	R45 x L							500 <sup>2)</sup>		
SFS DT-S-4,8xL	R45 x L							500 <sup>2)</sup>		
SFS DT-4,8xL	IF/IG-C 82x40							500 <sup>2)</sup>		
SFS DT-S-4,8xL	IF/IG-C 82x40							500 <sup>2)</sup>		
SFS DT-6,3xL	IF/IG-C 82x40							500 <sup>4)</sup>		
SFS DT-S-6,3xL	IF/IG-C 82x40							500 <sup>4)</sup>		
SFS TPR-L-x L	IRD 82x40			400						
SFS BS-4,8xL	RP 45xL	500				500				
SFS BS-S-4,8xL	RP 45xL	500				500				
SFS BS3-4,8xL	RP 45xL		500							
SFS LBS-S-T25-8,0xL	R45 x L									400 <sup>9)</sup>
SFS LBS-S-T25-8,0xL	IE-C-82x40									400 <sup>9)</sup>
SFS LBS-S-T25-8,0xL	IF/IG-C 82x40									400 <sup>9)</sup>
SFS FB-S-T25-7,5xL	R45 x L									400 <sup>7)</sup>
SFS FB-S-T25-7,5xL	IE-C-82x40									400 <sup>7)</sup>
SFS FB-S-T25-7,5xL	IF/IG-C 82x40									400 <sup>7)</sup>
SFS TI-6,3xL	IF/IG-C 82x40							500 <sup>1)</sup>		
SFS TI-T25-6,3xL	R45 x L							500 <sup>1)</sup>		
Zahn ZKSK		500								
Zahn ZHBK	ZLVT 0005 + 0015					500				
Zahn ZHSK						500				
Zahn ZSDK								500 <sup>6)</sup>		
Zahn ZTSD								500 <sup>6)</sup>		
Zahn ZGBK-E	ZLVT 0008									400 <sup>8)</sup>
Zahn ZK GK-E/R										400 <sup>8)</sup>

Timber  
 1 structural timber EN 338/C24,  $t \geq 22$  mm, effective embedment depth  $\geq 22$  mm  
 2 polywood BFU 100 EN 636,  $t \geq 19$  mm, effective embedment depth  $\geq 19$  mm  
 3 OSB3 EN 300,  $t \geq 18$  mm, effective embedment depth  $\geq 18$  mm  
 4 particle board EN 312/P5,  $t \geq 19$  mm, effective embedment depth  $\geq 19$  mm

Sheet Deck  
 1 Steel S280GD – EN 10326,  $t \geq 0.75$  mm  
 2 Steel S280GD – EN 10326,  $t \geq 1.0$  mm  
 3 Aluminium,  $R_m \geq 195$  N/mm<sup>2</sup>,  $t \geq 1.0$  mm

Concrete and aerated concrete  
<sup>1)</sup> effective anchorage depth  $\geq 20$  mm  
<sup>2)</sup> effective anchorage depth  $\geq 25$  mm  
<sup>3)</sup> effective anchorage depth  $\geq 30$  mm  
<sup>4)</sup> effective anchorage depth  $\geq 32$  mm  
<sup>5)</sup> effective anchorage depth  $\geq 35$  mm stated by the manufacturer  
<sup>6)</sup> effective anchorage depth  $\geq 40$  mm  
<sup>7)</sup> effective anchorage depth  $\geq 50$  mm  
<sup>8)</sup> effective anchorage depth  $\geq 55$  mm stated by the manufacturer  
<sup>9)</sup> effective anchorage depth  $\geq 60$  mm

EVALON V

Admissible loads per fastener

Annex 6

Admissible wind load per fastener with waterproofing sheet									
EVALON V Solar for different types of substrates									
Screw	Washer	Sheet deck		Timber				Concrete	Aerated concrete
		1	2	1	2	3	4		
								EN 206-1	EN 12602 EN 1520
$W_{adm}$ [N]									
EJOT Dabo TKR / TKE (4.8 x L)	HTK 50 x L	700							
EJOT Dabo TKR / TKE (4.8 x L)	HTK 50 x L				500		--		
EJOT Dabo FBS-R (6.3 x L)	EcoTek 50 x L							500 <sup>3)</sup>	
EJOT Dabo FBS-R (6.3 x 35)	HTV 82/40 F							500 <sup>3)</sup>	
EJOT Dabo FPS-E (8.0 x 80)	HTV 82/40 F								500 <sup>8)</sup>
EJOT Dabo FPS-E (8.0 x 80)	EcoTek 50 x L								500 <sup>8)</sup>
Etanco ISODRILL TH DF	Etanco 82X40 R DF	700							
Etanco MULTIFAST TB DF INOX A2	Etanco 82x40 R				500				400 <sup>7)</sup>
Etanco MULTIFAST TB INOX A2 with plastic plug	Etanco 82X40 R							500 <sup>7)</sup>	
SFS IR2-S-4,8xL	IR 82x40	700			500				
SFS IR3-S-4,8xL	IR 82x40	700							
SFS IW-S-5 x35	IRC/W 82x40				500				
SFS DT-S-4,8xL	R45 x L							500 <sup>2)</sup>	
SFS DT-S-4,8xL	IF/IG-C 82x40							500 <sup>2)</sup>	
SFS DT-S-6,3xL	IF/IG-C 82x40							500 <sup>4)</sup>	
SFS TPR-L-xL	IRD 82x40		400						
SFS BS-S-4,8xL	RP 45xL	700			500				
SFS LBS-S-T25-8,0xL	R45 x L								400 <sup>9)</sup>
SFS LBS-S-T25-8,0xL	IE-C-82x40								400 <sup>9)</sup>
SFS LBS-S-T25-8,0xL	IF/IG-C 82x40								400 <sup>9)</sup>
SFS FB-S-T25-7,5xL	R45 x L								400 <sup>7)</sup>
SFS FB-S-T25-7,5xL	IE-C-82x40								400 <sup>7)</sup>
SFS FB-S-T25-7,5xL	IF/IG-C 82x40								400 <sup>7)</sup>
Zahn ZKSK-E		700							
Zahn ZHBK	ZLVT 0005 + 0015				500				
Zahn ZKGK-E/R					500				
Zahn ZSDK-E								500 <sup>6)</sup>	
Zahn ZTSD-E								500 <sup>6)</sup>	
Zahn ZGBK-E	ZLVT 0008								400 <sup>8)</sup>
Zahn ZKGK-E/R									400 <sup>8)</sup>

Timber  
 1 structural timber EN 338/C24,  $t \geq 22$  mm, effective embedment depth  $\geq 22$  mm  
 2 polywood BFU 100 EN 636,  $t \geq 19$  mm, effective embedment depth  $\geq 19$  mm  
 3 OSB3 EN 300,  $t \geq 18$  mm, effective embedment depth  $\geq 18$  mm  
 4 particle board EN 312/P5,  $t \geq 19$  mm, effective embedment depth  $\geq 19$  mm

Sheet Deck  
 1 Steel S280GD – EN 10326,  $t \geq 0.75$  mm  
 2 Aluminium,  $R_m \geq 195$  N/mm<sup>2</sup>,  $t \geq 1.0$  mm

Concrete and aerated concrete  
 1) effective anchorage depth  $\geq 20$  mm  
 2) effective anchorage depth  $\geq 25$  mm  
 3) effective anchorage depth  $\geq 30$  mm  
 4) effective anchorage depth  $\geq 32$  mm  
 5) effective anchorage depth  $\geq 35$  mm stated by the manufacturer  
 6) effective anchorage depth  $\geq 40$  mm  
 7) effective anchorage depth  $\geq 50$  mm  
 8) effective anchorage depth  $\geq 55$  mm stated by the manufacturer  
 9) effective anchorage depth  $\geq 60$  mm

EVALON V Solar

Admissible loads per fastener

Annex 7

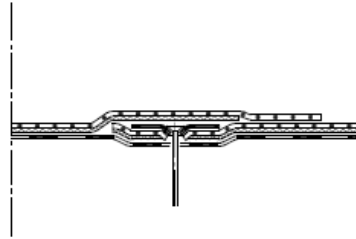

Case 1 : Fixing in overlapping area (edge)  
The Attachmenttigger distance at least 20 mm

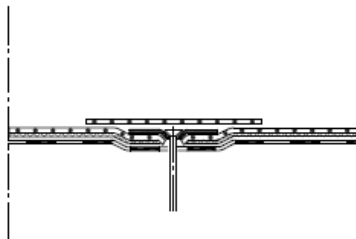

Case 2 : Fixing with membrane discs through the membrane additional  
shipe welded over

EVALON

Fixing examples

Annex 8

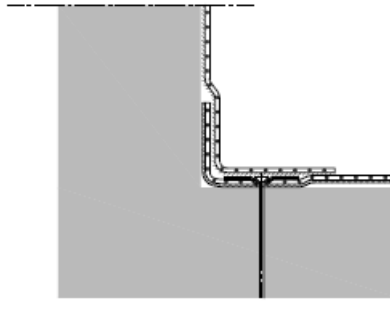

Case 3 : junction waterproofing/fixing with single fasteners

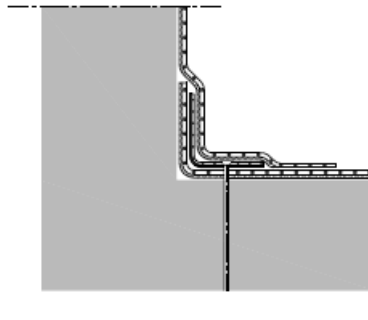

Case 4 : fixing with coated metal sheet

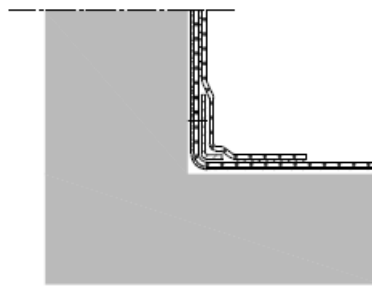

Case 5 : fixing with galvanized with steel sheet angle

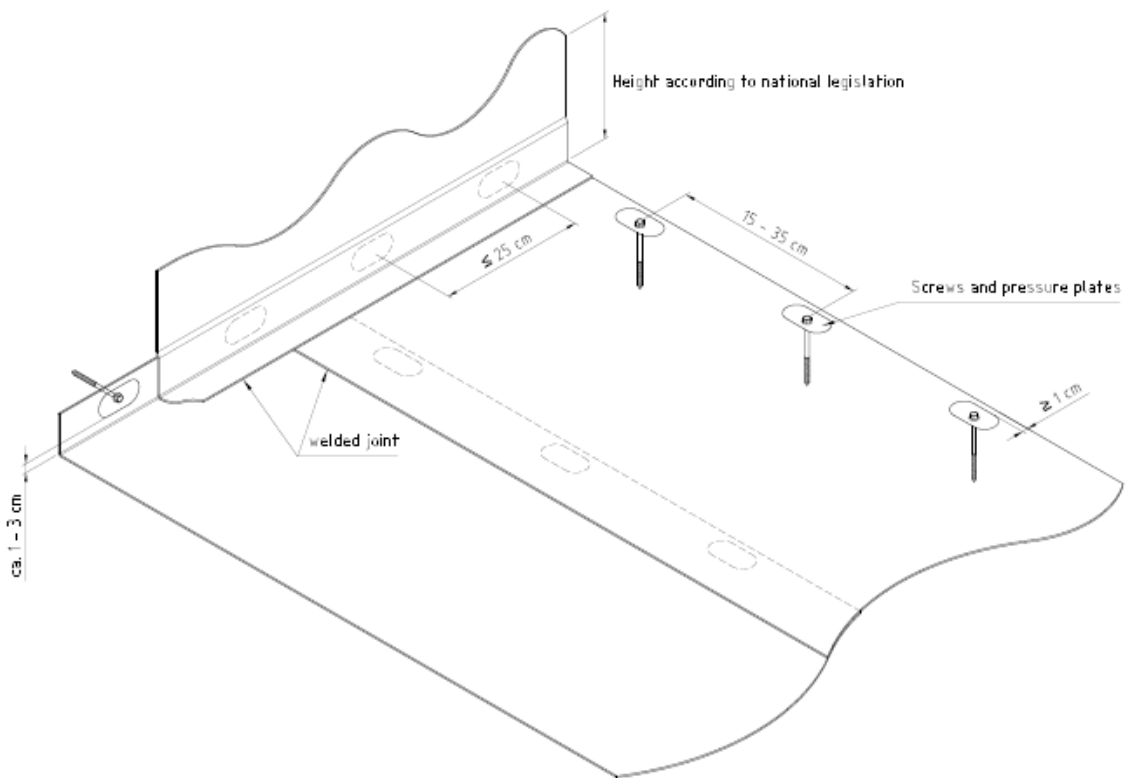
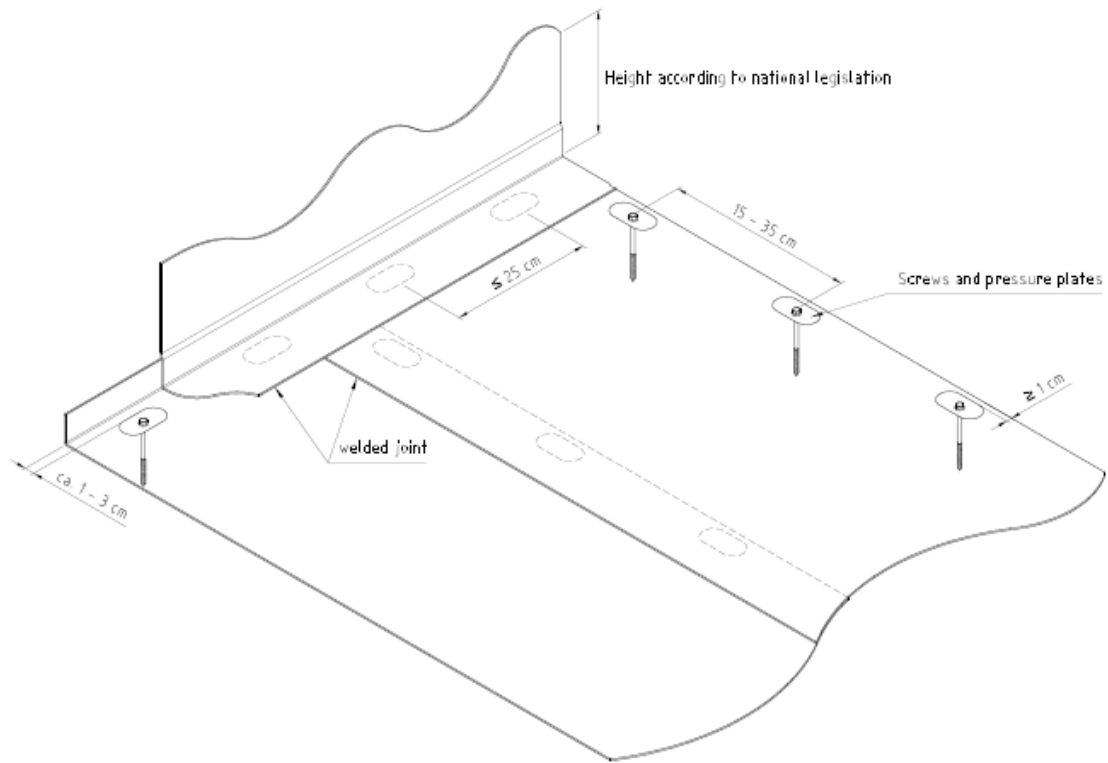

EVALON

Fastening system claimed and fastener spacing

Annex 10

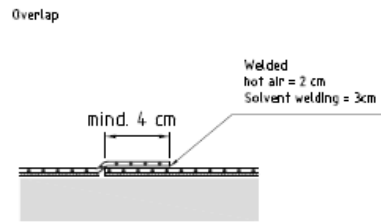

Case 6 : minimum overlapping in longitudinal area

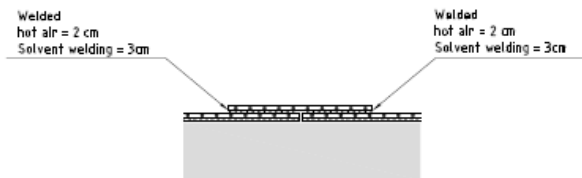

Case 7 : endjoints area

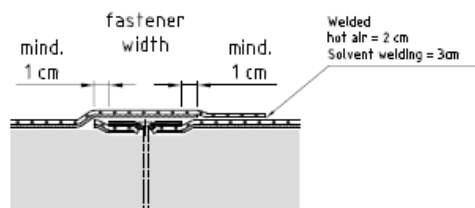

Case 8 : in longitudinal seam area

EVALON

Overlapping

Annex 11

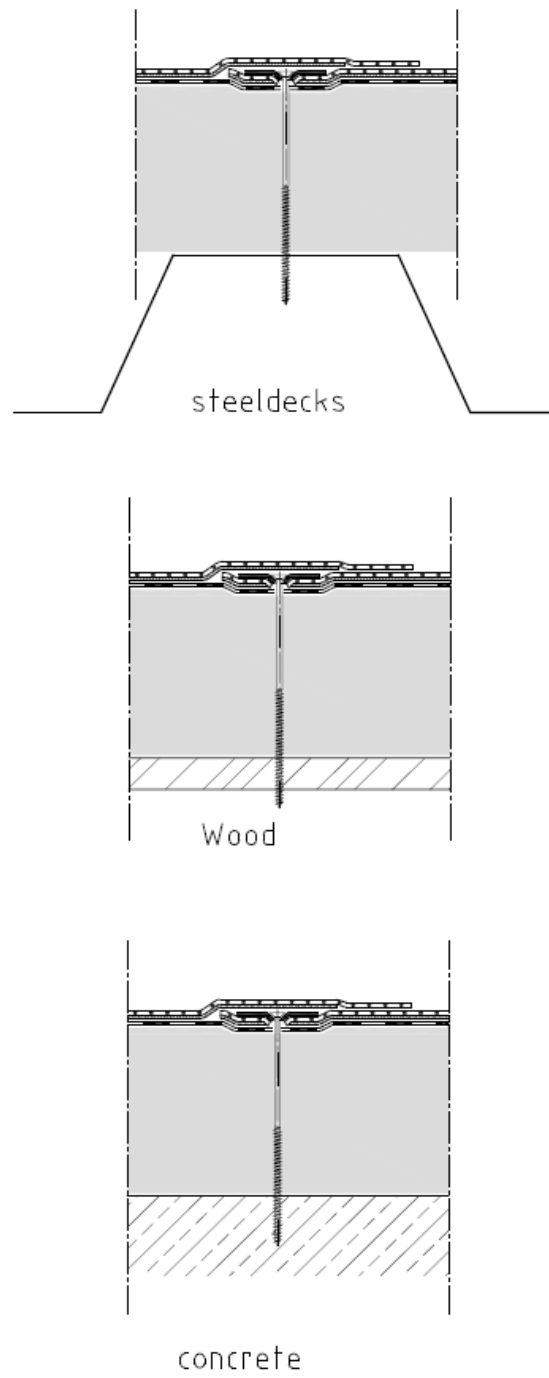

Case 10 : fixing into different substructure

Electronic copy of the ETA by DIBt: ETA-08/0112

EVALON

Different substrates

Annex 12



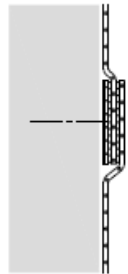
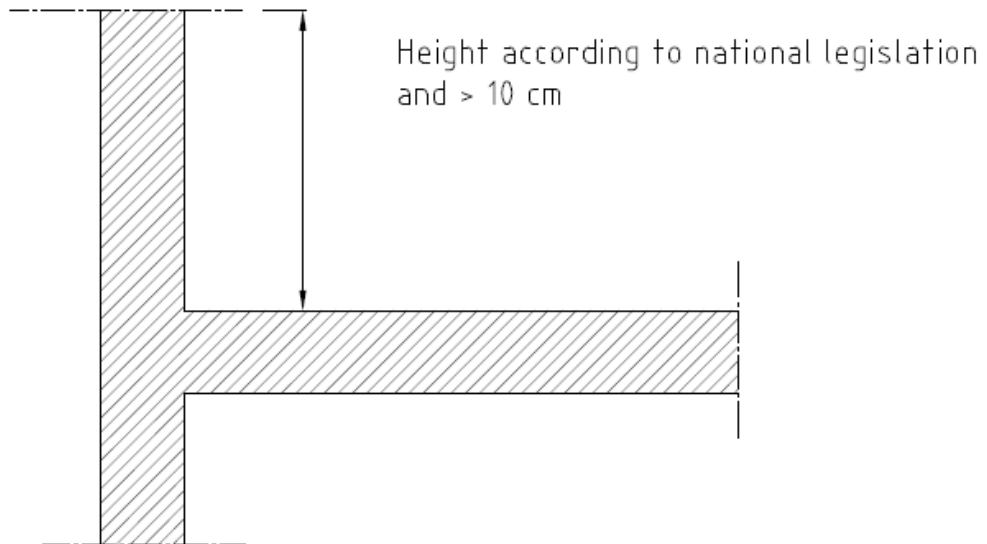

Case 11: intermediate fixing

Electronic copy of the ETA by DIBt: ETA-08/0112

EVALON

Intermediate fixing

Annex 13

**aiwitra**  
wall flashing profile

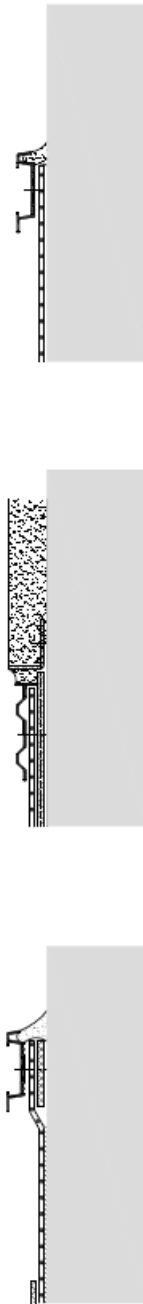

Case 12 : wall flashing with rigid wall flashing profiles

EVALON

Wall flashing

Annex 14

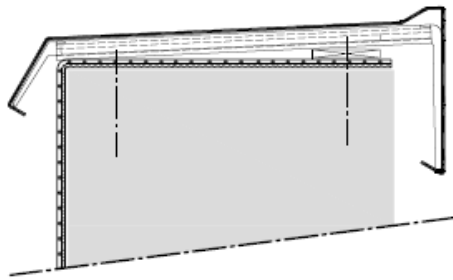

Example : wall cappings

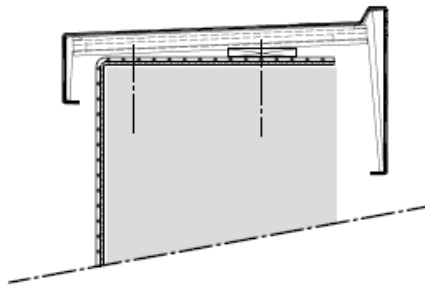
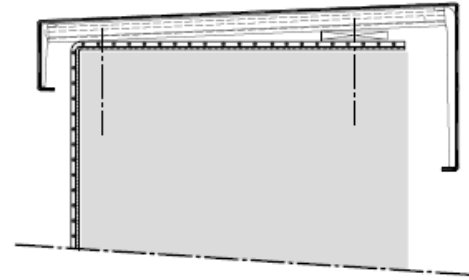

Example : coated metal sheet border profile

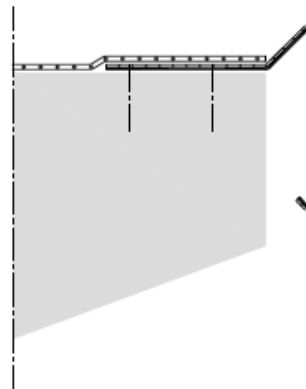

Case 13.1 : wall cappings and border profile

Electronic copy of the ETA by DIBt: ETA-08/0112

EVALON

Clappings and border profiles

Annex 15

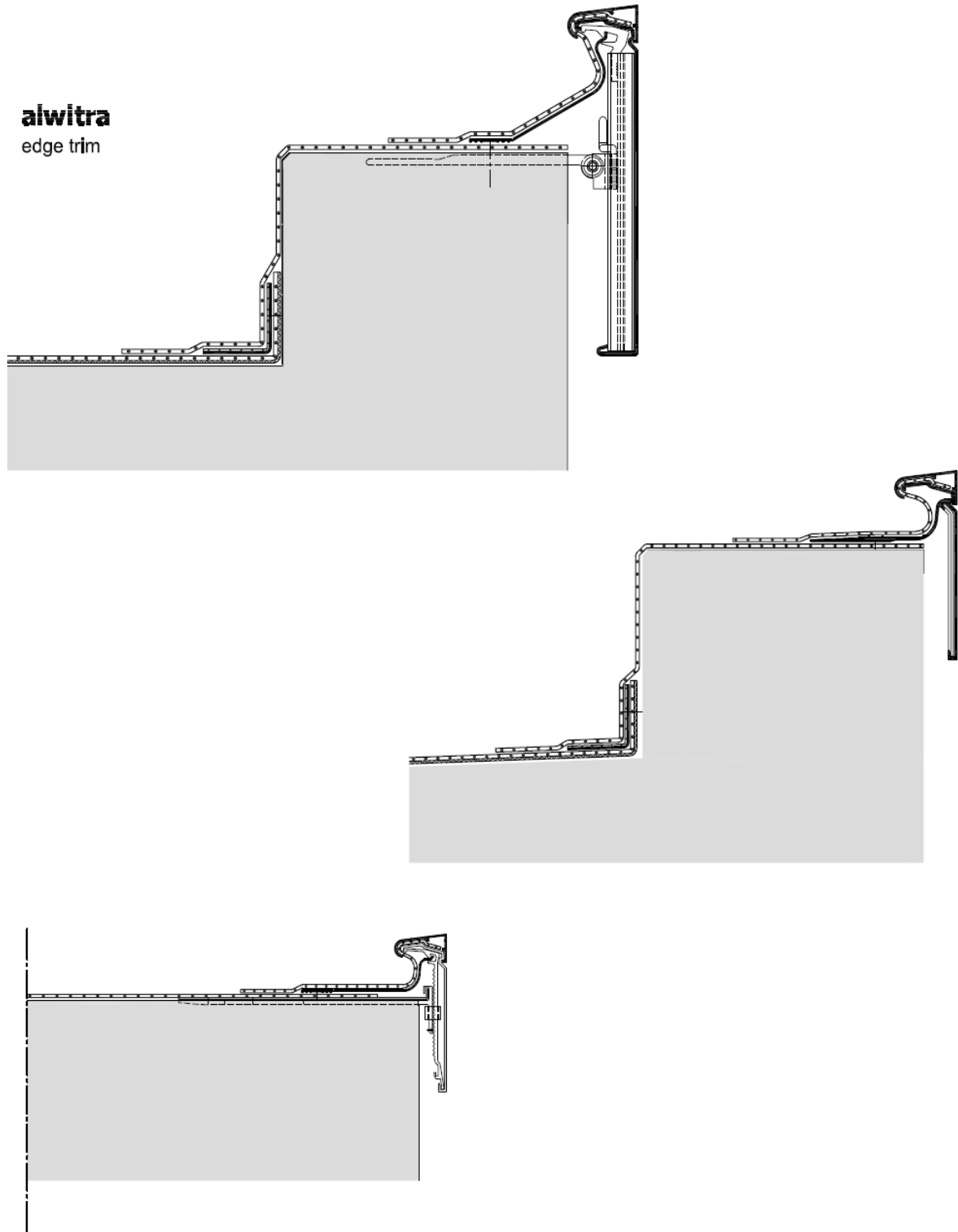

Electronic copy of the ETA by DIBt: ETA-08/0112

EVALON	Annex 16
Edge trim	

**aiwitra**  
emergency overfall

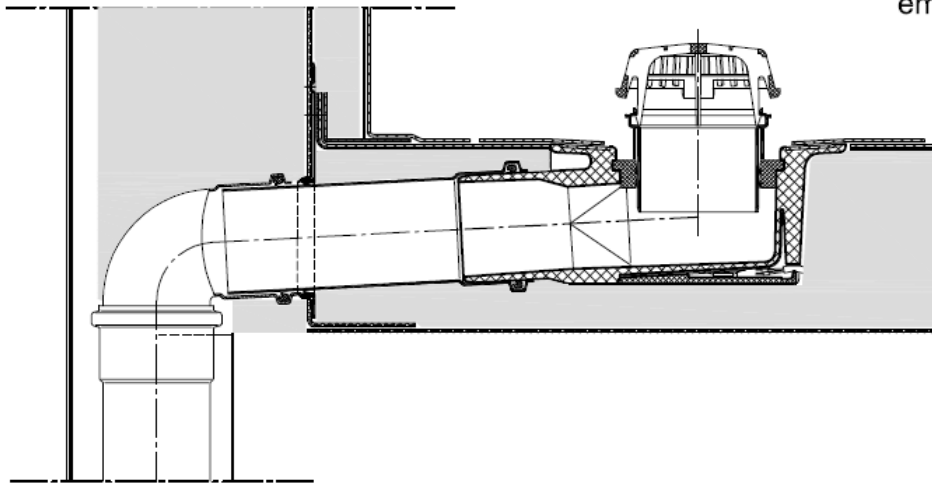

**aiwitra**  
rainwater outlet

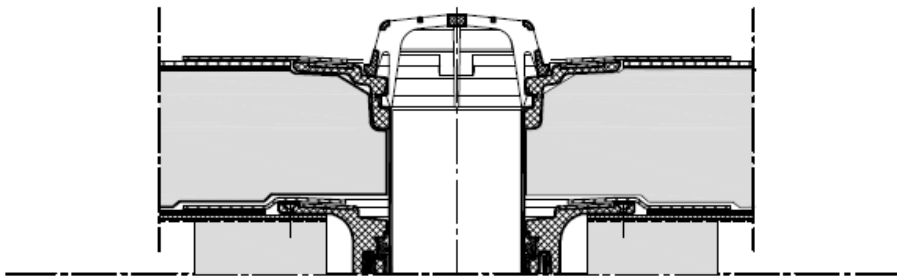

**aiwitra**  
water spout

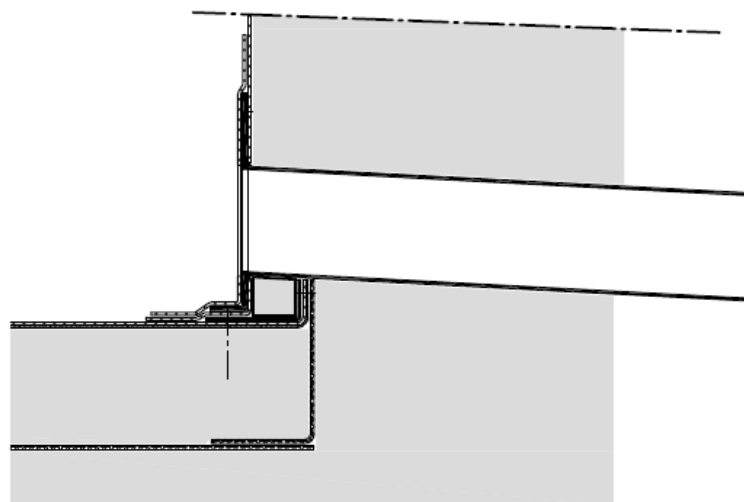

Case 14: emergency overfall, rainwater outlet and water spout

EVALON

Water outlets

Annex 17

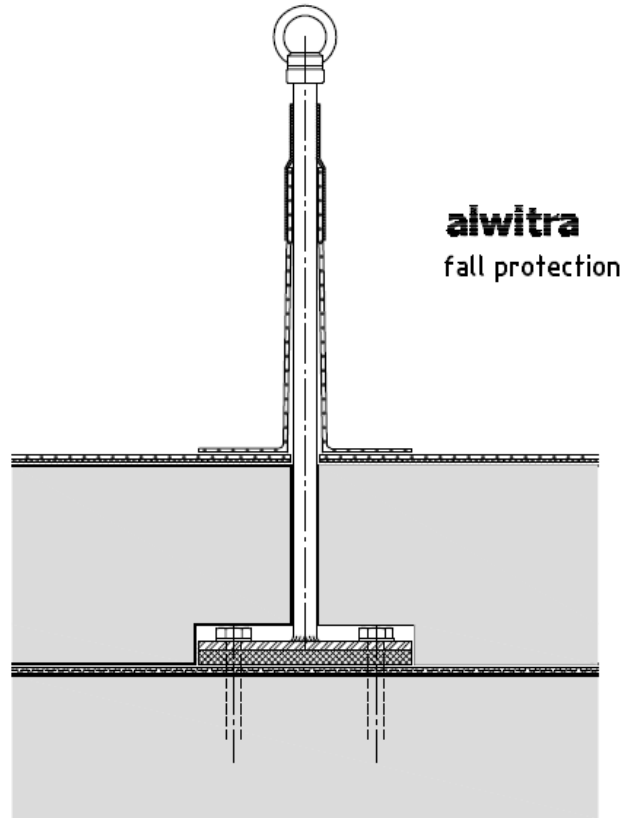

Case 15: fall protection

Electronic copy of the ETA by DIBt: ETA-08/0112

EVALON

Fall protection

Annex 18