



European Technical Approval ETA-09/0171

English translation prepared by DIBt - Original version in German language

Handelsbezeichnung <i>Trade name</i>	fischer termoz PN 8
Zulassungsinhaber <i>Holder of approval</i>	fischerwerke GmbH & Co. KG Weinhalde 14-18 72178 Waldachtal DEUTSCHLAND
Zulassungsgegenstand und Verwendungszweck <i>Generic type and use of construction product</i>	Nageldübel zur Verankerung von außenseitigen Wärmedämm- Verbundsystemen mit Putzschicht in Beton und Mauerwerk <i>Nailed-in plastic anchor for fixing of external thermal insulation composite systems with rendering in concrete and masonry</i>
Geltungsdauer: <i>Validity:</i>	vom <i>from</i> 30 June 2013 bis <i>to</i> 30 June 2018
Herstellwerk <i>Manufacturing plant</i>	fischerwerke

Diese Zulassung umfasst
This Approval contains

15 Seiten einschließlich 6 Anhänge
15 pages including 6 annexes

Diese Zulassung ersetzt
This Approval replaces

ETA-09/0171 mit Geltungsdauer vom 30.06.2010 bis 10.07.2014
ETA-09/0171 with validity from 30.06.2010 to 10.07.2014

I LEGAL BASES AND GENERAL CONDITIONS

- 1 This European technical approval is issued by Deutsches Institut für Bautechnik in accordance with:
 - Council Directive 89/106/EEC of 21 December 1988 on the approximation of laws, regulations and administrative provisions of Member States relating to construction products¹, modified by Council Directive 93/68/EEC² and Regulation (EC) N° 1882/2003 of the European Parliament and of the Council³;
 - *Gesetz über das In-Verkehr-Bringen von und den freien Warenverkehr mit Bauprodukten zur Umsetzung der Richtlinie 89/106/EWG des Rates vom 21. Dezember 1988 zur Angleichung der Rechts- und Verwaltungsvorschriften der Mitgliedstaaten über Bauprodukte und anderer Rechtsakte der Europäischen Gemeinschaften (Bauproduktengesetz - BauPG) vom 28. April 1998⁴, as amended by Article 2 of the law of 8 November 2011⁵;*
 - Common Procedural Rules for Requesting, Preparing and the Granting of European technical approvals set out in the Annex to Commission Decision 94/23/EC⁶;
 - Guideline for European technical approval of "Plastic anchors for fixing of external thermal insulation composite systems with rendering", ETAG 014.
- 2 Deutsches Institut für Bautechnik is authorized to check whether the provisions of this European technical approval are met. Checking may take place in the manufacturing plant. Nevertheless, the responsibility for the conformity of the products to the European technical approval and for their fitness for the intended use remains with the holder of the European technical approval.
- 3 This European technical approval is not to be transferred to manufacturers or agents of manufacturers other than those indicated on page 1, or manufacturing plants other than those indicated on page 1 of this European technical approval.
- 4 This European technical approval may be withdrawn by Deutsches Institut für Bautechnik, in particular pursuant to information by the Commission according to Article 5(1) of Council Directive 89/106/EEC.
- 5 Reproduction of this European technical approval including transmission by electronic means shall be in full. However, partial reproduction can be made with the written consent of Deutsches Institut für Bautechnik. In this case partial reproduction has to be designated as such. Texts and drawings of advertising brochures shall not contradict or misuse the European technical approval.
- 6 The European technical approval is issued by the approval body in its official language. This version corresponds fully to the version circulated within EOTA. Translations into other languages have to be designated as such.

¹ Official Journal of the European Communities L 40, 11 February 1989, p. 12
² Official Journal of the European Communities L 220, 30 August 1993, p. 1
³ Official Journal of the European Union L 284, 31 October 2003, p. 25
⁴ *Bundesgesetzblatt Teil I 1998*, p. 812
⁵ *Bundesgesetzblatt Teil I 2011*, p. 2178
⁶ Official Journal of the European Communities L 17, 20 January 1994, p. 34

II SPECIFIC CONDITIONS OF THE EUROPEAN TECHNICAL APPROVAL

1 Definition of product and intended use

1.1 Definition of the construction product

The fischer nailed-in anchor termoz PN 8 consists of a plastic sleeve made of polypropylene, a plate and an accompanying specific nail made of glass fibre reinforced polyamide.

The anchor may in addition be combined with the anchor plates DT 90, DT 110 and DT 140.

The installed anchor is shown in Annex 1.

1.2 Intended use

The anchor is intended to be used for anchorages for which requirements for safety in use in the sense of the Essential Requirement 4 of Council Directive 89/106/EEC shall be fulfilled and failure of anchorages made with these products would cause low risk to human life. The anchor is to be used only as multiple fixing for the anchorage of bonded thermal insulation composite systems (ETICS) according to ETAG 004 in concrete and masonry. The base material shall consist of reinforced or unreinforced normal weight concrete of strength class C12/15 at minimum and C50/60 at maximum according to EN 206-1:2000-12 or of masonry walls according to Annex 4.

The anchor may only be used for transmission of wind suction loads and shall not be used for the transmission of dead loads of the thermal insulation composite system. The dead loads have to be transmitted by the bonding of the thermal insulation composite system.

The provisions made in this European technical approval are based on an assumed working life of the anchor of 25 years. The indications given on the working life cannot be interpreted as a guarantee given by the producer, but are to be regarded only as a means for choosing the right products in relation to the expected economically reasonable working life of the works.

2 Characteristics of the product and methods of verification

2.1 Characteristics of the product

The anchor corresponds to the drawings and information given in Annex 2. The characteristic material values, dimensions and tolerances of the anchor not given in these Annexes shall correspond to the respective values laid down in the technical documentation⁷ of this European technical approval.

The characteristic values for the design of the anchorages are given in Annex 4.

Each anchor is at least to be marked with the type, the works symbol, the anchor size and the length of the anchor.

The minimum anchorage depth shall be marked.

The anchor shall only be packaged and supplied as a complete unit.

In addition to the specific clauses relating to dangerous substances contained in this European technical approval, there may be other requirements applicable to the products falling within its scope (e.g. transposed European legislation and national laws, regulations and administrative provisions). In order to meet the provisions of the Construction Products Directive, these requirements need also to be complied with, when and where they apply.

⁷ The technical documentation of this European technical approval is deposited at the Deutsches Institut für Bautechnik and, as far as relevant for the tasks of the approved bodies involved in the attestation of conformity procedure, is handed over to the approved bodies.

2.2 Methods of verification

The assessment of the fitness of the anchor for the intended use in relation to the requirements for safety in use in the sense of the Essential Requirement 4 has been made in compliance with

- the Guideline for European technical approval of "Plastic Anchors for Fixing of External Thermal Insulation Composite Systems with Rendering", ETAG 014, based on the use categories A, B and C,
- the EOTA Technical Report TR 025 "Determination of point thermal transmittance of plastic anchors for the anchorage of external thermal insulation composite systems (ETICS)" and
- the EOTA Technical Report TR 026 "Evaluation of plate stiffness from plastic anchors for fixing of external thermal insulation composite systems with rendering (ETICS)".

3 Evaluation and attestation of conformity and CE marking

3.1 System of attestation of conformity

According to the decision 97/463/EG of the European Commission⁸ the system 2(ii) (referred to as system 2+) of attestation of conformity applies.

This system of attestation of conformity is defined as follows.

System 2+: Declaration of conformity of the product by the manufacturer on the basis of:

(a) Tasks for the manufacturer:

- (1) initial type-testing of the product;
- (2) factory production control;
- (3) testing of samples taken at the factory in accordance with a prescribed test plan.

(b) Tasks for the approved body:

- (4) certification of factory production control on the basis of:
 - initial inspection of factory and of factory production control;
 - continuous surveillance, assessment and approval of factory production control.

3.2 Responsibilities

3.2.1 Tasks of the manufacturer

3.2.1.1 Factory production control

The manufacturer shall exercise permanent internal control of production. All the elements, requirements and provisions adopted by the manufacturer shall be documented in a systematic manner in the form of written policies and procedures, including records of results performed. This production control system shall insure that the product is in conformity with this European technical approval.

The manufacturer may only use raw materials stated in the technical documentation of this European technical approval.

The factory production control shall be in accordance with the control plan which is part of the technical documentation of this European technical approval. The control plan is laid down in the context of the factory production control system operated by the manufacturer and deposited at Deutsches Institut für Bautechnik.⁹

The results of factory production control shall be recorded and evaluated in accordance with the provisions of the control plan.

⁸ Official Journal of the European Communities L 198 of 25.07.1997.

⁹ The control plan is a confidential part of the documentation of the European technical approval, but not published together with the ETA and only handed over to the approved body involved in the procedure of attestation of conformity. See section 3.2.2.

3.2.1.2 Other tasks of manufacturer

The manufacturer shall, on the basis of a contract, involve a body which is approved for the tasks referred to in section 3.1 in the field of anchors in order to undertake the actions laid down in section 3.2.2. For this purpose, the control plan referred to in sections 3.2.1.1 and 3.2.2 shall be handed over by the manufacturer to the approved body involved.

The manufacturer shall make a declaration of conformity, stating that the construction product is in conformity with the provisions of this European technical approval.

3.2.2 Tasks of approved bodies

The approved body shall perform

- the initial inspection of factory and of factory production control,
- continuous surveillance, assessment and approval of factory production control

in accordance with the provisions laid down in the control plan.

The approved body shall retain the essential points of its actions referred to above and state the results obtained and conclusions drawn in a written report.

The approved certification body involved by the manufacturer shall issue an EC certificate of conformity of the factory production control stating the conformity with the factory production control of this European technical approval.

In cases where the provisions of the European technical approval and its control plan are no longer fulfilled the certification body shall withdraw the certificate of conformity and inform Deutsches Institut für Bautechnik without delay.

3.3 CE marking

The CE marking shall be affixed on each packaging of the anchor. The letters "CE" shall be followed by the identification number of the approved certification body, where relevant, and be accompanied by the following additional information:

- the name and address of the producer (legal entity responsible for the manufacturer),
- the last two digits of the year in which the CE marking was affixed,
- the number of the EC certificate for the factory production control,
- the number of the European technical approval,
- the number of the guideline for European technical approval,
- use categories A, B, C.

4 Assumptions under which the fitness of the product for the intended use was favourably assessed

4.1 Manufacturing

The European technical approval is issued for the product on the basis of agreed data/information, deposited with Deutsches Institut für Bautechnik, which identifies the product that has been assessed and judged. Changes to the product or production process, which could result in this deposited data/information being incorrect, should be notified to Deutsches Institut für Bautechnik before the changes are introduced. Deutsches Institut für Bautechnik will decide whether or not such changes affect the European technical approval and consequently the validity of the CE marking on the basis of the European technical approval and if so whether further assessment or alterations to the European technical approval shall be necessary.

4.2 Design of anchorages

4.2.1 General

Fitness for the intended use of the anchor is given under the following conditions:

- The design of anchorages is carried out in compliance with ETAG 014 "Guideline for European technical approval of Plastic Anchors for Fixing of External Thermal Insulation Composite Systems with Rendering" under the responsibility of an engineer experienced in anchorages.
- Verifiable calculation notes and drawings shall be prepared taking account of the loads to be anchored, the nature and strength of the base materials, the thickness of insulation and the dimensions of the anchorage members as well as of the relevant tolerances.
- The anchor shall only be used for the transmission of wind suction loads. All other loads such as dead load and restraints shall be transmitted by the adhesion of the relevant external thermal insulation composite system.

Verification of stability of the external thermal insulation composite system including application of loads on the anchor and on the additional plate is not subject of this European technical approval.

4.2.2 Resistance

The characteristic values of the tension resistance of the anchor are given in Annex 4. If there is a difference in the characteristic values of the base material or a similar base material of use category B, C is supposed to be used; job-site tests according to 4.4 shall be carried out and the characteristic tension resistance shall be determined.

4.2.3 Characteristic values, spacing and dimensions of anchorage member

The minimum spacing and dimensions of anchorage member according to Annex 3, Table 5 shall be observed.

4.2.4 Displacement behaviour

The displacements are given in the following table.

Table 4.1: Displacements for termoz PN 8

Base material	Bulk density class ρ [kg/dm ³]	Minimum compressive strength f_b [N/mm ²]	Tension load N [kN]	Displacements $\delta_m(\mathbf{N})$ [mm]
Concrete C16/20 - C50/60 (EN 206-1)			0,15	0,2
Sand-lime solid brick, KS (e.g. acc. to DIN V 106 / EN 771-2)	≥ 1,8	12	0,20	0,2
Clay brick, Mz (e.g. acc. to DIN 105-100 / EN 771-1)	≥ 2,0	12	0,20	0,3
Vertically perforated sand-lime brick, KSL (e.g. acc. to DIN V 106 / EN 771-2)	≥ 1,4	12	0,15	0,4
Vertically perforated clay brick, HLZ (e.g. acc. to DIN 105-100 / EN 771-1)	≥ 1,0	12	0,15	0,2
Lightweight concrete hollow blocks, Hbl (e.g. acc. to DIN V 18151-100 / EN 771-3)	≥ 1,2	10	0,15	0,2

4.2.5 Point thermal transmittance according EOTA Technical Report TR 025

The point thermal transmittance (CHI-value) of the anchor according EOTA Technical Report TR 025 "Determination of point thermal transmittance of plastic anchors for the anchorage of external thermal insulation composite systems (ETICS)" is given in the following table for use category A, B, C respectively.

Table 4.2: Point thermal transmittance

Anchor type	Insulation thickness h_D [mm]	Point thermal transmittance χ [W/K]
termoz PN 8	60 - 180	0.000

4.2.6 Plate stiffness according EOTA Technical Report TR 026

The plate stiffness of the anchor according EOTA Technical Report TR 026 "Evaluation of plate stiffness from plastic anchors for fixing of external thermal insulation composite systems with rendering (ETICS)" is given in the following table.

Table 4.3: Plate stiffness

Anchor type	Diameter of the anchor plate [mm]	Load resistance of the anchor plate [kN]	Plate stiffness [kN/mm]
termoz PN 8	60	1,6	0,4

4.3 Installation of anchor

The fitness for use of the anchor can only be assumed if the following conditions of installation are met:

- Anchor installation carried out by appropriately qualified personnel under the supervision of the person responsible for technical matters on site.
- Use of the anchor only as supplied by the manufacturer without exchanging any component of the anchor.
- Anchor installation in accordance with the manufacturer's specifications and drawings using the tools indicated in this European technical approval.
- Checks before placing the anchor, to ensure that the characteristic values of the base material in which the anchor is to be placed, is identical with the values, which the characteristic loads apply for.
- Placing drill holes without damaging the reinforcement.
- Temperature during installation of the anchor ≥ 0 °C.
- Exposure to UV due to solar radiation of the anchor not protected by rendering ≤ 6 weeks.

4.4 Job site tests

4.4.1 General

The characteristic tension resistance of the anchor may be determined by means of job site pull-out tests carried out on the material actually used, if a characteristic resistance of the base material does not exist (for example masonry made of other solid masonry units, hollow or perforated bricks and hollow blocks).

The characteristic resistance of the anchor shall be determined by carrying out at least 15 centric tension load pull-out tests on site. These tests are also possible under the same conditions in a laboratory.

Execution and evaluation of the tests as well as the issue of the test report and the determination of the characteristic resistance should be under the responsibility of approved testing laboratories or the supervision of the person responsible for the execution of the works on site.

Number and position of the anchors to be tested shall be adapted to the relevant special conditions of the site and, for example, to be increased in the case of hidden and larger areas, such that reliable information about the characteristic resistance of the anchor in the base material in question can be derived. The tests shall take into account the most unfavourable conditions of the practical execution.

4.4.2 Assembly

The anchor to be tested shall be installed (e.g. preparation of drill hole, drilling tool to be used, drill bit) and the spacing and the edge distances shall be in the same way as planned for the fixing of the external thermal insulation composite system.

Depending on the drilling tool and according to ISO 5468, hard metal hammer-drill bits or hard metal percussion drill bits, respectively, shall be used. The cutting diameter shall be at the upper tolerance limit.

4.4.3 Execution of test

The test rig used for the pull-out tests shall provide a continuous slow increase of the load, controlled by a calibrated load cell. The load shall apply perpendicular to the surface of the base material and shall be transmitted to the anchor via a hinge. The reaction forces shall be transmitted into the base material at a distance of at least 15 cm from the anchor. The load shall be increased continuously in a way that the ultimate load is reached after about 1 minute. The load is measured when the ultimate load (N_1) is achieved.

4.4.4 Test report

The test report shall include all information necessary to assess the resistance of the tested anchor. It shall be included in the construction dossier.

The minimum data required are:

- Construction site, owner of building; date and location of the tests, air temperature; type of member (ETICS) to be fixed,
- base material (type of brick, strength class, all dimensions of bricks, mortar group); Visual assessment of masonry (flush joints, joint clearance, regularity),
- Plastic anchor and nail; value of the cutting diameter of hard metal hammer-drill bits, measured before and after drilling,
- Test rig; results of tests including the indication of value N_1 ,
- Tests carried out or supervised by; signature.

4.4.5 Evaluation of test results

The characteristic resistance N_{Rk1} is obtained from the measured values of N_1 as follows:

$$N_{Rk1} = 0,6 \cdot N_1 \leq 1,5 \text{ kN}$$

$$N_1 = \text{the mean value of the five smallest measured values at the ultimate load}$$

5 Indications for the manufacturer

5.1 Responsibility of the manufacturer

It is in the responsibility of the manufacturer to ensure that the information on the specific conditions according to 1 and 2 including Annexes referred to 4 is given to those who are concerned. This information may be made by reproduction of the respective parts of the European technical approval. In addition, all installation data shall be shown clearly on the packaging and/or on an enclosed instruction sheet, preferably using illustrations.

The minimum data required are:

- base material for the intended use,
- drill bit diameter,
- maximum thickness of the ETICS,
- minimum effective anchorage depth,
- minimum hole depth,
- information on the installation procedure,
- identification of the manufacturing batch.

All data shall be presented in a clear and explicit form.

5.2 Packaging, transport and storage

The anchor shall only be packaged and supplied as a complete unit.

The anchor shall be stored under normal climatic conditions in its original light-proof packaging. Before installation, it shall not be extremely dried nor frozen.

Andreas Kummerow
p. p. Head of Department

beglaubigt:
Bürger

termoz PN 8

External Thermal Insulation Composite System

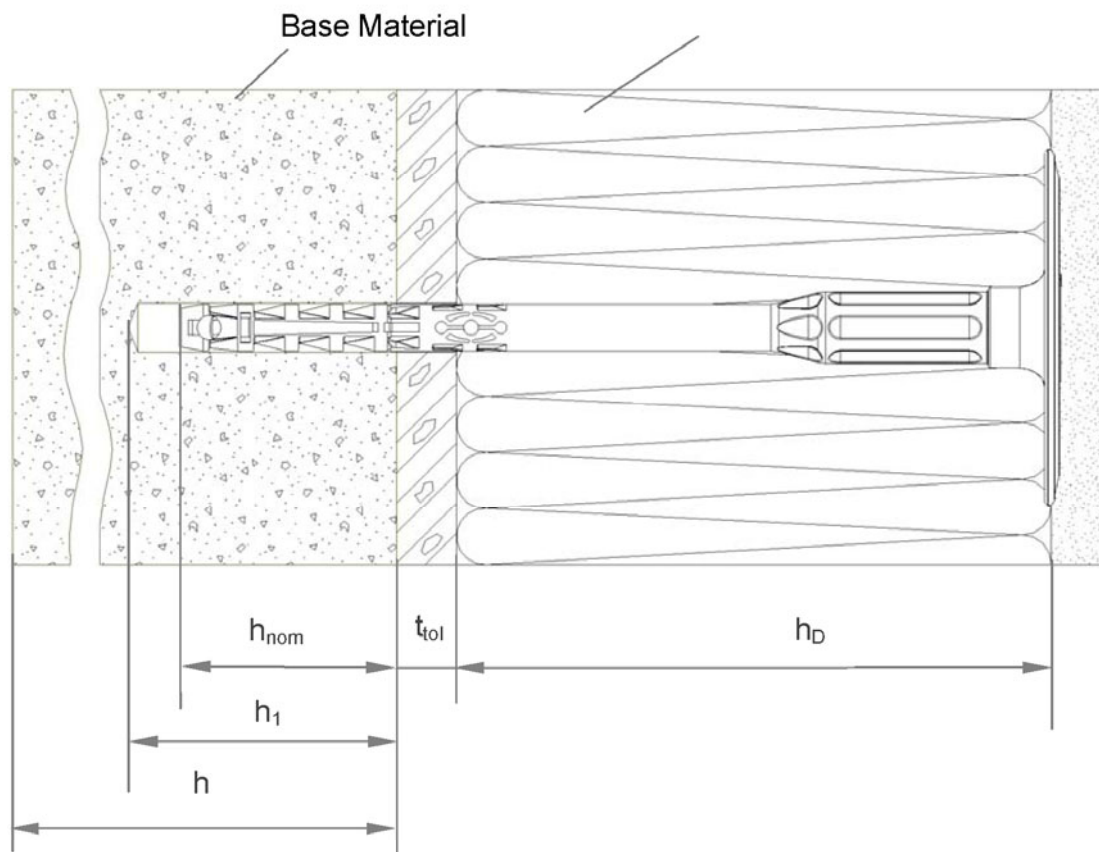

Intended Use

Fixing of external thermal insulation composite systems in concrete and masonry

Legend

- h_{nom} = Overall plastic anchor embedment depth in the base material
- h_1 = Depth of drilled hole to deepest point
- h = Thickness of member (wall)
- h_D = Thickness of insulation material

fischer termoz PN 8

Intended Use

Annex 1

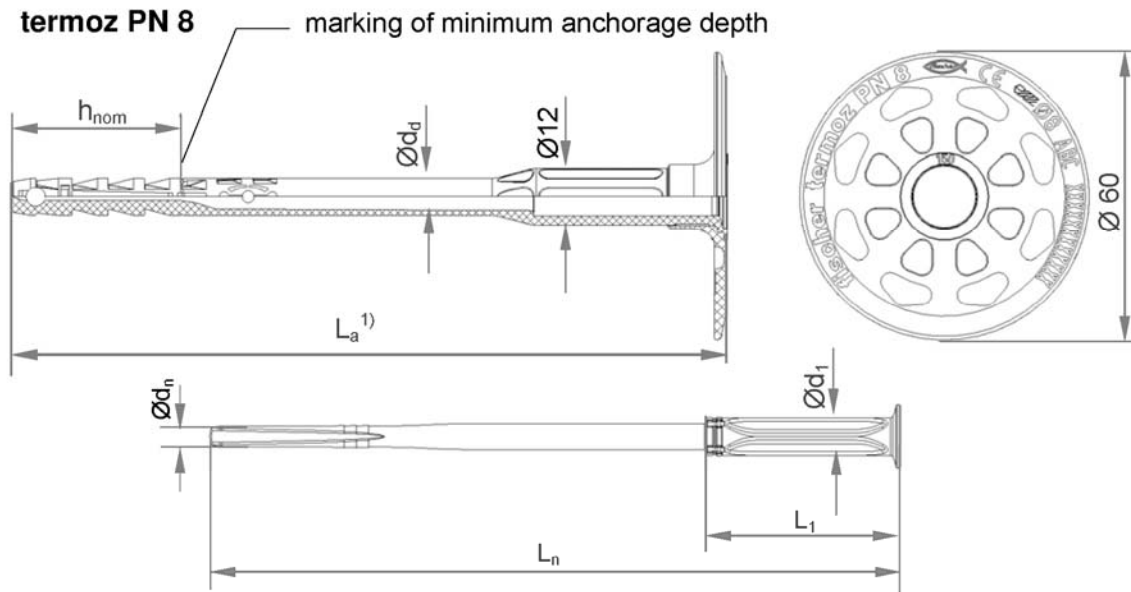

- 1) Various length of the anchors are permissible:
 termoz PN 8 : $L_{a \text{ min}} \geq 110 \text{ mm}$; $L_{a \text{ max}} \leq 230 \text{ mm}$
 $L_a = \text{length of accompanying specific nail } L_n + 5 \text{ mm}$

Determination of maximum thickness of insulation: $h_D = L_a - h_{\text{nom}} - t_{\text{tol}}$
 e.g. for termoz PN 8x150:
 $L_a = 148 \text{ mm}$, $h_{\text{nom}} = 35 \text{ mm}$, $t_{\text{tol}} = 10$ $h_D = 148 - 35 - 10 \approx 100 \text{ mm}$

Table 1: Marking





Anchor type	termoz PN 8
Plate diameter	Ø 60
Works symbol	 or  or blank
Size of anchor	Ø 8
Length of anchor	L_a
Example	fischer (optional) termoz PN 8  or  or blank CE (optional)  Ø 8 (optional) ABC (optional) XXXXX= various additional marking allowed

Table 2: Dimensions

Anchor type	Anchor sleeve		Accompanying specific plastic nail		
	Ø d_d [mm]	h_{nom} [mm]	Ø d_n [mm]	L_1 [mm]	Ø d_1 [mm]
termoz PN 8	8	35	4,4	40	8

fischer termoz PN 8

Marking
Dimensions

Annex 2

Table 3: Materials

Designation	Material
Anchor sleeve	PP, colour: grey
Specific plastic nail	PA 6 GF 50, colour: natur
Slip-on plate	PA6, GF 30 or PA6, GF 35, colour: grey, orange, red, green, yellow, blue

Table 4: Installation parameters

Anchor type				termoz PN 8
Drill hole diameter	d_0	=	[mm]	8
Cutting diameter of drill bit	d_{cut}	≤	[mm]	8,45
Depth of drilled hole to deepest point	h_1	≥	[mm]	45
Overall plastic anchor embedment depth in the base material	h_{nom}	≥	[mm]	35

Table 5: Minimum distances and dimensions

				termoz PN 8
Minimum thickness of member	h	=	[mm]	100
Minimum allowable spacing	s_{min}	=	[mm]	100
Minimum allowable edge distance	c_{min}	=	[mm]	100

Scheme of distances and spacing

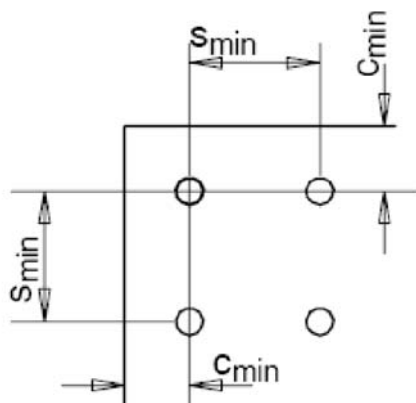

fischer termoz PN 8

Materials parameters, distances and spacing

Annex 3

Table 6: Characteristic resistance N_{Rk} in [kN] to tension loads for single anchor

Base material	Bulk density class ρ [kg/dm ³]	Minimum compressive strength f_b [N/mm ²]	Remarks	Drilling method ²⁾	Characteristic resistance N_{Rk} to tension loads [kN]
					termoz PN 8
Concrete \geq C12/15	-	-	EN 206	H	0,5
Concrete \geq C16/20	-	-	EN 206	H	0,5
Concrete C50/60	-	-	EN 206	H	0,5
Sand-lime solid bricks e.g. acc. to DIN V106 / EN 771-2, KS	$\geq 1,8$	12	Cross section reduced up to 15% by perforation vertically to the resting area	H	0,6
Clay bricks e.g. acc. to DIN 105-100 / EN 771-1, Mz	$\geq 2,0$	12	Cross section reduced up to 15% by perforation vertically to the resting area	R	0,6
Vertically perforated sand-lime bricks e.g. acc. to DIN V106 / EN 771-2, KSL	$\geq 1,4$	12	Cross section reduced more than 15% by perforation vertically to the resting area exterior web thickness ≥ 23 mm	H	0,4
Vertically perforated clay bricks e.g. acc. to DIN 105-100 / EN 771-1, HLz	$\geq 1,0$	12	Cross section reduced more than 15% and less than 50% by perforation vertically to the resting area exterior web thickness ≥ 12 mm	R	0,4
Leightweight concrete hollow blocks e.g. acc. to DIN V 18151-100 / EN 771-3, Hbl	$\geq 1,2$	10	See Annex 5	H	0,5
Partial safety factor for anchor resistance ¹⁾				γ_M	2,0

1) In absence of other national regulations

2) H = Hammer drilling, R = Rotary drilling

fischer termoz PN 8

Characteristic resistance

Annex 4

**Table 7: Geometry of Lightweight concrete hollow blocks (Hbl)
according to DIN V 18151-100 / EN 771-3**

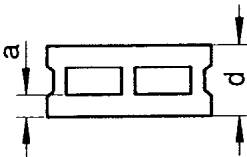
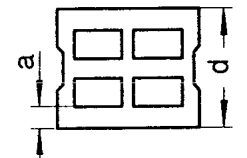
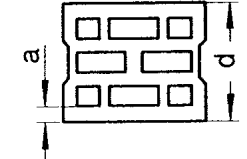
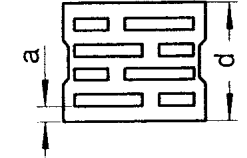
Geometry	Thickness of brick d [mm]	Outer web in longitudinal direction a [mm]	Anchor type termoz PN 8
	175	50	●
	240 300	50	●
	240 300 365	38	●
	240 300 365	38	●

The anchor shall be placed in a way that the spreading part is anchored in the web of the brick.

fischer termoz PN 8

Geometry of lightweight concrete hollow blocks (Hbl)

Annex 5

Slip-on plates DT 90, DT 110 and DT 140

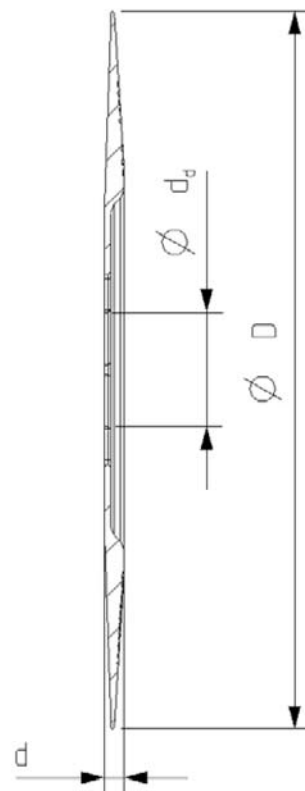
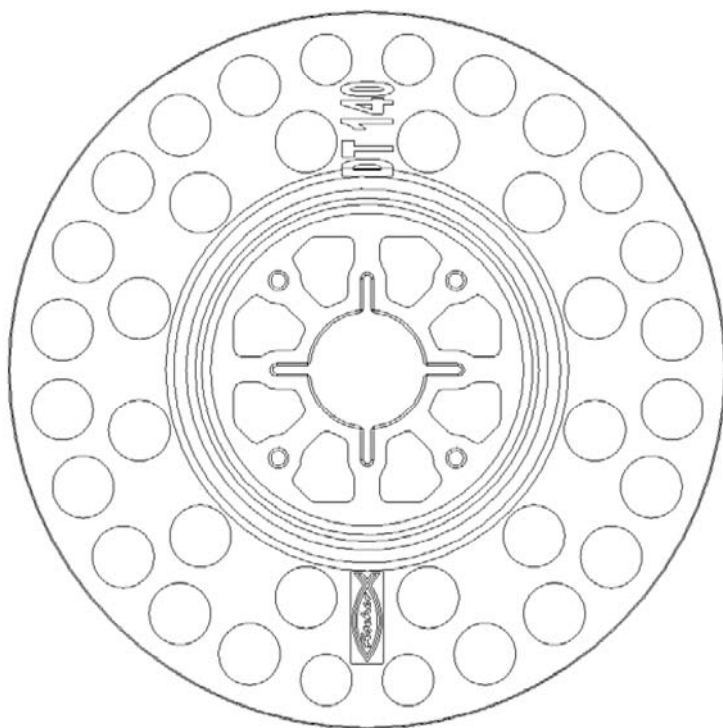

Table 8: Slip-on plates, diameters and material

Slip-on plate	Ø D [mm]	Ø d _d [mm]	d [mm]	Material
DT 90	90	22,5	3,9	PA 6 GF
DT 110	110	22,5	3,9	PA 6 GF
DT 140	140	22,5	3,9	PA 6 GF

fischer termoz PN 8

Slip-on plates
combined with termoz PN 8

Annex 6