

European Technical Approval ETA-09/0313

English translation prepared by DIBt - Original version in German language

Handelsbezeichnung <i>Trade name</i>	SMK Nageldübel MND 6 <i>SMK Nail anchor MND 6</i>
Zulassungsinhaber <i>Holder of approval</i>	SMK Meister GmbH u. Co. KG Lombacher Straße 53 72293 Glatten
Zulassungsgegenstand und Verwendungszweck	Metалldübel aus galvanisch verzinktem und nichtrostendem Stahl in den Größen 6x45, 6x50 und 6x70 für die Verwendung als Mehrfachbefestigung von nichttragenden Systemen in Beton
<i>Generic type and use of construction product</i>	<i>Metal anchor made of galvanised steel and stainless steel of size 6x45, 6x50 and 6x70 for multiple use for non-structural applications in concrete</i>
Geltungsdauer: <i>Validity:</i>	vom <i>from</i> bis <i>to</i>
	4 June 2013 4 June 2018
Herstellwerk <i>Manufacturing plant</i>	SMK Meister GmbH u. Co. KG Lombacher Straße 53 72293 Glatten

Diese Zulassung umfasst
This Approval contains

11 Seiten einschließlich 4 Anhänge
11 pages including 4 annexes

Diese Zulassung ersetzt
This Approval replaces

ETA-09/0313 mit Geltungsdauer vom 15.08.2012 bis 11.12.2014
ETA-09/0313 with validity from 15.08.2012 to 11.12.2014

I LEGAL BASES AND GENERAL CONDITIONS

- 1 This European technical approval is issued by Deutsches Institut für Bautechnik in accordance with:
 - Council Directive 89/106/EEC of 21 December 1988 on the approximation of laws, regulations and administrative provisions of Member States relating to construction products¹, modified by Council Directive 93/68/EEC² and Regulation (EC) N° 1882/2003 of the European Parliament and of the Council³;
 - *Gesetz über das In-Verkehr-Bringen von und den freien Warenverkehr mit Bauprodukten zur Umsetzung der Richtlinie 89/106/EWG des Rates vom 21. Dezember 1988 zur Angleichung der Rechts- und Verwaltungsvorschriften der Mitgliedstaaten über Bauprodukte und anderer Rechtsakte der Europäischen Gemeinschaften (Bauproduktengesetz - BauPG) vom 28. April 1998⁴, as amended by Article 2 of the law of 8 November 2011⁵;*
 - Common Procedural Rules for Requesting, Preparing and the Granting of European technical approvals set out in the Annex to Commission Decision 94/23/EC⁶;
 - Guideline for European technical approval of "Metal anchors for use in concrete - Part 6: Anchors for multiple use for non-structural applications", ETAG 001-06.
- 2 Deutsches Institut für Bautechnik is authorized to check whether the provisions of this European technical approval are met. Checking may take place in the manufacturing plant. Nevertheless, the responsibility for the conformity of the products to the European technical approval and for their fitness for the intended use remains with the holder of the European technical approval.
- 3 This European technical approval is not to be transferred to manufacturers or agents of manufacturers other than those indicated on page 1, or manufacturing plants other than those indicated on page 1 of this European technical approval.
- 4 This European technical approval may be withdrawn by Deutsches Institut für Bautechnik, in particular pursuant to information by the Commission according to Article 5(1) of Council Directive 89/106/EEC.
- 5 Reproduction of this European technical approval including transmission by electronic means shall be in full. However, partial reproduction can be made with the written consent of Deutsches Institut für Bautechnik. In this case partial reproduction has to be designated as such. Texts and drawings of advertising brochures shall not contradict or misuse the European technical approval.
- 6 The European technical approval is issued by the approval body in its official language. This version corresponds fully to the version circulated within EOTA. Translations into other languages have to be designated as such.

¹ Official Journal of the European Communities L 40, 11 February 1989, p. 12
² Official Journal of the European Communities L 220, 30 August 1993, p. 1
³ Official Journal of the European Union L 284, 31 October 2003, p. 25
⁴ *Bundesgesetzblatt Teil I 1998*, p. 812
⁵ *Bundesgesetzblatt Teil I 2011*, p. 2178
⁶ Official Journal of the European Communities L 17, 20 January 1994, p. 34

II SPECIFIC CONDITIONS OF THE EUROPEAN TECHNICAL APPROVAL

1 Definition of product and intended use

1.1 Definition of the construction product

The SMK nail anchor MND 6 of size 6x45, 6x50 and 6x70 is an anchor made of zinc-plated steel or stainless steel which is placed into a drilled hole and anchored by load-controlled expansion. An illustration of the product and intended use is given in Annex 1.

1.2 Intended use

The anchor is intended to be used for anchorages for which requirements for safety in use in the sense of the Essential Requirements 4 of Council Directive 89/106 EEC shall be fulfilled and failure of the fixture represents an immediate risk to human life. The anchor is to be used only for multiple use for non-structural applications. The definition of multiple use according to the Member States is given in the informative Annex 1 of ETAG 001, Part 6.

The anchor may be used for anchorages with requirements related to resistance to fire.

The anchor is to be used only for anchorages subject to static or quasi-static loading in reinforced or unreinforced normal weight concrete of strength classes C20/25 at minimum and C50/60 at most according to EN 206-1:2000-12. It may be anchored in cracked or non-cracked concrete.

SMK nail anchor made of zinc-plated steel:

The anchor made of zinc-plated steel may only be used in structures subject to dry internal conditions.

SMK nail anchor made of stainless steel:

The anchor made of stainless steel may be used in structures subject to dry internal conditions and also in structures subject to external atmospheric exposure (including industrial and marine environment), or exposure in permanently damp internal conditions, if no particular aggressive conditions exist. Such particular aggressive conditions are e.g. permanent, alternating immersion in seawater or the splash zone of seawater, chloride atmosphere of indoor swimming pools or atmosphere with extreme chemical pollution (e.g. in desulphurization plants or road tunnels where de-icing materials are used).

The provisions made in this European technical approval are based on an assumed working life of the anchor of 50 years. The indications given on the working life cannot be interpreted as a guarantee given by the producer, but are to be regarded only as a means for choosing the right products in relation to the expected economically reasonable working life of the works.

2 Characteristics of the product and methods of verification

2.1 Characteristics of the product

The anchor corresponds to the drawings and provisions given in Annex 2. The characteristic material values, dimensions and tolerances of the anchor not given in Annex 2 shall correspond to the respective values laid down in the technical documentation⁷ of this European technical approval.

Regarding the requirements concerning safety in case of fire it is assumed that the anchor meets the requirements of class A1 in relation to reaction to fire in accordance with the stipulations of the Commission decision 96/603/EC, amended by 2000/605/EC.

The characteristic values for the design of anchorages are given in Annex 3. The characteristic values for the design of the anchorages regarding resistance to fire are given in Annex 3, Table 4. They are valid for use in a system that is required to provide a specific fire resistance class.

Each anchor is marked with the anchor identity and the anchor size according to Annex 2.

The anchor shall only be supplied as a complete unit.

2.2 Methods of verification

The assessment of fitness of the anchor for the intended use in relation to the requirements for safety in use in the sense of the Essential Requirements 4 has been made in accordance with the "Guideline for European technical approval of Metal Anchors for use in concrete", Part 1 "Anchors in general" and Part 6 "Anchors for multiple use for non-structural applications".

The assessment of the anchor for the intended use in relation to the requirements for resistance to fire has been made in accordance with the Technical Report TR 020 "Evaluation of anchorages in concrete concerning resistance to fire".

In addition to the specific clauses relating to dangerous substances contained in this European technical approval, there may be other requirements applicable to the products falling within its scope (e.g. transposed European legislation and national laws, regulations and administrative provisions). In order to meet the provisions of the Construction Products Directive, these requirements need also to be complied with, when and where they apply.

3 Evaluation and attestation of conformity and CE marking

3.1 System of attestation of conformity

According to the decision 97/161/EG of the European Commission⁸ the system 2(ii) (referred to as system 2+) of attestation of conformity applies.

This system of attestation of conformity is defined as follows:

System 2+: Declaration of conformity of the product by the manufacturer on the basis of:

- (a) Tasks for the manufacturer:
 - (1) initial type-testing of the product;
 - (2) factory production control;
 - (3) testing of samples taken at the factory in accordance with a prescribed test plan.

⁷ The technical documentation of this European technical approval is deposited at the Deutsches Institut für Bautechnik and, as far as relevant for the tasks of the approved bodies involved in the attestation of conformity procedure, is handed over to the approved bodies.

⁸ Official Journal of the European Communities L 67 of 03.02.1997

European technical approval

ETA-09/0313

Page 5 of 11 | 4 June 2013

English translation prepared by DIBt

(b) Tasks for the approved body:

(4) certification of factory production control on the basis of:

- initial inspection of factory and of factory production control;
- continuous surveillance, assessment and approval of factory production control.

Note: Approved bodies are also referred to as "notified bodies".

3.2 Responsibilities**3.2.1 Tasks for the manufacturer****3.2.1.1 Factory production control**

The manufacturer shall exercise permanent internal control of production. All the elements, requirements and provisions adopted by the manufacturer shall be documented in a systematic manner in the form of written policies and procedures, including records of results performed. This production control system shall insure that the product is in conformity with this European technical approval.

The manufacturer may only use initial / raw / constituent materials stated in the technical documentation of this European technical approval.

The factory production control shall be in accordance with the control plan which is part of the technical documentation of this European technical approval. The control plan is laid down in the context of the factory production control system operated by the manufacturer and deposited with Deutsches Institut für Bautechnik.⁹

The results of factory production control shall be recorded and evaluated in accordance with the provisions of the control plan.

3.2.1.2 Other tasks of manufacturer

The manufacturer shall, on the basis of a contract, involve a body which is approved for the tasks referred to in section 3.1 in the field of anchors in order to undertake the actions laid down in section 3.2.2. For this purpose, the control plan referred to in sections 3.2.1.1 and 3.2.2 shall be handed over by the manufacturer to the approved body involved.

The manufacturer shall make a declaration of conformity, stating that the construction product is in conformity with the provisions of this European technical approval.

3.2.2 Tasks for the approved bodies

The approved body shall perform the

- initial inspection of factory and of factory production control,
 - continuous surveillance, assessment and approval of factory production control,
- in accordance with the provisions laid down in the control plan.

The approved body shall retain the essential points of its actions referred to above and state the results obtained and conclusions drawn in a written report.

The approved certification body involved by the manufacturer shall issue an EC certificate of conformity of the factory production control stating the conformity with the provisions of this European technical approval.

In cases where the provisions of the European technical approval and its control plan are no longer fulfilled the certification body shall withdraw the certificate of conformity and inform Deutsches Institut für Bautechnik without delay.

⁹ The control plan is a confidential part of the European technical approval and only handed over to the approved body involved in the procedure of attestation of conformity. See section 3.2.2.

3.3 CE marking

The CE marking shall be affixed on each packaging of the anchor. The letters "CE" shall be followed by the identification number of the approved certification body, where relevant, and be accompanied by the following additional information:

- the name and address of the producer (legal entity responsible for the manufacture),
- the last two digits of the year in which the CE marking was affixed,
- the number of the EC certificate for the factory production control,
- the number of the European technical approval,
- the number of the guideline for European technical approval (ETAG 001-6),
- size.

4 Assumptions under which the fitness of the product for the intended use was favourably assessed

4.1 Manufacturing

The European technical approval is issued for the product on the basis of agreed data/information, deposited with the Deutsches Institut für Bautechnik, which identifies the product that has been assessed and judged. Changes to the product or production process, which could result in this deposited data/information being incorrect, should be notified to the Deutsches Institut für Bautechnik before the changes are introduced. Deutsches Institut für Bautechnik will decide whether or not such changes affect the approval and consequently the validity of the CE marking on the basis of the approval and if so whether further assessment or alterations to the approval shall be necessary.

4.2 Design of anchorages

The fitness of the anchor for the intended use is given under the following conditions:

The anchorages are designed in accordance with the "Guideline for European technical approval of Metal Anchors for Use in Concrete", Annex C, Method C under the responsibility of an engineer experienced in anchorages and concrete work.

The anchor is to be used only for multiple use for non-structural applications, the definition of multiple use according to the Member States is given in the informative Annex 1 of ETAG 001, Part 6.

Verifiable calculation notes and drawings are prepared taking account of the loads to be anchored.

The position of the anchor is indicated on the design drawings (e.g. position of the anchor relative to reinforcement or to supports).

The design of the fixture is such that in case of excessive slip or failure of one anchor the load can be transmitted to neighbouring anchors.

The design of anchorages under fire exposure has to consider the conditions given in the Technical Report TR 020 "Evaluation of anchorages in concrete concerning resistance to fire". The relevant characteristic values are given in Annex 3, Table 4. The design method covers anchors with a fire attack from one side only. If the fire attack is from more than one side, the design method may be taken only, if the edge distance of the anchor is $c \geq 300$ mm.

4.3 Installation of anchors

The fitness for use of the anchor can only be assumed if the anchor is installed as follows:

- anchor installation carried out by appropriately qualified personnel and under the supervision of the person responsible for technical matters of the site,
- use of the anchor only as supplied by the manufacturer,
- anchor installation in accordance with the manufacturer's specifications and drawings and using the appropriate tools,
- checks before placing the anchor to ensure that the strength class of the concrete in which the anchor is to be placed is in the range given and is not lower than that of the concrete to which the characteristic loads apply,
- check of concrete being well compacted, e.g. without significant voids,
- edge distances and spacing not less than the specified values without minus tolerances,
- positioning of the drill holes without damaging the reinforcement,
- in case of aborted hole: new drilling at a minimum distance away of twice the depth of the aborted hole or smaller distance if the aborted drill hole is filled with high strength mortar,
- cleaning of the hole,
- anchor installation such that the effective setting depth is complied with. This compliance is ensured, if the maximum admissible thickness of the fixture according to Annex 2 is kept.

5 Responsibility of the manufacturer

The manufacturer is responsible to ensure that the information on the specific conditions according to 1 and 2 including Annexes referred to as well as sections 4.2 and 4.3 is given to those who are concerned. This information may be made by reproduction of the respective parts of the European technical approval. In addition all installation data shall be shown clearly on the package and/or on an enclosed instruction sheet, preferably using illustration(s).

The minimum data required are:

- drill bite diameter,
- minimum effective anchorage depth,
- minimum hole depth,
- maximum thickness of fixture for the anchor type,
- information on the installation procedure, preferably by means of an illustration,
- reference to any special installation equipment needed,
- identification of the manufacturing batch.

All data shall be presented in a clear and explicit form.

Andreas Kummerow
p. p. Head of Department

beglaubigt:
Tempel

Only for multiple use for non-structural applications
according to ETAG 001, Part 6, Annex 1

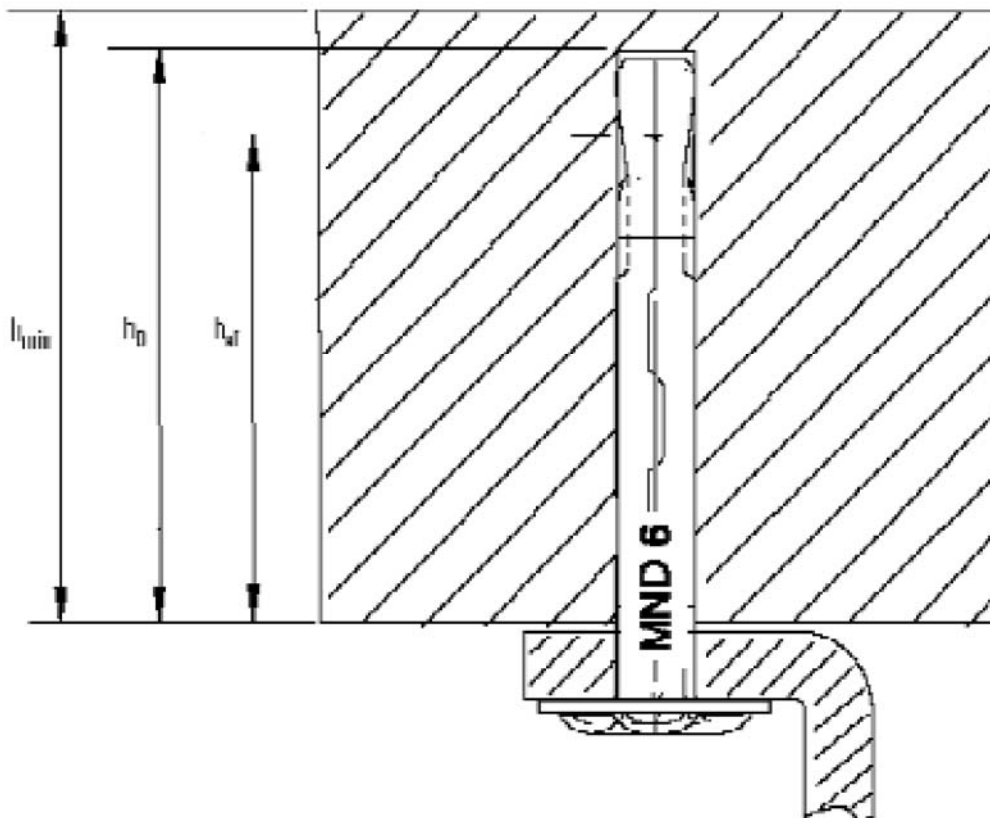
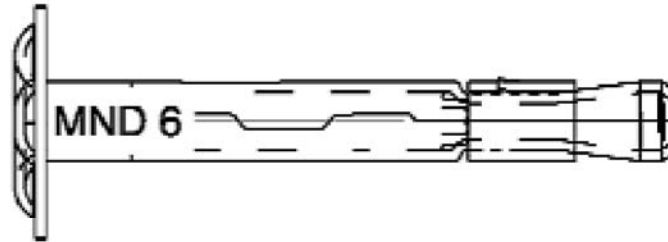

SMK Nail anchor MND 6

Product and intended use

Annex 1

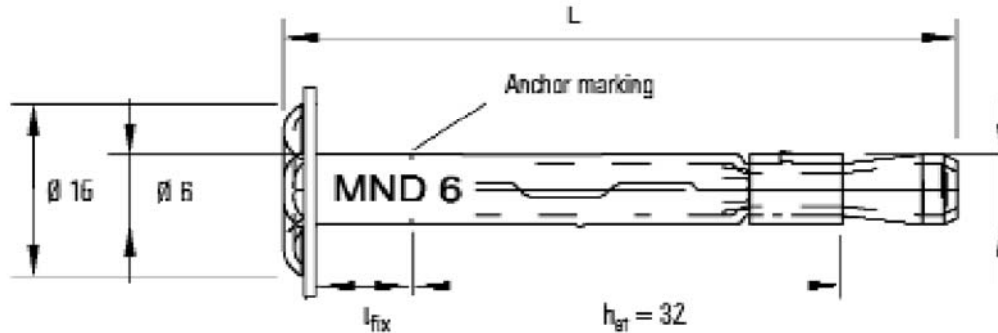

Table 1: Anchor dimension, marking and material

Nail anchor MND 6			MND 6 x 45	MND 6 x 50	MND 6 x 70
Marking / embossing			MND 6/5	MND 6/10	MND 6/35
Anchor length	L	[mm]	45	50	75
Material					
Material steel galvanised			H340LAD Z100 / H420LAD Z100		
Material stainless steel			1.4404 / 1.4571 / 1.4529		

Table 2: Installation parameters

Nail anchor MND 6			MND 6 x 45	MND 6 x 50	MND 6 x 70
Nominal drill hole diameter	d_o	[mm]	6	6	6
Drill hole depth	$h_o \geq$	[mm]	$48 - t_{fix}$	$53 - t_{fix}$	$75 - t_{fix}$
Effective anchorage depth	$h_{ef} \geq$	[mm]	32	32	32
Minimum thickness of concrete member	h_{min}	[mm]	for $t_{fix} > 20\text{mm}$	–	80
			for $t_{fix} \leq 20\text{mm}$	80	80
Maximum thickness of fixture	$\max t_{fix}$	[mm]	5	10	35
Diameter of clearance hole in the fixture	$d_f \leq$	[mm]	7.5		
Minimum spacing	s_{min}	[mm]	200		
Minimum edge distance	c_{min}	[mm]	100		

SMK Nail anchor MND 6

Anchor dimension, installation parameters

Annex 2

Table 3: Design method C: Characteristic values

Nail anchor MND 6			MND 6 x 45, MND 6 x 50, MND 6 x 70	
All load directions			steel galvanised	stainless steel
Characteristic resistance in concrete C20/25 to C50/60	F_{Rk}	[kN]	3.0	4.0
Partial safety factor (incl. installation safety factor $\gamma_2 = 1,0$)	$\gamma_M^{1)}$	[-]	1.5	2.25
Spacing	s_{cr}	[mm]	200	
Edge distance	c_{cr}	[mm]	100	

¹⁾ In absence of other national regulations

**Only for multiple use for non-structural applications,
the definition of multiple use according to the member states
is given in the informative Annex 1 of ETAG 001, Part 6**

Table 4: Characteristic resistance under fire exposure in concrete C20/25 to C50/60 for all load directions without lever arm

Fire resistance class	Nail anchor MND 6			steel galvanised	stainless steel
R 30	Characteristic resistance	$F_{Rk,fi}^{2)}$	[kN]	0.3	1.0
R 60				0.2	1.0
R 90				0.1	0.6
R 120				0.05	0.3
R 30 – R 120	spacing	$s_{cr,fi}$	[mm]	200	
	edge distance ¹⁾	$c_{cr,fi}$	[mm]	100	

¹⁾ The edge distance shall be ≥ 300 mm if there is a fire at more than one side

²⁾ Provided that no other national regulations apply, partial safety factor $\gamma_{m,fi} = 1.0$ is recommended as fire protection

SMK Nail anchor MND 6

Design method C
Characteristic values

Annex 3

Installation instruction

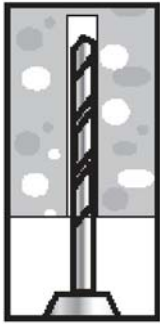

drilling
of hole

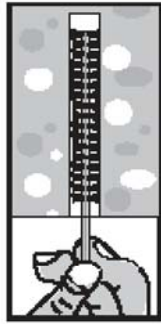

cleaning
of drill hole

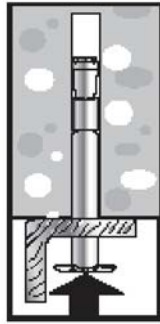

setting anchor
through fixture

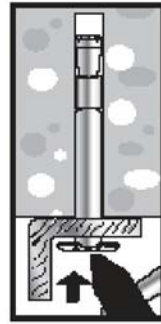

driving in with
a hammer

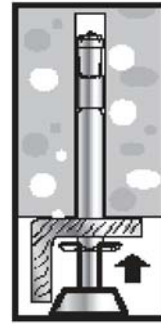

or driving in with
a setting tool

SMK Nail anchor MND 6

Installation instruction

Annex 4