



## European Technical Approval ETA-09/0407

English translation prepared by DIBt - Original version in German language

Handelsbezeichnung  
*Trade name*

G&B Fissaggi Injektionssystem GEBOFIX PRO VE-SF  
für Bewehrungsanschlüsse  
*G&B Fissaggi Injection system GEBOFIX PRO VE-SF  
for rebar connection*

Zulassungsinhaber  
*Holder of approval*

G&B FISSAGGI  
Corso Savona, 22  
10029 Villatellone (TO)  
ITALIEN

Zulassungsgegenstand  
und Verwendungszweck  
*Generic type and use  
of construction product*

Nachträglich eingemörtelter Bewehrungsanschluss mit dem  
G&B Fissaggi Injektionssystem GEBOFIX PRO VE-SF  
*Post-installed rebar connection with  
G&B Fissaggi Injection System GEBOFIX PRO VE-SF*

Geltungsdauer:  
*Validity:* vom  
*from*  
bis  
*to*

16 May 2013  
16 May 2018

Herstellwerk  
*Manufacturing plant*

G&B Fissaggi S.R.L., Plant4

Diese Zulassung umfasst  
*This Approval contains*

21 Seiten einschließlich 12 Anhänge  
*21 pages including 12 annexes*

Diese Zulassung ersetzt  
*This Approval replaces*

ETA-09/0407 mit Geltungsdauer vom 26.02.2010 bis 06.10.2014  
*ETA-09/0407 with validity from 26.02.2010 to 06.10.2014*

## I LEGAL BASES AND GENERAL CONDITIONS

- 1 This European technical approval is issued by Deutsches Institut für Bautechnik in accordance with:
  - Council Directive 89/106/EEC of 21 December 1988 on the approximation of laws, regulations and administrative provisions of Member States relating to construction products<sup>1</sup>, modified by Council Directive 93/68/EEC<sup>2</sup> and Regulation (EC) N° 1882/2003 of the European Parliament and of the Council<sup>3</sup>;
  - *Gesetz über das In-Verkehr-Bringen von und den freien Warenverkehr mit Bauprodukten zur Umsetzung der Richtlinie 89/106/EWG des Rates vom 21. Dezember 1988 zur Angleichung der Rechts- und Verwaltungsvorschriften der Mitgliedstaaten über Bauprodukte und anderer Rechtsakte der Europäischen Gemeinschaften (Bauproduktengesetz - BauPG) vom 28. April 1998<sup>4</sup>, as amended by Article 2 of the law of 8 November 2011<sup>5</sup>;*
  - Common Procedural Rules for Requesting, Preparing and the Granting of European technical approvals set out in the Annex to Commission Decision 94/23/EC<sup>6</sup>;
  - Guideline for European technical approval of "Metal anchors for use in concrete - Part 5: Bonded anchors", ETAG 001-05.
- 2 Deutsches Institut für Bautechnik is authorized to check whether the provisions of this European technical approval are met. Checking may take place in the manufacturing plant. Nevertheless, the responsibility for the conformity of the products to the European technical approval and for their fitness for the intended use remains with the holder of the European technical approval.
- 3 This European technical approval is not to be transferred to manufacturers or agents of manufacturers other than those indicated on page 1, or manufacturing plants other than those indicated on page 1 of this European technical approval.
- 4 This European technical approval may be withdrawn by Deutsches Institut für Bautechnik, in particular pursuant to information by the Commission according to Article 5(1) of Council Directive 89/106/EEC.
- 5 Reproduction of this European technical approval including transmission by electronic means shall be in full. However, partial reproduction can be made with the written consent of Deutsches Institut für Bautechnik. In this case partial reproduction has to be designated as such. Texts and drawings of advertising brochures shall not contradict or misuse the European technical approval.
- 6 The European technical approval is issued by the approval body in its official language. This version corresponds fully to the version circulated within EOTA. Translations into other languages have to be designated as such.

<sup>1</sup> Official Journal of the European Communities L 40, 11 February 1989, p. 12  
<sup>2</sup> Official Journal of the European Communities L 220, 30 August 1993, p. 1  
<sup>3</sup> Official Journal of the European Union L 284, 31 October 2003, p. 25  
<sup>4</sup> *Bundesgesetzblatt Teil I 1998*, p. 812  
<sup>5</sup> *Bundesgesetzblatt Teil I 2011*, p. 2178  
<sup>6</sup> Official Journal of the European Communities L 17, 20 January 1994, p. 34

## II SPECIFIC CONDITIONS OF THE EUROPEAN TECHNICAL APPROVAL

### 1 Definition of product and intended use

#### 1.1 Definition of the construction product

The subject of this approval is the post-installed connection, by anchoring or overlap connection joint, of reinforcing bars (rebars) in existing structures made of normal weight concrete, using the "G&B Fissaggi Injection system GEBOFIX PRO VE-SF for rebar connection" in accordance with the regulations for reinforced concrete construction.

Reinforcing bars made of steel with a diameter  $d_s$  from 8 to 25 mm according to Annex 3 and G&B Fissaggi injection mortar GEBOFIX PRO VE-SF are used for rebar connections. The rebar is placed into a drilled hole filled with injection mortar and is anchored via the bond between rebar, injection mortar and concrete.

#### 1.2 Intended use

The rebar connection may be used in normal weight concrete of a minimum grade of C12/15 and maximum grade C50/60 according to EN 206-1:2000. It may be used in non-carbonated concrete with the allowable chloride content in concrete of 0.40% (CL 0.40) related to the cement content according to EN 206-1.

Rebar connections with reinforcing bars may be used for predominantly static loads.

The fire resistance of post-installed rebar connections is not covered by this European technical approval. Fatigue, dynamic or seismic loading of post-installed rebar connections are not covered by this European technical approval.

Rebar connections may only be carried out in a manner, which is also possible with cast-in straight reinforcing bars, e.g. those in the following applications (see Annexes 2):

- an overlap joint with existing reinforcement in a building component (Figures 1 and 2),
- anchoring of the reinforcement at a slab or beam support, (e.g. according to Figure 3: end support of a slab, designed simply supported, as well as an appropriate general reinforcement for restraint forces),
- anchoring of reinforcement of building components stressed primarily in compression (Figure 4),
- anchoring of reinforcement to cover the envelope line of tensile force in the bending member (Figure 5).

The post-installed rebar connections may be used in the temperature range of  $-40\text{ °C}$  to  $+80\text{ °C}$  (max short term temperature  $+80\text{ °C}$  and max long term temperature  $+50\text{ °C}$ ).

This European technical approval covers anchoring in bore holes made with hammer drilling or compressed air drilling. The post-installed rebar connection may be installed in dry or wet concrete. It must not be installed in flooded holes.

The provisions made in this European technical approval are based on an assumed working life of the post-installed rebar connection of 50 years. The indications given on the working life cannot be interpreted as a guarantee given by the producer, but are to be regarded only as a means for choosing the right products in relation to the expected economically reasonable working life of the works.

## 2 Characteristics of the product and methods of verification

### 2.1 Characteristics of the product

The post-installed rebar connection corresponds to the drawings and provisions given in Annexes 1 to 3. The characteristic material values, dimensions and tolerances not indicated in Annexes 1 to 3 shall correspond to the respective values laid down in the technical documentation<sup>7</sup> of this European technical approval.

The two components of the injection adhesive are delivered in unmixed condition in coaxial cartridges of sizes 150 ml, 280 ml, 300 ml, 310 ml, 330 ml, 380 ml, 410 ml or 420 ml or in side-by-side cartridges of sizes 235 ml, 345 ml or 865 ml according to Annex 1. Each cartridge is marked with the identifying mark "GEBOFIX PRO VE-SF" with the processing notes, charge code, shelf life, hazard code, curing time and processing time (depending on temperature).

The rebar shall comply with the specifications given in Annex 3.

### 2.2 Methods of verification

The assessment of fitness of the post-installed rebar connection for the intended use in relation to the requirements for mechanical resistance and stability and safety in use in the sense of the Essential Requirements 1 and 4 has been made in accordance with the "Guideline for European technical approval of Metal Anchors for Use in Concrete", Part 1 "Anchors in general" and Part 5 "Bonded anchors" and EOTA Technical Report TR 023 "Assessment of post-installed rebar connections"<sup>8</sup>.

In addition to the specific clauses relating to dangerous substances contained in this European technical approval, there may be other requirements applicable to the products falling within its scope (e.g. transposed European legislation and national laws, regulations and administrative provisions). In order to meet the provisions of the Construction Products Directive, these requirements need also to be complied with, when and where they apply.

## 3 Evaluation and attestation of conformity and CE marking

### 3.1 System of attestation of conformity

According to the Decision 96/582/EC of the European Commission<sup>9</sup> system 2(i) (referred to as System 1) of the attestation of conformity applies.

This system of attestation of conformity is defined as follows:

System 1: Certification of the conformity of the product by an approved certification body on the basis of:

- (a) Tasks for the manufacturer:
  - (1) factory production control;
  - (2) further testing of samples taken at the factory by the manufacturer in accordance with a prescribed control plan;

<sup>7</sup> The technical documentation of this European technical approval is deposited at the Deutsches Institut für Bautechnik and, as far as relevant for the tasks of the approved bodies involved in the attestation of conformity procedure, is handed over to the approved bodies.

<sup>8</sup> The Technical Report TR 023 "Assessment of post-installed rebar connections" is published on EOTA website [www.EOTA.eu](http://www.EOTA.eu).

<sup>9</sup> Official Journal of the European Communities L 254 of 08.10.1996

- (b) Tasks for the approved body:
- (3) initial type-testing of the product;
  - (4) initial inspection of factory and of factory production control;
  - (5) continuous surveillance, assessment and approval of factory production control.

Note: Approved bodies are also referred to as "notified bodies".

## 3.2 Responsibilities

### 3.2.1 Tasks for the manufacturer

#### 3.2.1.1 Factory production control

The manufacturer shall exercise permanent internal control of production. All the elements, requirements and provisions adopted by the manufacturer shall be documented in a systematic manner in the form of written policies and procedures, including records of results performed. This production control system shall insure that the product is in conformity with this European technical approval.

The manufacturer may only use initial/raw/constituent materials stated in the technical documentation of this European technical approval.

The factory production control shall be in accordance with the control plan which is part of the technical documentation of this European technical approval. The control plan is laid down in the context of the factory production control system operated by the manufacturer and deposited with Deutsches Institut für Bautechnik.<sup>10</sup>

The results of factory production control shall be recorded and evaluated in accordance with the provisions of the control plan.

#### 3.2.1.2 Other tasks for the manufacturer

The manufacturer shall, on the basis of a contract, involve a body which is approved for the tasks referred to in section 3.1 in the field of anchors in order to undertake the actions laid down in section 3.2.2. For this purpose, the control plan referred to in sections 3.2.1.1 and 3.2.2 shall be handed over by the manufacturer to the approved body involved.

The manufacturer shall make a declaration of conformity, stating that the construction product is in conformity with the provisions of this European technical approval.

### 3.2.2 Tasks for the approved bodies

The approved body shall perform the

- initial type-testing of the product,
- initial inspection of factory and of factory production control,
- continuous surveillance, assessment and approval of factory production control,

in accordance with the provisions laid down in the control plan.

The approved body shall retain the essential points of its actions referred to above and state the results obtained and conclusions drawn in a written report.

The approved certification body involved by the manufacturer shall issue an EC certificate of conformity of the product stating the conformity with the provisions of this European technical approval.

In cases where the provisions of the European technical approval and its control plan are no longer fulfilled the certification body shall withdraw the certificate of conformity and inform Deutsches Institut für Bautechnik without delay.

<sup>10</sup> The control plan is a confidential part of the European technical approval and only handed over to the approved body involved in the procedure of attestation of conformity. See section 3.2.2.

### 3.3 CE marking

The CE marking shall be affixed on each packaging of the injection mortar. The letters "CE" shall be followed by the identification number of the approved certification body, where relevant, and be accompanied by the following additional information:

- the name and address of the holder of the approval (legal entity responsible for the manufacture),
- the last two digits of the year in which the CE marking was affixed,
- the number of the EC certificate of conformity for the product,
- the number of the European technical approval,
- the number of the guideline for European technical approval.

## 4 Assumptions under which the fitness of the product for the intended use was favourably assessed

### 4.1 Manufacturing

The European technical approval is issued for the product on the basis of agreed data/information, deposited with Deutsches Institut für Bautechnik, which identifies the product that has been assessed and judged. Changes to the product or production process, which could result in this deposited data/information being incorrect, should be notified to Deutsches Institut für Bautechnik before the changes are introduced. Deutsches Institut für Bautechnik will decide whether or not such changes affect the approval and consequently the validity of the CE marking on the basis of the approval and if so whether further assessment or alterations to the approval shall be necessary.

### 4.2 Drafting

Rebar connections must be designed in keeping with good engineering practice. Considering the loads to be anchored, design calculations and design drawings must be produced which can be checked. At least the following items must be stated in the design drawings:

- grade of concrete strength,
- diameter, drilling technique, concrete cover, spacing and embedment depth of the rebar,
- length  $l_v$  and length for markings  $l_m$  on the injection extension according to Annex 8,
- use of a guide device (drilling aid) for drilling holes close to edges (if necessary),
- kind of preparation of the joint between building component being connected including the diameter and thickness of concrete layer that has to be removed.

### 4.3 Design

#### 4.3.1 General

The actual position of the reinforcement in the existing structure shall be determined on the basis of the construction documentation and taken into account when designing.

The design of post-installed rebar connections according to Annex 2 and determination of the internal section forces to be transferred in the construction joint shall be verified in accordance with EN 1992-1-1:2004. When ascertaining the tensile force in the rebar, allowance shall be made for the statically effective height of the bonded-in reinforcement.

The verification of the immediate local force transfer to the concrete has been provided.

The verification of the transfer of the loads to be anchored to the building component shall be provided.

The spacing between post-installed rebars shall be greater than the minimum of  $5 d_s$  and 50 mm (see Annex 4).

#### 4.3.2 Determination of the basic anchorage length

The required basic anchorage length  $l_{b,rqd}$  shall be determined in accordance with EN 1992-1-1, Section 8.4.3:

$$l_{b,rqd} = (d_s / 4) (\sigma_{sd} / f_{bd})$$

with:  $d_s$  = diameter of the rebar

$\sigma_{sd}$  = calculated design stress of the rebar

$f_{bd}$  = design value of bond strength according to Annex 5, Table 4  
in consideration of the coefficient related to the quality of bond conditions and of the coefficient related to the bar diameter and of the drilling technique

#### 4.3.3 Determination of the design anchorage length

The required design anchorage length  $l_{bd}$  shall be determined in accordance with EN 1992-1-1, Section 8.4.4:

$$l_{bd} = \alpha_1 \cdot \alpha_2 \cdot \alpha_3 \cdot \alpha_4 \cdot \alpha_5 \cdot l_{b,rqd} \geq l_{b,min}$$

with:  $l_{b,rqd}$  = according to section 4.3.2

$\alpha_1$  = 1.0 for straight bars

$\alpha_2$  = 0.7...1.0 calculated acc. to EN 1992-1-1, Table 8.2

$\alpha_3$  = 1.0 because of no transverse reinforcement

$\alpha_4$  = 1.0 because of no welded transverse reinforcement

$\alpha_5$  = 0.7...1.0 for influence of transverse pressure acc. to EN 1992-1-1, Table 8.2

$l_{b,min}$  = minimum anchorage length acc. to EN 1992-1-1

= max {0.3  $l_{b,rqd}$ ; 10 $d_s$ ; 100 mm} under tension

= max {0.6  $l_{b,rqd}$ ; 10 $d_s$ ; 100 mm} under compression

The maximum permissible embedment depth is given in Annex 5 depending on diameter of the rebar.

#### 4.3.4 Overlap joints

The required design lap length  $l_0$  shall be determined in accordance with EN 1992-1-1, Section 8.7.3:

$$l_0 = \alpha_1 \cdot \alpha_2 \cdot \alpha_3 \cdot \alpha_5 \cdot \alpha_6 \cdot l_{b,rqd} \geq l_{0,min}$$

with:  $l_{b,rqd}$  = according to Section 4.3.2

$\alpha_1$  = 1.0 for straight bars

$\alpha_2$  = 0.7...1.0 calculated acc. to EN 1992-1-1, Table 8.2

$\alpha_3$  = 1.0 because of no transverse reinforcement

$\alpha_5$  = 0.7...1.0 for influence of transverse pressure acc. to EN 1992-1-1, Table 8.2

$\alpha_6$  = 1.0...1.5 for influence of percentage of lapped bars relative to the total cross-section area acc. to EN 1992-1-1, Table 8.3

$l_{0,min}$  = minimum lap length acc. to EN 1992-1-1

= max {0.3  $\alpha_6 l_{b,rqd}$ ; 15 $d_s$ ; 200 mm}

The maximum permissible embedment depth is given in Annex 5 depending on diameter of the rebar.

#### 4.3.5 Embedment depth for overlap joints

For calculation of the effective embedment depth of overlap joints the concrete cover at end-face of bonded-in rebar  $c_1$  shall be considered (see Annex 4, Figure 7):

$$l_v \geq l_0 + c_1$$

with:  $l_0$  = required lap length acc. to Section 4.3.4 and to EN 1992-1-1

$c_1$  = concrete cover at end-face of bonded-in rebar (see Annex 4, Figure 7)

If the clear distance between the overlapping rebars is greater than  $4 d_s$  the lap length shall be enlarged by the difference between the clear distance and  $4 d_s$ .

#### 4.3.6 Concrete cover

The concrete cover required for bonded-in rebars is shown in Annex 5, Table 2, in relation to the drilling method and the hole tolerance.

Furthermore the minimum concrete cover given in EN 1992-1-1, Section 4.4.1.2 shall be observed.

#### 4.3.7 Transverse reinforcement

The requirements of transverse reinforcement in the area of the post-installed rebar connection shall comply with EN 1992-1-1, Section 8.7.4.

#### 4.3.8 Connection joint

The transfer of shear forces between new concrete and existing structure shall be designed according to EN 1992-1-1. The joints for concreting must be roughened to at least such an extent that aggregate protrude.

In case of a carbonated surface of the existing concrete structure the carbonated layer shall be removed in the area of the post-installed rebar connection with a diameter of  $d_s + 60$  mm prior to the installation of the new rebar.

The depth of concrete to be removed shall correspond to at least the minimum concrete cover for the respective environmental conditions in accordance with EN 1992-1-1.

The foregoing may be neglected if building components are new and not carbonated and if building components are in dry conditions.

#### 4.4 Installation

The fitness for use of the post-installed rebar connection can only be assumed if the rebar is installed as follows:

- the installation of post-installed rebar shall be done only by suitable trained installer and under supervision on site; the conditions under which an installer may be considered as suitable trained and the conditions for supervision on site are up to the Member States in which the installation is done,
- use of the injection system only as supplied by the manufacturer without exchanging the components of the Injection system,
- installation in accordance with the manufacturer's specifications and drawings using the tools indicated in the technical documentation of this European technical approval,
- checks before rebar installation to ensure that the strength class of the concrete in which the post-installed rebar connection is to be placed is in the range given and is not lower than that of the concrete to which the characteristic loads apply,
- check of concrete being well compacted, e.g. without significant voids,
- check the position of the existing rebars (if the position of existing rebars is not known, it shall be determined using a rebar detector suitable for this purpose as well as on the basis of the construction documentation and then marked on the building component for the overlap joint),



- keeping the anchorage depth as specified in the design drawings,
- keeping of concrete cover and spacing as specified in the design drawings,
- positioning of the drill holes without damaging the reinforcement,
- in case of aborted drill hole the drill hole shall be filled with mortar,
- the post-installed rebar connection must not be installed in flooded holes,
- the drilling and cleaning of the hole and the installation shall be performed only with the equipment specified by the manufacturer according to the manufacturer's installation instructions (see Annexes 6 to 10), it shall be ensured that this equipment is available on site and it is used,
- during curing of the injection mortar the temperature of the building component must not be less than  $-10\text{ °C}$  and no more than  $+40\text{ °C}$ ; observing the curing time given in Annex 9.

## 5 Recommendations concerning packaging, transport and storage

### 5.1 Responsibility of the manufacturer

It is in the responsibility of the manufacturer to ensure that the information on the specific conditions according to sections 1 and 2 including Annexes referred to as well as sections 4 and 5.2 is given to those who are concerned. This information may be made by reproduction of the respective parts of the European technical approval. In addition all installation data shall be shown clearly on the package and/or on an enclosed instruction sheet, preferably using illustration(s).

The minimum data required are:

- drill bit diameter,
- diameter of rebar,
- admissible service temperature range,
- curing time of the injection mortar,
- Installation instructions including cleaning of the drill hole,
- reference to any special installation equipment needed,
- identification of the manufacturing batch,

All data shall be presented in a clear and explicit form.

### 5.2 Packaging, transport and storage

The mortar cartridges shall be protected against sun radiation and shall be stored according to the manufacture's installation instructions in dry condition at temperatures of at least  $+5\text{ °C}$  to not more than  $+25\text{ °C}$ .

Mortar cartridges with expired shelf life must no longer be used.

Uwe Bender  
Head of Department

*beglaubigt:*  
Baderschneider

## Product description and intended use

Covered are only post-installed rebar connections in non-carbonated concrete (concrete C12/15 – C50/60 according to EN 206-1:2000) on the assumption only that the design of post-installed rebar connections is done in accordance to EN 1992-1-1:2004.

- Installation in dry or wet concrete, it must not be installed in flooded holes.
- Maximum short term temperature +80°C and max. long term temperature +50°C
- Reinforcing bar  $\varnothing$  8 mm to 25 mm with properties of class B and C according to Annex 3
- Maximum embedment depth see Annex 5, Table 3

### G&B Fissaggi Injection system GEBOFIX PRO VE-SF:

Dispensing tools: see Annex 10, Table 8

Brush:

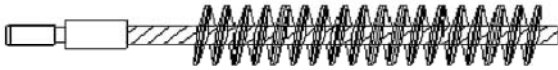

Brush extension:



SDS Plus Adapter:



Hand-pump:



Hand slide valve with air hose:



Injection mortar: GEBOFIX PRO VE-SF

Typ "coaxial": 150 ml, 280 ml,  
300 ml, 310ml, 330 ml, 380 ml, 410 ml  
und 420 ml Kartusche



Imprint: GEBOFIX PRO VE-SF,  
processing notes, charge-code, shelf life,  
hazard-code, curing- and processing time  
(depending on the temperature), with as well as  
without travel scale

Type "side-by-side":  
235 ml, 345 ml and 825 ml  
cartridge

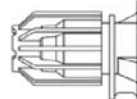

Imprint: GEBOFIX PRO VE-SF,  
processing notes, charge-code, shelf life,  
hazard-code, curing- and processing time  
(depending on the temperature), with as well as  
without travel scale

Static Mixer

CRW 14W

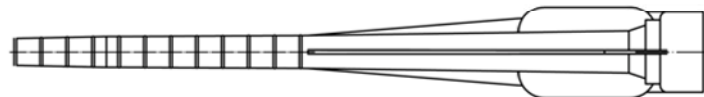

TAH 18W



Piston plug and  
mixer extension

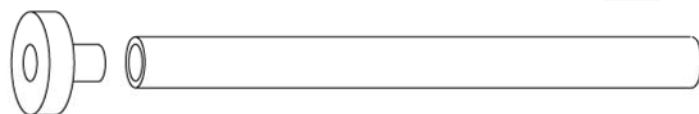

G&B Fissaggi Injection system GEBOFIX PRO VE-SF for rebar connection

Product description and Intended use

**Annex 1**

**Figure 1:** Overlapping joint for rebar connections of slabs and beams

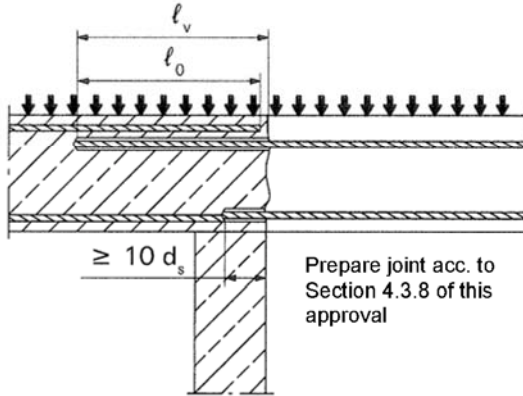

**Figure 2:** Overlapping joint at a foundation of a wall or column where the rebars are stressed in tension

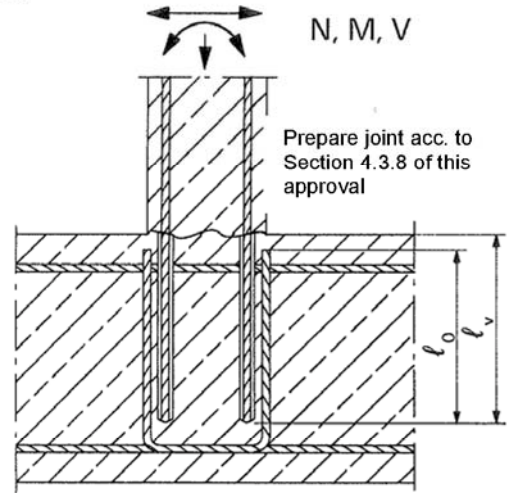

**Figure 3:** End anchoring of slabs or beams, designed as simply supported

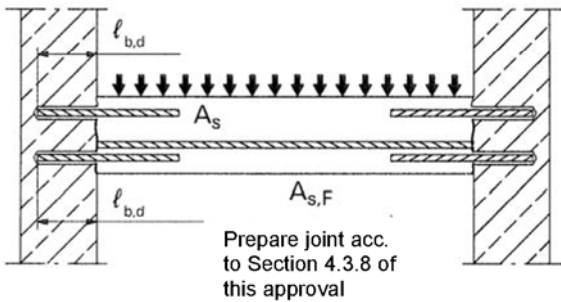

**Figure 4:** Rebar connection for components stressed primarily in compression. The rebars are stressed in compression

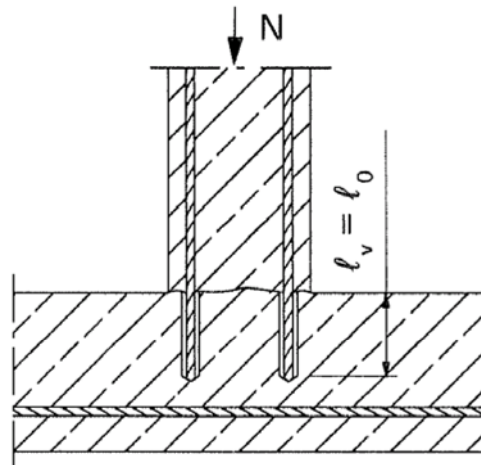

**Figure 5:** Anchoring of reinforcement to cover the line of acting tensile force

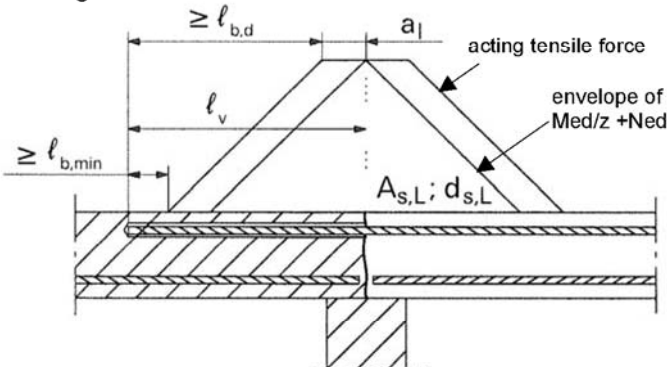

**Note to Figure 1 to 5:**

In the figures no transverse reinforcement is plotted, the transverse reinforcement as required by EN 1992-1-1 shall be present.

The shear transfer between old and new concrete shall be designed according to EN 1992-1-1

General rules for construction and design compare Annex 4.

G&B Fissaggi Injection system GEBOFIX PRO VE-SF for rebar connection

Examples of use for rebars

**Annex 2**

**Figure 6:** Properties of reinforcement

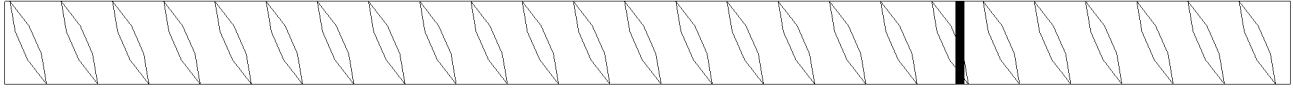

**Table 1a:** Abstract of EN 1992-1-1 Annex C, Table C.1, Properties of reinforcement

Product form		Bars and de-coiled rods	
Class		B	C
Characteristic yield strength $f_{yk}$ or $f_{0,2k}$ (N/mm <sup>2</sup> )		400 to 600	
Minimum value of $k = (f_t / f_y)_k$		$\geq 1,08$	$\geq 1,15$ < 1,35
Characteristic strain at maximum force $\epsilon_{uk}$ (%)		$\geq 5,0$	$\geq 7,5$
Bendability		Bend/Rebend test	
Maximum deviation from nominal mass (individual bar) (%)	Nominal bar size (mm)		
	$\leq 8$	$\pm 6,0$	
	$> 8$	$\pm 4,5$	

**Table 1b:** Abstract of EN 1992-1-1 Annex C, Table C.2N, Properties of reinforcement

Product form		Bars and de-coiled rods	
Class		B	C
Min. value of related rip area (according EN 15630) $f_{R,min}$	nominal diameter of the rebar (mm)		
	8 to 12	0,040	
	$> 12$	0,056	

Rip height of the bar shall be in the range  $0,05d \leq h \leq 0,07d$   
(d: Nominal diameter of the bar; h: Rip height of the bar)

G&B Fissaggi Injection system GEBOFIX PRO VE-SF for rebar connection

Properties of reinforcement

**Annex 3**

**Figure 7:** General design rules of construction for bended-in rebars

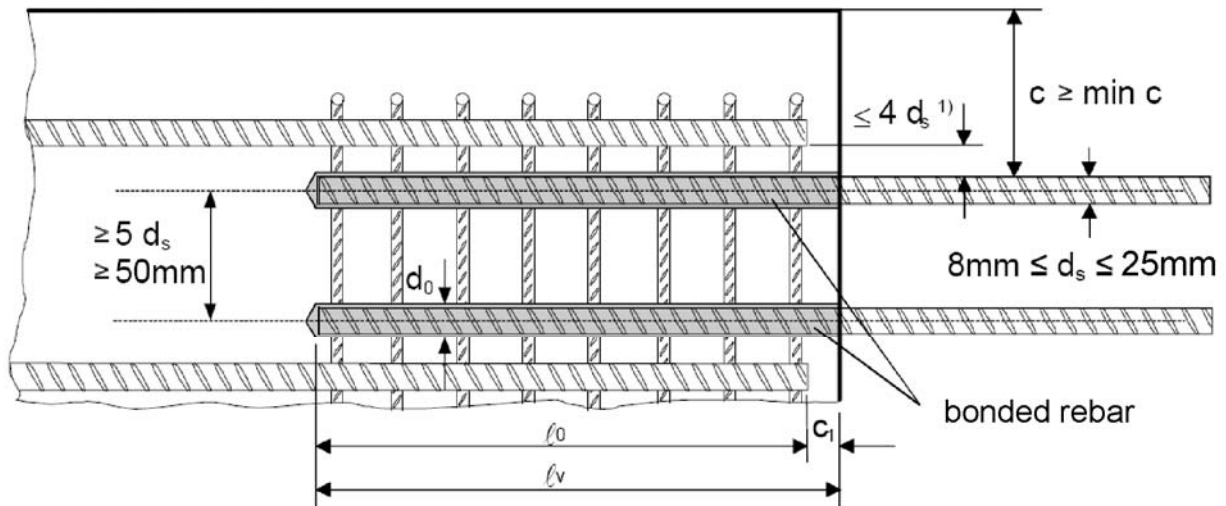

- 1) If the clear distance between lapped bars exceeds  $4d_s$ , then the lap length shall be increased by the difference between the clear bar distance and  $4d_s$ .

The following applies to Figure 7:

- $l_v$  or  $l_0$  are in accordance with section 4.3.4 and 4.3.5 of the approval
- The provision of sufficient transverse reinforcement according to section 4.3.7 of this approval

c	concrete cover post installed rebar
$c_1$	concrete cover at end-face of bond-in bar
min c	minimum concrete cover according to Annex 5
$d_s$	diameter bonded-in bar
$l_0$	lap length
$l_v$	effective embedment depth
$d_0$	normal drill bit diameter, see Annex 7

**Table 2:** Minimum concrete cover min c of bonded-in rebar depending of drilling method

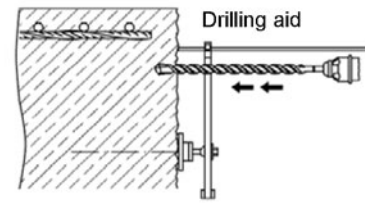

Drilling method	Rebar diameter	Without drilling aid	With drilling aid
Hammer drilling	< 25 mm	$30 \text{ mm} + 0,06 \cdot l_v \geq 2 d_s$	$30 \text{ mm} + 0,02 \cdot l_v \geq 2 d_s$
	= 25 mm	$40 \text{ mm} + 0,06 \cdot l_v \geq 2 d_s$	$40 \text{ mm} + 0,02 \cdot l_v \geq 2 d_s$
Compressed air drilling	< 25 mm	$50 \text{ mm} + 0,08 \cdot l_v$	$50 \text{ mm} + 0,02 \cdot l_v$
	= 25 mm	$60 \text{ mm} + 0,08 \cdot l_v$	$60 \text{ mm} + 0,02 \cdot l_v$

The minimum concrete cover must be observed according EN 1992-1-1:2004

**Table 3:** Minimum anchorage length<sup>1)</sup> and lap splice length for C20/25 and maximum installation length  $l_{max}$

Rebar		$l_{b,min}$ [mm]	$l_{o,min}$ [mm]	$l_{max}$ [mm]
$\varnothing d_s$	$f_{y,k}$ [N/mm <sup>2</sup> ]			
8 mm	500	113	200	1000
10 mm	500	142	200	1000
12 mm	500	170	200	1200
14 mm	500	198	210	1400
16 mm	500	227	240	1600
20 mm	500	284	300	2000
22 mm	500	312	330	2000
24 mm	500	340	360	2000
25 mm	500	354	375	2000

<sup>1)</sup> according to EN 1992-1-1:2004:  $l_{b,min}$  (8.6) and  $l_{o,min}$  (8.11) for good bond conditions and  $a_b = 1,0$  with maximum yield stress for rebar B500 B and  $\gamma_M = 1,15$

**Table 4:** Design values of the ultimate bond resistance  $f_{bd}$ <sup>1)</sup> in N/mm<sup>2</sup> for all drilling methods for good conditions

Rebar - $\varnothing$	Concrete class								
	C12/15	C16/20	C20/25	C25/30	C30/37	C35/45	C40/50	C45/55	C50/60
8 to 25 mm	1,6	2,0	2,3	2,7	3,0	3,4	3,7	4,0	4,3

<sup>1)</sup> Tabulated values for  $f_{bd}$  are valid for good bond condition according to EN 1992-1-1:2004. For all other bond conditions multiply the values for  $f_{bd}$  by 0,7.

G&B Fissaggi Injection system GEBOFIX PRO VE-SF for rebar connection

Installation parameters and design values of ultimate bond resistance  $f_{bd}$

**Annex 5**

## A) Bore hole drilling

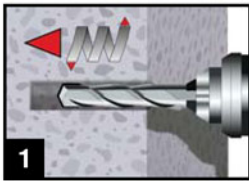

1. Drill a hole into the base material to the size and embedment depth required by the selected reinforcing bar with carbide hammer drill (HD) or a compressed air drill (CD).



Hammer drill (HD)

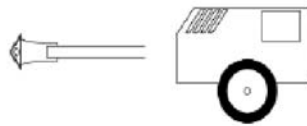

Compressed air drill (CD)

Rebar - $\varnothing$	Drill - $\varnothing$
$d_s$	[mm]
8 mm	12
10 mm	14
12 mm	16
14 mm	18
16 mm	20
20 mm	25
22 mm	28
24 mm	32
25 mm	32

## B) Bore hole cleaning

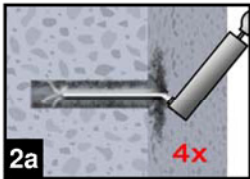

or

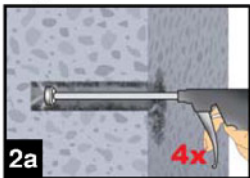

- 2a. Starting from the bottom or back of the bore hole, blow the hole clean with compressed air (min. 6 bar) or a hand pump a minimum of four times. If the bore hole ground is not reached an extension shall be used.

For bore holes deeper than 240 mm, compressed air (min. 6 bar) **must** be used.

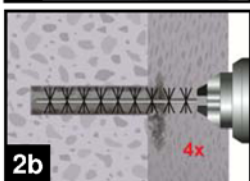

- 2b. Check brush diameter (Table 5) and attach the brush to a drilling machine or a battery screwdriver. Brush the hole with an appropriate sized wire brush  $> d_{b,min}$  (Table 5) a minimum of four times. If the bore hole ground is not reached with the brush, a brush extension shall be used.

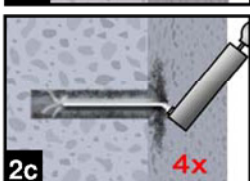

or



- 2c. Finally blow the hole clean again with compressed air (min. 6 bar) or a hand pump a minimum of four times. If the bore hole ground is not reached an extension shall be used.

For bore holes deeper than 240 mm, compressed air (min. 6 bar) **must** be used.

G&B Fissaggi Injection system GEBOFIX PRO VE-SF for rebar connection

Installation instruction  
Bore hole drilling  
Bore hole cleaning

**Annex 6**

**Table 5:** Cleaning tools

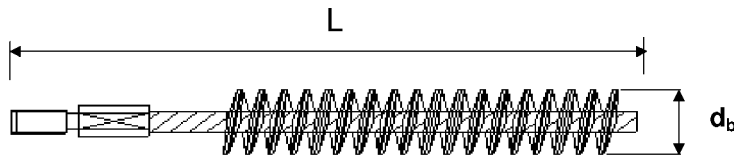

$d_s$ Rebar - $\varnothing$	$d_0$ Drill bit - $\varnothing$	$d_b$ Brush - $\varnothing$	$d_{b,min}$ min. Brush - $\varnothing$	L Total length
(mm)	(mm)	(mm)	(mm)	(mm)
8	12	14	12,5	170
10	14	16	14,5	200
12	16	18	16,5	200
14	18	20	18,5	300
16	20	22	20,5	300
20	25	27	25,5	300
22	28	30	28,5	300
24	32	34	32,5	300
25	32	34	32,5	300



Hand pump (volume 750 ml)

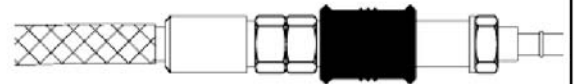

Rec. compressed air tool  
hand slide valve (min 6 bar)

**C) Preparation of bar and cartridge**

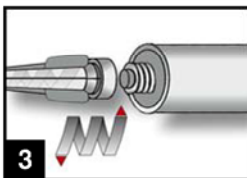

3. Attach the supplied static-mixing nozzle to the cartridge and load the cartridge into the correct dispensing tool.  
For every working interruption longer than the recommended working time (Table 7) as well as for every new cartridges, a new static-mixer shall be used.

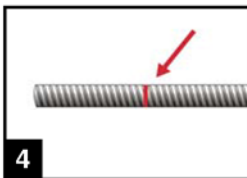

4. Prior to inserting the reinforcing bar into the filled bore hole, the position of the embedment depth shall be marked (e.g. with tape) on the reinforcing bar and insert bar in empty hole to verify hole and depth  $l_v$ .  
The anchor should be free of dirt, grease, oil or other foreign material.

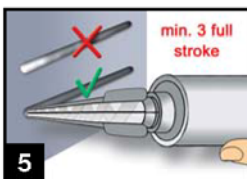

5. Prior to dispensing into the anchor hole, squeeze out separately the mortar until it shows a consistent grey colour, but a minimum of three full strokes, and discard non-uniformly mixed adhesive components.

G&B Fissaggi Injection system GEBOFIX PRO VE-SF for rebar connection

Installation instruction  
Cleaning tools  
Preparation of bar and cartridge

**Annex 7**



## D) Filling the bore hole

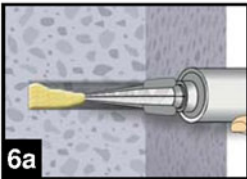

6. Starting from the bottom or back of the cleaned anchor hole fill the hole up to approximately two-thirds with adhesive. Slowly withdraw the static mixing nozzle as the hole fills to avoid creating air pockets. For embedment larger than 190 mm an extension nozzle shall be used.

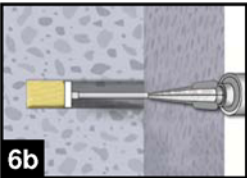

For overhead and horizontal installation and bore holes deeper than 240 mm a piston plug and the appropriate mixer extension must be used.

Observe the gel-/ working times given in Table 7.

**Table 6:** Piston plugs, max anchorage depth and mixer extension

Bar size	Drill bit - Ø		Piston plug	Cartridge: All sizes				Cartridge: side-by-side (825 ml)	
	HD	PD		Hand or battery tool		Pneumatic tool		Pneumatic tool	
				$l_{max}$	Mixer extension	$l_{max}$	Mixer extension	$l_{max}$	Mixer extension
(mm)	(mm)		No.	(cm)		(cm)		(cm)	
8	12	-	-	70	VL 10/0,75	80	VL 10/0,75	80	VL 10/0,75
10	14	-	#14			100		100	
12	16		#16			140		140	
14	18		#18			160		160	
16	20		#20			200		200	
20	25	26	#25	50	VL 16/1,8	70	VL 16/1,8	70	VL 16/1,8
22	28		#28			50		50	
24	32		#32						
25	32		#32						

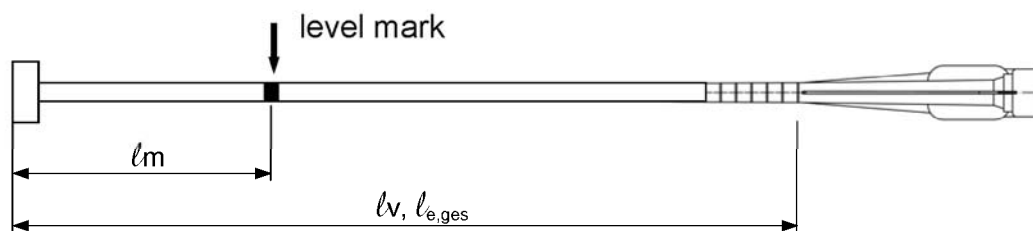

Injection tool must be marked by mortar level mark  $l_m$  and anchorage depth  $l_v$  resp.  $l_{e,ges}$  with tape or marker.

Quick estimation:  $l_m = 1/3 \cdot l_v$

Continue injection until the mortar level mark  $l_m$  becomes visible.

Optimum mortar volume:  $l_m = l_v$  resp.  $l_{e,ges} \cdot \left( 1,2 \cdot \frac{d_s^2}{d_0^2} - 0,2 \right)$  [mm]

G&B Fissaggi Injection system GEBOFIX PRO VE-SF for rebar connection

Installation instruction

Filling the bore hole

**Annex 8**

## E) Inserting the rebar

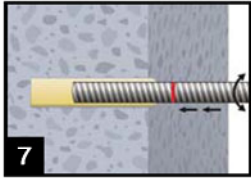

7. Push the reinforcing bar into the anchor hole while turning slightly to ensure positive distribution of the adhesive until the embedment depth is reached.

The bar should be free of dirt, grease, oil or other foreign material.

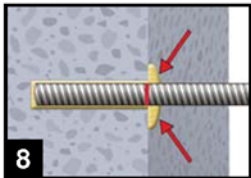

8. Be sure that the bar is inserted in the bore hole until the embedment mark is at the concrete surface and that excess mortar is visible at the top of the hole. If these requirements are not maintained, the application has to be renewed. For overhead installation fix embedded part (e.g. wedges).

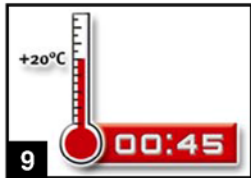

9. Observe gelling time  $t_{gel}$ . Attend that the gelling time can vary according to the base material temperature (see Table 7). It is not allowed to move the bar after gelling time  $t_{gel}$  has elapsed.

Allow the adhesive to cure to the specified time prior to applying any load. Do not move or load the bar until it is fully cured (attend Table 7). After full curing time  $t_{cure}$  has elapsed, the add-on part can be installed.

**Table 7:** Base material temperature, gelling time and curing time

Concrete temperature	Gelling- / working time <sup>1)</sup>	Minimum curing time in dry concrete <sup>5)</sup>
	$t_{gel}$	$t_{cure,dry}$
-10°C bis -6°C	90 min <sup>2)</sup>	24 h
-5°C bis -1°C	90 min <sup>3)</sup>	14 h
0°C bis +4°C	45 min <sup>3)</sup>	7 h
+5°C bis +9°C	25 min <sup>3)</sup>	2 h
+10°C bis +19°C	15 min <sup>3)</sup>	80 min
+20°C bis +24°C	6 min <sup>3)</sup>	45 min
+25°C bis +29°C	4 min <sup>3)</sup>	25 min
+30°C bis +40°C	2,5 min <sup>4)</sup>	15 min

<sup>1)</sup>  $t_{gel}$ : maximum time from starting of mortar injection to completing of rebar setting.

<sup>2)</sup> Cartridge temperature **must** be at minimum +15°C

<sup>3)</sup> Cartridge temperature **must** be between +5°C and +25°C

<sup>4)</sup> Cartridge temperature **must** be below +20°C









<sup>5)</sup> In wet concrete the curing time  $t_{cure,dry}$  has to be doubled up

G&B Fissaggi Injection system GEBOFIX PRO VE-SF for rebar connection

Installation instruction  
Inserting rebar  
Gelling time and curing time

**Annex 9**

**Table 8:** Dispensing tools

Cartridge type/size	Hand tool		Pneumatic tool
Coaxial cartridges 150, 280, 300, 310, 330 ml	 e.g. Type H 297 or H244C		 e.g. Type TS 492 X
Coaxial cartridges 380, 410, 420 ml	 e.g. Type CCM 380/10	 e.g. Type H 285 or H244C	 e.g. Type TS 485 LX
Side-by-side cartridges 235, 345 ml	 e.g. Type CBM 330A	 e.g. Type H 260	 e.g. Type TS 477 LX
Side-by-side cartridge 825 ml	-	-	 e.g. Type TS 498X

All cartridges could also be extruded by a battery tool.

G&B Fissaggi Injection system GEBOFIX PRO VE-SF for rebar connection

Dispensing tools

**Annex 10**

**Table 9:** Values for pre-calculation of anchoring.  
Example for: C20/25; good bond condition; Rebar yield strength 500 N/mm<sup>2</sup>

Bar-Ø d <sub>s</sub>	α <sub>1</sub> =α <sub>2</sub> =α <sub>3</sub> =α <sub>4</sub> =α <sub>5</sub> =1,0			α <sub>2</sub> or α <sub>5</sub> =0,7; α <sub>1</sub> =α <sub>3</sub> =α <sub>4</sub> =1,0		
	Anchorage length l <sub>bd</sub>	Design value N <sub>Rd</sub>	Mortar volume	Anchorage length l <sub>bd</sub>	Design value N <sub>Rd</sub>	Mortar volume
[mm]	[mm]	[kN]	[ml]	[mm]	[kN]	[ml]
8	113*	6,53	9	113*	9,33	9
	180	10,40	14	150	12,39	11
	250	14,45	19	190	15,69	14
	378	21,85	29	265	21,88	20
10	142*	10,26	13	142*	14,66	13
	220	15,90	20	190	19,61	17
	310	22,40	28	240	24,77	22
	390	28,18	35	280	28,90	25
12	473	34,18	43	331	34,17	30
	170*	14,74	18	170*	21,06	18
	270	23,41	29	230	28,49	24
	370	32,08	39	280	34,68	30
14	470	40,75	50	340	42,12	36
	567	49,16	60	397	49,18	42
	198*	20,03	24	198*	28,61	24
	310	31,36	37	260	37,57	31
16	430	43,50	52	330	47,69	40
	550	55,64	66	400	57,81	48
	662	66,97	80	463	66,91	56
	227*	26,24	31	227*	37,49	31
20	360	41,62	49	300	49,55	41
	490	56,65	67	380	62,76	52
	620	71,68	84	450	74,32	61
	756	87,40	103	529	87,37	72
22	284*	41,04	60	284*	58,63	60
	450	65,03	95	380	78,45	81
	610	88,15	129	470	97,03	100
	780	112,72	165	570	117,68	121
24	945	136,57	200	662	136,67	140
	312*	49,60	88	312*	70,85	88
	490	77,89	139	420	95,38	119
	680	108,10	192	520	118,09	147
25	860	136,71	243	620	140,80	175
	1040	165,32	294	728	165,32	206
	340*	58,96	144	340*	84,23	144
	540	93,64	228	450	111,48	190
25	740	128,33	312	570	141,21	241
	940	163,01	397	680	168,46	287
	1134	196,65	479	794	196,70	335
	354*	63,95	133	354*	91,35	133
25	560	101,16	211	470	121,29	177
	770	139,09	290	590	152,26	222
	970	175,22	365	710	183,22	267
	1181	213,34	444	827	213,42	311

\* minimum anchorage length, see also Annex 5 Table 3; The design value is valid for "good bond conditions" according to EN 1992-1-1. All other condition: multiply value by 0,7. Mortar volume based on equation:

$$V = 1,2 \cdot (d_0^2 - d_s^2) \cdot \pi \cdot l_b / 4$$

G&B Fissaggi Injection system GEBOFIX PRO VE-SF for rebar connection

Values for pre-calculation of anchoring.  
Example for:  
C20/25; good bond condition; Rebar yield strength 500 N/mm<sup>2</sup>

**Annex 11**

**Table 10:** Values for pre-calculation of overlap joints.  
Example for: C20/25; good bond condition; Rebar yield strength 500 N/mm<sup>2</sup>

Bar- $\varnothing$ $d_s$	$\alpha_1=\alpha_2=\alpha_3=\alpha_4=\alpha_5=1,0$			$\alpha_2$ or $\alpha_5=0,7$ ; $\alpha_1=\alpha_3=\alpha_4=1,0$		
	Lap length $l_0$	Design value $N_{Rd}$	Mortar volume	Lap length $l_0$	Design value $N_{Rd}$	Mortar volume
[mm]	[mm]	[kN]	[ml]	[mm]	[kN]	[ml]
8	200*	11,56	15	200*	16,52	15
	240	13,87	18	220	18,17	17
	290	16,76	22	230	18,99	17
	378	21,85	29	265	21,88	20
10	200*	14,45	18	200*	20,64	18
	270	19,51	24	230	23,74	21
	340	24,57	31	270	27,87	24
	400	28,90	36	300	30,97	27
12	473*	34,18	43	331*	34,17	30
	200*	17,34	21	200*	24,77	21
	290	25,15	31	250	30,97	26
	380	32,95	40	300	37,16	32
14	480	41,62	51	350	43,35	37
	567	49,16	60	397	49,18	42
	210*	21,24	25	210*	30,35	25
	320	32,37	39	270	39,02	33
16	440	44,51	53	340	49,13	41
	550	55,64	66	400	57,81	48
	662	66,97	80	463	66,91	56
	240*	27,75	33	240*	39,64	33
20	370	42,78	50	310	51,20	42
	500	57,81	68	380	62,76	52
	630	72,83	86	460	75,97	62
	756	87,40	103	529	87,37	72
22	300*	43,35	64	300*	61,93	64
	460	66,48	98	390	80,51	83
	620	89,60	131	480	99,09	102
	780	112,72	165	570	117,68	121
24	945	136,57	200	662	136,67	140
	330*	52,46	93	330*	74,94	93
	510	81,07	144	430	97,65	122
	680	108,10	192	530	120,36	150
25	860	136,71	243	630	143,07	178
	1040	165,32	294	728	165,32	206
	360*	62,43	152	360*	89,19	152
	550	95,38	232	470	116,44	198
25	750	130,06	317	580	143,69	245
	940	163,01	397	690	170,94	291
	1134	196,65	479	794	196,70	335
	375*	67,74	141	375*	96,77	141
25	580	104,77	218	490	126,45	184
	780	140,90	293	600	154,84	226
	980	177,03	369	710	183,22	267
	1181	213,34	444	827	213,42	311

\* minimum anchorage length, see also Annex 5 Table 3; The design value is valid for "good bond conditions" according to EN 1992-1-1. All other condition: multiply value by 0,7. Mortar volume based on equation:  $V = 1,2 \cdot (d_0^2 - d_s^2) \cdot \pi \cdot l_b / 4$

G&B Fissaggi Injection system GEBOFIX PRO VE-SF for rebar connection

Values for pre-calculation of overlap joints.  
Example for:  
C20/25; good bond condition; Rebar yield strength 500 N/mm<sup>2</sup>

**Annex 12**