



European Technical Approval ETA-11/0240

English translation prepared by DIBt - Original version in German language

Handelsbezeichnung
Trade name

MKT Nagelanker N
MKT Nail Anchor N

Zulassungsinhaber
Holder of approval

MKT
Metall-Kunststoff-Technik GmbH & Co. KG
Auf dem Immel 2
67685 Weilerbach
DEUTSCHLAND

Zulassungsgegenstand
und Verwendungszweck
*Generic type and use
of construction product*

Lastkontrolliert spreizender Dübel für die Verwendung als
Mehrfachbefestigung von nichttragenden Systemen in Beton
*Load controlled expansion anchor for multiple use for non-structural
applications in concrete*

Geltungsdauer:
Validity: vom
from
bis
to

29 January 2013
29 January 2018

Herstellwerk
Manufacturing plant

MKT
Metall-Kunststoff-Technik GmbH & Co. KG
Auf dem Immel 2
67685 Weilerbach
DEUTSCHLAND

Diese Zulassung umfasst
This Approval contains

13 Seiten einschließlich 5 Anhänge
13 pages including 5 annexes

Diese Zulassung ersetzt
This Approval replaces

ETA-11/0240 mit Geltungsdauer vom 26.07.2011 bis 26.07.2016
ETA-11/0240 with validity from 26.07.2011 to 26.07.2016

I LEGAL BASES AND GENERAL CONDITIONS

- 1 This European technical approval is issued by Deutsches Institut für Bautechnik in accordance with:
 - Council Directive 89/106/EEC of 21 December 1988 on the approximation of laws, regulations and administrative provisions of Member States relating to construction products¹, modified by Council Directive 93/68/EEC² and Regulation (EC) N° 1882/2003 of the European Parliament and of the Council³;
 - *Gesetz über das In-Verkehr-Bringen von und den freien Warenverkehr mit Bauprodukten zur Umsetzung der Richtlinie 89/106/EWG des Rates vom 21. Dezember 1988 zur Angleichung der Rechts- und Verwaltungsvorschriften der Mitgliedstaaten über Bauprodukte und anderer Rechtsakte der Europäischen Gemeinschaften (Bauproduktengesetz - BauPG) vom 28. April 1998⁴, as amended by Article 2 of the law of 8 November 2011⁵;*
 - Common Procedural Rules for Requesting, Preparing and the Granting of European technical approvals set out in the Annex to Commission Decision 94/23/EC⁶;
 - Guideline for European technical approval of "Metal anchors for use in concrete - Part 6: Anchors for multiple use for non-structural applications", ETAG 001-06.
- 2 Deutsches Institut für Bautechnik is authorized to check whether the provisions of this European technical approval are met. Checking may take place in the manufacturing plant. Nevertheless, the responsibility for the conformity of the products to the European technical approval and for their fitness for the intended use remains with the holder of the European technical approval.
- 3 This European technical approval is not to be transferred to manufacturers or agents of manufacturers other than those indicated on page 1, or manufacturing plants other than those indicated on page 1 of this European technical approval.
- 4 This European technical approval may be withdrawn by Deutsches Institut für Bautechnik, in particular pursuant to information by the Commission according to Article 5(1) of Council Directive 89/106/EEC.
- 5 Reproduction of this European technical approval including transmission by electronic means shall be in full. However, partial reproduction can be made with the written consent of Deutsches Institut für Bautechnik. In this case partial reproduction has to be designated as such. Texts and drawings of advertising brochures shall not contradict or misuse the European technical approval.
- 6 The European technical approval is issued by the approval body in its official language. This version corresponds fully to the version circulated within EOTA. Translations into other languages have to be designated as such.

¹ Official Journal of the European Communities L 40, 11 February 1989, p. 12
² Official Journal of the European Communities L 220, 30 August 1993, p. 1
³ Official Journal of the European Union L 284, 31 October 2003, p. 25
⁴ *Bundesgesetzblatt Teil I 1998*, p. 812
⁵ *Bundesgesetzblatt Teil I 2011*, p. 2178
⁶ Official Journal of the European Communities L 17, 20 January 1994, p. 34

II SPECIFIC CONDITIONS OF THE EUROPEAN TECHNICAL APPROVAL

1 Definition of the product and intended use

1.1 Definition of the construction product

The MKT Nail Anchor N is an anchor made of galvanised steel, stainless steel (marking "A4") or high corrosion resistant steel 1.4529/1.4565 (marking "HCR") which is pushed into a drilled hole and expanded by loading. The anchor head is provided with connecting thread M6 or M8, with nail head, a coupling nut or with a loop, respectively.

An illustration of the product is given in Annex 1.

1.2 Intended use

The anchor is intended to be used for anchorages for which requirements for safety in use in the sense of the Essential Requirements 4 of Council Directive 89/106 EEC shall be fulfilled and failure of the fixture represents an immediate risk to human life. The anchor is to be used only for multiple use for non-structural applications. The definition of multiple use according to the Member States is given in the informative Annex 1 of ETAG 001, Part 6.

The anchor may be used for anchorages with requirements related to resistance to fire.

The anchor is to be used only for anchorages subject to static or quasi-static loading in reinforced or unreinforced normal weight concrete of strength classes C12/15 at minimum and C50/60 at most according to EN 206-1:2000-12. It may be anchored in cracked or non-cracked concrete.

MKT Nail Anchor N made of galvanised steel:

The anchor may only be used in structures subject to dry internal conditions.

MKT Nail Anchor N A4 made of stainless steel:

The anchor made of stainless steel may be used in structures subject to dry internal conditions and also in structures subject to external atmospheric exposure (including industrial and marine environment), or exposure in permanently damp internal conditions, if no particular aggressive conditions exist. Such particular aggressive conditions are e.g. permanent, alternating immersion in seawater or the splash zone of seawater, chloride atmosphere of indoor swimming pools or atmosphere with extreme chemical pollution (e.g. in desulphurization plants or road tunnels where de-icing materials are used).

MKT Nail Anchor N HCR made of high corrosion resistant steel 1.4529 or 1.4565:

The anchor made of high corrosion resistant steel may be used in structures subject to dry internal conditions and also in structures subject to external atmospheric exposure, in permanently damp internal conditions or in other particular aggressive conditions. Such particular aggressive conditions are e.g. permanent, alternating immersion in seawater or the splash zone of seawater, chloride atmosphere of indoor swimming pools or atmosphere with chemical pollution (e.g. in desulphurization plants or road tunnels where de-icing materials are used).

The provisions made in this European technical approval are based on an assumed working life of the anchor of 50 years. The indications given on the working life cannot be interpreted as a guarantee given by the producer, but are to be regarded only as a means for choosing the right products in relation to the expected economically reasonable working life of the works.

2 Characteristics of the product and methods of verification

2.1 Characteristics of the product

The anchor corresponds to the drawings and provisions given in Annex 1. The characteristic material values, dimensions and tolerances of the anchor not given in Annex 1 shall correspond to the respective values laid down in the technical documentation⁷ of this European technical approval.

Regarding the requirements concerning safety in case of fire it is assumed that the anchor meets the requirements of class A1 in relation to reaction to fire in accordance with the stipulations of the Commission decision 96/603/EC, amended by 2000/605/EC.

The characteristic values for the design of anchorages are given in the Annexes.

Each anchor is marked according Annex 1. Each MKT Nail Anchor N A4 made of stainless steel is marked with the additional letters "A4". Each MKT Nail Anchor N HCR made of high corrosion resistant steel 1.4529/1.4565 is marked with the additional letters "HCR".

2.2 Methods of verification

The assessment of fitness of the anchor for the intended use in relation to the requirements for safety in use in the sense of the Essential Requirements 4 has been made in accordance with the "Guideline for European technical approval of Metal Anchors for use in concrete", Part 1 "Anchors in general" and Part 6 "Anchors for multiple use for non-structural applications".

The assessment of the anchor for the intended use in relation to the requirements for resistance to fire has been made in accordance with the Technical Report TR 020 "Evaluation of anchorages in concrete concerning resistance to fire".

In addition to the specific clauses relating to dangerous substances contained in this European technical approval, there may be other requirements applicable to the products falling within its scope (e.g. transposed European legislation and national laws, regulations and administrative provisions). In order to meet the provisions of the Construction Products Directive, these requirements need also to be complied with, when and where they apply.

⁷ The technical documentation of this European technical approval is deposited at the Deutsches Institut für Bautechnik and, as far as relevant for the tasks of the approved bodies involved in the attestation of conformity procedure, is handed over to the approved bodies.

3 Evaluation and attestation of conformity and CE marking

3.1 System of attestation of conformity

According to the decision 97/161/EG of the European Commission⁸ the system 2(ii) (referred to as system 2+) of attestation of conformity applies.

This system of attestation of conformity is defined as follows:

System 2+: Declaration of conformity of the product by the manufacturer on the basis of:

- (a) Tasks for the manufacturer:
 - (1) initial type-testing of the product;
 - (2) factory production control;
 - (3) testing of samples taken at the factory in accordance with a prescribed control plan.
- (b) Tasks for the approved body:
 - (4) certification of factory production control on the basis of:
 - initial inspection of factory and of factory production control;
 - continuous surveillance, assessment and approval of factory production control.

Note: Approved bodies are also referred to as "notified bodies".

3.2 Responsibilities

3.2.1 Tasks for the manufacturer

3.2.1.1 Factory production control

The manufacturer shall exercise permanent internal control of production. All the elements, requirements and provisions adopted by the manufacturer shall be documented in a systematic manner in the form of written policies and procedures, including records of results performed. This production control system shall insure that the product is in conformity with this European technical approval.

The manufacturer may only use initial / raw / constituent materials stated in the technical documentation of this European technical approval.

The factory production control shall be in accordance with the control plan which is part of the technical documentation of this European technical approval. The control plan is laid down in the context of the factory production control system operated by the manufacturer and deposited with Deutsches Institut für Bautechnik.⁹

The results of factory production control shall be recorded and evaluated in accordance with the provisions of the control plan.

3.2.1.2 Other tasks of manufacturer

The manufacturer shall, on the basis of a contract, involve a body which is approved for the tasks referred to in section 3.1 in the field of anchors in order to undertake the actions laid down in section 3.2.2. For this purpose, the control plan referred to in sections 3.2.1.1 and 3.2.2 shall be handed over by the manufacturer to the approved body involved.

The manufacturer shall make a declaration of conformity, stating that the construction product is in conformity with the provisions of this European technical approval.

⁸ Official Journal of the European Communities L 67 of 03.02.1997

⁹ The control plan is a confidential part of the European technical approval and only handed over to the approved body involved in the procedure of attestation of conformity. See section 3.2.2.

3.2.2 Tasks for the approved bodies

The approved body shall perform the

- initial inspection of factory and of factory production control,
 - continuous surveillance, assessment and approval of factory production control,
- in accordance with the provisions laid down in the control plan.

The approved body shall retain the essential points of its actions referred to above and state the results obtained and conclusions drawn in a written report.

The approved certification body involved by the manufacturer shall issue an EC certificate of conformity of the factory production control stating the conformity with the provisions of this European technical approval.

In cases where the provisions of the European technical approval and its control plan are no longer fulfilled the certification body shall withdraw the certificate of conformity and inform Deutsches Institut für Bautechnik without delay.

3.3 CE marking

The CE marking shall be affixed on each packaging of the anchor. The letters "CE" shall be followed by the identification number of the approved certification body, where relevant, and be accompanied by the following additional information:

- the name and address of the producer (legal entity responsible for the manufacture),
- the last two digits of the year in which the CE marking was affixed,
- the number of the EC certificate for the factory production control,
- the number of the European technical approval,
- the number of the guideline for European technical approval (ETAG 001-6),
- size.

4 Assumptions under which the fitness of the product for the intended use was favourably assessed

4.1 Manufacturing

The European technical approval is issued for the product on the basis of agreed data/information, deposited with the Deutsches Institut für Bautechnik, which identifies the product that has been assessed and judged. Changes to the product or production process, which could result in this deposited data/information being incorrect, should be notified to the Deutsches Institut für Bautechnik before the changes are introduced. Deutsches Institut für Bautechnik will decide whether or not such changes affect the approval and consequently the validity of the CE marking on the basis of the approval and if so whether further assessment or alterations to the approval shall be necessary.

4.2 Design of anchorages

The fitness of the anchor for the intended use is given under the following conditions:

The anchorages are designed in accordance with the

- EOTA ETAG 001 Annex C "Design methods for anchorages" or in accordance with the
- CEN/TS 1992-4-4 "Design of fastenings for use in concrete", Part 4-4: "Post-installed fasteners - mechanical systems",

under the responsibility of an engineer experienced in anchorages and concrete work.

Verifiable calculation notes and drawings are prepared taking account of the loads to be anchored.

The position of the anchor is indicated on the design drawings (e.g. position of the anchor relative to reinforcement or to supports).

The design of the fixture is such that in case of excessive slip or failure of one anchor the load can be transmitted to neighbouring anchors.

The design of anchorages under fire exposure has to consider the conditions given in the Technical Report TR 020 "Evaluation of anchorages in concrete concerning resistance to fire". The relevant characteristic values are given in the Annex. The design method covers anchors with a fire attack from one side only. If the fire attack is from more than one side, the design method may be taken only, if the edge distance of the anchor is $c \geq 300$ mm.

4.3 Installation of anchors

The fitness for use of the anchor can only be assumed if the anchor is installed as follows:

- Anchor installation carried out by appropriately qualified personnel and under the supervision of the person responsible for technical matters of the site.
- Use of the anchor only as supplied by the manufacturer without exchanging the components of an anchor.
- Anchor installation in accordance with the manufacturer's specifications and drawings and using the appropriate tools.
- Checks before placing the anchor to ensure that the strength class of the concrete in which the anchor is to be placed is in the range given and is not lower than that of the concrete to which the characteristic loads apply.
- Check of concrete being well compacted, e.g. without significant voids.
- Edge distances and spacing not less than the specified values without minus tolerances.
- Positioning of the drill holes without damaging the reinforcement.
- In case of aborted hole: new drilling at a minimum distance away of twice the depth of the aborted hole or smaller distance if the aborted drill hole is filled with high strength mortar and if under shear or oblique tension load it is not in the direction of load application.
- Cleaning of the hole of drilling dust.
- Anchor installation such that the effective setting depth is complied with. This compliance is ensured, if the admissible thickness of fixture is kept or the loop of MKT Nail Anchor N-O rests on the concrete surface.
- Installation torque is not required for functioning of the anchor. However, the maximum tightening torque given in Annex 2 must not be exceeded.

5 Indications to the manufacturer

The manufacturer is responsible to ensure that the information on the specific conditions according to 1 and 2 including Annexes referred to and 4.2 and 4.3 is given to those who are concerned. This information may be made by reproduction of the respective parts of the European technical approval. In addition all installation data shall be shown clearly on the package and/or on an enclosed instruction sheet, preferably using illustration(s).

The minimum data required are:

- drill bit diameter,
- minimum effective anchorage depth,
- minimum hole depth,
- maximum thickness of fixture for the anchor type,
- information on the installation procedure, preferably by means of an illustration,
- reference to any special installation equipment needed,
- identification of the manufacturing batch.

All data shall be presented in a clear and explicit form.

Georg Feistel
Head of Department

beglaubigt:
Lange

**Only for multiple use in non-structural applications according to
ETAG 001 part 6 Annex 1**

Anchor versions:

N 6
Thread M6

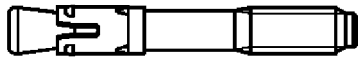

N 8
Thread M8

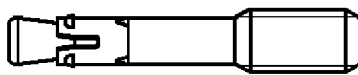

N-K
Nail head

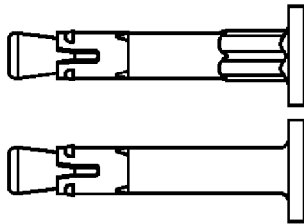

N-M
Coupling Nut
M8/M10

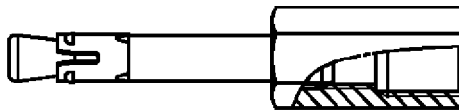

N-O
Loop

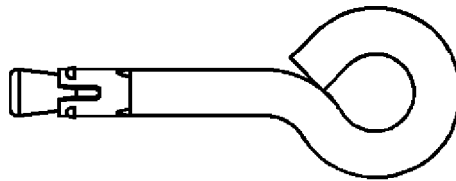

Marking of length
e.g.: B
see table below

Marking e.g.:

N6: N 6 5/10 | N 6 5 A4
N8, N-M: N 8 5/10 | N 8 5 A4

N-K:

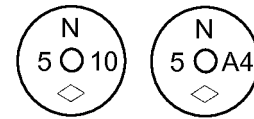

- Manufacturer identification
- N Anchor identity
- 6 Thread size M6
- 8 Thread size M8
- 5 Max. thickness of fixture for $h_{ef} = 30$ mm
- 10 Max. thickness of fixture for $h_{ef} = 25$ mm (Steel, zinc plated only)

N-O: N O

O Anchor version: Loop

A4 Additional marking of stainless steel A4
HCR Additional marking of high corrosion resistant steel HCR

Anchor identifier	Shank embossment		Thickness of fixture at $h_{ef} =$	
	Steel zinc plated, A4, HCR	Steel zinc plated only	30 mm	25 mm
A	0	/ 5	0	5
B	5	/ 10	5	10
C	10	/ 15	10	15
D	15	/ 20	15	20
E	20	/ 25	20	25
F	25	/ 30	25	30
G	30	/ 35	30	35
H	35	/ 40	35	40
I	40	/ 45	40	45
J	45	/ 50	45	50
K	50	/ 55	50	55
L	55	/ 60	55	60
M	60	/ 65	60	65

Anchor identifier	Shank embossment		Thickness of fixture at $h_{ef} =$	
	Steel zinc plated, A4, HCR	Steel zinc plated only	30 mm	25 mm
N	65	/ 70	65	70
O	70	/ 75	70	75
P	75	/ 80	75	80
Q	80	/ 85	80	85
R	85	/ 90	85	90
S	90	/ 95	90	95
T	95	/ 100	95	100
U	100	/ 105	100	105
V	105	/ 110	105	110
W	110	/ 115	110	115
X	115	/ 120	115	120
Y	120	/ 125	120	125
Z	125	/ 130	125	130

MKT Nail Anchor N

Product versions

Annex 1

Table 1: Installation parameters

Anchor type	Steel zinc plated				A4 / HCR			
	N 6 N-K N-O	N 8 N-M	N 6 N-K	N 8 N-M	N 6 N-K N-O	N 8 N-M		
Effective anchorage depth	$h_{ef} \geq$	[mm]	25		30		30	
Nominal drill hole diameter	d_0	[mm]	6	6	6	6	6	6
Cutting diameter of drill bit	$d_{cut} \leq$	[mm]	6,40	6,40	6,40	6,40	6,40	6,40
Depth of drill hole	$h_1 \geq$	[mm]	35	35	40	40	40	40
Diameter of clearance hole in the fixture	$d_f \leq$	[mm]	7	9	7	9	7	9
Maximum tightening torque (N 6 and N 8 only)	$T_{inst} \leq$	[mm]	4	4	4	4	4	4
Minimum member thickness	h_{min}	[mm]	80	80	80	80	80	80

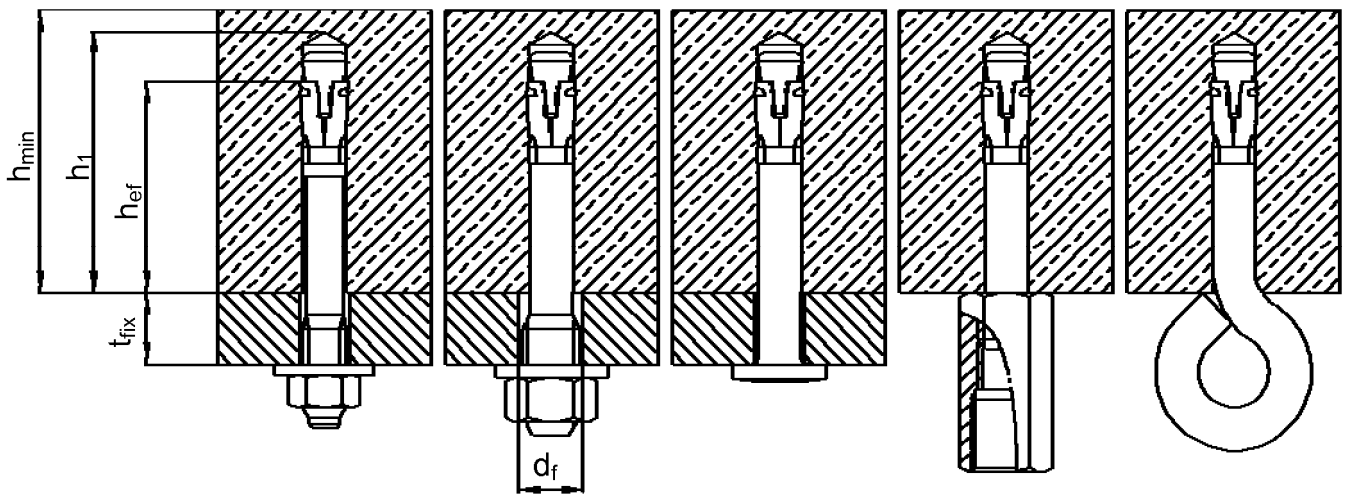

MKT Nail Anchor N

**Installation parameters,
Intended use**

Annex 2

Installation instructions

N 6 / N 8

N-K

N-M

N-O

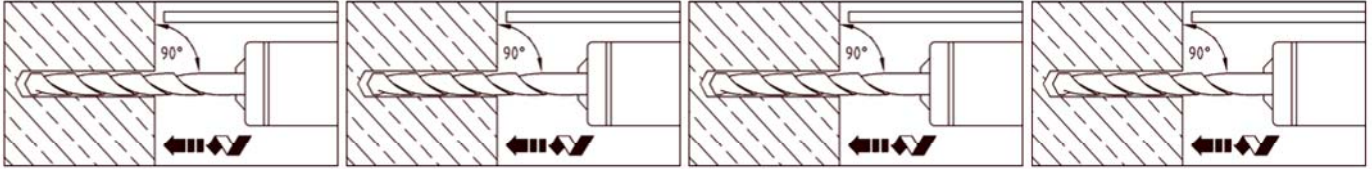

1. Drill hole perpendicular to concrete surface.

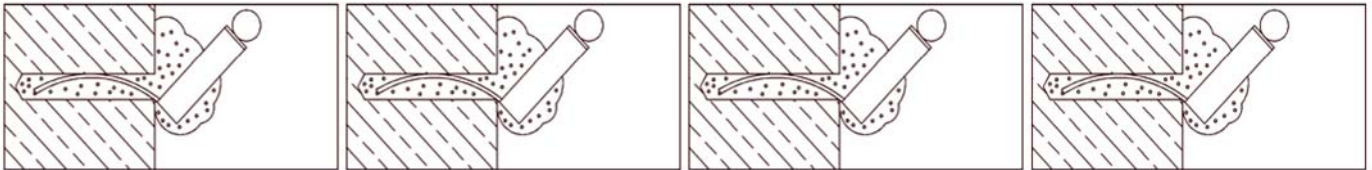

2. Blow out dust.

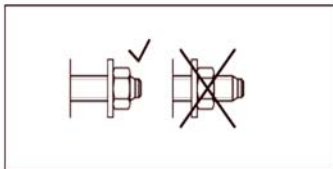

3. Check position of nut.

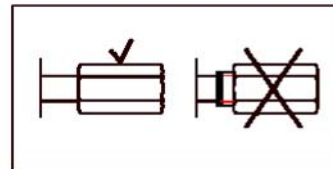

3. Check position of coupling nut.

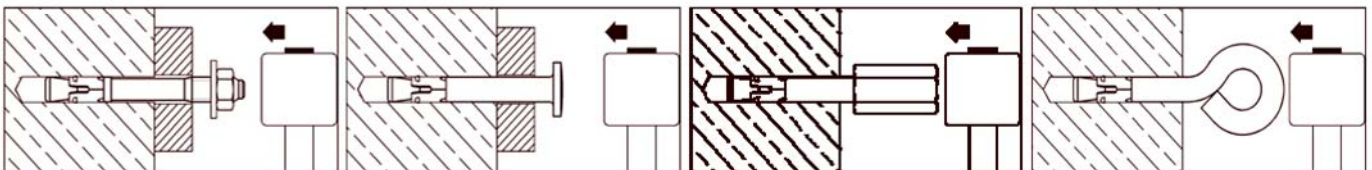

4. Drive in anchor.

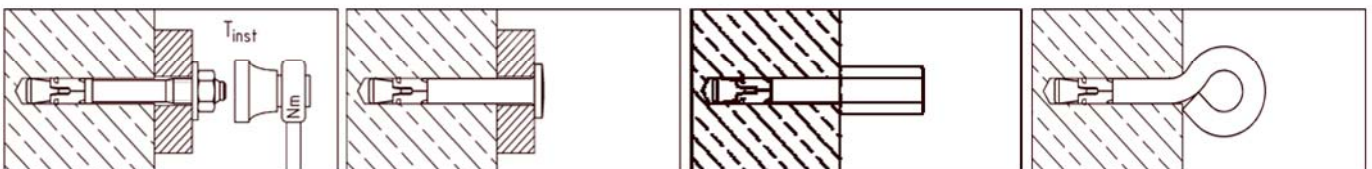

5. Max. tightening torque
 $T_{inst} \leq 4 \text{ Nm}$ may be
applied by using torque
wrench.

MKT Nail Anchor N

Installation instructions

Annex 3

Table 2: Characteristic and design resistance for a fixing point¹⁾, Design method C

Anchor types			Steel, zinc plated					A4 / HCR			
			N 6	N 8 N-K N-M	N 6	N 8 N-K N-M	N-O	N 6	N 8 N-K N-M	N-O	
Effective anchorage depth	$h_{ef} \geq$	[mm]	25		30		25		30		
Partial safety factor for any direction	γ_M	-	1,5								
Optimized for maximum load											
Characteristic resistance C12/15	F_{Rk}	[kN]	3,0	3,0 ⁴⁾	4,0	4,0 ⁴⁾	1,5	4,0	4,0 ⁴⁾	1,5	
Characteristic resistance C20/25 to C50/60			4,5	4,5 ⁴⁾	5,9	5,9 ⁴⁾		5,9	5,9 ⁴⁾		
Design resistance C12/15	F_{Rd}	[kN]	2,0	2,0 ⁴⁾	2,7	2,7 ⁴⁾	1,0	2,7	2,7 ⁴⁾	1,0	
Design resistance C20/25 to C50/60			3,0	3,0 ⁴⁾	3,9	3,9 ⁴⁾		3,9	3,9 ⁴⁾		
Respective spacing between fixing points ^{1) 2)}	$\frac{s_{cr}}{for\ C_{cr} \geq}$	[mm]	100								
			200								
Respective edge distance ²⁾	$\frac{C_{cr}}{for\ s_{cr} \geq}$	[mm]	100								
			200								
Optimized for minimum edge distance											
Characteristic resistance C12/15	F_{Rk}	[kN]	1,5	1,5 ⁴⁾	2,0	2,0 ⁴⁾	1,5	2,0	2,0 ⁴⁾	1,5	
Characteristic resistance C20/25 to C50/60			2,0	2,0 ⁴⁾	2,5	2,5 ⁴⁾		2,5	2,5 ⁴⁾		
Design resistance C12/15	F_{Rd}	[kN]	1,0	1,0 ⁴⁾	1,3	1,3 ⁴⁾	1,0	1,3	1,3 ⁴⁾	1,0	
Design resistance C20/25 to C50/60			1,3	1,3 ⁴⁾	1,7	1,7 ⁴⁾		1,7	1,7 ⁴⁾		
Respective spacing between fixing points ¹⁾	$\frac{C_{cr}}{for\ s_{cr} \geq}$	[mm]	50								
			100								
Shear load with lever arm											
Characteristic resistance	$M_{Rk,s}^0$	[Nm]	9,2	12,7	9,2	12,7	³⁾	9,2	13,5	³⁾	
Partial safety factor	γ_{Ms}^1	-	1,25								

1) A fixing point is defined as:

- Single anchor,
- Double anchor group with a minimum spacing s of $50\text{ mm} \leq s \leq 100\text{ mm}$ or
- Quadruple anchor group with a minimum spacing s of $50\text{ mm} \leq s \leq 100\text{ mm}$

If the spacing in a fixing point is greater than or equal to the respective spacing in this table, the characteristic resistances apply to every single anchor.

2) Intermediate values can be linearly interpolated.

3) Proof against failure due to shear load with lever arm is not required.

4) When applying a shear load to anchor version N-M, shear load with lever arm must be proven.

MKT Nail Anchor N

**Characteristic and design resistance for a fixing point,
Design method C**

Annex 4

Table 3: Characteristic resistance for a fixing point¹⁾ under fire exposure in concrete C20/25 to C50/60, Design method C

Fire resistance class	Steel, zinc plated								A4 / HCR					
	N 6 N 8	N-K	N-M ³⁾	N 6 N 8	N-K	N-M ³⁾	N-O	N 6 N 8	N-K	N-M ³⁾	N-O			
Effective anchorage depth	$h_{ef} \geq$	[mm]	25			30			25				30	
Load in any direction														
R 30	Characteristic resistance	$F_{Rk,fi}$	[kN]	0,6	0,6	0,6	0,9	0,9	0,8	0,2	0,9	0,9	0,8	0,2
R 60				0,6	0,6	0,6	0,7	0,8	0,7	0,2	0,9	0,9	0,7	0,2
R 90				0,5	0,6	0,6	0,5	0,6	0,6	0,1	0,9	0,9	0,6	0,1
R120				0,4	0,5	0,5	0,4	0,5	0,6	0,1	0,7	0,7	0,6	0,1
R 30 – R 120	Edge distance	$c_{cr,fi}$	[mm]	50										
	Spacing	$s_{cr,fi}$	[mm]	100										
Shear load with lever arm														
R 30	Characteristic resistance	$M^0_{Rk,fi}$	[Nm]	0,7	1,0	0,7	0,7	1,0	0,7	²⁾	1,4	2,1	0,7	²⁾
R 60				0,5	0,8	0,7	0,5	0,8	0,7	²⁾	1,1	1,5	0,7	²⁾
R 90				0,4	0,5	0,6	0,4	0,5	0,6	²⁾	0,7	1,0	0,6	²⁾
R120				0,3	0,4	0,5	0,3	0,4	0,5	²⁾	0,5	0,7	0,5	²⁾

If the fire attack is from more than one side, the edge distance shall be ≥ 300 mm.

¹⁾ A fixing point is defined as:

- Single anchor,
- Double anchor group with a minimum spacing s of $50 \text{ mm} \leq s \leq 100 \text{ mm}$ or
- Quadruple anchor group with a minimum spacing s of $50 \text{ mm} \leq s \leq 100 \text{ mm}$

If the spacing in a fixing point is greater than or equal to the respective spacing in this table, the characteristic resistances apply to every single anchor.

²⁾ Proof against failure due to shear load with lever arm is not required.

³⁾ Only in connection with threaded rods M8 or M10, minimum strength class 5.8.

MKT Nail Anchor N

**Characteristic resistance under fire exposure for a fixing point,
Design method C**

Annex 5