



## European Technical Approval ETA-11/0307

English translation prepared by DIBt - Original version in German language

Handelsbezeichnung <i>Trade name</i>	Bolzentreppe System Treppenmeister <i>Load-bearing bolt stair system Treppenmeister</i>
Zulassungsinhaber <i>Holder of approval</i>	Treppenmeister GmbH Emminger Straße 38 71131 Jettingen DEUTSCHLAND
Zulassungsgegenstand und Verwendungszweck <i>Generic type and use of construction product</i>	Fertigteiltreppe mit Trittstufen aus Massivholz oder Holzwerkstoff und Tragbolzen zur Verwendung als innen liegende Treppe in Gebäuden <i>Pre-fabricated stair with steps made of solid wood or wood-based products and load-bearing bolts for use as an indoor stair in buildings</i>
Geltungsdauer: <i>Validity:</i>	vom <i>from</i> bis <i>to</i> 11 June 2013 6 September 2016
Herstellwerk <i>Manufacturing plant</i>	Treppenmeister Werk 1 bis 85

Diese Zulassung umfasst  
*This Approval contains*

16 Seiten einschließlich 8 Anhänge  
*16 pages including 8 annexes*

Diese Zulassung ersetzt  
*This Approval replaces*

ETA-11/0307 mit Geltungsdauer vom 06.09.2011 bis 06.09.2016  
*ETA-11/0307 with validity from 06.09.2011 to 06.09.2016*

## I LEGAL BASES AND GENERAL CONDITIONS

- 1 This European technical approval is issued by Deutsches Institut für Bautechnik in accordance with:
  - Council Directive 89/106/EEC of 21 December 1988 on the approximation of laws, regulations and administrative provisions of Member States relating to construction products<sup>1</sup>, modified by Council Directive 93/68/EEC<sup>2</sup> and Regulation (EC) N° 1882/2003 of the European Parliament and of the Council<sup>3</sup>;
  - *Gesetz über das In-Verkehr-Bringen von und den freien Warenverkehr mit Bauprodukten zur Umsetzung der Richtlinie 89/106/EWG des Rates vom 21. Dezember 1988 zur Angleichung der Rechts- und Verwaltungsvorschriften der Mitgliedstaaten über Bauprodukte und anderer Rechtsakte der Europäischen Gemeinschaften (Bauproduktengesetz - BauPG) vom 28. April 1998<sup>4</sup>, as amended by Article 2 of the law of 8 November 2011<sup>5</sup>;*
  - Common Procedural Rules for Requesting, Preparing and the Granting of European technical approvals set out in the Annex to Commission Decision 94/23/EC<sup>6</sup>;
  - Guideline for European technical approval of "Prefabricated stair kits - Part 1: Prefabricated stair kits in general (excluding severe climatic conditions)", ETAG 008-01.
- 2 Deutsches Institut für Bautechnik is authorized to check whether the provisions of this European technical approval are met. Checking may take place in the manufacturing plant. Nevertheless, the responsibility for the conformity of the products to the European technical approval and for their fitness for the intended use remains with the holder of the European technical approval.
- 3 This European technical approval is not to be transferred to manufacturers or agents of manufacturers other than those indicated on page 1, or manufacturing plants other than those indicated on page 1 of this European technical approval.
- 4 This European technical approval may be withdrawn by Deutsches Institut für Bautechnik, in particular pursuant to information by the Commission according to Article 5(1) of Council Directive 89/106/EEC.
- 5 Reproduction of this European technical approval including transmission by electronic means shall be in full. However, partial reproduction can be made with the written consent of Deutsches Institut für Bautechnik. In this case partial reproduction has to be designated as such. Texts and drawings of advertising brochures shall not contradict or misuse the European technical approval.
- 6 The European technical approval is issued by the approval body in its official language. This version corresponds fully to the version circulated within EOTA. Translations into other languages have to be designated as such.

<sup>1</sup> Official Journal of the European Communities L 40, 11 February 1989, p. 12  
<sup>2</sup> Official Journal of the European Communities L 220, 30 August 1993, p. 1  
<sup>3</sup> Official Journal of the European Union L 284, 31 October 2003, p. 25  
<sup>4</sup> *Bundesgesetzblatt Teil I 1998*, p. 812  
<sup>5</sup> *Bundesgesetzblatt Teil I 2011*, p. 2178  
<sup>6</sup> Official Journal of the European Communities L 17, 20 January 1994, p. 34

## II SPECIFIC CONDITIONS OF THE EUROPEAN TECHNICAL APPROVAL

### 1 Definition of the product and intended use

#### 1.1 Definition of the construction product

The Load-bearing bolt stair system Treppenmeister is a prefabricated stair system (hereinafter referred to as stair), which consists of steps, load-bearing bolts and wall ties. The stair can also be formed as a folded plate stair by additional risers.

The steps of the WF2-stair are connected with each other by one load-bearing bolt on the wall-free side and one load-bearing bolt on the wall side. On the wall side each step is equipped with one or two walls tie, which are anchored in the staircase wall. The steps of the WE1-stair are connected with each other by one load-bearing bolt on the wall-free side. On the wall side each step is equipped with two walls tie, which are anchored in the staircase wall. Alternatively, the staircase wall may also be replaced by a string or a cut string.

The steps and risers are either made of solid wood or wood-based products. The load-bearing bolts are made of solid wood and steel, the fasteners and wall ties are made of steel.

Handrail and barrier are not part of the stair system, but may be attached to the stair optionally according to the individual requirements.

Annex 1 and 2 shows the stair with its types of construction and its types of plan. According to the types of plan it is to be distinguished between stairs with straight flights, stairs with one quarter turn, with twice a quarter turn, with half a turn and circular arc stairs.

#### 1.2 Intended use

The stair may be used as an indoor stair in buildings with air temperatures between +5 °C and +30 °C and relative air humidity between 30 % and 70 %.

The European technical approval covers a construction system. For the specific case of use the corresponding type of stair is manufactured within the context of the values defined in the European technical approval. The values apply to all types of stairs, the real dimensions follow in accordance with the relevant case of use.

The provisions made in this European technical approval are based on an assumed working life of the stair of 50 years; provided that the conditions laid down in sections 4 and 5 are met. The indications given on the working life cannot be interpreted as a guarantee given by the producer, but are to be regarded only as a means for choosing the right products in relation to the expected economically reasonable working life of the works.

### 2 Characteristics of the product and methods of verification

#### 2.1 General

The stair corresponds to the drawings and data of the annexes. The material values, dimensions and tolerances of the components of the stair not indicated in the annexes shall correspond to the values laid down in the technical documentation<sup>7</sup> of this European technical approval.

<sup>7</sup> The technical documentation comprises all information of the holder of this ETA necessary for the production, installation and maintenance of the stair; these are in particular the structural analysis, design drawings and the manufacturer's installation instructions. The part to be treated confidentially is deposited with Deutsches Institut für Bautechnik and, as far as this is relevant to the tasks of the approved bodies involved in the procedure of attestation of conformity, shall be handed over to the approved body.

## 2.2 Mechanical resistance and stability

### 2.2.1 General

The stair has a sufficient mechanical resistance and stability in order to resist static or quasi-static loads.

The characteristic values of resistance of the stair given in Annex 8, Table 4 were determined by loading tests and by structural analysis. The structural analysis is an integral part of the technical documentation of this European technical approval.

### 2.2.2 Prevention of progressive collapse

Failure of individual components of the stair does not lead to a progressive collapse of the complete stair.

### 2.2.3 Residual load-bearing capacity

The stair loaded by service loads stated in Annex 8, Table 6 has a sufficient residual load-bearing capacity. A local material failure does not lead to an abrupt total loss of load-bearing capacity of the stair.

### 2.2.4 Long-term behaviour

The characteristic values of resistance stated in Annex 8, Table 4 are ensured under an appropriate use and maintenance over the indicated working life.

### 2.2.5 Resistance to earthquakes

No performance determined (NPD).

### 2.2.6 Load/displacement behaviour and vibration behaviour

The characteristic values concerning the load/displacement behaviour were determined by calculation. The values determined are given in Annex 8, Table 5.

The vibration behaviour was determined by calculation. The stair shows under a single load of  $F = 1,0$  kN acting on the most unfavourable point at the wall-free side a deflection of  $w \leq 5$  mm. The first natural frequency of the stair (inclusive a single mass of 100 kg) is greater than 5 Hz.

### 2.2.7 Resistance of the fixings

The characteristic loads which are passed on by the fasteners (wall ties, additional supports and fixings for the bottom step and the top step) to the construction works are given in the technical documentation to this European technical approval.

## 2.3 Safety in case of fire

### 2.3.1 Reaction to fire

The classification of the reaction to fire of the components of the stair is given in Annex 5, Table 1.

### 2.3.2 Fire resistance

No performance determined (NPD).

## 2.4 Hygiene, health and the environment

According to the manufacturer's declaration, taking account of the EU database<sup>8</sup>, the stair does not contain any dangerous substances. The wood-based panels used fulfil the class E1 according to EN 13986.

In addition to the specific clauses relating to dangerous substances contained in this European technical approval, there may be other requirements applicable to the products falling within its scope (e.g. transposed European legislation and national laws, regulations and administrative provisions). In order to meet the provisions of the Construction Products Directive, these requirements need also to be complied with, when and where they apply.

<sup>8</sup> Notes are stated in Guidance Paper H: "A harmonized approach relating to dangerous substances under the Construction Products Directive", Brussels, September 2002.

## 2.5 Safety in use

### 2.5.1 Geometry of the stair

The geometry of the stair is stated in Annex 7. The position of the constant pitch line / walking line is exemplified in Annex 2. The position of the walking line may be chosen freely within the walking zone. The walking zone is 20 % of the clear width of the stair and is located in the middle of the stair flight.

### 2.5.2 Slipperiness

No performance determined (NPD).

### 2.5.3 Equipment of the stair for a safe use

Barrier and handrail:

Barrier and handrail are not part of the stair system.

Note: If barrier and handrail shall be attached to the stair, the conditions of Annex 8, Table 4 of this European technical approval apply concerning the static requirements. The construction of the connection between barrier and step is given in the technical documentation to this European technical approval.

Tactility and visibility:

No performance determined (NPD).

### 2.5.4 Safe breakage of components

A brittle failure of individual components is excluded.

### 2.5.5 Impact resistance

No performance determined (NPD).

## 2.6 Durability and serviceability

### 2.6.1 Resistance to deterioration caused by physical, chemical and biological agents

Under an appropriate use and maintenance and at an indoor climate with air temperatures between +5°C and +30°C and relative air humidity between 30 % and 70 % the stair will have for the intended use an adequate resistance to

- physical agents like effects of temperature, radiation of sun and variations of relative humidity,
- chemical agents like effects of cleaning agents, water, carbon dioxide, oxygen and naturally occurring corrosives and pollution agents and
- biological agents like effects of fungi, bacteria, algae and insects.

### 2.6.2 Finishes and surface layers

All components made of solid wood (steps, risers, strings and cut strings) are coated with varnish on all sides or they are oiled. Steps made of wood based products with a surface of veneer are untreated.

## 3 Evaluation and attestation of conformity and CE marking

### 3.1 System of attestation of conformity

According to the Decision 99/89/EC of the European Commission<sup>9</sup> the System 2+ of attestation of conformity applies.

In addition, according to the Decision 2001/596/EC of the European Commission<sup>10</sup> the System 4 of attestation of conformity applies with regard to reaction to fire.

<sup>9</sup> Official Journal of the European Communities L .29 of 03.02.1999

<sup>10</sup> Official Journal of the European Communities L 209/33 of 02.08.2001

These systems of attestation of conformity are defined as follows:

System 2+: Declaration of conformity of the product by the manufacturer on the basis of:

(a) Tasks for the manufacturer:

- (1) initial type-testing of the product;
- (2) factory production control;
- (3) testing of samples taken at the factory in accordance with a prescribed control plan.

(b) Tasks for the approved body:

- (4) certification of factory production control on the basis of:
  - initial inspection of factory and of factory production control;
  - continuous surveillance, assessment and approval of factory production control.

System 4: Declaration of conformity of the product by the manufacturer on the basis of:

Tasks for the manufacturer:

- (1) initial type-testing of the product;
- (2) factory production control.

*Note: Approved bodies are also referred to as "notified bodies".*

## 3.2 Responsibilities

### 3.2.1 Tasks of the manufacturer

#### 3.2.1.1 Factory production control

The manufacturer shall exercise permanent internal control of production. All the elements, requirements and provisions adopted by the manufacturer shall be documented in a systematic manner in the form of written policies and procedures, including records of results performed. This production control system shall insure that the product is in conformity with this European technical approval.

The manufacturer may only use initial materials and components stated in the technical documentation of this European technical approval.

The factory production control shall be in accordance with the control plan<sup>11</sup> which is part of the technical documentation of this European technical approval. The control plan is laid down in the context of the factory production control system operated by the manufacturer and deposited at Deutsches Institut für Bautechnik.

The results of factory production control shall be recorded and evaluated in accordance with the provisions of the control plan.

#### 3.2.1.2 Other tasks of manufacturer

The manufacturer shall, on the basis of a contract, involve a body which is approved for the tasks referred to in section 3.1 in the field of stairs in order to undertake the actions laid down in section 3.2.2. For this purpose, the control plan referred to in sections 3.2.1.1 and 3.2.2 shall be handed over by the manufacturer to the approved body involved.

The manufacturer shall make a declaration of conformity, stating that the construction product is in conformity with the provisions of this European technical approval.

<sup>11</sup> The control plan is a confidential part of the European technical approval and only handed over to the approved body involved in the procedure of attestation of conformity. See section 3.2.2.

### 3.2.2 Tasks of approved bodies

The approved body shall perform the following tasks in accordance with the provisions laid down in the control plan:

- initial inspection of factory and of factory production control,
- continuous surveillance, assessment and approval of factory production control.

The approved body shall retain the essential points of its actions referred to above and state the results obtained and conclusions drawn in a written report.

The approved certification body involved by the manufacturer shall issue an EC certificate of conformity of the factory production control stating the conformity with the provisions of this European technical approval.

In cases where the provisions of the European technical approval and its control plan are no longer fulfilled the certification body shall withdraw the certificate of conformity and inform Deutsches Institut für Bautechnik without delay.

### 3.3 CE marking

The CE marking shall be affixed on a label attached to the stair or on the accompanying commercial documents (e.g. the EC declaration of conformity). The letters "CE" shall be followed by the identification number of the approved certification body, where relevant, and be accompanied by the following additional information:

- name or identifying mark and address of the producer of the stair (legal entity responsible for the manufacturer),
- identification of the stair (trade name),
- the last two digits of the year in which the CE marking was affixed,
- number of the EC certificate of conformity for the factory production control,
- number of the European technical approval,
- ETAG 008, Part 1.

If the CE marking is affixed on the accompanying commercial documents, the following minimum information shall be given on a label attached to the stair:

- initials "CE" followed by the identification number of the certification body,
- name or identifying mark of the manufacturer of the stair (legal entity responsible for the manufacturer),
- identification of the stair (trade name),
- the last two digits of the year in which the CE marking was affixed.

## 4 Assumptions under which the fitness of the product for the intended use was favourably assessed

### 4.1 Manufacture

The European technical approval is issued for the product on the basis of agreed data/information, deposited with Deutsches Institut für Bautechnik, which identifies the product that has been assessed and judged. Changes to the product or production process, which could result in this deposited data/information being incorrect, should be notified to Deutsches Institut für Bautechnik before the changes are introduced.

Deutsches Institut für Bautechnik will decide whether or not such changes affect the approval and consequently the validity of the CE marking on the basis of the approval and if so whether further assessment or alterations to the approval shall be necessary.

#### 4.2 Design

The fitness for use of the stair is given under the following assumptions:

The stair is designed according to the drawings and data of the annexes and the technical documentation to this European technical approval.

The stair is fixed to the construction works according to the drawings and data of the annexes and the technical documentation to this European technical approval. The proof of the transmission of loads in the construction works are made by the civil engineer responsible for the construction works.

The load-bearing capacity of the stair at ultimate limit state is verified according to Annex 8, Table 4. The load-bearing capacity of the stair at serviceability limit state is verified according to Annex 8, Table 5.

#### 4.3 Installation

The fitness for use of the stair can be assumed only, if the following installation conditions are adhered to:

- installation by personnel appropriately trained and authorized by the holder of the approval by means of the technical documentation of this European technical approval,
- installation only in the way as specified in the technical documentation of this European technical approval,
- installation of the timber components when moisture content of the timber components is  $8 \pm 2 \%$ ,
- sufficient support of the stair when assembling,
- installation of parts of the stair without imposed deformations,
- installation of parts of the stair without significant defects and cracks,
- replacing of parts of the stair, which begin tearing when assembling,
- bolted connections are protected such that they will not be loosened by vibrations.

### 5 Indications to the manufacturer

#### 5.1 Manufacturer's responsibilities

It is the manufacturer's responsibility to make sure that all persons involved will be appropriately informed about the specific conditions according to sections 1, 2, 4.2 and 4.3 including the annexes to which reference is being made as well as the not confidential parts of the technical documentation deposited to this European technical approval.

#### 5.2 Recommendations regarding packaging, transport and storage

The components of wood and wood based products should be packed such that the wood moisture is  $8 \pm 2 \%$  during transport and storage.

#### 5.3 Recommendations regarding use, maintenance and repair

In his instructions for use the manufacturer should provide information as to use, maintenance and repair of the stair. At least the following information should be given:

- retighten the bolting of the load-bearing bolts and connections according to Annex 3 after the first heating season,
- no moisture penetration of the timber components.

Andreas Kummerow  
p. p. Head of Department

*beglaubigt:*  
Wittstock



### Types of construction

**WE1 (2 wall ties)**

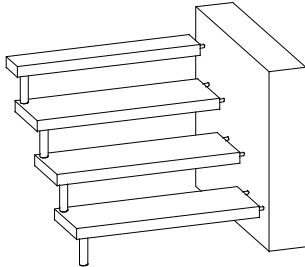

**WF2 (1 wall tie)**

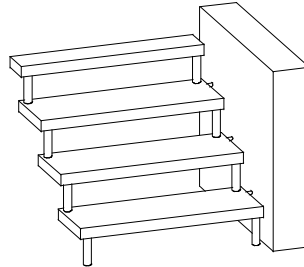

**WF2 (2 wall ties)**

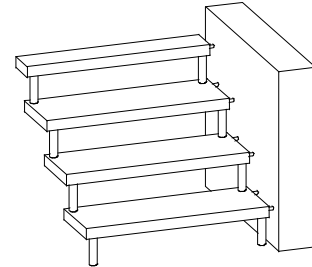

**WE1 (close string)**

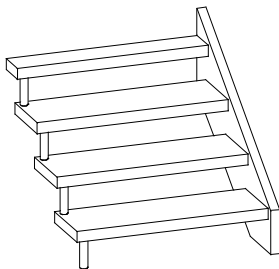

**WE1 (2 wall ties)**

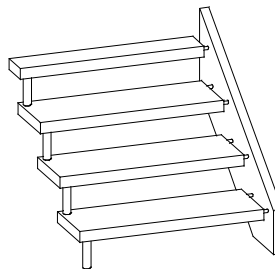

**WE1 (cut string)**

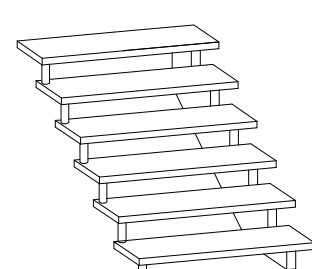

**WF2 (1 wall tie)**

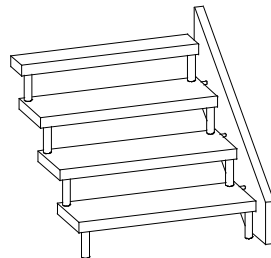

**WF2 (2 wall ties)**

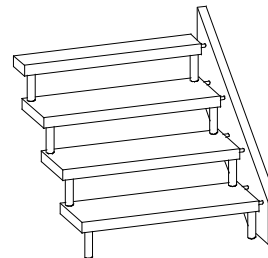

### Folded plate style

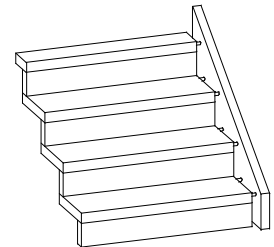
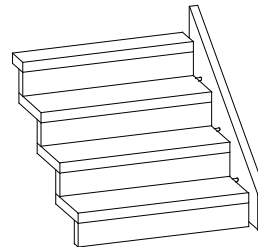
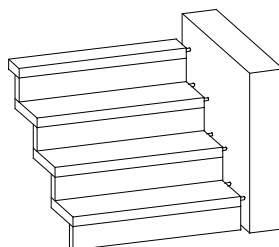
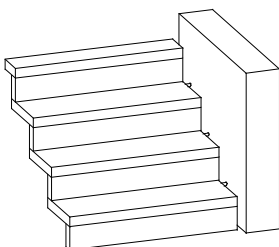

Support of the strings and cut strings on the wall side according to technical

### Load-bearing bolt stair system Treppenmeister

Product and intended use (Types of construction)

**Annex 1**

### Types of plan

Walking line exemplified, position may be chosen freely within the walking zone,  
walking zone is 20 % of the clear width of the stair in the middle of the stair

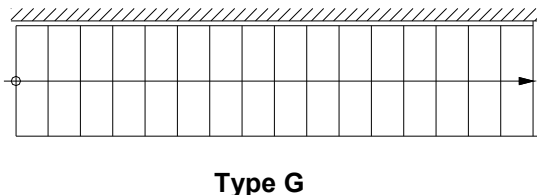
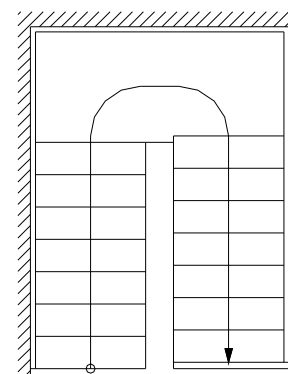
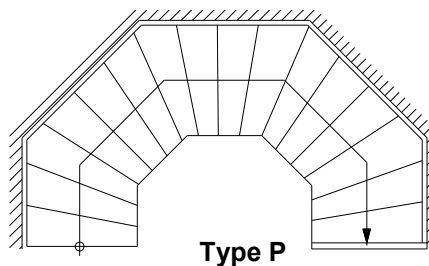
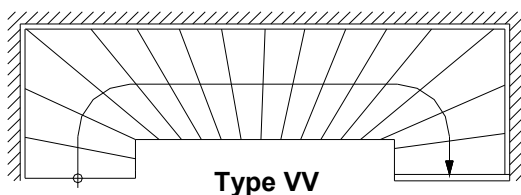
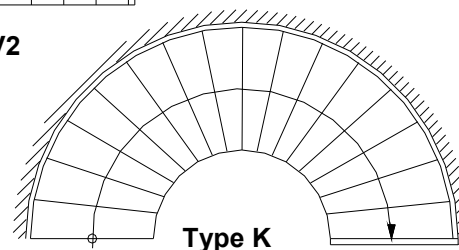
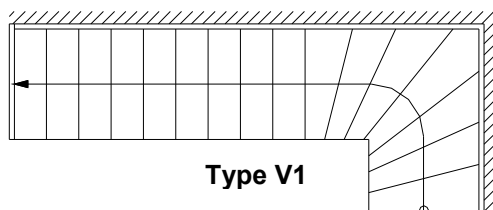
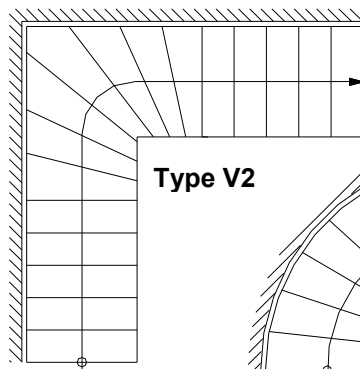
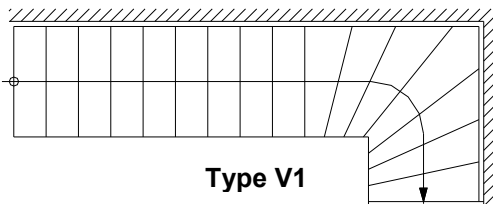

**Type G**

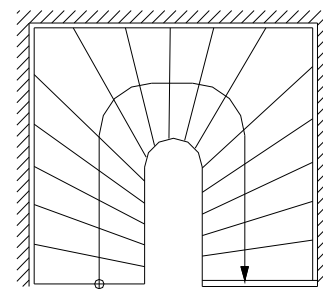
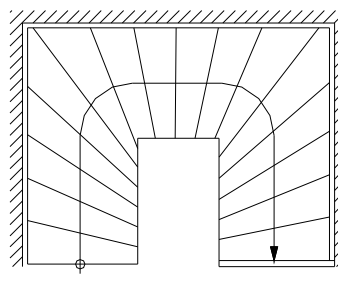
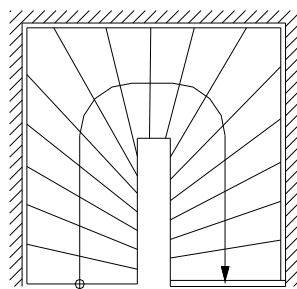

Additional support according to Annex 6

**Load-bearing bolt stair system Treppenmeister**

Product and intended use (Types of plan)

**Annex 2**

### Load-bearing bolts

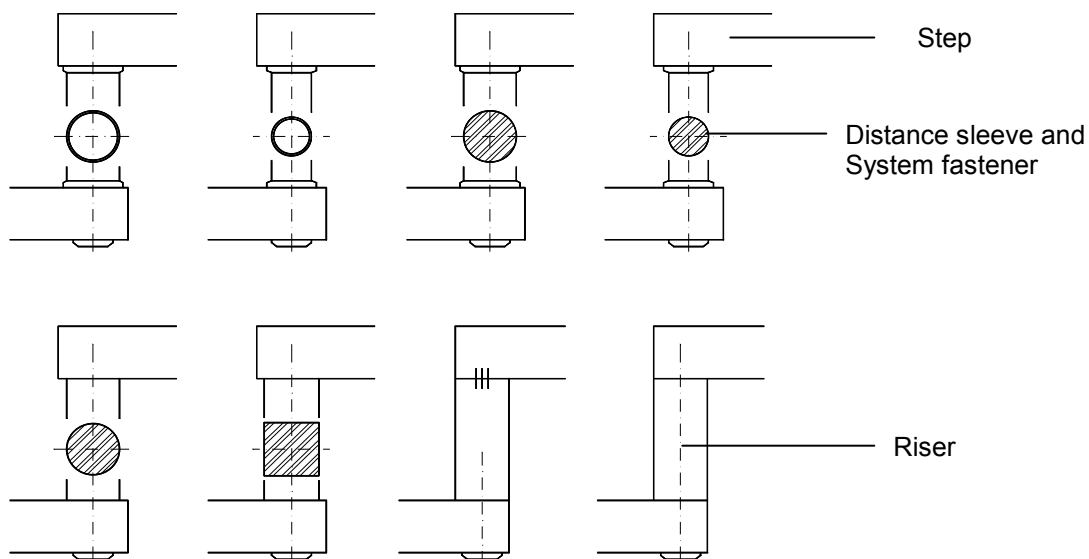

### Wall tie

Minimum wall thickness and minimum strength of the wall material as well as distances to the wall according to the technical documentation

Wall tie: angle

Wall tie: angle

Wall tie: bolt

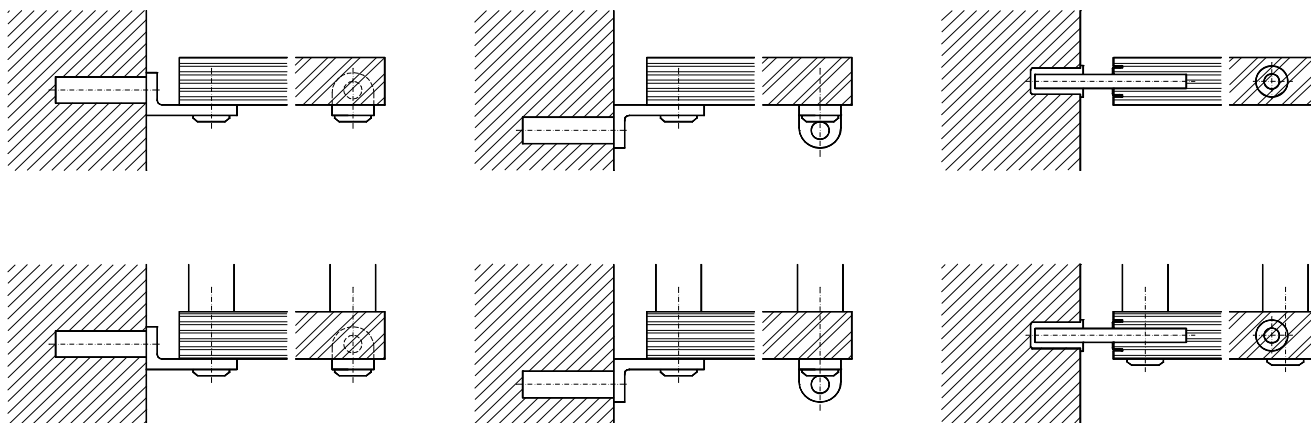

Further details according to the technical documentation

## Load-bearing bolt stair system Treppenmeister

Load-bearing bolts and wall ties

**Annex 3**

**Step – cut string - joint**

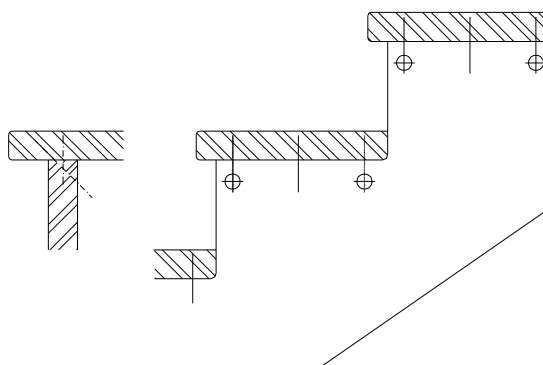

**Step – string - joint**

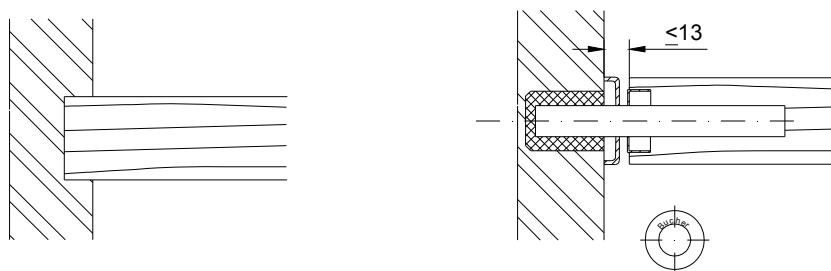

**Support  
bottom**

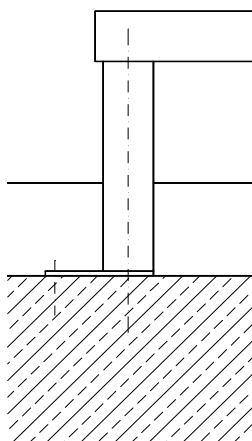

**Support  
at the top**

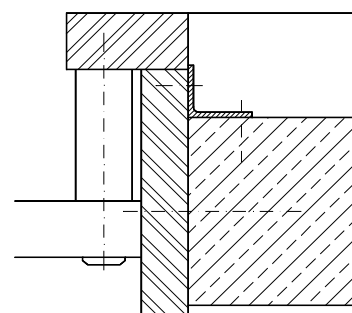

Further details according to the technical documentation

**Load-bearing bolt stair system Treppenmeister**

Step-string-joints, support bottom and at the top

**Annex 4**

**Table 1: Minimum dimensions of relevant stair components and reaction to fire**

Component	Material <sup>1)</sup>	Dimension		Value	Reaction to fire <sup>5)</sup>
Step	Solid wood <sup>2)</sup>	Thickness	[mm]	54 <sup>6)</sup>	D-s2, d0 (2003/593/EC)
	Wood-based product <sup>3)</sup>	Thickness	[mm]	54 <sup>6)</sup>	D-s2, d0 (2003/593/EC)
Riser	Solid wood <sup>2)</sup>	Thickness	[mm]	54 <sup>6)</sup>	D-s2, d0 (2003/593/EC)
Load-bearing bolt / rod	Steel	Diameter	[mm]	12	A1 (96/603/EC)
Load bearing bolt distance sleeve	Steel pipe	Diameter	[mm]	40 <sup>4)</sup>	
		Solid wood <sup>2)</sup>	Diameter	[mm]	40 <sup>4)</sup>
Wall tie (bolt)	Round steel	Diameter	[mm]	16	A1 (96/603/EC)
		Embedment depth Wall	[mm]	55	
		Embedment depth Step	[mm]	80	
Wall tie (angle)	Steel	Angle	[mm]	50x100x10	A1 (96/603/EC)
		Diameter screw	[mm]	10	
		Embedment depth Wall	[mm]	100	
Bearing sleeve for wall tie (bolt)	Plastics	Diameter	[mm]	30	not relevant
Bearing sleeve for wall tie (angle)	Plastics	Diameter	[mm]	30	not relevant
String	Solid wood <sup>2)</sup>	Width x thickness	[mm]	44 x 240...310 <sup>7)</sup>	D-s2, d0 (2003/593/EC)
Cut string	Solid wood <sup>2)</sup>	Width x thickness	[mm]	44 x 150...210 <sup>8)</sup>	

<sup>1)</sup> Characteristic values of material according to technical documentation

<sup>2)</sup> Only solid wood of following species:

Group 1: Amazakoué, Bangkirai, Bongossi, Beech, Oak, Ash, Merbau, Wengé, Zebrano

Group 2: Maple, Acacia, Birch, Bubinga, Cherry tree, Hevea, Nut tree, Teak

<sup>3)</sup> Beech with high-density fibreboard (equivalent to Group 2, layer composition according to technical documentation)

<sup>4)</sup> With washer d = 50 mm,

more details and assigning of load-bearing bolts – types of stairs according to technical documentation

<sup>5)</sup> According to the provisions of European Commission decisions

<sup>6)</sup> Types of plan K, P, VV without additional support,

all other types of plan with additional support according to Table 2

<sup>7)</sup> Dimensions according to ETA-10/0215

<sup>8)</sup> Dimensions according to ETA-13/0197

**Load-bearing bolt stair system Treppenmeister**

Minimum dimensions of relevant stair components  
and reaction to fire

**Annex 5**

**Table 2: Additional support for maximum clear width of the stair**

Construction		WE1		WF2		Folded plate
Wall tie		Bolt	Angle	Bolt	Angle	Bolt / Angle
Type	Rises	Required additional support on step				
G	≤ 17	3 + 7 + 12	5 + 11	5 + 11	5 + 11	1 + 9
	≤ 15	1 + 5 + 10	4 + 10	4 + 10	4 + 10	7
	≤ 14	4 + 9	2 + 8	2 + 8	2 + 8	6
	≤ 13	3 + 8	1 + 7	1 + 7	1 + 7	5
	≤ 12	2 + 7	6	6	6	4
	≤ 11	1 + 6	5	5	5	3
	≤ 10	5	4	4	4	2
	≤ 9	4	3	3	3	1
	≤ 8	3	2	2	2	-
	≤ 7	2	1	1	1	-
V1	≤ 17	5	4	4	4	2
	≤ 15	3	2	2	2	-
V2	≤ 17	4 + 14	1	4	3	3
	≤ 15	4	-	3	2	1
H	≤ 17	1	-	-	-	-
	≤ 15	-	-	-	-	-

<sup>1)</sup> Further possibilities of supports for smaller clear width of the stair according to technical documentation

**Load-bearing bolt stair system Treppenmeister**

Additional support

**Annex 6**

**Table 3: Geometry**

Designation			Dimension	
			Minimum	Maximum
Going	step on walking line <sup>1)</sup>	[mm]	210	370 <sup>2)</sup>
	tapered step	[mm]	70 <sup>2) 3)</sup>	600 <sup>2) 4)</sup>
Rise of the stairs <sup>1)</sup>		[mm]	140 <sup>2)</sup>	210
Pitch of the walking line <sup>1)</sup>		[°]	21	45
Overlap of the steps		[mm]	70 <sup>6)</sup>	- <sup>5)</sup>
Number of rises		[-]	3	17
Openings	between stairs and wall	[mm]	- <sup>5)</sup>	40
	between consecutive steps	[mm]	- <sup>5)</sup>	156
Clear width of stairs		[mm]	500	1000
Minimum headroom		[mm]	- <sup>5)</sup>	
Length of the flight		[mm]	- <sup>5)</sup>	4160
Thickness of steps		[mm]	54	- <sup>5)</sup>

- 1) Values are constant within one flight
- 2) Tolerance between nominal value and actual value = ± 5 mm
- 3) Wall-free side of tapered step
- 4) Wall side of tapered step
- 5) Not relevant
- 6) With riser overlap 0 mm

- 1 Going
- 2 Rise
- 3 Overlap
- 4 Opening between Consecutive steps
- 5 Length of the flight
- 6 Thickness of steps

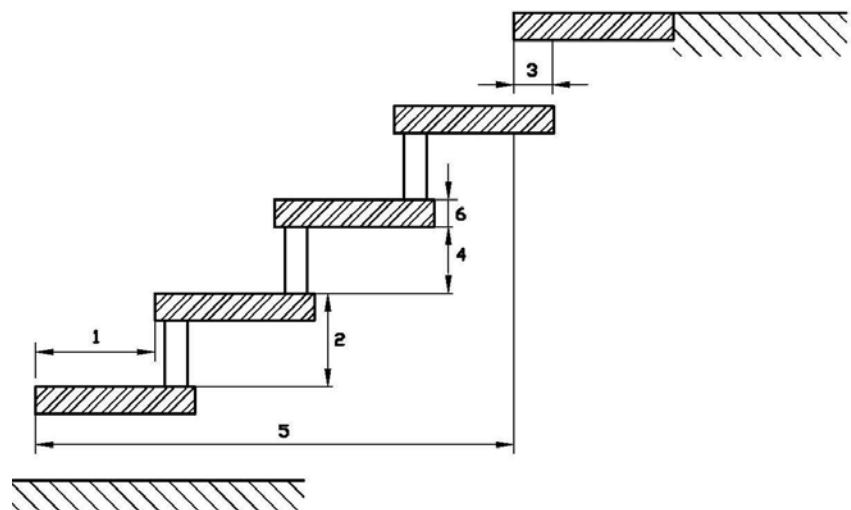

**Load-bearing bolt stair system Treppenmeister**

Geometry of the stair

**Annex 7**

**Table 4: Load-bearing capacity at ultimate limit state <sup>1)</sup> - Characteristic values of resistance  $R_k$**

Part of stair	Type of loading	Characteristic values of resistance			$\gamma_M$
Flight	vertical variable uniformly distributed load	$q_{RK}$	[kN/m <sup>2</sup> ]	6.75	1.5 <sup>2)</sup>
	vertical variable single load	$Q_{RK}$	[kN]	4.5	
	horizontal variable uniformly distributed load <sup>4)</sup>	$h_{RK}$	[kN/m]	0.8	
Support on the top	vertical variable uniformly distributed load	$q_{RK}$	[kN/m <sup>2</sup> ]	5.0	1.1 <sup>3)</sup>
	vertical variable single load	$Q_{RK}$	[kN]	3.3	
	horizontal variable uniformly distributed load <sup>4)</sup>	$h_{RK}$	[kN/m]	0.6	

<sup>1)</sup> Proof of ultimate limit state is only given if the design value of the actions does not exceed the design value of the resistance:  $F_d \leq R_d$  with  $F_d = F_k \cdot \gamma_F$  and  $R_d = R_k / \gamma_M$

$R_k$  and  $\gamma_M$  according to Table 4

$F_k$  = characteristic values of actions (imposed loads according to EN 1991-1-1)

$\gamma_F = 1.5$  (recommended partial safety factor, in absence of other national regulations)

<sup>2)</sup> Recommended partial safety factor (timber decisive), in absence of other national regulations

<sup>3)</sup> Recommended partial safety factor (steel decisive), in absence of other national regulations

<sup>4)</sup> Accompanying action ( $\psi_0 = 0.7$ , recommended combination factor, in absence of other national regulations); load acting on barrier; barrier and handrail are not part of the stair system.

Conditions for possible barrier/handrail:  $g \leq 0.15$  kN/m,  $h \leq 1.00$  m, distance of baluster  $\leq 0.26$  m

**Table 5: Load-bearing capacity at Serviceability limit state <sup>1)</sup> - Deflections under loading**

Deflection of the flight under uniformly distributed load			
load $F_S$	$q_S =$	3.0	[kN/m <sup>2</sup> ]
length of the median line of the flight	$l =$	4160 <sup>2)</sup>	[mm]
deflection under load $F_S$ related to the median line of the flight	$w \leq$	$l/200$	[-]
Deflection of the step under single point load			
load $F_S$	$Q_S =$	2.0	[kN]
clear width of the stair	$l =$	1000	[mm]
deflection under load $F_S$ related to the clear width of the stair	$w \leq$	$l/200$	[-]

<sup>1)</sup> Proof of serviceability limit state is only given if the characteristic value of the actions (imposed loads according to EN 1991-1-1) does not exceed the value  $F_S$  according to Table 5:  $F_k \leq F_S$

<sup>2)</sup>  $l$  = reference length = distance between supports (additional supports according to Annex 6)

**Table 7: Load-bearing capacity - Service loads <sup>1)</sup>**

minimum value from proof of ultimate limit state and serviceability limit state			
vertical variable uniformly distributed load	$q$	[kN/m <sup>2</sup> ]	3.0
vertical variable single load	$Q$	[kN]	2.0
horizontal variable uniformly distributed load <sup>2)</sup>	$h$	[kN/m]	0.5

<sup>1)</sup> Service load =  $\min(R_k / (\gamma_M \cdot \gamma_F); F_S)$  with  $R_k$ ,  $\gamma_M$ ,  $\gamma_F$  according to Table 4 and  $F_S$  according to Table 5

<sup>2)</sup> Load acting on barrier (see Table 4)

**Load-bearing bolt stair system Treppenmeister**

Load-bearing capacity at ultimate limit state,  
Load-bearing capacity at serviceability limit state,  
Load-bearing capacity – service loads

**Annex 8**