



## European Technical Approval ETA-12/0084

English translation prepared by DIBt - Original version in German language

Handelsbezeichnung  
*Trade name*

Injektionssystem Hilti HIT-HY 200-R  
*Injection system Hilti HIT-HY 200-R*

Zulassungsinhaber  
*Holder of approval*

Hilti Aktiengesellschaft  
9494 SCHAAN  
FÜRSTENTUM LIECHTENSTEIN

Zulassungsgegenstand  
und Verwendungszweck  
*Generic type and use  
of construction product*

Verbunddübel mit Gewindestangen, Betonstahl, Innengewindehülsen  
und Hilti Zuganker HZA zur Verankerung im Beton  
*Bonded anchor with threaded rods, rebar, internal threaded sleeves  
and Hilti tension anchor HZA for use in concrete*

Geltungsdauer:  
*Validity:* vom  
*from*  
bis  
*to*

20 June 2013  
6 February 2017

Herstellwerk  
*Manufacturing plant*

Hilti Werke

Diese Zulassung umfasst  
*This Approval contains*

40 Seiten einschließlich 31 Anhänge  
*40 pages including 31 annexes*

Diese Zulassung ersetzt  
*This Approval replaces*

ETA-12/0084 mit Geltungsdauer vom 08.08.2012 bis 06.02.2017  
*ETA-12/0084 with validity from 08.08.2012 to 06.02.2017*

## I LEGAL BASES AND GENERAL CONDITIONS

- 1 This European technical approval is issued by Deutsches Institut für Bautechnik in accordance with:
  - Council Directive 89/106/EEC of 21 December 1988 on the approximation of laws, regulations and administrative provisions of Member States relating to construction products<sup>1</sup>, modified by Council Directive 93/68/EEC<sup>2</sup> and Regulation (EC) N° 1882/2003 of the European Parliament and of the Council<sup>3</sup>;
  - *Gesetz über das In-Verkehr-Bringen von und den freien Warenverkehr mit Bauprodukten zur Umsetzung der Richtlinie 89/106/EWG des Rates vom 21. Dezember 1988 zur Angleichung der Rechts- und Verwaltungsvorschriften der Mitgliedstaaten über Bauprodukte und anderer Rechtsakte der Europäischen Gemeinschaften (Bauproduktengesetz - BauPG) vom 28. April 1998<sup>4</sup>, as amended by Article 2 of the law of 8 November 2011<sup>5</sup>;*
  - Common Procedural Rules for Requesting, Preparing and the Granting of European technical approvals set out in the Annex to Commission Decision 94/23/EC<sup>6</sup>;
  - Guideline for European technical approval of "Metal anchors for use in concrete - Part 5: Bonded anchors", ETAG 001-05.
- 2 Deutsches Institut für Bautechnik is authorized to check whether the provisions of this European technical approval are met. Checking may take place in the manufacturing plant. Nevertheless, the responsibility for the conformity of the products to the European technical approval and for their fitness for the intended use remains with the holder of the European technical approval.
- 3 This European technical approval is not to be transferred to manufacturers or agents of manufacturers other than those indicated on page 1, or manufacturing plants other than those indicated on page 1 of this European technical approval.
- 4 This European technical approval may be withdrawn by Deutsches Institut für Bautechnik, in particular pursuant to information by the Commission according to Article 5(1) of Council Directive 89/106/EEC.
- 5 Reproduction of this European technical approval including transmission by electronic means shall be in full. However, partial reproduction can be made with the written consent of Deutsches Institut für Bautechnik. In this case partial reproduction has to be designated as such. Texts and drawings of advertising brochures shall not contradict or misuse the European technical approval.
- 6 The European technical approval is issued by the approval body in its official language. This version corresponds fully to the version circulated within EOTA. Translations into other languages have to be designated as such.

<sup>1</sup> Official Journal of the European Communities L 40, 11 February 1989, p. 12  
<sup>2</sup> Official Journal of the European Communities L 220, 30 August 1993, p. 1  
<sup>3</sup> Official Journal of the European Union L 284, 31 October 2003, p. 25  
<sup>4</sup> *Bundesgesetzblatt Teil I 1998*, p. 812  
<sup>5</sup> *Bundesgesetzblatt Teil I 2011*, p. 2178  
<sup>6</sup> Official Journal of the European Communities L 17, 20 January 1994, p. 34



Elements made of stainless steel (threaded rods HIT-V-R, internal sleeve HIS-RN, tension anchor HZA-R):

The element made of stainless steel 1.4401, 1.4404, 1.4578, 1.4571, 1.4439 or 1.4362 may be used in structures subject to dry internal conditions and also in structures subject to external atmospheric exposure (including industrial and marine environment), or exposure to permanently damp internal conditions, if no particular aggressive conditions exist. Such particular aggressive conditions are e.g. permanent, alternating immersion in seawater or the splash zone of seawater, chloride atmosphere of indoor swimming pools or atmosphere with extreme chemical pollution (e.g. in desulphurization plants or road tunnels where de-icing materials are used).

Elements made of high corrosion resistant steel (threaded rods HIT-V-HCR):

The element made of high corrosion resistant steel 1.4529 or 1.4565 may be used in structures subject to dry internal conditions and also in structures subject to external atmospheric exposure, in permanently damp internal conditions or in other particular aggressive conditions. Such particular aggressive conditions are e. g. permanent, alternating immersion in seawater or the splash zone of seawater, chloride atmosphere of indoor swimming pools or atmosphere with chemical pollution (e.g. in desulphurization plants or road tunnels where de-icing materials are used).

Elements made of reinforcing bars:

Post-installed reinforcing bars may be used as anchor designed in accordance with the EOTA Technical Reports TR 029 and TR 045 only. Such applications are e.g. concrete overlay or shear dowel connections or the connections of a wall predominantly loaded by shear and compression forces with the foundation, where the reinforcing bars act as dowels to take up shear forces. Connections with post-installed reinforcing bars in concrete structures designed in accordance with EN 1992-1-1:2004 are not covered by this European technical approval.

The provisions made in this European technical approval are based on an assumed working life of the anchor of 50 years. The indications given on the working life cannot be interpreted as a guarantee given by the producer, but are to be regarded only as a means for choosing the right products in relation to the expected economically reasonable working life of the works.

## 2 Characteristics of the product and methods of verification

### 2.1 Characteristics of the product

The anchor corresponds to the drawings and provisions given in the Annexes. The characteristic material values, dimensions and tolerances of the anchor not indicated in the Annexes shall correspond to the respective values laid down in the technical documentation<sup>7</sup> of this European technical approval.

The characteristic values for the design of anchorages are given in the Annexes.

The two components of the injection mortar Hilti HIT-HY 200-R are delivered in unmixed condition in foil packs of sizes 330 ml or 500 ml according to Annex 1. Each foil pack is marked with the identifying mark "HY 200-R", with the batch number and expiry date.

<sup>7</sup>

The technical documentation of this European technical approval is deposited at the Deutsches Institut für Bautechnik and, as far as relevant for the tasks of the approved bodies involved in the attestation of conformity procedure, is handed over to the approved bodies.

Each threaded rod HIT-V is marked with the marking of steel grade and length in accordance with Annex 3. Each threaded rod made of stainless steel is marked with the additional letter "R". Each threaded rod made of high corrosion resistant steel is marked with the additional letter "HCR".

Each internal sleeve made of zinc coated steel is marked with "Hilti HIS-N" according to Annex 4. Each internal sleeve made of stainless steel is marked with "Hilti HIS-RN" according to Annex 4.

Each Tension anchor made of stainless steel is marked with "HZA-R", the thread size and maximum thickness of fixture according to Annex 6.

Elements made of reinforcing bar shall comply with the specifications given in Annex 5.

The marking of embedment depth may be done on jobsite.

## 2.2 Methods of verification

The assessment of fitness of the anchor for the intended use in relation to the requirements for mechanical resistance and stability and safety in use in the sense of the Essential Requirements 1 and 4 has been made in accordance with the "Guideline for European technical approval of Metal Anchors for use in concrete", Part 1 "Anchors in general" and Part 5 "Bonded anchors", on the basis of Option 1 and ETAG 001 Annex E "Assessment of Metal Anchors under Seismic Action".

In addition to the specific clauses relating to dangerous substances contained in this European technical approval, there may be other requirements applicable to the products falling within its scope (e.g. transposed European legislation and national laws, regulations and administrative provisions). In order to meet the provisions of the Construction Products Directive, these requirements need also to be complied with, when and where they apply.

## 3 Evaluation and attestation of conformity and CE marking

### 3.1 System of attestation of conformity

According to the Decision 96/582/EG of the European Commission<sup>8</sup> system 2(i) (referred to as System 1) of the attestation of conformity applies.

This system of attestation of conformity is defined as follows:

System 1: Certification of the conformity of the product by an approved certification body on the basis of:

- (a) Tasks for the manufacturer:
  - (1) factory production control;
  - (2) further testing of samples taken at the factory by the manufacturer in accordance with a control plan;
- (b) Tasks for the approved body:
  - (3) initial type-testing of the product;
  - (4) initial inspection of factory and of factory production control;
  - (5) continuous surveillance, assessment and approval of factory production control.

Note: Approved bodies are also referred to as "notified bodies".

<sup>8</sup> Official Journal of the European Communities L 254 of 08.10.1996

### 3.2 Responsibilities

#### 3.2.1 Tasks for the manufacturer

##### 3.2.1.1 Factory production control

The manufacturer shall exercise permanent internal control of production. All the elements, requirements and provisions adopted by the manufacturer shall be documented in a systematic manner in the form of written policies and procedures, including records of results performed. This production control system shall insure that the product is in conformity with this European technical approval.

The manufacturer may only use initial/raw/constituent materials stated in the technical documentation of this European technical approval.

The factory production control shall be in accordance with the control plan which is part of the technical documentation of this European technical approval. The control plan is laid down in the context of the factory production control system operated by the manufacturer and deposited at Deutsches Institut für Bautechnik.<sup>9</sup>

The results of factory production control shall be recorded and evaluated in accordance with the provisions of the control plan.

##### 3.2.1.2 Other tasks for the manufacturer

The manufacturer shall, on the basis of a contract, involve a body which is approved for the tasks referred to in section 3.1 in the field of anchors in order to undertake the actions laid down in section 3.2.2 For this purpose, the control plan referred to in sections 3.2.1.1 and 3.2.2 shall be handed over by the manufacturer to the approved body involved.

The manufacturer shall make a declaration of conformity, stating that the construction product is in conformity with the provisions of this European technical approval.

#### 3.2.2 Tasks for the approved bodies

The approved body shall perform the

- initial type-testing of the product,
- initial inspection of factory and of factory production control,
- continuous surveillance, assessment and approval of factory production control,

in accordance with the provisions laid down in the control plan.

The approved body shall retain the essential points of its actions referred to above and state the results obtained and conclusions drawn in a written report.

The approved certification body involved by the manufacturer shall issue an EC certificate of conformity of the product stating the conformity with the provisions of this European technical approval.

In cases where the provisions of the European technical approval and its control plan are no longer fulfilled the certification body shall withdraw the certificate of conformity and inform Deutsches Institut für Bautechnik without delay.

<sup>9</sup> The control plan is a confidential part of the European technical approval and only handed over to the approved body involved in the procedure of attestation of conformity. See section 3.2.2.

### 3.3 CE marking

The CE marking shall be affixed on each packaging of the anchor. The letters "CE" shall be followed by the identification number of the approved certification body, where relevant, and be accompanied by the following additional information:

- the name and address of the producer (legal entity responsible for the manufacture),
- the last two digits of the year in which the CE marking was affixed,
- the number of the EC certificate of conformity for the product,
- the number of the European technical approval,
- the number of the guideline for European technical approval,
- use category (ETAG 001-1, Option 1, in addition: seismic performance category C1 - where applicable),
- size.

## 4 Assumptions under which the fitness of the product for the intended use was favourably assessed

### 4.1 Manufacturing

The European technical approval is issued for the product on the basis of agreed data/information, deposited at Deutsches Institut für Bautechnik, which identifies the product that has been assessed and judged. Changes to the product or production process, which could result in this deposited data/information being incorrect, should be notified to Deutsches Institut für Bautechnik before the changes are introduced. Deutsches Institut für Bautechnik will decide whether or not such changes affect the approval and consequently the validity of the CE marking on the basis of the approval and if so whether further assessment or alterations to the approval shall be necessary.

### 4.2 Design of anchorages

The fitness of the anchor for the intended use is given under the following conditions:

The anchorages are designed in accordance with the EOTA Technical Report TR 029 "Design of bonded anchors"<sup>10</sup> and EOTA Technical Report TR 045 "Design of Metal Anchors under Seismic Action" under the responsibility of an engineer experienced in anchorages and concrete work.

Anchorage shall be positioned outside of critical regions (e.g. plastic hinges) of the concrete structure. Fastenings in stand-off installation or with a grout layer under seismic action are not covered by this European technical approval.

Post-installed reinforcing bars may be used as anchor designed in accordance with the EOTA Technical Reports TR 029 and TR 045 only. The basic assumptions for the design according to anchor theory shall be observed. This includes the consideration of tension and shear loads and the corresponding failure modes as well as the assumption that the base material (concrete structural element) remains essentially in the serviceability limit state (either non-cracked or cracked) when the connection is loaded to failure. Such applications are e.g. concrete overlay or shear dowel connections or the connections of a wall predominantly loaded by shear and compression forces with the foundation, where the reinforcing bars act as dowels to take up shear forces. Connections with reinforcing bars in concrete structures designed in accordance with EN1992-1-1:2004 (e.g. connection of a wall loaded with tension forces in one layer of the reinforcement with the foundation) are not covered by this European technical approval.

Material and required strength class of the fastening screws or threaded rods shall be specified in accordance with Annex 7.

<sup>10</sup> The Technical Report TR 029 "Design of bonded anchors" is published in English on EOTA website [www.eota.eu](http://www.eota.eu).



The minimum and maximum thread engagement length  $h_s$  of the fastening screw or the threaded rod for installation of the fixture shall meet the requirements according to Annex 4, Table 3. The length of the fastening screw or the threaded rod shall be determined depending on thickness of fixture, admissible tolerances, available thread length and minimum and maximum thread engagement length  $h_s$ .

Verifiable calculation notes and drawings are prepared taking account of the loads to be anchored.

The position of the anchor is indicated on the design drawings (e.g. position of the anchor relative to reinforcement or to supports, etc.).

### 4.3 Installation of anchors

The fitness for use of the anchor can only be assumed if the anchor is installed as follows:

- anchor installation carried out by appropriately qualified personnel and under the supervision of the person responsible for technical matters of the site,
- anchor installation in accordance with the manufacturer's specifications and drawings using the tools indicated in the technical documentation of this European technical approval,
- use of the anchor only as supplied by the manufacturer without exchanging the components of an anchor,
- commercial standard threaded rods, washers and hexagon nuts may also be used if the following requirements are fulfilled:
  - material, dimensions and mechanical properties of the metal parts according to the specifications given in Annex 7, Table 7,
  - confirmation of material and mechanical properties of the metal parts by inspection certificate 3.1 according to EN 10204:2004, the documents should be stored,
  - marking of the threaded rod with the envisage embedment depth. This may be done by the manufacturer of the rod or the person on jobsite.
- embedded reinforcing bars shall comply with specifications given in Annex 5,
- checks before placing the anchor to ensure that the strength class of the concrete in which the anchor is to be placed is in the range given and is not lower than that of the concrete to which the characteristic loads apply,
- check of concrete being well compacted, e.g. without significant voids,
- marking and keeping the effective anchorage depth,
- edge distance and spacing not less than the specified values without minus tolerances,
- positioning of the drill holes without damaging the reinforcement,
- drilling by hammer-drilling or Hilti hollow drill bit TE-CD/TE-YD,
- in case of aborted drill hole: the drill hole shall be filled with mortar,
- the anchor must not be installed in flooded holes,
- keeping the installation instructions given in Annexes 8 to 10,
- for injection of the mortar in depths of bore hole  $h_0 \geq 250$  mm piston plugs shall be used,
- the installation temperature of the mortar shall be at least 0 °C; during curing of the chemical mortar the temperature of the concrete must not fall below -10 °C; observing the curing time according to Annex 10, Table 8 until the anchor may be loaded,
- fastening screws or threaded rods (including nut and washer) for the internal sleeves HIS-(R)N must be made of appropriate steel grade and property class,
- installation torque moments are not required for functioning of the anchor. However, the torque moments given in Annexes 3, 4 and 6 must not be exceeded.



## 5 Recommendations concerning packaging, transport and storage

### 5.1 Responsibility of the manufacturer

The manufacturer is responsible to ensure that the information on the specific conditions according to 1 and 2 including Annexes referred to as well as sections 4.2 and 4.3 is given to those who are concerned. This information may be made by reproduction of the respective parts of the European technical approval.

In addition all installation data shall be shown clearly on the package and/or on an enclosed instruction sheet, preferably using illustration(s).

The minimum data required are:

- drill bit diameter,
- hole depth,
- diameter of anchor rod,
- minimum effective anchorage depth,
- information on the installation procedure, including cleaning of the hole with the cleaning equipments, preferably by means of an illustration,
- anchor component installation temperature,
- ambient temperature of the concrete during installation of the anchor,
- admissible processing time (open time) of the mortar,
- curing time until the anchor may be loaded as a function of the ambient temperature in the concrete during installation,
- maximum torque moment,
- identification of the manufacturing batch,

All data shall be presented in a clear and explicit form.

### 5.2 Packaging, transport and storage

The foil packs shall be protected against sun radiation and shall be stored according to the manufacturer's installation instructions in dry condition at temperatures of at least +5 °C to not more than +25 °C.

Foil packs with expired shelf life must no longer be used.

The anchor shall only be packaged and supplied as a complete unit. Foil packs may be packed separately from metal parts.

Andreas Kummerow  
p. p. Head of Department

*beglaubigt:*  
Lange

**Injection mortar Hilti HIT-HY 200-R:**

hybrid system with resin, hardener and cement water component

**Foil pack 330 ml and 500 ml**

Marking  
HY 200-R  
Batch number  
Expiry date



**Static Mixer HILTI HIT-RE-M**

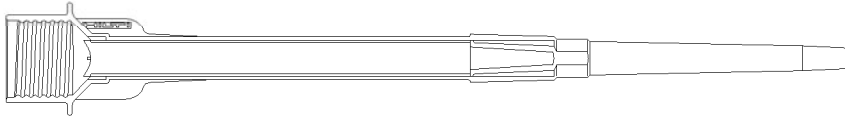

**Steel elements:**

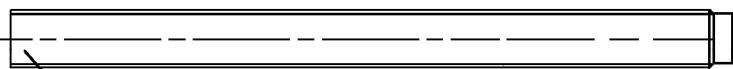

**Threaded rod HIT-V-...**  
thread sizes M8, M10, M12, M16, M20, M24, M27 or M30

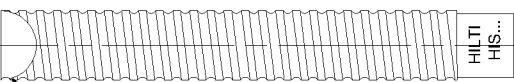
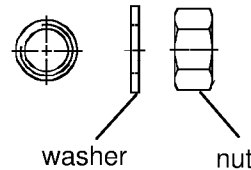

**Internal sleeve HIS-(R)N...**  
thread sizes M8, M10, M12, M16 or M20



**Deformed carbon steel bars for concrete reinforcement (rebar)**  
Ø8, Ø10, Ø12, Ø14, Ø16, Ø20, Ø25, Ø26, Ø28, Ø30 or Ø32

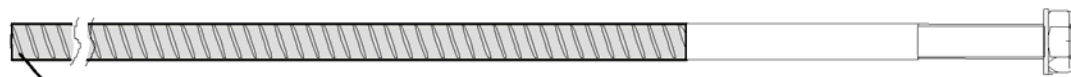

**Hilti Tension anchor HZA-R** M12, M16, M20 or M24  
**Hilti Tension anchor HZA** M12, M16, M20, M24 or M27

**Injection system Hilti HIT-HY 200-R**

**Annex 1**

**Product**

### Installed anchor

#### Threaded rod HIT-V ...

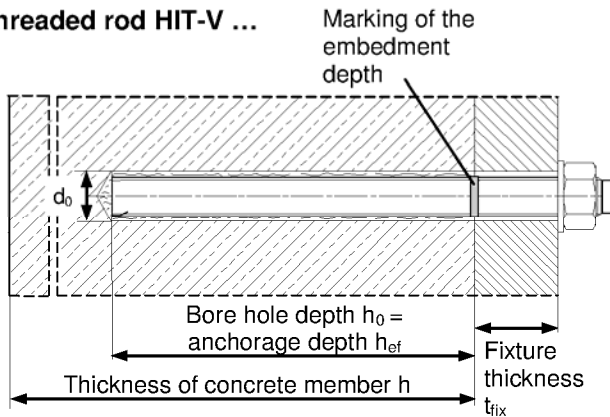



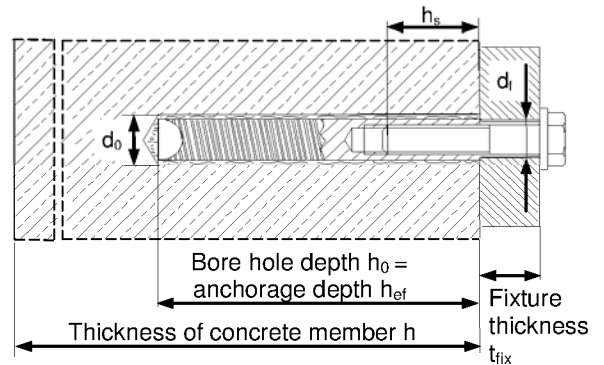

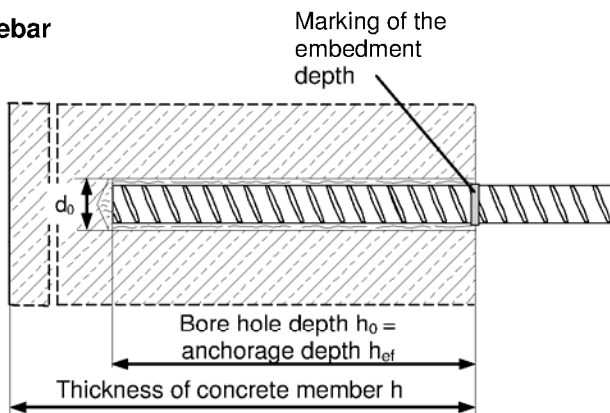

#### Internal sleeve HIS-(R)N



#### rebar



**Table 1: Overview use category and performance category**

	Drilling method		HIT-HY 200-R with ...			
	Hilti hollow drill bit 	Hammer drilling 	HIT-V ... 	Rebar 	HIS-(R)N 	HZA (-R) 
Static and quasi static loading, in cracked and non-cracked concrete	✓	✓	Annex 12, 13, 14	Annex 15, 16, 17	Annex 18, 19, 20	Annex 21, 22, 23
Seismic performance category C1	✓	✓	Annex 24, 25	Annex 26, 27	-	Annex 28, 29
Use category: dry or wet concrete	✓	✓	✓	✓	✓	✓
Installation temperature	-10 °C to +40 °C					
In-service temperature	Temperature range I:	-40 °C to +40 °C	(max. long term temperature +24 °C and max. short term temperature +40 °C)			
	Temperature range II:	-40 °C to +80 °C	(max. long term temperature +50 °C and max. short term temperature +80 °C)			
	Temperature range III:	-40 °C to +120 °C	(max. long term temperature +72 °C and max. short term temperature +120 °C)			

**Injection system Hilti HIT-HY 200-R**

**Annex 2**

**Intended use and use category**

**Table 2: Installation data: threaded rod HIT-V-...**

Hilti HIT-HY 200-R with HIT-V-...		M8	M10	M12	M16	M20	M24	M27	M30
Diameter of element	d [mm]	8	10	12	16	20	24	27	30
Range of anchorage ( $h_{ef}$ ) and drill hole depth ( $h_0$ )	min [mm]	60	60	70	80	90	96	108	120
	max [mm]	160	200	240	320	400	480	540	600
Nominal diameter of drill bit	$d_0$ [mm]	10	12	14	18	22	28	30	35
Diameter of clearance hole in the fixture <sup>1)</sup>	$d_f \leq$ [mm]	9	12	14	18	22	26	30	33
Maximum torque moment	$T_{max}$ [Nm]	10	20	40	80	150	200	270	300
Minimum thickness of concrete member	$h_{min}$ [mm]	$h_{ef} + 30$			$h_{ef} + 2d_0$				
Minimum spacing	$s_{min}$ [mm]	40	50	60	80	100	120	135	150
Minimum edge distance	$c_{min}$ [mm]	40	50	60	80	100	120	135	150

<sup>1)</sup> for larger clearance hole in the fixture see TR 029 section 1.1.

**HIT-V...**

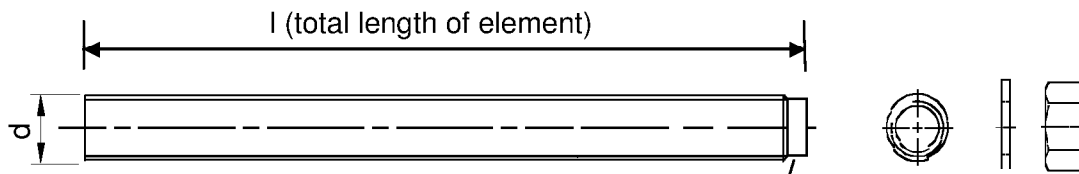

**Head marking:**  
 5.8 - l = HIT-V-5.8 - l  
 5.8F - l = HIT-V-5.8F - l  
 8.8 - l = HIT-V-8.8 - l  
 8.8F - l = HIT-V-8.8F - l  
 R - l = HIT-V-R - l  
 HCR - l = HIT-V-HCR - l

**Injection system Hilti HIT-HY 200-R**

**Annex 3**

**Installation data  
Threaded rod HIT-V-...**

**Table 3: Installation data: internal sleeve HIS-(R)N**

Hilti HIT-HY 200-R with HIS-(R)N			M8	M10	M12	M16	M20
Diameter of element	d	[mm]	12,5	16,5	20,5	25,4	27,6
Effective anchorage depth	$h_{ef}$	[mm]	90	110	125	170	205
Nominal diameter of drill bit	$d_0$	[mm]	14	18	22	28	32
Depth of drilled hole	$h_0$	[mm]	90	110	125	170	205
Diameter of clearance hole in the fixture	$d_f \leq$	[mm]	9	12	14	18	22
Maximum torque moment	$T_{max}$	[Nm]	10	20	40	80	150
Thread engagement length min-max	$h_s$	[mm]	8-20	10-25	12-30	16-40	20-50
Minimum thickness of concrete member	$h_{min}$	[mm]	120	150	170	230	270
Minimum spacing	$s_{min}$	[mm]	40	45	55	65	90
Minimum edge distance	$c_{min}$	[mm]	40	45	55	65	90

**HIS-(R)N**

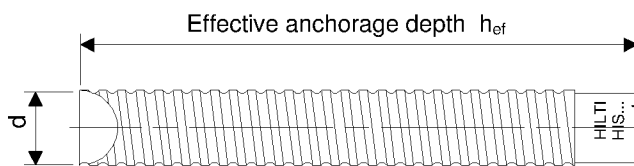

**Marking:**  
Identifying mark - HILTI and  
embossing "HIS-N" (for C-steel)  
embossing "HIS-RN" (for stainless steel)

**Injection system Hilti HIT-HY 200-R**

**Annex 4**

**Installation data  
Internal sleeve HIS-(R)N**

**Table 4: Installation data: anchor element rebar**

Hilti HIT-HY 200-R with Rebar ...	Ø8	Ø10	Ø12	Ø14	Ø16	Ø20	Ø25	Ø26	Ø28	Ø30	Ø32	
Diameter of element d [mm]	8	10	12	14	16	20	25	26	28	30	32	
Range of effective anchorage depth $h_{ef}$ and depth of drilled hole $h_0$	min [mm]	60	60	70	75	80	90	100	104	112	120	128
	max [mm]	160	200	240	280	320	400	500	520	560	600	640
Nominal diameter of drill bit $d_0$ [mm]	12 / 10 <sup>1)</sup>	14 / 12 <sup>1)</sup>	14 <sup>1)</sup>	16 <sup>1)</sup>	18	20	25	32	32	35	37	40
Minimum thickness of concrete member $h_{min}$ [mm]	$h_{ef} + 30$			$h_{ef} + 2d_0$								
Minimum spacing $s_{min}$ [mm]	40	50	60	70	80	100	125	130	140	150	160	
Minimum edge distance $c_{min}$ [mm]	40	50	60	70	80	100	125	130	140	150	160	

<sup>1)</sup> Each of the two given values can be used.

### Rebar



Refer to EN1992-1-1 Annex C Table C.1 and C.2N Properties of reinforcement:

Product form	Bars and de-coiled rods	
Class	B	C
Characteristic yield strength $f_{yk}$ or $f_{0,2k}$ (MPa)	400 to 600	
Minimum value of $k = (f_t/f_y)_k$	$\geq 1,08$	$\geq 1,15$ $< 1,35$
Characteristic strain at maximum force, $\varepsilon_{uk}$ (%)	$\geq 5,0$	$\geq 7,5$
Bendability	Bend / Rebind test	
Maximum deviation from nominal mass (individual bar) (%)	Nominal bar size (mm)	
	$\leq 8$	$\pm 6,0$
	$> 8$	$\pm 4,5$
Bond:	Nominal bar size (mm)	
Minimum relative rib area, $f_{R,min}$ (determination according to EN 15630)	8 to 12	0,040
	$> 12$	0,056

### Height of the rebar rib $h_{rib}$ :

The height of the rebar rib  $h_{rib}$  shall fulfil the following requirement:  $0,05 * d \leq h_{rib} \leq 0,07 * d$  with:  $d$  = nominal diameter of the rebar element.

Injection system Hilti HIT-HY 200-R

Annex 5

Installation data  
Anchor element rebar

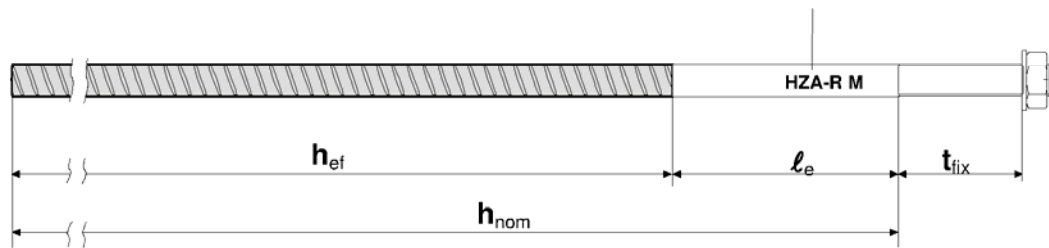

**Table 5: Installation data: Hilti tension anchor HZA-R**

Hilti HIT-HY 200-R with HZA-R ...		M12	M16	M20	M24
Diameter of the reinforcement bar	d [mm]	12	16	20	25
Range of embedment depth $h_{nom}$ and depth of drilled hole $h_0$	min [mm]	170	180	190	200
	max [mm]	240	320	400	500
Bond length	$h_{ef}$ [mm]	$h_{nom} - 100$			
Length of smooth shaft	$l_e$ [mm]	100			
Nominal diameter of drill bit	$d_0$ [mm]	16	20	25	32
Diameter of clearance hole in the fixture	$d_f \leq$ [mm]	14	18	22	26
Max. torque moment	$T_{max}$ [Nm]	40	80	150	200
Minimum thickness of concrete member	$h_{min}$ [mm]	$h_{nom} + 2 \times d_0$			
Minimum spacing	$s_{min}$ [mm]	60	80	100	120
Minimum edge distance	$c_{min}$ [mm]	60	80	100	120

**HZA-R**

Marking: "HZA-R" M .. /  $t_{fix}$



**Table 6: Installation data: Hilti tension anchor HZA**

Hilti HIT-HY 200-R with HZA ...		M12	M16	M20	M24	M27
Diameter of the reinforcement bar	d [mm]	12	16	20	25	28
Range of embedment depth $h_{nom}$ and depth of drilled hole $h_0$	min [mm]	90	100	110	120	140
	max [mm]	240	320	400	500	560
Bond length	$h_{ef}$ [mm]	$h_{nom} - 20$				
Length of smooth shaft	$l_e$ [mm]	20				
Nominal diameter of drill bit	$d_0$ [mm]	16	20	25	32	35
Diameter of clearance hole in the fixture	$d_f \leq$ [mm]	14	18	22	26	30
Max. torque moment	$T_{max}$ [Nm]	40	80	150	200	270
Minimum thickness of concrete member	$h_{min}$ [mm]	$h_{nom} + 2 \times d_0$				
Minimum spacing	$s_{min}$ [mm]	60	80	100	120	135
Minimum edge distance	$c_{min}$ [mm]	60	80	100	120	135

**Injection system Hilti HIT-HY 200-R**

**Annex 6**

**Installation data  
Hilti tension anchor HZA, HZA-R**

**Table 7: Materials**

Designation	Material
<b>Metal parts made of rebar</b>	
Rebar	See Annex 5
<b>Metal parts made of zinc coated steel</b>	
Threaded rod HIT-V-5.8(F)	Strength class 5.8 , $R_m = 500 \text{ N/mm}^2$ ; $R_{p0,2} = 400 \text{ N/mm}^2$ , $A_5 > 8\%$ Ductile Steel galvanized $\geq 5\mu\text{m}$ EN ISO 4042 (F) hot dipped galvanized $\geq 45\mu\text{m}$ EN ISO 10684
Threaded rod HIT-V-8.8(F)	Strength class 8.8 , $R_m = 800 \text{ N/mm}^2$ ; $R_{p0,2} = 640 \text{ N/mm}^2$ , $A_5 > 8\%$ Ductile Steel galvanized $\geq 5\mu\text{m}$ EN ISO 4042 (F) hot dipped galvanized $\geq 45\mu\text{m}$ EN ISO 10684
Hilti tension anchor HZA	Round steel smooth with thread, steel galvanized A2K EN ISO 4042 Rebar B500B acc. DIN 488-1:2009 and DIN 488-2:2009
Washer ISO 7089	Steel galvanized EN ISO 4042; hot dipped galvanized EN ISO 10684
Nut EN ISO 4032	Strength class 8 ISO 898-2 Steel galvanized $\geq 5\mu\text{m}$ EN ISO 4042; hot dipped galvanized $\geq 45\mu\text{m}$ EN ISO 10684
Internally threaded Sleeves <sup>1)</sup> HIS-N	Carbon steel 1.0718, EN 10277-3 Steel galvanized $\geq 5\mu\text{m}$ EN ISO 4042
<b>Metal parts made of stainless steel</b>	
Threaded rod HIT-V-R	For $\leq M24$ : strength class 70 , $R_m = 700 \text{ N/mm}^2$ ; $R_{p0,2} = 450 \text{ N/mm}^2$ ; $A_5 > 8\%$ Ductile For $> M24$ : strength class 50 , $R_m = 500 \text{ N/mm}^2$ ; $R_{p0,2} = 210 \text{ N/mm}^2$ ; $A_5 > 8\%$ Ductile Stainless steel 1.4401; 1.4404; 1.4578; 1.4571; 1.4439; 1.4362 EN 10088
Washer ISO 7089	Stainless steel 1.4401; 1.4404; 1.4578; 1.4571; 1.4439; 1.4362 EN 10088
Nut EN ISO 4032	Strength class 70 EN ISO 3506-2 Stainless steel 1.4401; 1.4404; 1.4578; 1.4571; 1.4439; 1.4362 EN 10088
Internally threaded sleeves <sup>2)</sup> HIS-RN	Stainless steel 1.4401 and 1.4571 EN 10088
Hilti tension anchor HZA-R	Round steel smooth with thread: Stainless steel 1.4404, 1.4362 and 1.4571 EN 10088 Rebar B500B acc. DIN 488-1:2009 and DIN 488-2:2009
Washer ISO 7089	Stainless steel 1.4401; 1.4404; 1.4578; 1.4439; 1.4362 and 1.4571 EN 10088
Nut EN ISO 4032	Strength class 70 EN ISO 3506-2 Stainless steel 1.4401; 1.4404; 1.4578; 1.4439; 1.4362 and 1.4571 EN 10088
<b>Metal parts made of high corrosion resistant steel</b>	
Threaded rod HIT-V-HCR	For $\leq M20$ : $R_m = 800 \text{ N/mm}^2$ ; $R_{p0,2} = 640 \text{ N/mm}^2$ , $A_5 > 8\%$ Ductile For $> M20$ : $R_m = 700 \text{ N/mm}^2$ ; $R_{p0,2} = 400 \text{ N/mm}^2$ , $A_5 > 8\%$ Ductile High corrosion resistant steel 1.4529, 1.4565 EN 10088
Washer ISO 7089	High corrosion resistant steel 1.4529, 1.4565 EN 10088
Nut EN ISO 4032	Strength class 70 EN ISO 3506-2 High corrosion resistant steel 1.4529, 1.4565 EN 10088

- <sup>1)</sup> related fastening screw: strength class 8.8 EN ISO 898-1,  $A_5 > 8\%$  Ductile, steel galvanized  $\geq 5\mu\text{m}$  EN ISO 4042  
<sup>2)</sup> related fastening screw: strength class 70 EN ISO 3506-1,  $A_5 > 8\%$  Ductile, stainless steel 1.4401; 1.4404; 1.4578; 1.4571; 1.4439; 1.4362 EN 10088

**Injection system Hilti HIT-HY 200-R**

**Annex 7**

**Materials**

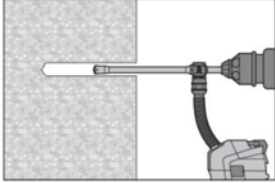
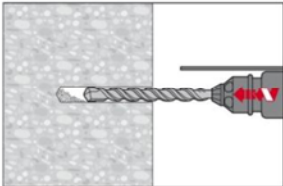
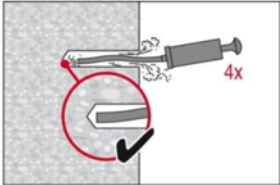
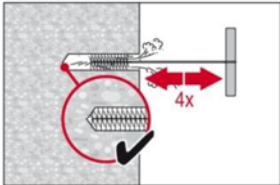
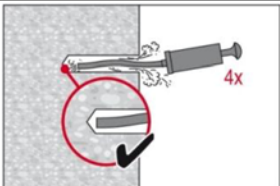
<b>Instruction for use</b>	
<b>Bore hole drilling</b>	
<b>a) Hilti Hollow drill bit</b>	
	Drill hole to the required embedment depth with an appropriately sized Hilti TE-CD or TE-YD hollow drill bit with Hilti vacuum attachment. This drilling system removes the dust and cleans the bore hole during drilling when used in accordance with the user's manual. After drilling is complete, proceed to the "injection preparation" step in the instructions for use.
<b>b) Hammer drilling</b>	
	Drill hole to the required embedment depth with a hammer drill set in rotation-hammer mode using an appropriately sized carbide drill bit.
<b>Bore hole cleaning</b> Just before setting an anchor, the bore hole must be free of dust and debris.	
<b>a) Manual Cleaning (MC) non-cracked concrete only</b> for bore hole diameters $d_0 \leq 20\text{mm}$ and bore hole depth $h_0 \leq 10d$	
	The Hilti manual pump may be used for blowing out bore holes up to diameters $d_0 \leq 20\text{ mm}$ and embedment depths up to $h_{ef} \leq 10d$ .  Blow out at least 4 times from the back of the bore hole until return air stream is free of noticeable dust
	Brush 4 times with the specified brush size (brush $\varnothing \geq$ bore hole $\varnothing$ , see Table 9) by inserting the steel brush Hilti HIT-RB to the back of the hole (if needed with extension) in a twisting motion and removing it. The brush must produce natural resistance as it enters the bore hole -- if not the brush is too small and must be replaced with the proper brush diameter.
	Blow out again with manual pump at least 4 times until return air stream is free of noticeable dust.
<b>Injection system Hilti HIT-HY 200-R</b>	
<b>Instruction for use I</b>	
<b>Annex 8</b>	

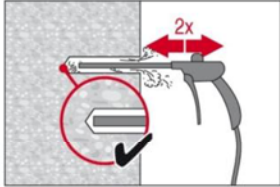
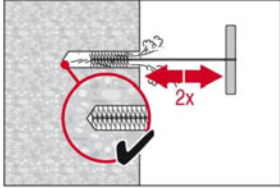
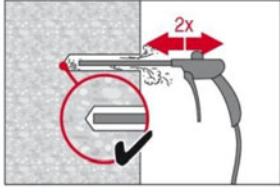
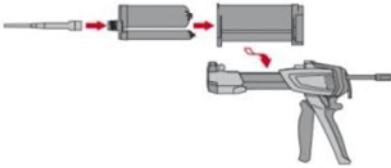
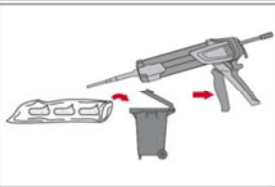
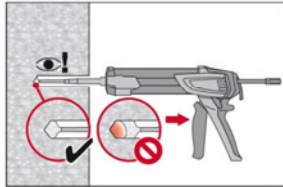
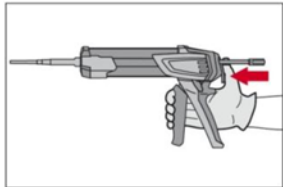
<b>Bore hole cleaning</b> Just before setting an anchor, the bore hole must be free of dust and debris.							
<b>b) Compressed air cleaning (CAC)</b> for all bore hole diameters $d_0$ and all bore hole depth $h_0$							
	Blow 2 times from the back of the hole (if needed with nozzle extension) over the hole length with oil-free compressed air (min. 6 bar at 6 m³/h) until return air stream is free of noticeable dust. Bore hole diameter $\geq 32$ mm the compressor must supply a minimum air flow of 140 m³/hour.						
	Brush 2 times with the specified brush size (brush $\varnothing \geq$ bore hole $\varnothing$ , see Table 9) by inserting the steel brush Hilti HIT-RB to the back of the hole (if needed with extension) in a twisting motion and removing it. The brush must produce natural resistance as it enters the bore hole -- if not the brush is too small and must be replaced with the proper brush diameter.						
	Blow again with compressed air 2 times until return air stream is free of noticeable dust.						
<b>Injection preparation</b>							
	Tightly attach new Hilti mixing nozzle HIT-RE-M to foil pack manifold (snug fit). Do not modify the mixing nozzle. Observe the instruction for use of the dispenser. Check foil pack holder for proper function. Do not use damaged foil packs / holders. Insert foil pack into foil pack holder and put holder into HIT-dispenser.						
	The foil pack opens automatically as dispensing is initiated. Discard initial adhesive. Depending on the size of the foil pack an initial amount of adhesive has to be discarded. Discard quantities are <table border="0"> <tr> <td>2 strokes</td> <td>for 330 ml foil pack,</td> </tr> <tr> <td>3 strokes</td> <td>for 500 ml foil pack,</td> </tr> <tr> <td>4 strokes</td> <td>for 500 ml foil pack <math>\leq 5^\circ\text{C}</math>.</td> </tr> </table>	2 strokes	for 330 ml foil pack,	3 strokes	for 500 ml foil pack,	4 strokes	for 500 ml foil pack $\leq 5^\circ\text{C}$ .
2 strokes	for 330 ml foil pack,						
3 strokes	for 500 ml foil pack,						
4 strokes	for 500 ml foil pack $\leq 5^\circ\text{C}$ .						
<b>Inject adhesive</b> from the back of the borehole without forming air voids							
	Inject the adhesive starting at the back of the hole, slowly withdrawing the mixer with each trigger pull. Fill holes approximately 2/3 full, or as required to ensure that the annular gap between the anchor and the concrete is completely filled with adhesive along the embedment length.						
	After injection is completed, depressurize the dispenser by pressing the release trigger. This will prevent further adhesive discharge from the mixer.						
<b>Injection system Hilti HIT-HY 200-R</b>							
<b>Instruction for use II</b>							
<b>Annex 9</b>							

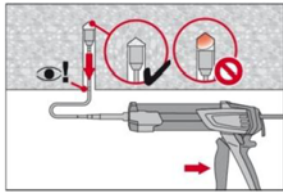

Overhead installation and/or installation with embedment depth  $h_{ef} > 250\text{mm}$ .

For overhead installation the injection is only possible with the aid of extensions and piston plugs. Assemble HIT-RE-M mixer, extension(s) and appropriately sized piston plug HIT-SZ (see Table 9). Insert piston plug to back of the hole and inject adhesive. During injection the piston plug will be naturally extruded out of the bore hole by the adhesive pressure.

### Setting the element

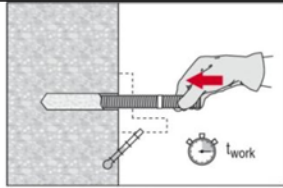

Before use, verify that the element is dry and free of oil and other contaminants.

Mark and set element to the required embedment depth until working time  $t_{work}$  has elapsed. The working time  $t_{work}$  is given in Table 8.

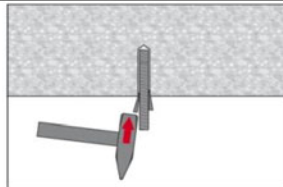

For overhead installation use piston plugs and fix embedded parts with e.g. wedges (Hilti HIT-OHW).

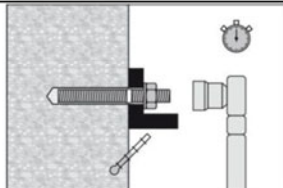

Loading the anchor:

After required curing time  $t_{cure}$  (see Table 8) the anchor can be loaded. The applied installation torque shall not exceed the values  $T_{max}$  given in Tables 2, 3, 5 and 6.

**Table 8: Working time  $t_{work}$  and minimum curing time  $t_{cure}$**

Temperature in the anchorage base	Maximum working time $t_{work}$ Hilti HIT-HY 200-R	Minimum curing time $t_{cure}$ Hilti HIT-HY 200-R
-10 °C to -5 °C	3 hour	20 hour
-4 °C to 0 °C	2 hour	8 hour
1 °C to 5 °C	1 hour	4 hour
6 °C to 10 °C	40 min	2,5 hour
11 °C to 20 °C	15 min	1,5 hour
21 °C to 30 °C	9 min	1 hour
31 °C to 40 °C	6 min	1 hour

Injection system Hilti HIT-HY 200-R

Annex 10

Instruction for use III  
Working time and curing time



**Table 9: Borehole diameter specific installation tools:**

Elements			Drill and clean			Installation
HIT-V ...	HIS-N	Rebar HZA(-R)	Hammer drilling		Brush	Piston plug
			TE-CD TE-YD	TE-C TE-Y		
[mm]	[mm]	[mm]	$d_0$ [mm]	$d_0$ [mm]	HIT-RB	HIT-SZ
8	-	8	-	10	10	-
10	-	8 / 10	12	12	12	12
12	8	10 / 12	14	14	14	14
-	-	12	16	16	16	16
16	10	14	18	18	18	18
-	-	16	20	20	20	20
20	12	-	22	22	22	22
-	-	20	25	25	25	25
24	16	-	28	28	28	28
27	-	-	-	30	30	30
-	20	25 / 26	32	32	32	32
30	-	28	-	35	35	35
-	-	30	-	37	37	37
-	-	32	-	40	40	40

**Automatic cleaning (AC):**

Cleaning is performed during drilling with Hilti TE-CD and TE-YD drilling system including vacuum cleaner.



**Manual Cleaning (MC):**

Hilti hand pump for blowing out bore holes with diameters  $d_0 \leq 20$  mm and bore hole depth  $h_0 \leq 10d$



**Compressed air cleaning (CAC):**

Air nozzle with an orifice opening of minimum 3,5 mm in diameter.



Injection system Hilti HIT-HY 200-R

Annex 11

Bore hole diameter specific installation tools  
Cleaning alternatives



**Table 10: Characteristic tension resistance of threaded rod HIT-V for static and quasi-static loading**

Hilti HIT-HY 200-R with HIT-V-...		M8	M10	M12	M16	M20	M24	M27	M30
<b>Steel failure</b>									
Characteristic resistance HIT-V-5.8(F)	$N_{Rk,s}$ [kN]	18	29	42	79	123	177	230	281
Characteristic resistance HIT-V-8.8(F)	$N_{Rk,s}$ [kN]	29	46	67	126	196	282	367	449
Partial safety factor	$\gamma_{Ms,N}^{1)}$ [-]	1,5							
Characteristic resistance HIT-V-R	$N_{Rk,s}$ [kN]	26	41	59	110	172	247	230	281
Partial safety factor	$\gamma_{Ms,N}^{1)}$ [-]	1,87						2,86	
Characteristic resistance HIT-V-HCR	$N_{Rk,s}$ [kN]	29	46	67	126	196	247	321	393
Partial safety factor	$\gamma_{Ms,N}^{1)}$ [-]	1,5					2,1		
<b>Combined pull-out and Concrete cone failure <sup>3)</sup></b>									
Diameter of threaded rod	$d$ [mm]	8	10	12	16	20	24	27	30
Characteristic bond resistance in non-cracked concrete C20/25									
Temp. range I <sup>4)</sup> : 40°C/24°C	$\tau_{Rk,ucr}$ [N/mm <sup>2</sup> ]	20				15			
Temp. range II <sup>4)</sup> : 80°C/50°C	$\tau_{Rk,ucr}$ [N/mm <sup>2</sup> ]	17				12			
Temp. range III <sup>4)</sup> : 120°C/72°C	$\tau_{Rk,ucr}$ [N/mm <sup>2</sup> ]	14				11			
Characteristic bond resistance in cracked concrete C20/25									
Temp. range I <sup>4)</sup> : 40°C/24°C	$\tau_{Rk,cr}$ [N/mm <sup>2</sup> ]	6	8						
Temp. range II <sup>4)</sup> : 80°C/50°C	$\tau_{Rk,cr}$ [N/mm <sup>2</sup> ]	4,5	6,5						
Temp. range III <sup>4)</sup> : 120°C/72°C	$\tau_{Rk,cr}$ [N/mm <sup>2</sup> ]	4	5,5						
Partial safety factor	$\gamma_{Mp} = \gamma_{Mc} = \gamma_{Msp}^{1)}$ [-]	1,8 <sup>2)</sup>							
Increasing factor for $\tau_{Rk}$ in concrete	$\psi_C$ [-]	1,0							
<b>Splitting failure <sup>3)</sup></b>									
Edge distance $c_{cr,sp}$ [mm] for	$h / h_{ef}^{5)} \geq 2,0$	$1,0 \cdot h_{ef}$							
	$2,0 > h / h_{ef}^{5)} > 1,3$	$4,6 h_{ef} - 1,8 h$							
	$h / h_{ef}^{5)} \leq 1,3$	$2,26 h_{ef}$							
Spacing	$s_{cr,sp}$ [mm]	$2 c_{cr,sp}$							
<ol style="list-style-type: none"> <li>1) In absence of national regulations.</li> <li>2) The partial safety factor <math>\gamma_2 = 1,2</math> is included.</li> <li>3) Calculation of concrete failure and splitting see section 4.2.</li> <li>4) Explanation in section 1.2.</li> <li>5) <math>h</math> = thickness of base material; <math>h_{ef}</math> = anchorage depth.</li> </ol>									
<b>Injection system Hilti HIT-HY 200-R</b>								<b>Annex 12</b>	
<b>Characteristic tension resistance of threaded rod HIT-V for static and quasi-static loading</b>									

**Table 11: Characteristic values for shear load of threaded rod HIT-V  
in case of static and quasi-static loading**

Hilti HIT-HY 200-R with HIT-V-...		M8	M10	M12	M16	M20	M24	M27	M30
<b>Steel failure without lever arm <sup>3)</sup></b>									
Characteristic resistance HIT-V-5.8(F)	$V_{Rk,s}$ [kN]	9	15	21	39	61	88	115	140
Characteristic resistance HIT-V-8.8(F)	$V_{Rk,s}$ [kN]	15	23	34	63	98	141	184	224
Characteristic resistance HIT-V-R	$V_{Rk,s}$ [kN]	13	20	30	55	86	124	115	140
Characteristic resistance HIT-V-HCR	$V_{Rk,s}$ [kN]	15	23	34	63	98	124	161	196
<b>Steel failure with lever arm</b>									
Characteristic resistance HIT-V-5.8(F)	$M_{Rk,s}^0$ [Nm]	19	37	66	167	325	561	832	1125
Characteristic resistance HIT-V-8.8(F)	$M_{Rk,s}^0$ [Nm]	30	60	105	266	519	898	1332	1799
Characteristic resistance HIT-V-R	$M_{Rk,s}^0$ [Nm]	26	52	92	233	454	786	832	1124
Characteristic resistance HIT-V-HCR	$M_{Rk,s}^0$ [Nm]	30	60	105	266	520	786	1165	1574
<b>Partial safety factor steel failure</b>									
HIT-V-5.8(F) or HIT-V-8.8(F)	$\gamma_{Ms,V}^{1)}$ [-]	1,25							
HIT-V-R	$\gamma_{Ms,V}^{1)}$ [-]	1,56						2,38	
HIT-V-HCR	$\gamma_{Ms,V}^{1)}$ [-]	1,25					1,75		
<b>Concrete pry-out failure</b>									
Factor in equation (5.7) of Technical Report TR 029 for the design of bonded anchors	k [-]	2,0							
Partial safety factor	$\gamma_{Mcp}^{1)}$ [-]	1,5 <sup>2)</sup>							
<b>Concrete edge failure</b>									
See section 5.2.3.4 of Technical Report TR 029 for the design of bonded anchors									
Partial safety factor	$\gamma_{Mc}^{1)}$ [-]	1,5 <sup>2)</sup>							

1) In absence of national regulations.

2) The partial safety factor  $\gamma_2 = 1,0$  is included.

3) Acc. to chapter 4.2.2 commercial standard rods that fulfill the ductility requirement  $A_5 > 8\%$  (see table 7) can be used only.

**Injection system Hilti HIT-HY 200-R**

**Annex 13**

**Characteristic shear resistance  
of threaded rod HIT-V for static and quasi-static loading**

**Table 12: Displacements under tension load <sup>1)</sup> of anchor rod HIT-V for static and quasi-static loading**

Hilti HIT-HY 200-R with HIT-V-...			M8	M10	M12	M16	M20	M24	M27	M30
Non-cracked concrete temperature range I <sup>2)</sup> : 40°C / 24°C										
Displacement	$\delta_{N0}$	[mm/(N/mm <sup>2</sup> )]	0,02	0,03	0,03	0,04	0,06	0,07	0,07	0,08
	$\delta_{N\infty}$	[mm/(N/mm <sup>2</sup> )]	0,04	0,05	0,06	0,08	0,10	0,13	0,14	0,16
Non-cracked concrete temperature range II <sup>2)</sup> : 80°C / 50°C										
Displacement	$\delta_{N0}$	[mm/(N/mm <sup>2</sup> )]	0,03	0,04	0,05	0,06	0,08	0,09	0,10	0,12
	$\delta_{N\infty}$	[mm/(N/mm <sup>2</sup> )]	0,04	0,05	0,06	0,09	0,11	0,13	0,15	0,16
Non-cracked concrete temperature range III <sup>2)</sup> : 120°C / 72°C										
Displacement	$\delta_{N0}$	[mm/(N/mm <sup>2</sup> )]	0,04	0,05	0,06	0,08	0,10	0,12	0,13	0,16
	$\delta_{N\infty}$	[mm/(N/mm <sup>2</sup> )]	0,04	0,05	0,07	0,09	0,11	0,13	0,15	0,17
Cracked concrete temperature range I <sup>2)</sup> : 40°C / 24°C										
Displacement	$\delta_{N0}$	[mm/(N/mm <sup>2</sup> )]	0,07							
	$\delta_{N\infty}$	[mm/(N/mm <sup>2</sup> )]	0,16							
Cracked concrete temperature range II <sup>2)</sup> : 80°C / 50°C										
Displacement	$\delta_{N0}$	[mm/(N/mm <sup>2</sup> )]	0,10							
	$\delta_{N\infty}$	[mm/(N/mm <sup>2</sup> )]	0,22							
Cracked concrete temperature range III <sup>2)</sup> : 120°C / 72°C										
Displacement	$\delta_{N0}$	[mm/(N/mm <sup>2</sup> )]	0,13							
	$\delta_{N\infty}$	[mm/(N/mm <sup>2</sup> )]	0,29							

<sup>1)</sup> Calculation of displacement under service load:  $\tau_{sd}$  design value of bond stress  
Displacement under short term loading =  $\delta_{N0} \times \tau_{sd}/1,4$ ;  
Displacement under long term loading =  $\delta_{N\infty} \times \tau_{sd}/1,4$ .

<sup>2)</sup> Explanation see section 1.2.

**Table 13: Displacement under shear load <sup>1)</sup> of anchor rod HIT-V for static and quasi-static loading**

Hilti HIT-HY 200-R with HIT-V-...			M8	M10	M12	M16	M20	M24	M27	M30
Displacement	$\delta_{V0}$	[mm/kN]	0,06	0,06	0,05	0,04	0,04	0,03	0,03	0,03
	$\delta_{V\infty}$	[mm/kN]	0,09	0,08	0,08	0,06	0,06	0,05	0,05	0,05

<sup>1)</sup> Calculation of displacement under service load:  $V_{sd}$  design value of shear stress  
Displacement under short term loading =  $\delta_{V0} \times V_d/1,4$ ;  
Displacement under long term loading =  $\delta_{V\infty} \times V_d/1,4$ .

**Injection system Hilti HIT-HY 200-R**

**Annex 14**

**Displacements  
for threaded rods HIT- V in case of static and quasi-static loading**

**Table 14: Characteristic tension resistance of rebar  
for static and quasi-static loading**

Hilti HIT-HY 200-R with rebar		Ø8	Ø10	Ø12	Ø14	Ø16	Ø20	Ø25	Ø28	Ø32
<b>Steel failure</b>										
Characteristic resistance for rebar B500B acc. to DIN 488:2009-08 <sup>2)</sup>	$N_{Rk,s}$ [kN]	28	43	62	85	111	173	270	339	442
Partial safety factor <sup>3)</sup>	$\gamma_{Ms,N}$ <sup>1)</sup> [-]	1,4								
<b>Combined pull-out and Concrete cone failure <sup>5)</sup></b>										
Diameter of rebar	d [mm]	8	10	12	14	16	20	25	28	32
Characteristic bond resistance in non-cracked concrete C20/25										
Temp. range I <sup>6)</sup> : 40°C/24°C	$\tau_{Rk,ucr}$ [N/mm <sup>2</sup> ]					12				
Temp. range II <sup>6)</sup> : 80°C/50°C	$\tau_{Rk,ucr}$ [N/mm <sup>2</sup> ]					10				
Temp. range III <sup>6)</sup> : 120°C/72°C	$\tau_{Rk,ucr}$ [N/mm <sup>2</sup> ]					8,5				
Characteristic bond resistance in cracked concrete C20/25										
Temp. range I <sup>6)</sup> : 40°C/24°C	$\tau_{Rk,cr}$ [N/mm <sup>2</sup> ]	-	5				7			
Temp. range II <sup>6)</sup> : 80°C/50°C	$\tau_{Rk,cr}$ [N/mm <sup>2</sup> ]	-	4				5,5			
Temp. range III <sup>6)</sup> : 120°C/72°C	$\tau_{Rk,cr}$ [N/mm <sup>2</sup> ]	-	3,5				5			
Partial safety factor	$\gamma_{Mp} = \gamma_{Mc} = \gamma_{Msp}$ <sup>1)</sup> [-]					1,5 <sup>4)</sup>				
Increasing factor for $\tau_{Rk}$ in concrete	$\psi_c$ [-]					1,0				
<b>Splitting failure relevant for non-cracked concrete <sup>5)</sup></b>										
Edge distance $c_{cr,sp}$ [mm] for	$h / h_{ef} \geq 2,0$					$1,0 \cdot h_{ef}$				
	$2,0 > h / h_{ef} > 1,3$					$4,6 h_{ef} - 1,8 h$				
	$h / h_{ef} \leq 1,3$					$2,26 h_{ef}$				
Spacing	$s_{cr,sp}$ [mm]					$2 c_{cr,sp}$				

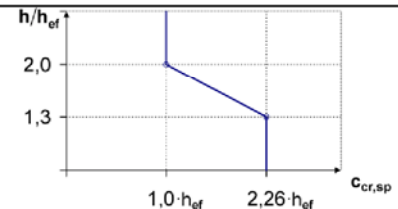

- 1) In absence of national regulations.
- 2) The characteristic tension resistance  $N_{Rk,s}$  for rebars that do not fulfil the requirements acc. DIN 488 shall be calculated acc. Technical Report TR 029, Equation (5.1).
- 3) The partial safety factor  $\gamma_{Ms,N}$  for rebars that do not fulfil the requirements acc. DIN 488 shall be calculated acc. Technical Report TR 029, Equation (3.3a).
- 4) The partial safety factor  $\gamma_2 = 1,0$  is included.
- 5) Calculation of concrete failure and splitting see section 4.2
- 6) Explanation in section 1.2.
- 7)  $h$  = thickness of base material;  $h_{ef}$  = anchorage depth.

**Injection system Hilti HIT-HY 200-R**

**Annex 15**

**Characteristic tension resistance  
of rebar for static and quasi-static loading**

**Table 15: Characteristic shear resistance of rebar  
for static and quasi-static loading**

Hilti HIT-HY 200-R with rebar		Ø8	Ø10	Ø12	Ø14	Ø16	Ø20	Ø25	Ø28	Ø32	
<b>Steel failure without lever arm</b>											
Characteristic resistance for rebar B500B acc. to DIN 488:2009-08 <sup>3)</sup>	$V_{Rk,s}$ [kN]	14	22	31	42	55	86	135	169	221	
<b>Steel failure with lever arm</b>											
Characteristic resistance for rebar B500B acc. to DIN 488:2009-08 <sup>4)</sup>	$M^0_{Rk,s}$ [Nm]	33	65	112	178	265	518	1012	1422	2123	
<b>Partial safety factor steel failure</b>											
Partial safety factor rebar <sup>5)</sup>	$\gamma_{Ms,V}$ <sup>1)</sup> [-]						1,5				
<b>Concrete pry-out failure</b>											
Factor in equation (5.7) of Technical Report TR 029 for the design of bonded anchors	k [-]						2,0				
Partial safety factor	$\gamma_{Mcp}$ <sup>1)</sup> [-]						1,5 <sup>2)</sup>				
<b>Concrete edge failure</b>											
See section 5.2.3.4 of Technical Report TR 029 for the design of bonded anchors											
Partial safety factor	$\gamma_{Mc}$ <sup>1)</sup> [-]						1,5 <sup>2)</sup>				

<sup>1)</sup> In absence of national regulations.

<sup>2)</sup> The partial safety factor  $\gamma_2 = 1,0$  is included.

<sup>3)</sup> The characteristic shear resistance  $V_{Rk,s}$  for rebars that do not fulfil the requirements acc. DIN 488 shall be calculated acc. Technical Report TR 029, Equation (5.5).

<sup>4)</sup> The characteristic bending resistance  $M^0_{Rk,s}$  for rebars that do not fulfil the requirements acc. DIN 488 shall be calculated acc. Technical Report TR 029, Equation (5.6b).

<sup>5)</sup> The partial safety factor  $\gamma_{Ms,V}$  for rebars that do not fulfil the requirements acc. DIN 488 shall be calculated acc. Technical Report TR 029, Equation (3.3b) or (3.3c).

**Injection system Hilti HIT-HY 200-R**

**Annex 16**

**Characteristic shear resistance  
of rebar for static and quasi-static loading**

**Table 16: Displacements under tension load <sup>1)</sup> of rebar for static and quasi-static loading**

Hilti HIT-HY 200-R with rebar		Ø8	Ø10	Ø12	Ø14	Ø16	Ø20	Ø25	Ø28	Ø32	
Non-cracked concrete temperature range I <sup>2)</sup> : 40°C / 24°C											
Displacement	$\delta_{N0}$ [mm/(N/mm <sup>2</sup> )]	0,02	0,03	0,03	0,04	0,04	0,06	0,07	0,08	0,09	
	$\delta_{N\infty}$ [mm/(N/mm <sup>2</sup> )]	0,04	0,05	0,06	0,07	0,08	0,10	0,13	0,15	0,17	
Non-cracked concrete temperature range II <sup>2)</sup> : 80°C / 50°C											
Displacement	$\delta_{N0}$ [mm/(N/mm <sup>2</sup> )]	0,03	0,04	0,05	0,05	0,06	0,08	0,10	0,11	0,12	
	$\delta_{N\infty}$ [mm/(N/mm <sup>2</sup> )]	0,04	0,05	0,06	0,07	0,09	0,11	0,14	0,15	0,17	
Non-cracked concrete temperature range III <sup>2)</sup> : 120°C / 72°C											
Displacement	$\delta_{N0}$ [mm/(N/mm <sup>2</sup> )]	0,04	0,05	0,06	0,07	0,08	0,10	0,12	0,14	0,16	
	$\delta_{N\infty}$ [mm/(N/mm <sup>2</sup> )]	0,04	0,05	0,07	0,08	0,09	0,11	0,14	0,16	0,18	
Cracked concrete temperature range I <sup>2)</sup> : 40°C / 24°C											
Displacement	$\delta_{N0}$ [mm/(N/mm <sup>2</sup> )]						0,11				
	$\delta_{N\infty}$ [mm/(N/mm <sup>2</sup> )]						0,16				
Cracked concrete temperature range II <sup>2)</sup> : 80°C / 50°C											
Displacement	$\delta_{N0}$ [mm/(N/mm <sup>2</sup> )]						0,15				
	$\delta_{N\infty}$ [mm/(N/mm <sup>2</sup> )]						0,22				
Cracked concrete temperature range III <sup>2)</sup> : 120°C / 72°C											
Displacement	$\delta_{N0}$ [mm/(N/mm <sup>2</sup> )]						0,20				
	$\delta_{N\infty}$ [mm/(N/mm <sup>2</sup> )]						0,29				

<sup>1)</sup> Calculation of displacement under service load:  $\tau_{sd}$  design value of bond stress  
Displacement under short term loading =  $\delta_{N0} \times \tau_{sd}/1,4$ ;  
Displacement under long term loading =  $\delta_{N\infty} \times \tau_{sd}/1,4$ .

<sup>2)</sup> Explanation see section 1.2.

**Table 17: Displacement under shear load <sup>1)</sup> of rebar for static and quasi-static loading**

Hilti HIT-HY 200-R with rebar		Ø8	Ø10	Ø12	Ø14	Ø16	Ø20	Ø25	Ø28	Ø32
Displacement	$\delta_{V0}$ [mm/kN]	0,06	0,05	0,05	0,04	0,04	0,04	0,03	0,03	0,03
	$\delta_{V\infty}$ [mm/kN]	0,09	0,08	0,07	0,06	0,06	0,05	0,05	0,04	0,04

<sup>1)</sup> Calculation of displacement under service load:  $V_{sd}$  design value of shear stress  
Displacement under short term loading =  $\delta_{V0} \times V_d/1,4$ ;  
Displacement under long term loading =  $\delta_{V\infty} \times V_d/1,4$ .

**Injection system Hilti HIT-HY 200-R**

**Annex 17**

**Displacements  
for rebar in case of static and quasi-static loading**



**Table 18: Characteristic tension resistance of internal threaded sleeve HIS-(R)N for static and quasi-static loading**

Hilti HIT-HY 200-R with HIS-(R)N		M8	M10	M12	M16	M20
<b>Steel failure HIS-(R)N</b>						
Characteristic resistance HIS-N with screw grade 8.8	$N_{Rk,s}$ [kN]	25	46	67	118	109
Partial safety factor	$\gamma_{Ms,N}^{1)}$ [-]	1,43	1,50		1,47	
Characteristic resistance HIS-RN with screw grade 70	$N_{Rk,s}$ [kN]	26	41	59	110	166
Partial safety factor	$\gamma_{Ms,N}^{1)}$ [-]	1,87				2,4
<b>Combined pull-out and Concrete cone failure <sup>3)</sup></b>						
Effective anchorage depth	$h_{ef}$ [mm]	90	110	125	170	205
Effective anchor diameter	$d_1$ [mm]	12,5	16,5	20,5	25,4	27,6
Characteristic bond resistance in non-cracked concrete C20/25						
Temp. range I <sup>4)</sup> : 40°C/24°C	$\tau_{Rk,ucr}$ [N/mm <sup>2</sup> ]	13				
Temp. range II <sup>4)</sup> : 80°C/50°C	$\tau_{Rk,ucr}$ [N/mm <sup>2</sup> ]	11				
Temp. range III <sup>4)</sup> : 120°C/72°C	$\tau_{Rk,ucr}$ [N/mm <sup>2</sup> ]	9,5				
Characteristic bond resistance in cracked concrete C20/25						
Temp. range I <sup>4)</sup> : 40°C/24°C	$\tau_{Rk,cr}$ [N/mm <sup>2</sup> ]	7				
Temp. range II <sup>4)</sup> : 80°C/50°C	$\tau_{Rk,cr}$ [N/mm <sup>2</sup> ]	5,5				
Temp. range III <sup>4)</sup> : 120°C/72°C	$\tau_{Rk,cr}$ [N/mm <sup>2</sup> ]	5				
Partial safety factor	$\gamma_{Mp} = \gamma_{Mc} = \gamma_{Msp}^{1)}$ [-]	1,5 <sup>2)</sup>				
Increasing factor for $\tau_{Rk}$ in concrete	$\psi_c$ [-]	1,0				
<b>Splitting failure relevant for non-cracked concrete <sup>3)</sup></b>						
Edge distance $c_{cr,sp}$ [mm] for	$h / h_{ef}^{5)} \geq 2,0$	1,0 · $h_{ef}$				
	$2,0 > h / h_{ef}^{5)} > 1,3$	4,6 $h_{ef}$ - 1,8 h				
	$h / h_{ef}^{5)} \leq 1,3$	2,26 $h_{ef}$				
Spacing	$s_{cr,sp}$ [mm]	2 $c_{cr,sp}$				

- 1) In absence of national regulations.
- 2) The partial safety factor  $\gamma_2 = 1,0$  is included.
- 3) Calculation of concrete failure and splitting see section 4.2.
- 4) Explanation in section 1.2.
- 5)  $h$  = thickness of base material;  $h_{ef}$  = anchorage depth.

**Injection system Hilti HIT-HY 200-R**

**Annex 18**

**Characteristic tension resistance of internal threaded sleeves HIS-(R)N for static and quasi-static loading**

**Table 19: Characteristic shear resistance of internal threaded sleeve HIS-(R)N for static and quasi-static loading**

Hilti HIT-HY 200-R with HIS-(R)N		M8	M10	M12	M16	M20
<b>Steel failure without lever arm</b>						
Characteristic resistance HIS-N with screw grade 8.8	$V_{Rk,s}$ [kN]	13	23	39	59	55
Partial safety factor	$\gamma_{Ms,V}^{1)}$ [-]	1,25		1,5		
Characteristic resistance HIS-RN with screw grade 70	$V_{Rk,s}$ [kN]	13	20	30	55	83
Partial safety factor	$\gamma_{Ms,V}^{1)}$ [-]	1,56				2,0
<b>Steel failure with lever arm</b>						
Characteristic resistance HIS-N with screw grade 8.8	$M^o_{Rk,s}$ [Nm]	30	60	105	266	519
Partial safety factor	$\gamma_{Ms,V}^{1)}$ [-]	1,25				
Characteristic resistance HIS-RN with screw grade 70	$M^o_{Rk,s}$ [Nm]	26	52	92	233	454
Partial safety factor	$\gamma_{Ms,V}^{1)}$ [-]	1,56				
<b>Concrete pry-out failure</b>						
Factor in equation (5.7) of Technical Report TR 029 for the design of bonded anchors	k [-]	2,0				
Partial safety factor	$\gamma_{Mcp}^{1)}$ [-]	1,5 <sup>2)</sup>				
<b>Concrete edge failure</b>						
See section 5.2.3.4 of Technical Report TR 029 for the design of bonded anchors						
Partial safety factor	$\gamma_{Mc}^{1)}$ [-]	1,5 <sup>2)</sup>				

<sup>1)</sup> In absence of national regulations.

<sup>2)</sup> The partial safety factor  $\gamma_2 = 1,0$  is included.

**Injection system Hilti HIT-HY 200-R**

**Annex 19**

**Characteristic shear resistance of internal threaded sleeves HIS-(R)N for static and quasi-static loading**

**Table 20: Displacements under tension load <sup>1)</sup> of internal threaded sleeve HIS-(R)N for static and quasi-static loading**

Hilti HIT-HY 200-R with HIS-(R)N		M8	M10	M12	M16	M20
Non-cracked concrete temperature range I <sup>2)</sup> : 40°C / 24°C						
Displacement	$\delta_{N0}$ [mm/(N/mm <sup>2</sup> )]	0,03	0,05	0,06	0,07	0,08
	$\delta_{N\infty}$ [mm/(N/mm <sup>2</sup> )]	0,06	0,09	0,11	0,13	0,14
Non-cracked concrete temperature range II <sup>2)</sup> : 80°C / 50°C						
Displacement	$\delta_{N0}$ [mm/(N/mm <sup>2</sup> )]	0,05	0,06	0,08	0,10	0,11
	$\delta_{N\infty}$ [mm/(N/mm <sup>2</sup> )]	0,07	0,09	0,11	0,13	0,15
Non-cracked concrete temperature range III <sup>2)</sup> : 120°C / 72°C						
Displacement	$\delta_{N0}$ [mm/(N/mm <sup>2</sup> )]	0,06	0,08	0,10	0,13	0,14
	$\delta_{N\infty}$ [mm/(N/mm <sup>2</sup> )]	0,07	0,09	0,11	0,14	0,15
Cracked concrete temperature range I <sup>2)</sup> : 40°C / 24°C						
Displacement	$\delta_{N0}$ [mm/(N/mm <sup>2</sup> )]	0,11				
	$\delta_{N\infty}$ [mm/(N/mm <sup>2</sup> )]	0,16				
Cracked concrete temperature range II <sup>2)</sup> : 80°C / 50°C						
Displacement	$\delta_{N0}$ [mm/(N/mm <sup>2</sup> )]	0,15				
	$\delta_{N\infty}$ [mm/(N/mm <sup>2</sup> )]	0,22				
Cracked concrete temperature range III <sup>2)</sup> : 120°C / 72°C						
Displacement	$\delta_{N0}$ [mm/(N/mm <sup>2</sup> )]	0,20				
	$\delta_{N\infty}$ [mm/(N/mm <sup>2</sup> )]	0,29				

<sup>1)</sup> Calculation of displacement under service load:  $\tau_{Sd}$  design value of tension load

Displacement under short term loading =  $\delta_{N0} \times \tau_{Sd} / 1,4$ ;

Displacement under long term loading =  $\delta_{N\infty} \times \tau_{Sd} / 1,4$ .

<sup>2)</sup> Explanation see section 1.2.

**Table 21: Displacement under shear load <sup>1)</sup> for internal threaded sleeve HIS-(R)N for static and quasi-static loading**

Hilti HIT-HY 200-R with HIS-(R)N		M8	M10	M12	M16	M20
Displacement	$\delta_{V0}$ [mm/kN]	0,06	0,06	0,05	0,04	0,04
	$\delta_{V\infty}$ [mm/kN]	0,09	0,08	0,08	0,06	0,06

<sup>1)</sup> Calculation of displacement under service load:  $V_d$  design value of shear load

Displacement under short term loading =  $\delta_{V0} \times V_d / 1,4$ ;

Displacement under long term loading =  $\delta_{V\infty} \times V_d / 1,4$  ( $V_d$ : design value of shear action).

**Injection system Hilti HIT-HY 200-R**

**Annex 20**

**Displacements of internal threaded sleeves HIS-(R)N  
for static and quasi-static loading**

**Table 22: Characteristic tension resistance of tension anchor HZA and HZA-R for static and quasi-static loading**

Hilti HIT-HY 200-R with HZA, HZA-R				M12	M16	M20	M24	M27
<b>Steel failure</b>								
Characteristic resistance HZA	$N_{Rk,s}$	[kN]		46	86	135	194	253
Characteristic resistance HZA-R	$N_{Rk,s}$	[kN]		62	111	173	248	-
Partial safety factor	$\gamma_{Ms}^{1)}$	[-]		1,4				
<b>Combined pull-out and concrete cone failure <sup>3)</sup></b>								
Diameter of rebar	d	[mm]		12	16	20	25	28
Characteristic bond resistance in non-cracked concrete C20/25								
Temperature range I <sup>4)</sup> :	40°C/24°C	$\tau_{Rk,ucr}$	[N/mm <sup>2</sup> ]	12				
Temperature range II <sup>4)</sup> :	80°C/50°C	$\tau_{Rk,ucr}$	[N/mm <sup>2</sup> ]	10				
Temperature range III <sup>4)</sup> :	120°C/72°C	$\tau_{Rk,ucr}$	[N/mm <sup>2</sup> ]	8,5				
Characteristic bond resistance in cracked concrete C20/25								
Temperature range I <sup>4)</sup> :	40°C/24°C	$\tau_{Rk,cr}$	[N/mm <sup>2</sup> ]	7				
Temperature range II <sup>4)</sup> :	80°C/50°C	$\tau_{Rk,cr}$	[N/mm <sup>2</sup> ]	5,5				
Temperature range III <sup>4)</sup> :	120°C/72°C	$\tau_{Rk,cr}$	[N/mm <sup>2</sup> ]	5				
Partial safety factor	$\gamma_{Mp} = \gamma_{Mc} = \gamma_{Msp}^{1)}$	[-]		1,5 <sup>2)</sup>				
Increasing factor for $\tau_{Rk}$ in concrete	$\psi_c$	[-]		1,0				
Effective anchorage depth for calculation of $N_{Rk,p}^0$ acc. Eq. 5.2a (TR 029, 5.2.2.3 Combined pull-out and concrete cone failure)	HZA	$h_{ef}$	[mm]	$h_{nom}^{6)} - 20$				
	HZA-R	$h_{ef}$	[mm]	$h_{nom}^{6)} - 100$				
<b>Concrete cone failure <sup>3)</sup></b>								
Effective anchorage depth for calculation of $N_{Rk,c}^0$ acc. Eq. 5.3a (TR 029, 5.2.2.4 Concrete cone failure)	HZA HZA-R	$h_{ef}$	[mm]	$h_{nom}^{6)}$				
<b>Splitting failure relevant for non-cracked concrete <sup>3)</sup></b>								
Edge distance $c_{cr,sp}$ [mm] for	$h / h_{ef}^{5)} \geq 2,0$			$1,0 \cdot h_{ef}$				
	$2,0 > h / h_{ef}^{5)} > 1,3$			$4,6 h_{ef} - 1,8 h$				
	$h / h_{ef}^{5)} \leq 1,3$			$2,26 h_{ef}$				
Spacing	$s_{cr,sp}$	[mm]		$2 c_{cr,sp}$				

- 1) In absence of national regulations.
- 2) The partial safety factor  $\gamma_2 = 1,0$  is included.
- 3) Calculation of concrete failure and splitting see section 4.2.
- 4) Explanation see section 1.2.
- 5)  $h$  = thickness of base material;  $h_{ef}$  = anchorage depth.
- 6) Limits of  $h_{nom}$  see Table 5 for HZA-R and Table 6 for HZA.

**Injection system Hilti HIT-HY 200-R**

**Annex 21**

**Characteristic tension resistance of tension anchor HZA and HZA-R for static and quasi-static loading**

**Table 23: Characteristic shear resistance of tension anchor HZA and HZA-R for static and quasi-static loading**

Hilti HIT-HY 200-R with HZA, HZA-R		M12	M16	M20	M24	M27
<b>Steel failure without lever arm</b>						
Characteristic resistance HZA	$V_{Rk,s}$ [kN]	23	43	67	97	126
Characteristic resistance HZA-R	$V_{Rk,s}$ [kN]	31	55	86	124	-
Partial safety factor	$\gamma_{Ms}^{1)}$ [-]	1,25				
<b>Steel failure with lever arm</b>						
Characteristic resistance HZA	$M_{Rk,s}^0$ [Nm]	72	183	357	617	915
Characteristic resistance HZA-R	$M_{Rk,s}^0$ [Nm]	97	234	457	790	-
Partial safety factor	$\gamma_{Ms}^{1)}$ [-]	1,5				
<b>Concrete pry-out failure</b>						
Factor in equation (5.7) of Technical Report TR 029 for the design of bonded anchors	k [-]	2,0				
Partial safety factor	$\gamma_{Mcp}^{1)}$ [-]	1,5 <sup>2)</sup>				
<b>Concrete edge failure</b>						
See section 5.2.3.4 of Technical Report TR 029 for the design of bonded anchors						
Partial safety factor	$\gamma_{Mc}^{1)}$ [-]	1,5 <sup>2)</sup>				

<sup>1)</sup> In absence of national regulations.

<sup>2)</sup> The partial safety factor  $\gamma_2 = 1,0$  is included.

**Injection system Hilti HIT-HY 200-R**

**Annex 22**

**Characteristic shear resistance  
of tension anchor HZA and HZA-R for static and quasi-static loading**

**Table 24: Displacements under tension load <sup>1)</sup> of tension anchor HZA and HZA-R for static and quasi-static loading**

Hilti HIT-HY 200-R with HZA, HZA-R			M12	M16	M20	M24	M27
Non-cracked concrete temperature range I <sup>2)</sup> : 40°C / 24°C							
Displacement	$\delta_{N0}$	[mm/(N/mm <sup>2</sup> )]	0,03	0,04	0,06	0,07	0,08
	$\delta_{N\infty}$	[mm/(N/mm <sup>2</sup> )]	0,06	0,08	0,13	0,13	0,15
Non-cracked concrete temperature range II <sup>2)</sup> : 80°C / 50°C							
Displacement	$\delta_{N0}$	[mm/(N/mm <sup>2</sup> )]	0,05	0,06	0,08	0,10	0,11
	$\delta_{N\infty}$	[mm/(N/mm <sup>2</sup> )]	0,06	0,09	0,14	0,14	0,15
Non-cracked concrete temperature range III <sup>2)</sup> : 120°C / 72°C							
Displacement	$\delta_{N0}$	[mm/(N/mm <sup>2</sup> )]	0,06	0,08	0,10	0,12	0,14
	$\delta_{N\infty}$	[mm/(N/mm <sup>2</sup> )]	0,07	0,09	0,14	0,14	0,16
Cracked concrete temperature range I <sup>2)</sup> : 40°C / 24°C							
Displacement	$\delta_{N0}$	[mm/(N/mm <sup>2</sup> )]	0,11				
	$\delta_{N\infty}$	[mm/(N/mm <sup>2</sup> )]	0,16				
Cracked concrete temperature range II <sup>2)</sup> : 80°C / 50°C							
Displacement	$\delta_{N0}$	[mm/(N/mm <sup>2</sup> )]	0,15				
	$\delta_{N\infty}$	[mm/(N/mm <sup>2</sup> )]	0,22				
Cracked concrete temperature range III <sup>2)</sup> : 120°C / 72°C							
Displacement	$\delta_{N0}$	[mm/(N/mm <sup>2</sup> )]	0,20				
	$\delta_{N\infty}$	[mm/(N/mm <sup>2</sup> )]	0,29				

<sup>1)</sup> Calculation of displacement under service load:  $\tau_{sd}$  design value of bond stress

Displacement under short term loading =  $\delta_{N0} \times \tau_{sd}/1,4$ ;

Displacement under long term loading =  $\delta_{N\infty} \times \tau_{sd}/1,4$ .

<sup>2)</sup> Explanation see section 1.2.

**Table 25: Displacement under shear load <sup>1)</sup> of tension anchor HZA and HZA-R for static and quasi-static loading**

Hilti HIT-HY 200-R with HZA, HZA-R			M12	M16	M20	M24	M27
Displacement	$\delta_{V0}$	[mm/kN]	0,05	0,04	0,04	0,03	0,03
	$\delta_{V\infty}$	[mm/kN]	0,08	0,06	0,06	0,05	0,05

<sup>1)</sup> Calculation of displacement under service load:  $V_{sd}$  design value of shear stress

Displacement under short term loading =  $\delta_{V0} \times V_d/1,4$ ;

Displacement under long term loading =  $\delta_{V\infty} \times V_d/1,4$ .

**Injection system Hilti HIT-HY 200-R**

**Annex 23**

**Displacements of tension anchor HZA and HZA-R for static and quasi-static loading**



**Table 26: Characteristic tension resistance of threaded rod HIT-V for seismic performance category C1**

Hilti HIT-HY 200-R with HIT-V-...	M8	M10	M12	M16	M20	M24	M27	M30
<b>Steel failure</b>								
Characteristic resistance HIT-V-5.8(F) $N_{Rk,s,seis}$ [kN]	-	29	42	79	123	177	230	281
Characteristic resistance HIT-V-8.8(F) $N_{Rk,s,seis}$ [kN]	-	46	67	126	196	282	367	449
Partial safety factor $\gamma_{Ms,seis}^{1)}$ [-]	1,5							
Characteristic resistance HIT-V-R $N_{Rk,s,seis}$ [kN]	-	41	59	110	172	247	230	281
Partial safety factor $\gamma_{Ms,seis}^{1)}$ [-]	1,87						2,86	
Characteristic resistance HIT-V-HCR $N_{Rk,s,seis}$ [kN]	-	46	67	126	196	247	321	393
Partial safety factor $\gamma_{Ms,seis}^{1)}$ [-]	1,5					2,1		
<b>Combined pull-out and concrete cone failure <sup>3)</sup></b>								
Diameter of threaded rod $d$ [mm]	-	10	12	16	20	24	27	30
Characteristic bond resistance in cracked concrete C20/25								
Temp. range I <sup>4)</sup> : 40°C/24°C $\tau_{Rk,seis}$ [N/mm <sup>2</sup> ]	-	5,2	7,0					
Temp. range II <sup>4)</sup> : 80°C/50°C $\tau_{Rk,seis}$ [N/mm <sup>2</sup> ]	-	3,9	5,7					
Temp. range III <sup>4)</sup> : 120°C/72°C $\tau_{Rk,seis}$ [N/mm <sup>2</sup> ]	-	3,5	4,8					
Partial safety factor $\gamma_{Mp,seis}^{1)}$ [-]	1,8 <sup>2)</sup>							
<b>Concrete cone failure <sup>3)</sup></b>								
Partial safety factor $\gamma_{Mc,seis}^{1)}$ [-]	1,8 <sup>2)</sup>							
<b>Splitting failure <sup>3)</sup></b>								
Partial safety factor $\gamma_{Msp,seis}^{1)}$ [-]	1,8 <sup>2)</sup>							
<sup>1)</sup> In absence of national regulations. <sup>2)</sup> The partial safety factor $\gamma_2 = 1,2$ is included. <sup>3)</sup> Calculation of concrete failure and splitting see Annex 31. <sup>4)</sup> Explanation in section 1.2.								
The definition of seismic performance category C1 is given in Annex 30.								
<b>Injection system Hilti HIT-HY 200-R</b>						<b>Annex 24</b>		
<b>Characteristic tension resistance of threaded rod HIT-V for seismic loading, performance category C1</b>								

**Table 27: Characteristic shear resistance of threaded rod HIT-V for seismic loading, performance category C1**

Hilti HIT-HY 200-R with HIT-V-...		M8	M10	M12	M16	M20	M24	M27	M30
<b>Steel failure without lever arm</b>									
Characteristic resistance HIT-V-5.8(F)	$V_{Rk,s,seis}$ [kN]	-	11	15	27	43	62	81	98
Characteristic resistance HIT-V-8.8(F)	$V_{Rk,s,seis}$ [kN]	-	16	24	44	69	99	129	157
Partial safety factor	$\gamma_{Ms,seis}^{1)}$ [-]	1,25							
Characteristic resistance HIT-V-R	$V_{Rk,s,seis}$ [kN]	-	14	21	39	60	87	81	98
Partial safety factor HIT-V-R	$\gamma_{Ms,seis}^{1)}$ [-]	1,56						2,38	
Characteristic resistance HIT-V-HCR	$V_{Rk,s,seis}$ [kN]	-	16	24	44	69	87	113	137
Partial safety factor HIT-V-HCR	$\gamma_{Ms,seis}^{1)}$ [-]	1,25					1,75		
<b>Concrete pry-out failure <sup>3)</sup></b>									
Partial safety factor	$\gamma_{Mcp,seis}^{1)}$ [-]	1,5 <sup>2)</sup>							
<b>Concrete edge failure <sup>3)</sup></b>									
Partial safety factor	$\gamma_{Mc,seis}^{1)}$ [-]	1,5 <sup>2)</sup>							

<sup>1)</sup> In absence of national regulations.

<sup>2)</sup> The partial safety factor  $\gamma_2 = 1,0$  is included.

<sup>3)</sup> For concrete pry-out failure and concrete edge failure see Annex 31.

**Table 28: Displacements under tension load of threaded rod HIT-V for seismic loading, performance category C1**

Hilti HIT-HY 200-R with HIT-V-...		M8	M10	M12	M16	M20	M24	M27	M30
Displacement <sup>1)</sup>	$\delta_{N,seis}$ [mm]	-	0,8	0,8	0,8	0,8	0,8	0,8	0,8

<sup>1)</sup> Maximum displacement during cycling (seismic event).

**Table 29: Displacement under shear load of threaded rod HIT-V for seismic loading, performance category C1**

Hilti HIT-HY 200-R with HIT-V-...		M8	M10	M12	M16	M20	M24	M27	M30
Displacement <sup>1)</sup>	$\delta_{V,seis}$ [mm]	-	3,5	3,8	4,4	5,0	5,6	6,1	6,5

<sup>1)</sup> Maximum displacement during cycling (seismic event).

The definition of seismic performance category C1 is given in Annex 30.

**Injection system Hilti HIT-HY 200-R**

**Annex 25**

**Characteristic shear resistance and displacements of threaded rod HIT-V for seismic loading, performance category C1**

**Table 30: Characteristic tension resistance of rebar  
for seismic loading, performance category C1**

Hilti HIT-HY 200-R with rebar		Ø8	Ø10	Ø12	Ø14	Ø16	Ø20	Ø25	Ø28	Ø32
<b>Steel failure</b>										
Characteristic resistance for rebar B500B acc. to DIN 488:2009-08 <sup>5)</sup>	$N_{Rk,s,seis}$ [kN]	-	43	62	85	111	173	270	339	442
Partial safety factor for rebar B500B acc. to DIN 488:2009-08 <sup>6)</sup>	$\gamma_{Ms,seis}$ <sup>1)</sup> [-]	1,4								
<b>Combined pull-out and concrete cone failure<sup>3)</sup></b>										
Diameter of rebar	d [mm]	-	10	12	14	16	20	25	28	32
Characteristic bond resistance in cracked concrete C20/25										
Temp. range I <sup>4)</sup> : 40°C/24°C	$\tau_{Rk,seis}$ [N/mm <sup>2</sup> ]	-	4,4				6,1			
Temp. range II <sup>4)</sup> : 80°C/50°C	$\tau_{Rk,seis}$ [N/mm <sup>2</sup> ]	-	3,5				4,8			
Temp. range III <sup>4)</sup> : 120°C/72°C	$\tau_{Rk,seis}$ [N/mm <sup>2</sup> ]	-	3				4,4			
Partial safety factor	$\gamma_{Mp,seis}$ <sup>1)</sup> [-]	1,5 <sup>2)</sup>								
<b>Concrete cone failure<sup>3)</sup></b>										
Partial safety factor	$\gamma_{Mc,seis}$ <sup>1)</sup> [-]	1,5 <sup>2)</sup>								
<b>Splitting failure<sup>3)</sup></b>										
Partial safety factor	$\gamma_{Msp,seis}$ <sup>1)</sup> [-]	1,5 <sup>2)</sup>								

1) In absence of national regulations.

2) The partial safety factor  $\gamma_2 = 1,0$  is included.

3) Calculation of concrete failure and splitting failure see Annex 31.

4) Explanation in section 1.2.

5) The characteristic tension resistance  $N_{Rk,s,seis}$  for rebars that do not fulfil the requirements acc. DIN 488 shall be calculated acc. Technical Report TR 029, Equation (5.1),  $N_{Rk,s,seis} = N_{Rk,s}$ .

6) The partial safety factor  $\gamma_{Ms,seis}$  for rebars that do not fulfil the requirements acc. DIN 488 shall be calculated acc. Technical Report TR 029, Equation (3.3a),  $\gamma_{Ms,seis} = \gamma_{Ms}$ .

The definition of seismic performance category C1 is given in Annex 30.

**Injection system Hilti HIT-HY 200-R**

**Annex 26**

**Characteristic tension resistance  
of rebar for seismic loading, performance category C1**

**Table 31: Characteristic shear resistance of rebar  
for seismic loading, performance category C1**

Hilti HIT-HY 200-R with rebar		Ø8	Ø10	Ø12	Ø14	Ø16	Ø20	Ø25	Ø28	Ø32
<b>Steel failure without lever arm</b>										
Characteristic resistance rebar B500B acc. to DIN 488:2009-08 <sup>4)</sup>	$V_{Rk,seis}$ [kN]	-	15	22	29	39	60	95	118	155
Partial safety factor rebar B500B acc. to DIN 488:2009-08 <sup>5)</sup>	$\gamma_{Ms,seis}$ <sup>1)</sup> [-]	1,5								
<b>Concrete pry-out failure <sup>3)</sup></b>										
Partial safety factor	$\gamma_{Mcp,seis}$ <sup>1)</sup> [-]	1,5 <sup>2)</sup>								
<b>Concrete edge failure <sup>3)</sup></b>										
Partial safety factor	$\gamma_{Mc,seis}$ <sup>1)</sup> [-]	1,5 <sup>2)</sup>								

<sup>1)</sup> In absence of national regulations.

<sup>2)</sup> The partial safety factor  $\gamma_2 = 1,0$  is included.

<sup>3)</sup> For concrete pry-out failure and concrete edge failure see Annex 31.

<sup>4)</sup> The characteristic shear resistance  $V_{Rk,s,seis}$  for rebars that do not fulfil the requirements acc. DIN 488 shall be calculated acc. Technical Report TR 029, Equation (5.5),  $V_{Rk,s,seis} = 0,7 \times V_{Rk,s}$ .

<sup>5)</sup> The partial safety factor  $\gamma_{Ms,seis}$  for rebars that do not fulfil the requirements acc. DIN 488 shall be calculated acc. Technical Report TR 029, Equation (3.3b) or (3.3c),  $\gamma_{Ms,seis} = \gamma_{Ms}$ .

**Table 32: Displacements under tension load of rebar  
for seismic loading, performance category C1**

Hilti HIT-HY 200-R with rebar		Ø8	Ø10	Ø12	Ø14	Ø16	Ø20	Ø25	Ø28	Ø32
Displacement <sup>1)</sup>	$\delta_{N,seis}$ [mm]	-	1,3	1,3	1,3	1,3	1,3	1,3	1,3	1,3

<sup>1)</sup> Maximum displacement during cycling (seismic event).

**Table 33: Displacement under shear load of rebar  
for seismic loading, performance category C1**

Hilti HIT-HY 200-R with rebar		Ø8	Ø10	Ø12	Ø14	Ø16	Ø20	Ø25	Ø28	Ø32
Displacement <sup>1)</sup>	$\delta_{V,seis}$ [mm]	-	3,5	3,8	4,1	4,4	5,0	5,8	6,2	6,8

<sup>1)</sup> Maximum displacement during cycling (seismic event).

The definition of seismic performance category C1 is given in Annex 30.

**Injection system Hilti HIT-HY 200-R**

**Annex 27**

**Characteristic shear resistance and displacements  
of rebar for seismic loading, performance category C1**

**Table 34: Characteristic tension resistance of tension anchor HZA and HZA-R for seismic loading, performance category C1**

Hilti HIT-HY 200-R with HZA, HZA-R			M12	M16	M20	M24	M27
<b>Steel failure</b>							
Characteristic resistance HZA	$N_{Rk,s,seis}$ [kN]		46	86	135	194	253
Characteristic resistance HZA-R	$N_{Rk,s,seis}$ [kN]		62	111	173	248	-
Partial safety factor	$\gamma_{Ms,seis}^{1)}$ [-]		1,4				
<b>Combined pull-out and concrete cone failure <sup>3)</sup></b>							
Diameter of rebar	d [mm]		12	16	20	25	28
Characteristic bond resistance in cracked concrete C20/25							
Temperature range I <sup>4)</sup> :	40°C/24°C	$\tau_{Rk,seis}$ [N/mm <sup>2</sup> ]	6,1				
Temperature range II <sup>4)</sup> :	80°C/50°C	$\tau_{Rk,seis}$ [N/mm <sup>2</sup> ]	4,8				
Temperature range III <sup>4)</sup> :	120°C/72°C	$\tau_{Rk,seis}$ [N/mm <sup>2</sup> ]	4,4				
Partial safety factor	$\gamma_{Mp,seis}^{1)}$ [-]		1,5 <sup>2)</sup>				
<b>Concrete cone failure <sup>3)</sup></b>							
Partial safety factor	$\gamma_{Mc,seis}^{1)}$ [-]		1,5 <sup>2)</sup>				
<b>Splitting failure <sup>3)</sup></b>							
Partial safety factor	$\gamma_{Msp,seis}^{1)}$ [-]		1,5 <sup>2)</sup>				

- 1) In absence of national regulations.  
 2) The partial safety factor  $\gamma_2 = 1,0$  is included.  
 3) Calculation of concrete failure and splitting failure see Annex 31.  
 4) Explanation see section 1.2.

The definition of seismic performance category C1 is given in Annex 30.

**Injection system Hilti HIT-HY 200-R**

**Annex 28**

**Characteristic values for tension load for tension anchor HZA, HZA-R in case of seismic performance category C1**

**Table 35: Characteristic shear resistance of tension anchor HZA and HZA-R for seismic loading, performance category C1**

Hilti HIT-HY 200-R with HZA, HZA-R		M12	M16	M20	M24	M27
<b>Steel failure without lever arm</b>						
Characteristic resistance HZA	$V_{Rk,s,seis}$ [kN]	16	30	47	68	88
Characteristic resistance HZA-R	$V_{Rk,s,seis}$ [kN]	22	39	60	87	-
Partial safety factor	$\gamma_{Ms,seis}^{1)}$ [-]	1,25				
<b>Concrete pry-out failure <sup>3)</sup></b>						
Partial safety factor	$\gamma_{Mcp,seis}^{1)}$ [-]	1,5 <sup>2)</sup>				
<b>Concrete edge failure <sup>3)</sup></b>						
Partial safety factor	$\gamma_{Mc,seis}^{1)}$ [-]	1,5 <sup>2)</sup>				

<sup>1)</sup> In absence of national regulations.

<sup>2)</sup> The partial safety factor  $\gamma_2 = 1,0$  is included.

<sup>3)</sup> For concrete pry-out failure and concrete edge failure see Annex 31.

**Table 36: Displacements under tension load of tension anchor HZA and HZA-R for seismic loading, performance category C1**

Hilti HIT-HY 200-R with HZA, HZA-R		M12	M16	M20	M24	M27
Displacement <sup>1)</sup>	$\delta_{N,seis}$ [mm]	1,3	1,3	1,3	1,3	1,3

<sup>1)</sup> Maximum displacement during cycling (seismic event).

**Table 37: Displacement under shear load of tension anchor HZA and HZA-R for seismic loading, performance category C1**

Hilti HIT-HY 200-R with HZA, HZA-R		M12	M16	M20	M24	M27
Displacement <sup>1)</sup>	$\delta_{V,seis}$ [mm]	3,8	4,4	5,0	5,6	6,1

<sup>1)</sup> Maximum displacement during cycling (seismic event).

The definition of seismic performance category C1 is given in Annex 30.

**Injection system Hilti HIT-HY 200-R**

**Annex 29**

**Characteristic shear resistance and displacements of tension anchor HZA and HZA-R for seismic loading performance category C1**



**Table 38: Recommended seismic performance categories <sup>1)</sup> for anchors**

Seismicity level <sup>a</sup>		Importance Class acc. to EN 1998-1:2004, 4.2.5			
Class	$a_g \cdot S^c$	I	II	III	IV
Very low <sup>b</sup>	$a_g \cdot S \leq 0,05 g$	No additional requirement			
Low <sup>b</sup>	$0,05 g < a_g \cdot S \leq 0,1 g$	C1	C1 <sup>d</sup> or C2 <sup>e</sup>		C2
> low	$a_g \cdot S > 0,1 g$	C1	C2		

<sup>a</sup> The values defining the seismicity levels may be found in the National Annex of EN 1998-1.

<sup>b</sup> Definition according to EN 1998-1: 2004, 3.2.1.

<sup>c</sup>  $a_g$  = Design ground acceleration on Type A ground (EN 1998-1: 2004, 3.2.1),  
 $S$  = Soil factor (see e.g. EN 1998-1: 2004, 3.2.2).

<sup>d</sup> C1 for attachments of non-structural elements

<sup>e</sup> C2 for connections between structural elements of primary and/or secondary seismic members

<sup>1)</sup> The seismic performance of anchors subjected to seismic loading is categorized by performance categories C1 and C2.

Table 38 relates the seismic performance categories C1 and C2 to the seismicity level and building importance class. The level of seismicity is defined as a function of the product  $a_g \cdot S$ , where  $a_g$  is the design ground acceleration on Type A ground and  $S$  the soil factor, both in accordance with EN 1998-1: 2004.

The value of  $a_g$  or that of the product  $a_g \cdot S$  used in a Member State to define thresholds for the seismicity classes may be found in its National Annex of EN 1998-1 and may be different to the values given in Table 38. Furthermore, the assignment of the seismic performance categories C1 and C2 to the seismicity level and building importance classes is in the responsibility of each individual Member State.

**Injection system Hilti HIT-HY 200-R**

**Annex 30**

**Seismic performance categories**

**Table 39: Reduction factor  $\alpha_{seis}$**

Loading	Failure mode	Single anchor <sup>1)</sup>	Anchor group
tension	Steel failure	1,0	1,0
	Combined pull-out and concrete cone failure	1,0	0,85
	Concrete cone failure	0,85	0,75
	Splitting failure	1,0	0,85
shear	Steel failure	1,0	0,85
	Concrete edge failure	1,0	0,85
	Concrete pry-out failure	0,85	0,75

<sup>1)</sup> In case of tension loading single anchor also addresses situations where only 1 anchor in a group of anchors is subjected to tension.

### Information regarding seismic design

The seismic design shall be carried out according to the TR 045 „Design of Metal Anchors Under Seismic Action“. For every failure mode the characteristic seismic resistance  $R_{k,seis}$  of a fastening shall be determined as follows:

$$R_{k,seis} = \alpha_{gap} \cdot \alpha_{seis} \cdot R_{k,seis}^0$$

where

$\alpha_{gap}$  reduction factor to take into account inertia effects due to an annular gap between anchor and fixture in case of shear loading;

= 1,0 in case of no hole clearance between anchor and fixture;

= 0,5 in case of connections with standard hole clearance according TR 029, Table 4.1

$\alpha_{seis}$  reduction factor to take into account the influence of large cracks and scatter of load displacement curves, see Table 39;

$R_{k,seis}^0$  basic characteristic seismic resistance for a given failure mode:

For steel failure under tension load and steel failure under shear load  $R_{k,seis}^0$  (i.e.  $N_{Rk,s,seis}$ ,  $V_{Rk,s,seis}$ ) shall be taken from Annex 24 to Annex 29 for seismic performance category C1.

For combined pull-out and concrete cone failure  $R_{k,seis}^0$  (i.e.  $N_{Rk,p}$ ) shall be determined as given in TR 029, however, based on the characteristic bond resistance under seismic loading  $\tau_{Rk,seis}$  given in Annex 24, Annex 26 and Annex 28 for seismic performance category C1.

For all other failure modes  $R_{k,seis}^0$  shall be determined as for the design situation for static and quasi-static loading according to TR 029 (i.e.  $N_{Rk,c}$ ,  $N_{Rk,sp}$ ,  $V_{Rk,c}$ ,  $V_{Rk,cp}$ ).

**Injection system Hilti HIT-HY 200-R**

**Annex 31**

**Reduction factors and characteristic seismic resistances**