



European Technical Approval ETA-13/0853

English translation prepared by DIBt - Original version in German language

Handelsbezeichnung <i>Trade name</i>	ChemMates VSF <i>ChemMates VSF</i>
Zulassungsinhaber <i>Holder of approval</i>	IDEAL FASTENERS PTY. LTD. Ausco place 10-12 DANDENONG SOUTH VIC 3175 AUSTRALIEN
Zulassungsgegenstand und Verwendungszweck <i>Generic type and use of construction product</i>	Verbunddübel mit Gewindestange oder Betonstahl zur Verankerung im ungerissenen Beton <i>Bonded anchor with threaded rod or reinforcing bar for use in non-cracked concrete</i>
Geltungsdauer: <i>Validity:</i>	vom <i>from</i> bis <i>to</i> 27 June 2013 6 September 2017
Herstellwerk <i>Manufacturing plant</i>	Plant 1, Ideal Fasteners Pty Ltd.

Diese Zulassung umfasst
This Approval contains

18 Seiten einschließlich 10 Anhänge
18 pages including 10 annexes

I LEGAL BASES AND GENERAL CONDITIONS

- 1 This European technical approval is issued by Deutsches Institut für Bautechnik in accordance with:
 - Council Directive 89/106/EEC of 21 December 1988 on the approximation of laws, regulations and administrative provisions of Member States relating to construction products¹, modified by Council Directive 93/68/EEC² and Regulation (EC) N° 1882/2003 of the European Parliament and of the Council³;
 - *Gesetz über das In-Verkehr-Bringen von und den freien Warenverkehr mit Bauprodukten zur Umsetzung der Richtlinie 89/106/EWG des Rates vom 21. Dezember 1988 zur Angleichung der Rechts- und Verwaltungsvorschriften der Mitgliedstaaten über Bauprodukte und anderer Rechtsakte der Europäischen Gemeinschaften (Bauproduktengesetz - BauPG) vom 28. April 1998⁴, as amended by Article 2 of the law of 8 November 2011⁵;*
 - Common Procedural Rules for Requesting, Preparing and the Granting of European technical approvals set out in the Annex to Commission Decision 94/23/EC⁶;
 - Guideline for European technical approval of "Metal anchors for use in concrete - Part 5: Bonded anchors", ETAG 001-05.
- 2 Deutsches Institut für Bautechnik is authorized to check whether the provisions of this European technical approval are met. Checking may take place in the manufacturing plant. Nevertheless, the responsibility for the conformity of the products to the European technical approval and for their fitness for the intended use remains with the holder of the European technical approval.
- 3 This European technical approval is not to be transferred to manufacturers or agents of manufacturers other than those indicated on page 1, or manufacturing plants other than those indicated on page 1 of this European technical approval.
- 4 This European technical approval may be withdrawn by Deutsches Institut für Bautechnik, in particular pursuant to information by the Commission according to Article 5(1) of Council Directive 89/106/EEC.
- 5 Reproduction of this European technical approval including transmission by electronic means shall be in full. However, partial reproduction can be made with the written consent of Deutsches Institut für Bautechnik. In this case partial reproduction has to be designated as such. Texts and drawings of advertising brochures shall not contradict or misuse the European technical approval.
- 6 The European technical approval is issued by the approval body in its official language. This version corresponds fully to the version circulated within EOTA. Translations into other languages have to be designated as such.

¹ Official Journal of the European Communities L 40, 11 February 1989, p. 12
² Official Journal of the European Communities L 220, 30 August 1993, p. 1
³ Official Journal of the European Union L 284, 31 October 2003, p. 25
⁴ *Bundesgesetzblatt Teil I 1998*, p. 812
⁵ *Bundesgesetzblatt Teil I 2011*, p. 2178
⁶ Official Journal of the European Communities L 17, 20 January 1994, p. 34

II SPECIFIC CONDITIONS OF THE EUROPEAN TECHNICAL APPROVAL

1 Definition of product and intended use

1.1 Definition of the construction product

The "ChemMates VSF" is a bonded anchor consisting of a cartridge with injection mortar "ChemMates VSF" or "ChemMates VSF-LT" and a steel element. The steel elements are threaded rods with washer and hexagon nut according to Annex 3 in the range of M8 to M30 or reinforcing bar according to Annex 4 in the range of Ø 16 to Ø 32.

The steel element is placed into a drilled hole filled with injection mortar and is anchored via the bond between metal part, injection mortar and concrete.

An illustration of the product and intended use is given in Annexes 1 and 2.

1.2 Intended use

The anchor is intended to be used for anchorages for which requirements for mechanical resistance and stability and safety in use in the sense of the Essential Requirements 1 and 4 of Council Directive 89/106 EEC shall be fulfilled and failure of anchorages made with these products would cause risk to human life and/or lead to considerable economic consequences. Safety in case of fire (Essential Requirement 2) is not covered in this European technical approval.

The anchor is to be used only for anchorages subject to static or quasi-static loading in reinforced or unreinforced normal weight concrete of strength classes C20/25 at minimum and C50/60 at most according to EN 206:2000-12.

The anchor may be used in non-cracked concrete only.

The anchor may be installed in dry or wet concrete. It must not be installed in flooded holes.

The anchor may be used in the following temperature ranges:

Temperature range: -40 °C to +80 °C (max long term temperature +72 °C and
max short term temperature +80 °C)

Elements made of zinc coated steel:

The element made of zinc plated steel may only be used in structures subject to dry internal conditions.

Elements made of stainless steel:

The element made of stainless steel 1.4401, 1.4404 or 1.4571 may be used in structures subject to dry internal conditions and also in structures subject to external atmospheric exposure (including industrial and marine environment), or exposure to permanently damp internal conditions, if no particular aggressive conditions exist. Such particular aggressive conditions are e.g. permanent, alternating immersion in seawater or the splash zone of seawater, chloride atmosphere of indoor swimming pools or atmosphere with extreme chemical pollution (e.g. in desulphurization plants or road tunnels where de-icing materials are used).

Elements made of reinforcing bars:

Post-installed reinforcing bars may be used as anchor designed in accordance with the EOTA Technical Report TR 029. Such applications are e.g. concrete overlay or shear dowel connections or the connections of a wall predominantly loaded by shear and compression forces with the foundation, where the reinforcing bars act as dowels to take up shear forces. Connections with post-installed reinforcing bars in concrete structures designed in accordance with EN1992-1-1:2004 are not covered by this European technical approval.

The provisions made in this European technical approval are based on an assumed working life of the anchor of 50 years. The indications given on the working life cannot be interpreted as a guarantee given by the producer, but are to be regarded only as a means for choosing the right products in relation to the expected economically reasonable working life of the works.

2 Characteristics of the product and methods of verification

2.1 Characteristics of the product

The anchor corresponds to the drawings and provisions given in the Annexes. The characteristic material values, dimensions and tolerances of the anchor not indicated in the Annexes shall correspond to the respective values laid down in the technical documentation⁷ of this European technical approval.

The characteristic values for the design of anchorages are given in the Annexes.

The two components of the injection mortar are delivered in unmixed condition in coaxial cartridges of sizes 150ml, 280ml or 410ml or in side-by-side cartridges of size 345ml according to Annex 1.

Each cartridge and each steel element is marked in accordance with the specifications given in the Annexes.

Steel elements made of reinforcing bars shall comply with the specifications given in Annex 4.

The marking of embedment depth may be done on jobsite.

2.2 Methods of verification

The assessment of fitness of the anchor for the intended use in relation to the requirements for mechanical resistance and stability and safety in use in the sense of the Essential Requirements 1 and 4 has been made in accordance with the "Guideline for European technical approval of Metal Anchors for Use in Concrete", Part 1 "Anchors in general" and Part 5 "Bonded anchors", on the basis of Option 7.

In addition to the specific clauses relating to dangerous substances contained in this European technical approval, there may be other requirements applicable to the products falling within its scope (e.g. transposed European legislation and national laws, regulations and administrative provisions). In order to meet the provisions of the Construction Products Directive, these requirements need also to be complied with, when and where they apply.

⁷ The technical documentation of this European technical approval is deposited at the Deutsches Institut für Bautechnik and, as far as relevant for the tasks of the approved bodies involved in the attestation of conformity procedure, is handed over to the approved bodies.

3 Evaluation and attestation of conformity and CE marking

3.1 System of attestation of conformity

According to the Decision 96/582/EG of the European Commission⁸ system 2(i) (referred to as System 1) of the attestation of conformity applies.

This system of attestation of conformity is defined as follows:

System 1: Certification of the conformity of the product by an approved certification body on the basis of:

- (a) Tasks for the manufacturer:
 - (1) factory production control;
 - (2) further testing of samples taken at the factory by the manufacturer in accordance with a prescribed control plan;
- (b) Tasks for the approved body:
 - (3) initial type-testing of the product;
 - (4) initial inspection of factory and of factory production control;
 - (5) continuous surveillance, assessment and approval of factory production control.

Note: Approved bodies are also referred to as "notified bodies".

3.2 Responsibilities

3.2.1 Tasks for the manufacturer

3.2.1.1 Factory production control

The manufacturer shall exercise permanent internal control of production. All the elements, requirements and provisions adopted by the manufacturer shall be documented in a systematic manner in the form of written policies and procedures, including records of results performed. This production control system shall insure that the product is in conformity with this European technical approval.

The manufacturer may only use initial/raw/constituent materials stated in the technical documentation of this European technical approval.

The factory production control shall be in accordance with the control plan which is part of the technical documentation of this European technical approval. The control plan is laid down in the context of the factory production control system operated by the manufacturer and deposited at Deutsches Institut für Bautechnik.⁹

The results of factory production control shall be recorded and evaluated in accordance with the provisions of the control plan.

3.2.1.2 Other tasks for the manufacturer

The manufacturer shall, on the basis of a contract, involve a body which is approved for the tasks referred to in section 3.1 in the field of anchors in order to undertake the actions laid down in section 3.2.2 For this purpose, the control plan referred to in sections 3.2.1.1 and 3.2.2 shall be handed over by the manufacturer to the approved body involved.

The manufacturer shall make a declaration of conformity, stating that the construction product is in conformity with the provisions of this European technical approval.

⁸ Official Journal of the European Communities L 254 of 08.10.1996

⁹ The control plan is a confidential part of the European technical approval and only handed over to the approved body involved in the procedure of attestation of conformity. See section 3.2.2.

3.2.2 Tasks for the approved bodies

The approved body shall perform the

- initial type-testing of the product,
- initial inspection of factory and of factory production control,
- continuous surveillance, assessment and approval of factory production control

in accordance with the provisions laid down in the control plan.

The approved body shall retain the essential points of its actions referred to above and state the results obtained and conclusions drawn in a written report.

The approved certification body involved by the manufacturer shall issue an EC certificate of conformity of the product stating the conformity with the provisions of this European technical approval.

In cases where the provisions of the European technical approval and its control plan are no longer fulfilled the certification body shall withdraw the certificate of conformity and inform Deutsches Institut für Bautechnik without delay.

3.3 CE marking

The CE marking shall be affixed on each packaging of the anchor. The letters "CE" shall be followed by the identification number of the approved certification body, where relevant, and be accompanied by the following additional information:

- the name and address of the holder of the approval (legal entity responsible for the manufacture),
- the last two digits of the year in which the CE marking was affixed,
- the number of the EC certificate of conformity for the product,
- the number of the European technical approval,
- the number of the guideline for European technical approval,
- use category (ETAG 001-1, Option 7)
- size.

4 Assumptions under which the fitness of the product for the intended use was favourably assessed

4.1 Manufacturing

The European technical approval is issued for the product on the basis of agreed data/information, deposited at Deutsches Institut für Bautechnik, which identifies the product that has been assessed and judged. Changes to the product or production process, which could result in this deposited data/information being incorrect, should be notified to Deutsches Institut für Bautechnik before the changes are introduced.

Deutsches Institut für Bautechnik will decide whether or not such changes affect the approval and consequently the validity of the CE marking on the basis of the approval and if so whether further assessment or alterations to the approval shall be necessary.

4.2 Design of anchorages

The fitness of the anchor for the intended use is given under the following conditions:

The anchorages are designed in accordance with the EOTA Technical Report TR 029 "Design of bonded anchors"¹⁰ under the responsibility of an engineer experienced in anchorages and concrete work.

Post-installed reinforcing bars may be used as anchor designed in accordance with the EOTA Technical Report TR 029. The basic assumptions for the design according to anchor theory shall be observed. This includes the consideration of tension and shear loads and the corresponding failure modes as well as the assumption that the base material (concrete structural element) remains essentially in the serviceability limit state (either non-cracked or cracked) when the connection is loaded to failure. Such applications are e.g. concrete overlay or shear dowel connections or the connections of a wall predominantly loaded by shear and compression forces with the foundation, where the rebars act as dowels to take up shear forces. Connections with reinforcing bars in concrete structures designed in accordance with EN 1992-1-1:2004 (e.g. connection of a wall loaded with tension forces in one layer of the reinforcement with the foundation) are not covered by this European technical approval.

Verifiable calculation notes and drawings are prepared taking account of the loads to be anchored.

The position of the anchor is indicated on the design drawings (e.g. position of the anchor relative to reinforcement or to supports, etc.).

4.3 Installation of anchors

The fitness for use of the anchor can only be assumed if the anchor is installed as follows:

- anchor installation carried out by appropriately qualified personnel and under the supervision of the person responsible for technical matters of the site,
- anchor installation in accordance with the manufacturer's specifications and drawings using the tools indicated in the technical documentation of this European technical approval,
- use of the anchor only as supplied by the manufacturer without exchanging the components,
- steel elements may be used if the following requirements are fulfilled:
 - material, dimensions and mechanical properties of the steel elements according to the specifications given in Annex 3, Table 1,
 - confirmation of material and mechanical properties of the metal parts by inspection certificate 3.1 according to EN 10204:2004, the documents should be stored,
 - marking of the steel element with the envisage embedment depth. This may be done by the manufacturer of the rod or the person on jobsite.
- embedded reinforcing bars shall comply with specifications given in Annex 4,
- checks before placing the anchor to ensure that the strength class of the concrete in which the anchor is to be placed is in the range given and is not lower than that of the concrete to which the characteristic loads apply,
- check of concrete being well compacted, e.g. without significant voids,
- marking and keeping the effective anchorage depth,
- edge distance and spacing not less than the specified values without minus tolerances,
- overhead installation only for $d_0 \leq 35$ mm and $h_0 \leq 210$ mm,

¹⁰ The Technical Report TR 029 "Design of Bonded Anchors" is published in English on EOTA website www.eota.eu.

- positioning of the drill holes without damaging the reinforcement,
- drilling by hammer-drilling only,
- in case of aborted drill hole: the drill hole shall be filled with mortar,
- the anchor must not be installed in water filled bore holes,
- cleaning the drill hole in accordance with Annexes 6,
- Keeping the effective anchorage depth,
- the temperature of the concrete shall be consistent with the specification given in Annex 7,
- observing the curing time according to Annex 7, Table 5 until the anchor may be loaded,
- An installation torque is not required for functioning of the anchor. However, the torque moments given in Annex 5 must not be exceeded.

5 Indications to the manufacturer

5.1 Responsibility of the manufacturer

The manufacturer is responsible to ensure that the information on the specific conditions according to 1 and 2 including Annexes referred to as well as sections 4.2, 4.3 and 5.2 is given to those who are concerned. This information may be made by reproduction of the respective parts of the European technical approval.

In addition all installation data shall be shown clearly on the package and/or on an enclosed instruction sheet, preferably using illustration(s).

The minimum data required are:

- drill bit diameter,
- hole depth,
- nominal diameter of steel elements,
- minimum effective anchorage depth,
- information on the installation procedure, including cleaning of the hole with the cleaning equipments, preferably by means of an illustration,
- anchor component installation temperature,
- ambient temperature of the concrete during installation of the anchor,
- admissible processing time of the mortar,
- curing time until the anchor may be loaded as a function of the ambient temperature in the concrete during installation,
- maximum torque moment,
- identification of the manufacturing batch.

All data shall be presented in a clear and explicit form.

5.2 Packaging, transport and storage

The cartridges shall be protected against sun radiation and shall be stored according to the manufacturer's installation instructions in dry condition at temperatures of at least +5 °C to not more than +25 °C.

Cartridges with expired shelf life must no longer be used.

Andreas Kummerow
p.p. Head of Department

beglaubigt:
Lange

Injection mortar "ChemMates VSF" and "ChemMates VSF-LT"

Coaxial cartridges 150 ml, 280 ml, 410 ml

sealing cap

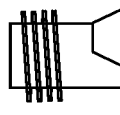
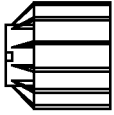

Imprint:
Trade name, size, processing notes, charge
code, storage life, hazard code, curing- and
processing time

Side-by-side cartridge 345 ml

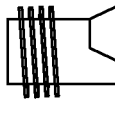
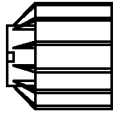

Imprint: see above

Static mixer

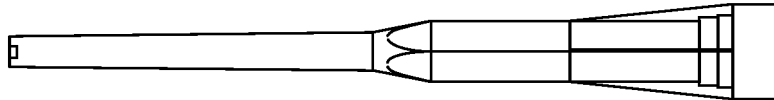

Piston Plug and Extension hose (for $h_{ef} > 240$ mm)

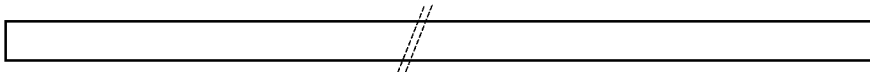
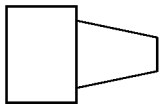

- Intended use:**
- Use in uncracked concrete only, strength class C20/25 to C50/60
 - Installation and service condition in dry or wet concrete
 - Overhead installation only for $d_0 \leq 35$ mm and $h_0 \leq 210$ mm
 - Threaded rods or deformed reinforcing bars according to Annexes 3 and 4
 - Use under static or quasi-static loading only
 - Temperature range -40°C to $+80^\circ\text{C}$ (max. short term temperature $+80^\circ\text{C}$ and max. long term temperature $+72^\circ\text{C}$)

ChemMates VSF

Product (injection mortar) and intended use

Annex 1

Anchor rod with washer and hexagon nut M8, M10, M12, M16, M20, M24, M27, M30

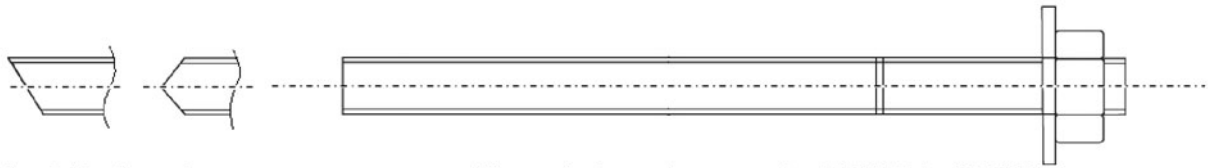

Installed anchor

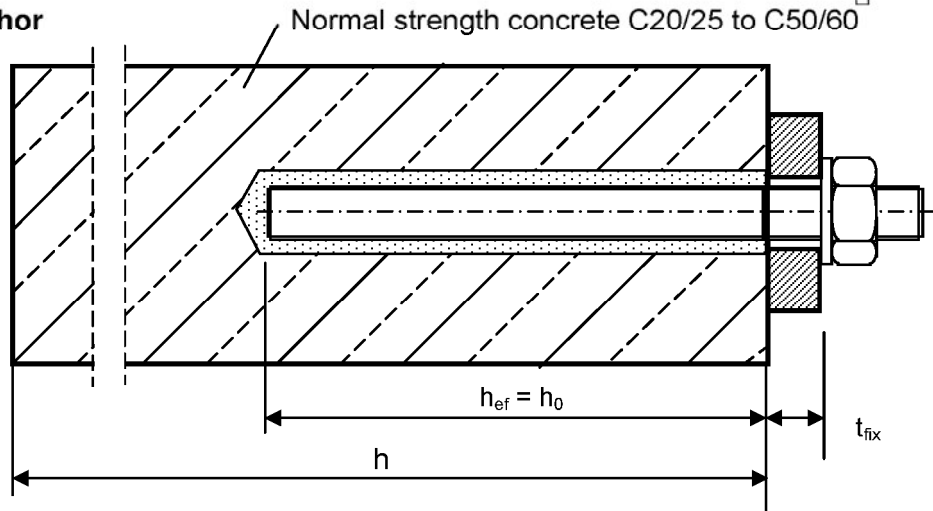

Reinforcing Bar $\varnothing 16, \varnothing 20, \varnothing 25, \varnothing 28, \varnothing 32$:



Installed anchor

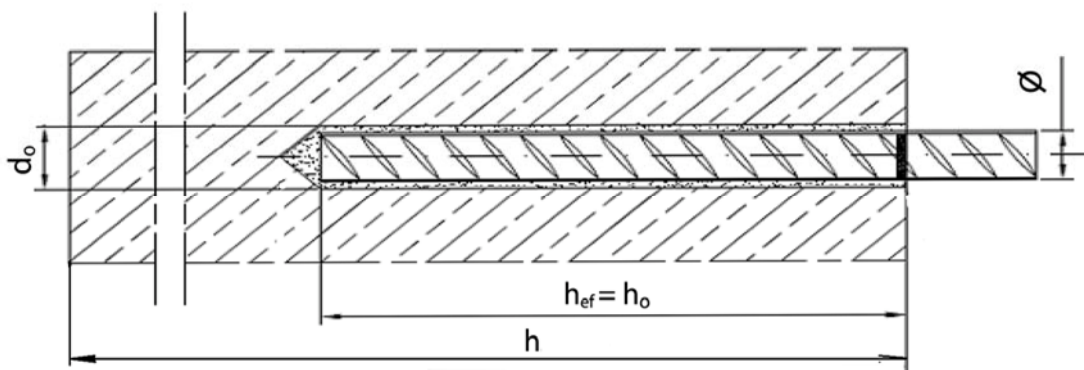

ChemMates VSF

Product (steel) and intended use

Annex 2

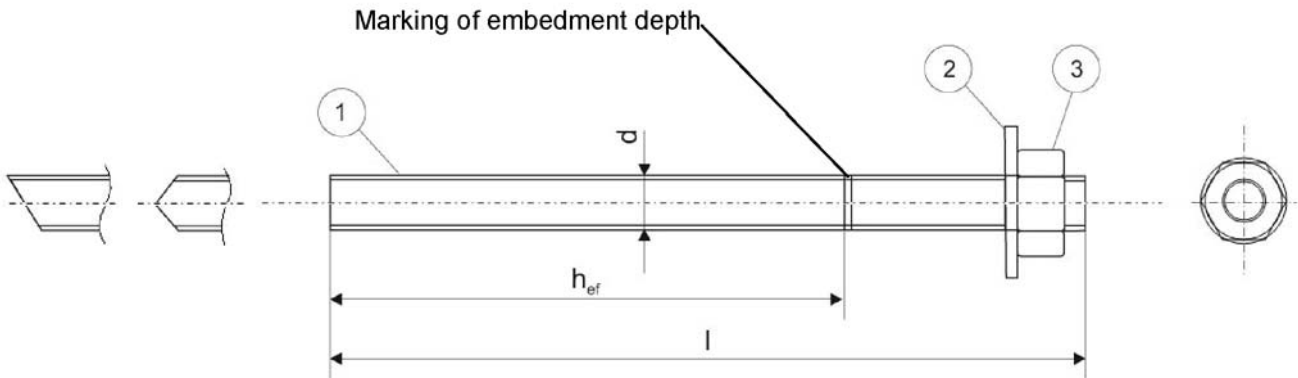

Commercial standard threaded rod M8, M10, M12, M16, M20, M24, M27 or M30 with

- Material and mechanical properties acc. to Table 1
- Confirmation of material and mechanical properties by inspection certificate 3.1 acc. to EN 10204:2004
- Marking of the threaded rod with embedment depth

Table 1 Designation and materials for Threaded rods

Part	Designation	Material
Steel elements made of zinc coated steel		
1	Threaded rod	Steel, galvanised $\geq 5 \mu\text{m}$ acc. to EN ISO 4042:1999 property class 5.8 or 8.8 acc. to EN ISO 898-1:1999
2	Washer EN ISO 887:2000, EN ISO 7089:2000, EN ISO 7094:2000	Steel, galvanised $\geq 5 \mu\text{m}$ acc. to EN ISO 4042:1999
3	Hexagon nut EN ISO 4032:2000	Steel, galvanised $\geq 5 \mu\text{m}$ acc. to EN ISO 4042:1999 property class 5 or 8 acc. to EN ISO 898-2:2012
Steel elements made of stainless steel		
1	Threaded rod	Stainless steel 1.4401, 1.4404 or 1.4571 property class 70 or 80 acc. to EN ISO 3506:1997
2	Washer EN ISO 887:2000, EN ISO 7089:2000, EN ISO 7094:2000	
3	Hexagon nut EN ISO 4032:2000	

ChemMates VSF

Specifications for Threaded rods, washers and hexagon nuts

Annex 3

Deformed Reinforcing bar $\varnothing 16, \varnothing 20, \varnothing 25, \varnothing 28$ or $\varnothing 32$

Marking of Embedment depth



Table 2 Designation and Materials for Reinforcing Bar

Product form		Bars and de-coiled rods	
Class		B	C
Characteristic yield strength f_{yk} or $f_{0,2k}$ (N/mm ²)		400 to 600	
Minimum value of $k = (f_t / f_y)_k$		$\geq 1,08$	$\geq 1,15$ < 1,35
Characteristic strain at maximum force ϵ_{uk} (%)		$\geq 5,0$	$\geq 7,5$
Bendability		Bend / Rebend test	
Maximum deviation from nominal mass (individual bar) %	Nominal bar size (mm)		
	≤ 8	$\pm 6,0$	
	> 8	$\pm 4,5$	
Bond: Minimum value of related rib area $f_{R,min}$	Nominal bar size (mm)		
	8 to 12	0,040	
	> 12	0,056	

Rib height of the bar shall be in the range $0,05 \cdot d \leq h \leq 0,07 \cdot d$.
(d: nominal diameter of the bar; h: Rib height of the bar).

Regarding design of post-installed rebar as anchor see chapter 4.2

ChemMates VSF

Specifications for Reinforcing bar

Annex 4

Table 3 Installation Parameter for Threaded Rods

Thread diameter		M 8	M 10	M 12	M 16	M 20	M 24	M 27	M 30
Nominal drill hole diameter	d_0 [mm] =	10	12	14	18	24	28	32	35
Embedment depth = depth of drill hole	$h_{ef,min}$ [mm] =	60	60	70	80	90	96	108	120
	Concrete Temperature > 0°C $h_{ef,max}$ [mm] =	160	200	240	320	400	480	540	600
	Concrete Temperature < 0°C $h_{ef,max}$ [mm] =	80	100	120	160	200	240	270	300
Diameter of clearance hole in the fixture	d_r [mm] ≤	9	12	14	18	22	26	30	33
Diameter of steel brush	d_b [mm] ≤	12	13,3	14,9	19,35	26	30	34	37
Torque moment	T_{inst} [Nm] ≤	10	20	40	80	120	160	180	200
Minimum thickness of member	h_{min} [mm]	$h_{ef} + 30 \text{ mm} \geq 100 \text{ mm}$			$h_{ef} + 2d_0$				
Minimum spacing	s_{min} [mm] =	0,5 h_{ef} ; ≥ 35 mm							
Minimum edge distance	c_{min} [mm] =								

Table 4 Installation Parameter for Reinforcing Bars

Diameter of reinforcing bar		Ø 16	Ø 20	Ø 25	Ø 28	Ø 32
Nominal drill hole diameter	d_0 [mm] =	20	25	30	35	40
Embedment depth = depth of drill hole	$h_{ef,min}$ [mm] =	80	90	100	112	128
	Concrete Temperature > 0°C $h_{ef,max}$ [mm] =	320	400	500	560	640
	Concrete Temperature < 0°C $h_{ef,max}$ [mm] =	160	200	250	280	300
Diameter of steel brush	d_b [mm] ≤	22	26	32	37	44
Minimum thickness of member	h_{min} [mm] =	$h_{ef} + 2d_0$				
Minimum spacing	s_{min} [mm] =	0,5 h_{ef}				
Minimum edge distance	c_{min} [mm] =	0,5 h_{ef}				



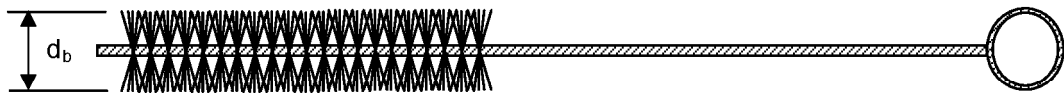







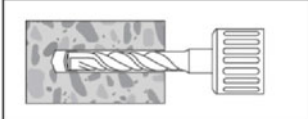

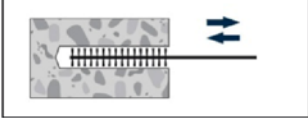
Steel brush

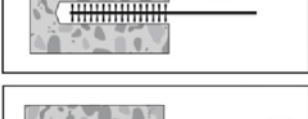

ChemMates VSF

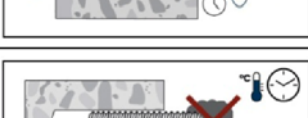
Installation parameter

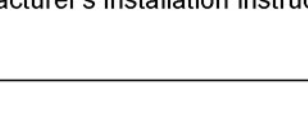
Annex 5

	<p>Drill the hole with the correct diameter and depth using a rotary percussive machine. Check the perpendicularity of the hole during the drilling operation. For concrete temperature $-20^{\circ}\text{C} < t < 0^{\circ}\text{C}$ the bore hole depth is limited to $h_0 \leq 10d$</p>
	<p>Clean the hole from drilling dust, core fragments, oil, water, grease and other contaminants prior to mortar injection with manual blower and standard manual brush. However if it is possible we recommend to blow using oil-free compressed air. Before brushing, clean the brush and check if the brush diameter is correct.</p>
	<p>The hole shall be cleaned by 2 blowing operations / 2 brushing operations / 2 blowing operations to the deepest hole depth. For bore hole depth > 240 mm use nozzle extension. The threaded rod and rebar should be free of dirt, grease, oil or other foreign material.</p>
	
	
	
	
	
	<p>For concrete temperature $-20^{\circ}\text{C} < t < 0^{\circ}\text{C}$ only mortar version ChemMates VSF LT may be used. Use appropriate static mixer and dispenser. Unscrew the front cup of the cartridge, screw the cartridge on the mixer and insert the cartridge in the gun.</p>
	<p>Before starting to use a new cartridge discard the first swings of the mortar until an homogeneous colour is achieved. For $h_{ef} > 240$ mm use of extension hoses and piston plugs is required</p>
	<p>Inject the mortar starting from the bottom of the hole. In order to avoid entrapment of the air, remove the mixer slowly bit by bit during pressing-out. Filling the drill hole with a quantity of the injection mortar corresponding to 2/3 of the drill hole depth.</p>
	<p>Insert immediately the steel element up to the embedment mark, slowly and with a slight twisting motion, the gap must be completely filled with mortar. Remove excess of injection mortar around the steel element.</p>
	<p>Don't touch the steel element until the curing time has passed.</p>

ChemMates VSF

Manufacturer's installation instructions

Annex 6

Table 5 Maximum processing time and minimum curing time

ChemMates VSF-LT			ChemMates VSF		
Concrete Temperature	Maximum processing time	Minimum curing time in dry concrete	Concrete temperature	Maximum processing time	Minimum curing time in dry concrete
[°C]	[minutes]	[hours]	[°C]	[minutes]	[hours]
-20	60	24h			
-15	40	12h			
-10	25	8h			
-5	16	4h			
0	11	3h			
0	11	3h	0	45	12h
5	7	2h	5	30	8h
10	5	1h30'	10	20	5h
15	3	1h15'	15	12	3h
20	2	1h	20	7	2h
			25	4	1h30'
			30	3	1h15'
			35	2	1h

If the anchor is set in wet concrete, the curing time shall be doubled

ChemMates VSF

Maximum processing time and minimum curing time

Annex 7

**Table 6 Threaded rods according to Annex 3,
Design method A, Characteristic values for tension load**

Thread size			M 8	M 10	M 12	M 16	M 20	M 24	M 27	M 30
Steel failure										
Characteristic resistance	$N_{Rk,s}$	[kN]	$A_s \times f_{uk}^{5)}$							
Partial safety factor	$\gamma_{Ms,N}^{1)}$	[-]	See TR 029 Section 3.2.2.2 ⁵⁾							
Combined pullout and concrete cone failure										
ChemMates VSF and ChemMates VSF-LT: Temperature of concrete at installation and curing > 0 °C										
Characteristic bond resistance in non-cracked concrete C20/25	$\tau_{Rk,uncr}$	[N/mm ²]	11	10	10	9	8,5	7	7	7
Only ChemMates VSF-LT for Temperature of concrete at installation and curing > -20 °C										
Characteristic bond resistance in non-cracked concrete C20/25	$\tau_{Rk,uncr}$	[N/mm ²]	9	8,5	8,5	7,5	7	6	6	6
Partial safety factor	$\gamma_{Mc} = \gamma_{Mp}^{1)}$		1,5 ²⁾				1,8 ³⁾	2,1 ⁴⁾		
Increasing factors for non-cracked concrete Ψ_c	C30/37		1,04							
	C40/50		1,08							
	C50/60		1,10							
Splitting failure										
Edge distance	$C_{cr,sp}$	[mm]	$1,0 h_{ef} \leq 2 h_{ef} (2,5 - h/h_{ef}) \leq 2,4 h_{ef}$							
Spacing	$S_{cr,sp}$	[mm]	$2 C_{cr,sp}$							
Partial safety factor	$\gamma_{Msp}^{1)}$		1,5 ²⁾				1,8 ³⁾	2,1 ⁴⁾		

- 1) In absence of other national regulations
 2) The installation safety factor $\gamma_2 = 1,0$ is included
 3) The installation safety factor $\gamma_2 = 1,2$ is included
 4) The installation safety factor $\gamma_2 = 1,4$ is included
 5) The values f_{uk} and f_{yk} are given in the Technical Specification for the relevant material

Table 7 Displacements for threaded rods under tension load

Thread size			M 8	M 10	M 12	M 16	M 20	M 24	M 27	M 30
Displacement	δ_{N0}	[mm/(N/mm ²)]	0,39	0,33	0,32	0,33	0,36	0,32	0,52	0,41
Displacement	δ_{Noc}	[mm/(N/mm ²)]	0,78	0,66	0,64	0,66	0,72	0,64	1,04	0,82

ChemMates VSF

Threaded rods
Design method A, Characteristic values for tension load,
Displacements

Annex 8

**Table 8 Reinforcing bars acc. to Annex 4,
Design method A, Characteristic values for tension load**

Nominal diameter		Ø 16	Ø 20	Ø 25	Ø 28	Ø 32	
Steel failure							
Characteristic resistance	$N_{Rk,s}$	[kN]	$A_s \times f_{uk}^{5)}$				
Partial safety factor	$\gamma_{Ms,N}^{1)}$	[-]	See TR 029 Section 3.2.2.2 ⁵⁾				
Combined pullout and concrete cone failure							
ChemMates VSF and ChemMates VSF-LT: Temperature of concrete at installation and curing > 0 °C							
Characteristic bond resistance in non-cracked concrete C20/25	$\tau_{Rk,uncr}$	[N/mm ²]	9	8,5	7	7	6,5
Only ChemMates VSF-LT for Temperature of concrete at installation and curing > -20 °C							
Characteristic bond resistance in non-cracked concrete C20/25	$\tau_{Rk,uncr}$	[N/mm ²]	7,5	7	6	6	5,5
Partial safety factor	$\gamma_{Mc} = \gamma_{Mp}^{1)}$		1,5 ²⁾	1,8 ³⁾	2,1 ⁴⁾		
Increasing factors for non-cracked concrete Ψ_c	C30/37		1,04				
	C40/50		1,08				
	C50/60		1,10				
Splitting failure							
Edge distance	$C_{cr,sp}$	[mm]	$1,0 h_{ef} \leq 2 h_{ef} (2,5 - h/h_{ef}) \leq 2,4 h_{ef}$				
Spacing	$S_{cr,sp}$	[mm]	$2 C_{cr,sp}$				
Partial safety factor	$\gamma_{Msp}^{1)}$		1,5 ²⁾	1,8 ³⁾	2,1 ⁴⁾		

- 1) In absence of other national regulations
 2) The partial safety factor $\gamma_2 = 1,0$ is included
 3) The partial safety factor $\gamma_2 = 1,2$ is included
 4) The partial safety factor $\gamma_2 = 1,4$ is included
 5) The values f_{uk} and f_{yk} are given in the Technical Specification for the relevant material

Table 9 Displacements for reinforcing bars under tension load

Nominal diameter		Ø 16	Ø 20	Ø 25	Ø 28	Ø 32	
Displacement	δ_{NO}	[mm/(N/mm ²)]	0,33	0,36	0,32	0,52	0,41
Displacement	δ_{Noc}	[mm/(N/mm ²)]	0,66	0,72	0,64	1,04	0,82

ChemMates VSF

Reinforcing bars
Design method A, Characteristic values for tension load,
Displacements

Annex 9

**Table 10 Threaded rods according to Annex 3,
Reinforcing bars acc. to Annex 4,
Design method A, Characteristic values for shear load**

Thread size			M 8	M 10	M 12	M 16	M 20	M 24	M 27	M 30
Diameter of reinforcing bar						Ø16	Ø20	Ø25	Ø28	Ø32
Steel failure										
Characteristic resistance	$V_{Rk,s}$	[kN]	$0,5 \times A_s \times f_{uk}^{3)}$							
Characteristic bending moment	$M_{Rk,s}^0$	[Nm]	$1,2 \times W_{el} \times f_{uk}^{3)}$							
Partial safety factor	$\gamma_{Ms}^{1)}$	[-]	See TR 029 Section 3.2.2.2							
Concrete pry-out failure										
Factor k in section 5.2.3.3 of TR 029	k	[-]	2,0							
Partial safety factor	$\gamma_{Mc}^{1)}$	[-]	See TR 029 Section 3.2.2.1							
Concrete edge failure										
Characteristic resistance	$V_{Rk,c}$	[kN]	See TR 029 Section 5.2.3.4							
Partial safety factor	$\gamma_{Mc}^{1)}$	[-]	See TR 029 Section 3.2.2.1							

1) In absence of other national regulations

2) The installation safety factor for shear load is $\gamma_2 = 1,0$

3) The values f_{uk} and f_{yk} are given in the Technical Specification for the relevant material,

Table 11 Displacements for threaded rods under shear load

Diameter of threaded rod			M 8	M 10	M 12	M 16	M 20	M 24	M 27	M 30
Displacement	δ_{v0}	[mm/(kN)]	1,0							
Displacement	$\delta_{v\infty}$	[mm/(kN)]	1,5							

Table 12 Displacements for reinforcing bars under shear load

Diameter of reinforcing bar			Ø 16	Ø 20	Ø 25	Ø 28	Ø 32
Displacement	δ_{v0}	[mm/(N/mm ²)]	1,0				
Displacement	$\delta_{v\infty}$	[mm/(N/mm ²)]	1,5				

ChemMates VSF

Threaded rods and reinforcing bars
Design method A, Characteristic values for shear loads,
Displacements

Annex 10