

Approval body for construction products
and types of construction

Bautechnisches Prüfamt

An institution established by the Federal and
Laender Governments



European Technical Assessment

ETA-13/1067
of 15 January 2014

General Part

Technical Assessment Body issuing the
European Technical Assessment:

Deutsches Institut für Bautechnik

Trade name of the construction product

BeA Bardafix cladding brackets

Product family
to which the construction product belongs

Angle brackets for use in timber constructions

Manufacturer

Joh. Friedrich Behrens AG
Bogenstraße 43-45
22926 Ahrensburg
DEUTSCHLAND

Manufacturing plant

BeA Plant 20

This European Technical Assessment
contains

16 pages including 3 annexes which form an integral part
of this assessment

This European Technical Assessment is
issued in accordance with Regulation (EU)
No 305/2011, on the basis of

Guideline for European technical approval "Three-
dimensional nailing plates", ETAG 015,
used as European Assessment Document (EAD)
according to Article 66 Paragraph 3 of Regulation (EU)
No 305/2011.

The European Technical Assessment is issued by the Technical Assessment Body in its official language. Translations of this European Technical Assessment in other languages shall fully correspond to the original issued document and shall be identified as such.

Communication of this European Technical Assessment, including transmission by electronic means, shall be in full. However, partial reproduction may only be made with the written consent of the issuing Technical Assessment Body. Any partial reproduction has to be identified as such.

This European Technical Assessment may be withdrawn by the issuing Technical Assessment Body, in particular pursuant to information by the Commission according to Article 25 Paragraph 3 of Regulation (EU) No 305/2011.

Specific part

1 Technical description of the product

BeA Bardafix cladding brackets are one-piece non-welded, face-fixed cladding brackets to be used in timber to concrete or timber to steel connections. They are connected to construction members made of timber or wood-based products according to Annex 2 with self-tapping screws according to EN 14592¹ or ETA, to steel members with screws according to EN 15048-1² or to concrete members with metal anchors according to ETA.

They are made by cold forming from carbon or stainless steel sheets according to Annex 1. Form, dimensions, hole positions and a typical installation are given in Annex 1.

2 Specification of the intended use in accordance with the applicable European assessment Document

The performances given in Section 3 are only valid if the cladding bracket is used in compliance with the specifications and conditions given in the Annexes 1 to 3.

The provisions made in this European technical assessment are based on an assumed working life of the cladding bracket of 50 years, provided that the brackets are subject to appropriate use and maintenance. The indications given on the working life cannot be interpreted as a guarantee given by the producer, but are to be regarded only as a means for choosing the right products in relation to the expected economically reasonable working life of the works.

3 Performance of the product and references to the methods used for its assessment

3.1 Mechanical resistance and stability (BWR 1)

Essential characteristic	Performance
Load-carrying capacities	See Annex 3
Stiffness	See Annex 3
Ductility in cyclic testing	No performance determined

¹ EN 14592:2008+A1:2012

² EN 15048-1:2007

Timber structures – Dowel-type fasteners – Requirements

Non-preloaded structural bolting assemblies – Part 1: General requirements

3.2 Safety in case of fire (BWR 2)

Essential characteristic	Performance
Reaction to fire	Cladding brackets are made from steel classified as Euroclass A1 in accordance with EC decision 96/603/EC, amended by EC Decision 2000/605/EC.
Resistance to fire	No performance determined (NPD) Performance in relation to fire resistance would be determined for the complete structural element with any associated finishes, however not for a single connector.

3.3 Hygiene, health and the environment (BWR 3)

The product does not contain/ release dangerous substances specified in TR 034.

Regarding dangerous substances contained in this European technical assessment, there may be requirements applicable to the products falling within its scope (e.g. transposed European legislation and national laws, regulations and administrative provisions). In order to meet the provisions of the Regulation (EU) No 305/2011, these requirements need also to be complied with, when and where they apply.

3.4 Safety and accessibility (BWR 4)

Not applicable

3.5 Protection against noise (BWR 5)

Not applicable

3.6 Energy economy and heat retention (BWR 6)

Not applicable

3.7 Sustainable use of natural resources (BWR 7)

For the sustainable use of natural resources no performance was investigated for this product.

3.8 General aspects

The verification of durability is part of testing the essential characteristics. Durability and serviceability is only ensured if the specifications of intended use according to Annex 1 to 3 are taken into account.

4 Assessment and verification of constancy of performance (AVCP) system applied, with reference to its legal base

According to Decision 97/638/EC of the Commission of 19 September 1997 (Official Journal of the European Communities L 268/36 of 1/10/1997) the system of assessment and verification of constancy of performance (see Annex V and Article 65 Paragraph 2 to Regulation (EU) No 305/2011) given in the following table applies.

Product	Intended use	Level or class	System
Three-dimensional nailing plates (with fasteners specified)	For structural timber products	Reaction to fire class and resistance to fire classes according to EN 13501-2	2+

5 Technical details necessary for the implementation of the AVCP system, as provided for in the applicable EAD

Technical details necessary for the implementation of the AVCP system are laid down in the control plan deposited at Deutsches Institut für Bautechnik.

Issued in Berlin on 15 January 2014 by Deutsches Institut für Bautechnik

Gerhard Breitschaft
President

beglaubigt:
Dewitt

Annex 1 Product details and definitions

Table 1.1 Material specification of the cladding brackets

Thickness (mm)	Steel designation	Steel number	Steel specification	Additional requirements	Tolerances according to	Coating specification
2.5	S 350 GD + Z 275	1.0529	EN 10346 ¹	-	EN 10143 ²	Z 275
	X5CrNi18-10	1.4301	EN 10088-4 ³	In cold-worked state: $R_{p0.2} \geq 350 \text{ N/mm}^2$ $R_m \geq 420 \text{ N/mm}^2$ $A_5 \geq 30 \%$	EN 10088-4	-

Table 1.2 Range of sizes

Bracket type	Height (mm)		Width (mm)		Depth (mm)	
	min	max	min	max	min	max
50x80	80	83	59	61	52	53
50x100	100	103	59	61	52	53
50x120	120	123	59	61	52	53
50x140	140	143	59	61	52	53
50x160	160	163	59	61	52	53
50x180	180	183	59	61	52	53
50x200	200	203	59	61	52	53
50x220	220	223	59	61	52	53
50x240	240	243	59	61	52	53
50x260	260	263	59	61	52	53
50x280	280	283	59	61	52	53
50x300	300	303	59	61	52	53

¹ EN 10346:2009

Continuously hot-dip coated steel flat products – Technical delivery conditions

² EN 10143:2006

Continuously hot-dip coated steel sheet and strip – Tolerances on dimensions and shape

³ EN 10088-4:2009

Stainless steels – Part 4: Technical delivery conditions for sheet/plate and strip of corrosion resisting steels for construction purposes

BeA Bardafix cladding brackets

Material specification and dimensions

Annex 1.1

Table 1.3 Fastener types and sizes

SCREW outer thread diameter (connection to wood members)	Minimum Length	Fastener specification
5.0	40	Self-tapping screws according to EN 14592 or ETA with a minimum <ul style="list-style-type: none"> – thread length of 24 mm, – characteristic withdrawal parameter of $f_{ax,k} = 9.8 \text{ N/mm}^2$ based on a characteristic density of the wood-based member of 350 kg/m^3, – characteristic torsional strength of $f_{tor,k} = 7.5 \text{ Nm}$.
SCREW nominal diameter (connection to steel members)	Length	
8.0	According to specification	Screws according to EN 15048-1
METAL ANCHOR nominal diameter (connection to concrete members)	Length	
8.0	According to specification	Metal anchors according to ETA

The fasteners shall be made from carbon or stainless steel. To avoid contact corrosion cladding brackets made from carbon steel shall be used with fasteners made from carbon steel and cladding brackets made from stainless steel shall be used with fasteners made from stainless steel.

BeA Bardafix cladding brackets

Fasteners

Annex 1.2

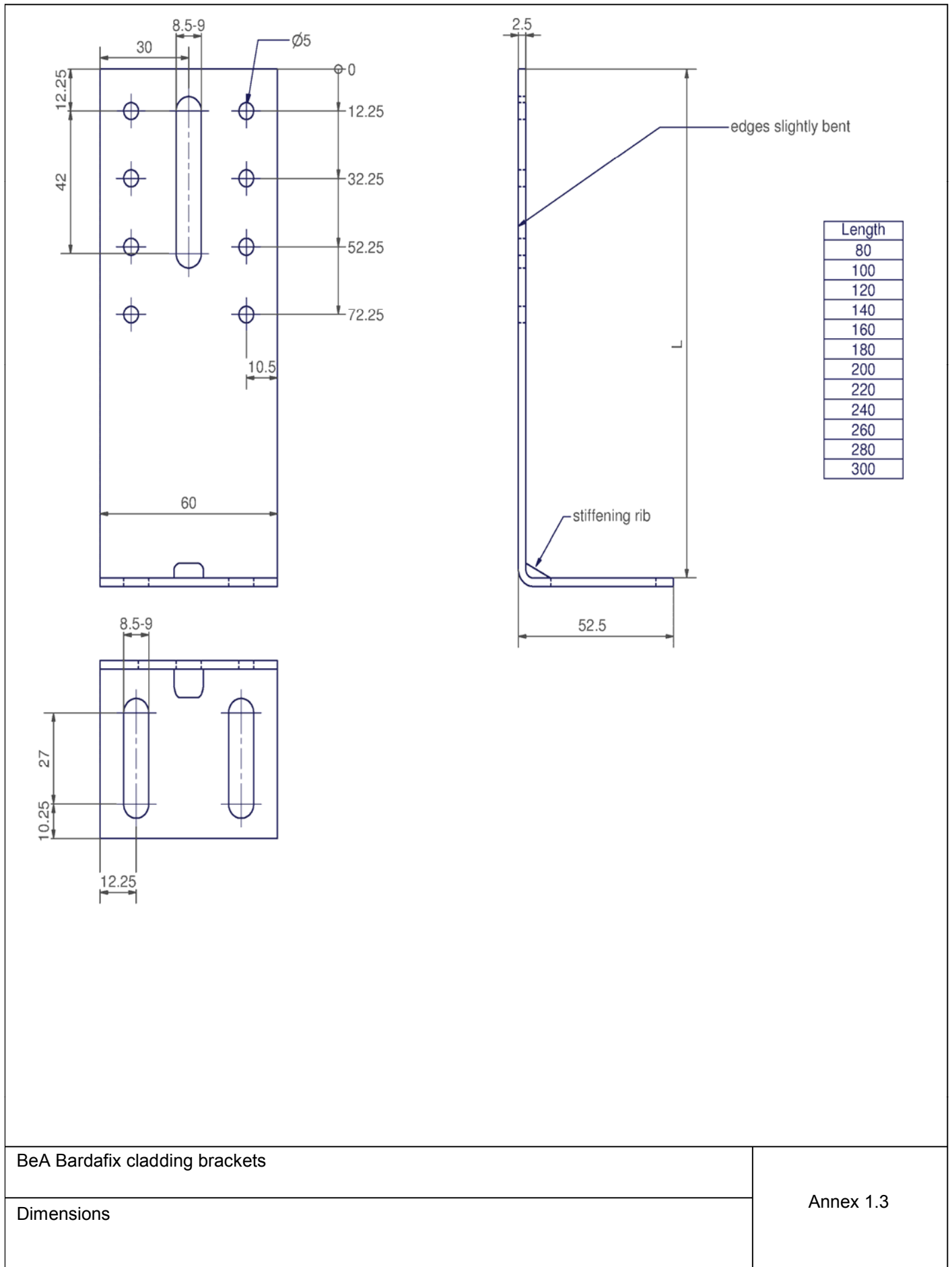

BeA Bardafix cladding brackets

Dimensions

Annex 1.3

English translation prepared by DIBt

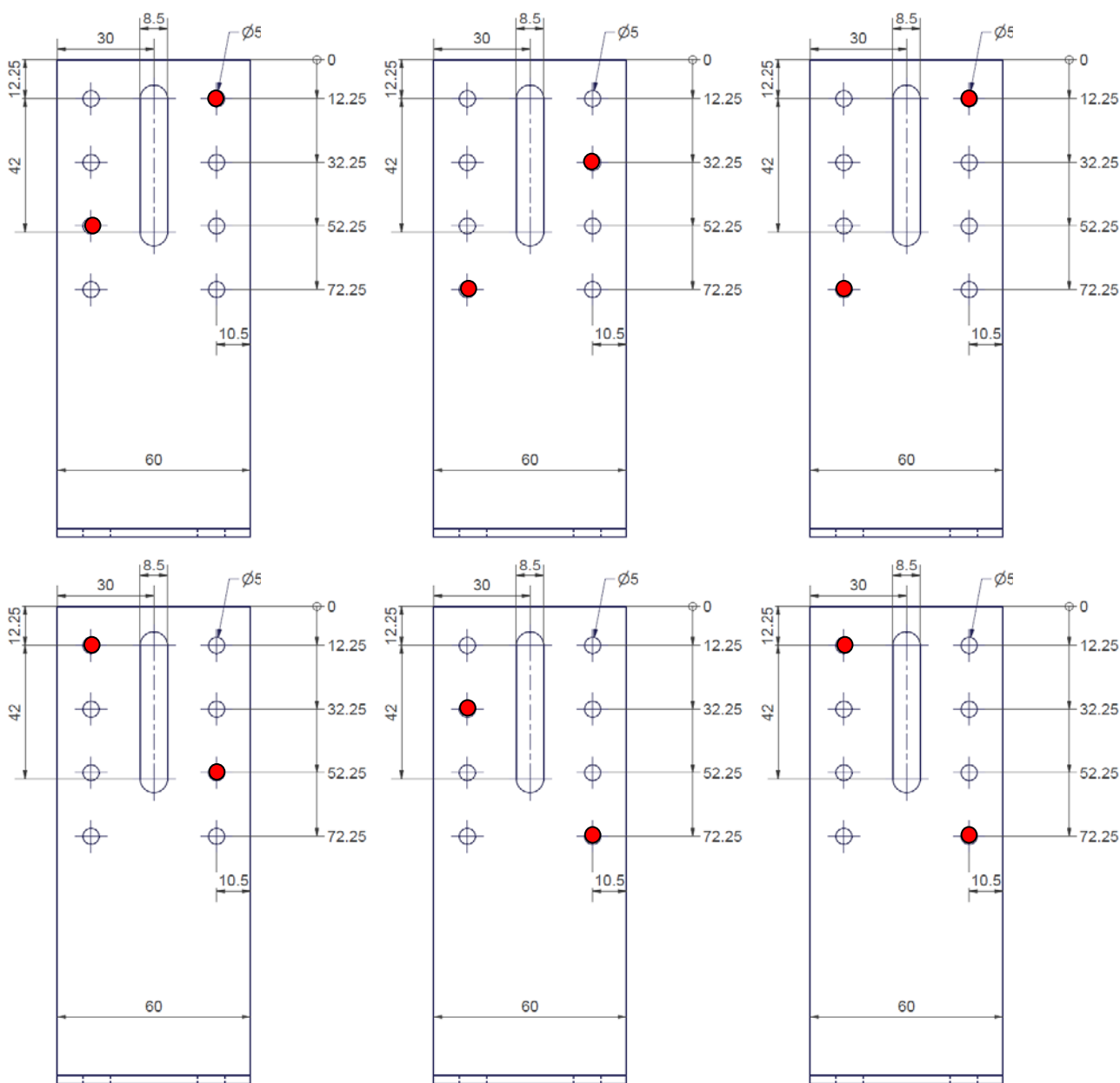

Electronic copy of the ETA by DIBt: ETA-13/1067

BeA Bardafix cladding brackets

Possible screw patterns for two screws per cladding bracket

Annex 1.4

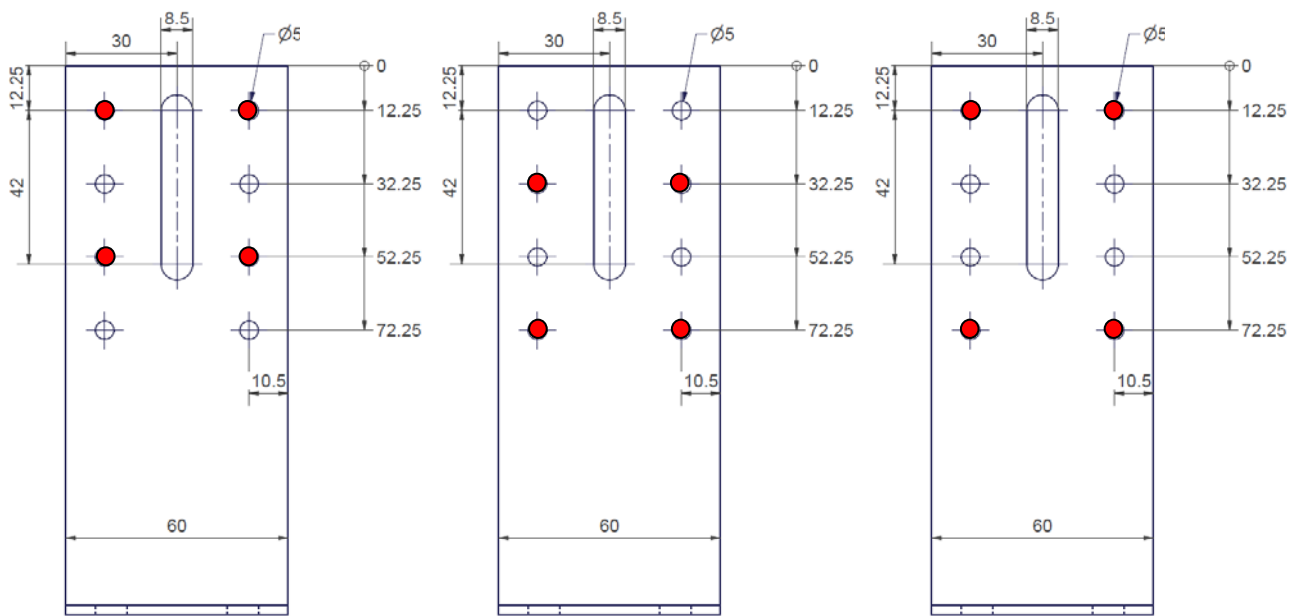

BeA Bardafix cladding brackets

Possible screw patterns for four screws per cladding bracket

Annex 1.5

Annex 2 Specifications of intended use

Cladding brackets subject to:

- Static and quasi-static loads

Base materials

The cladding brackets are used for connections in load bearing timber structures between wood members and concrete or steel members. The cladding brackets may be used for connecting the following wood members:

- Solid timber (softwood) of strength classes C14 – C40 according to EN 338¹/ EN 14081-1²,
- Glued laminated timber (softwood) according to EN 1194³/ EN 14080⁴,
- Laminated veneer lumber LVL according to EN 14374⁵, arrangement of the screws only perpendicular to the plane of the veneers
- Glued solid timber (softwood) according to EN 14080 or national provisions that apply at the installation site

The characteristic density of the wood members shall be from 290 kg/m³ to 420 kg/m³.

Regarding concrete and steel members the provisions in the respective ETA of the anchor or in the respective national technical building regulations shall be considered.

Use conditions (Environmental conditions)

The corrosion protection of the cladding brackets is given in Annex 1. Regarding use and environmental conditions national provisions at the building site shall apply. It shall be ensured that the screws and anchors, used to connect the cladding brackets, have a sufficient corrosion protection according to the national provisions at the building site.

1	EN 338:2009	Timber structures - Strength classes
2	EN 14081-1:2005	Timber structures - Strength graded structural timber with rectangular cross section - Part 1: General requirements
3	EN 1194:1999	Timber structures - Glued laminated timber - Strength classes and determination of characteristic values
4	EN 14080:2013	Timber structures - Glued laminated timber - Requirements
5	EN 14374:2004	Timber structures - Structural laminated veneer lumber - Requirements

BeA Bardafix cladding brackets	Annex 2.1
Specifications of intended use	

ANNEX 3 Characteristic values of the load-carrying capacities, stiffness, installation and design of the BeA Bardafix cladding brackets

Table 3.1 Characteristic load-carrying capacities load direction F_1 for one cladding bracket



All cladding brackets	$F_{1,Rk}$ [N] two screws per bracket	$F_{1,Rk}$ [N] four screws per bracket	
$L = 80 \text{ mm to } 300 \text{ mm}$	900	1800	

Table 3.2 Characteristic load-carrying capacities load direction F_{23} for one cladding bracket

Cladding bracket	$F_{23,Rk}$ [N] two screws per bracket	$F_{23,Rk}$ [N] four screws per bracket	
50 x 80	1020	2030	
50 x 100	860	1720	
50 x 120	720	1450	
50 x 140	600	1200	
50 x 160	490	990	
50 x 180	400	800	
50 x 200	330	650	
50 x 220	260	530	
50 x 240	220	440	
50 x 260	190	380	
50 x 280	180	360	
50 x 300	180	360	

The load-carrying capacities of two cladding brackets per connection are the double value of the characteristic values given in Table 3.1 and Table 3.2.

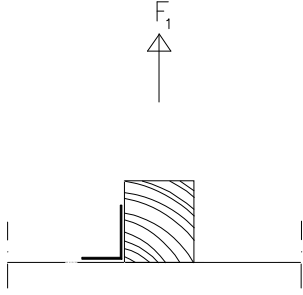
Table 3.1 and Table 3.2 state the load-carrying capacities of the cladding bracket connections for a characteristic density of 350 kg/m^3 . For wood based material with a lower characteristic density than 350 kg/m^3 the load-carrying capacities shall be reduced by the k_{dens} factor:

$$k_{\text{dens}} = \left(\frac{\rho_k}{350} \right)^{0.8} \quad (3.1)$$

Where ρ_k is the characteristic density of the wood based material in kg/m^3 , $290 \text{ kg/m}^3 \leq \rho_k < 350 \text{ kg/m}^3$.

BeA Bardafix cladding brackets	Annex 3.1
Characteristic values of the load-carrying capacities	

Definition of forces - Single cladding bracket per connection

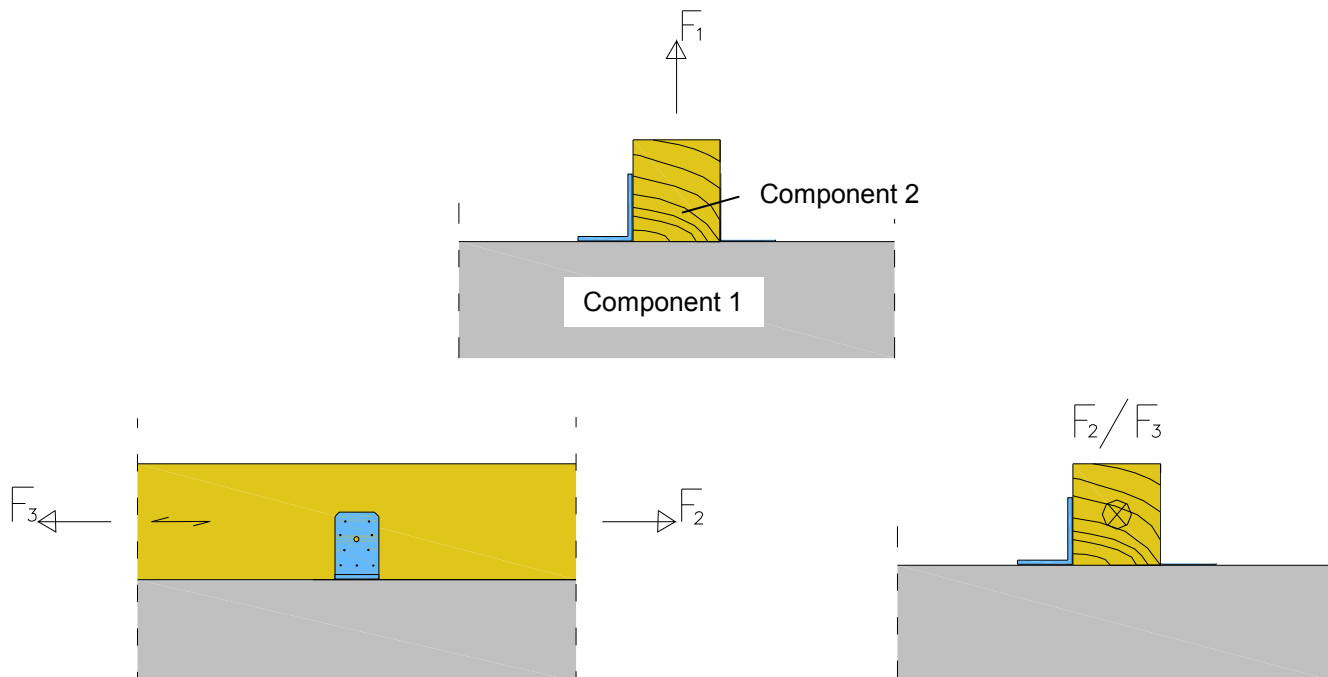

Figure 3.1 Single cladding bracket per connection

Acting forces

- F_1 Lifting force acting in the central axis of the cladding bracket. Component 2 shall be prevented from rotation.
- F_2 and F_3 Lateral force acting in the joint between the component 2 and the component 1 in the component 2 direction. Component 2 shall be prevented from rotation.

BeA Bardafix cladding brackets	Annex 3.2
Definition of forces	

Definition of forces - Two cladding brackets per connection

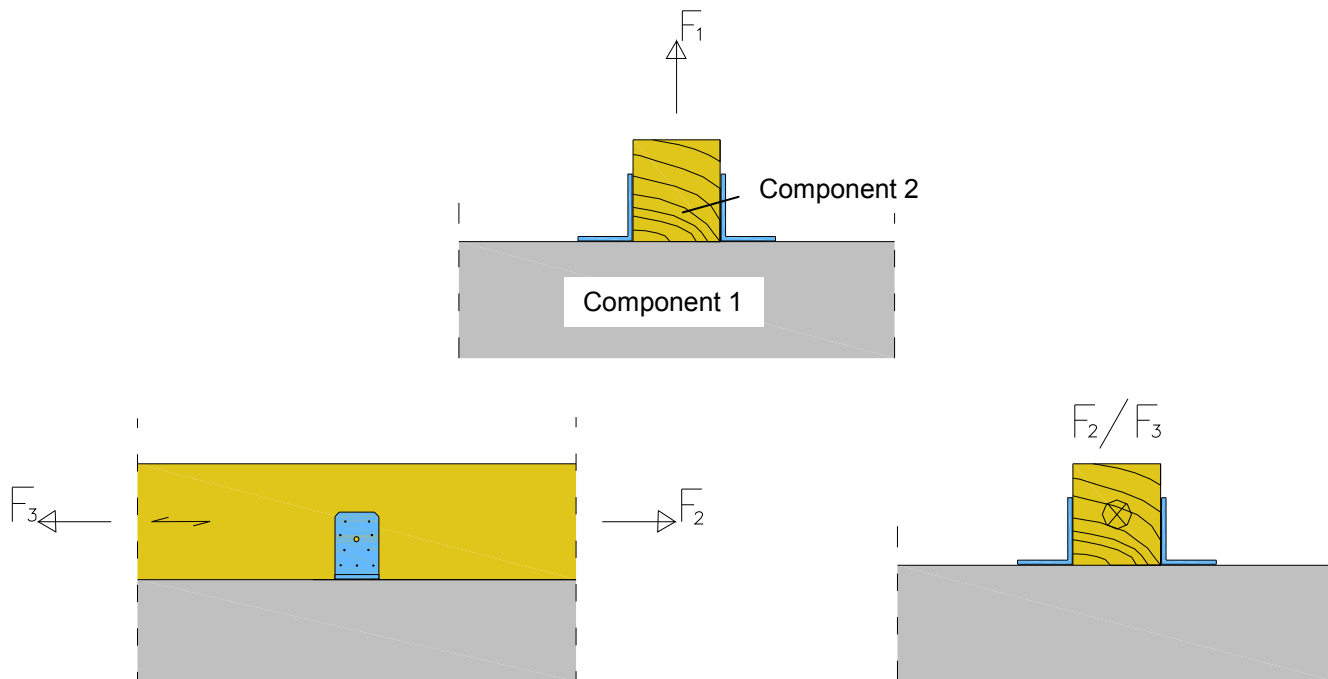

Figure 3.2 Two cladding brackets per connection

The angle brackets must be placed symmetrically to the component 2 axis.

Acting forces

F_1 Lifting force acting along the central axis of the joint

F_2 and F_3 Lateral force acting in the joint between the component 2 and component 1 in the component 2 direction

Slip moduli - 1 cladding bracket per connection

Load direction F_1 with 2 screws per cladding bracket:

$$K_{1,ser} = 300 - 0.4 \cdot L \quad \text{N/mm} \tag{3.2}$$

Load direction F_1 with 4 screws per cladding bracket:

$$K_{1,ser} = 600 - 0.8 \cdot L \quad \text{N/mm} \tag{3.3}$$

Load direction F_{23} with 2 screws per cladding bracket:

$$K_{23,ser} = \frac{2.8 \cdot 10^6}{L^2} \quad \text{N/mm} \tag{3.4}$$

Load direction F_{23} with 4 screws per cladding bracket:

$$K_{23,ser} = \frac{5.5 \cdot 10^6}{L^2} \quad \text{N/mm} \tag{3.5}$$

Where L is the bracket length in mm (see Annex 1.3).

Electronic copy of the ETA by DIBt: ETA-13/1067

BeA Bardafix cladding brackets	Annex 3.3
Definition of forces and Stiffness of the connection	

The slip moduli of two cladding brackets per connection are the double value of the slip moduli given in equation (3.2) to (3.5).

Installation

The connection may be with a single cladding bracket or with a cladding bracket on each side of the fastened timber member. The screw patterns given in Annex 1.4 and 1.5 shall be complied with.

The wood members shall have a thickness which is larger than the penetration depth of the screws into the members. The cladding brackets shall fit closely to the surface of the wood, concrete or steel member without any intermediate layer.

For single cladding brackets the wood member (component 2 according to figure 3.1) shall be prevented from rotation.

Fastener specification

See Annex 1.3, Table 1.3

For the screws the minimum edge spacings given in EN 1995-1-1:2004+A1:2008 as for nails in non-predrilled holes or in the ETA shall be kept.

Two different screw patterns are specified, where there are screws in two or four specified screw holes in the cladding bracket (see Annex 1). The screws shall be inserted without pre-drilling of the timber members.

The provisions in the ETA of the metal anchor shall be considered.

For screws connecting steel members the provisions in EN 1993-1-8 in combination with the respective national annex shall be considered.

Wane

Wane is not allowed, the timber has to be sharp-edged in the area of the cladding brackets.

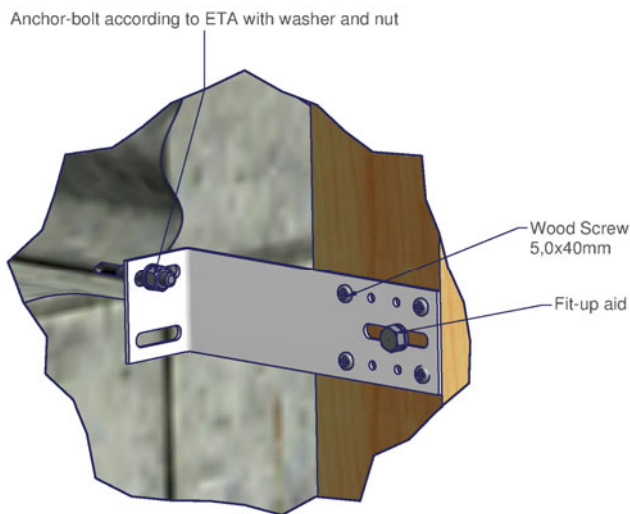

Figure 3.3 Installation example

BeA Bardafix cladding brackets	Annex 3.4
Installation	

Design

The design of the cladding brackets connections shall be in accordance with EN 1995-1-1⁶ in combination with the respective national annex or a similar national Timber Code as well as in accordance with the specification of the fasteners. The design value of the load-carrying capacity shall be calculated as the design value for timber failure.

The connection of the cladding bracket to concrete or steel members has to be verified. The verification of the connection is not subject of this European technical assessment.

Timber splitting

For the lifting force F_1 it must be checked in accordance with EN 1995-1-1 in combination with the respective national annex or a similar national Timber Code that splitting will not occur in the timber member.

Combined forces

If the forces F_1 and F_2/F_3 act at the same time, the following inequality shall be fulfilled:

$$\left(\frac{F_{1,Ed}}{F_{1,Rd}}\right)^2 + \left(\frac{F_{23,Ed}}{F_{23,Rd}}\right)^2 \leq 1 \tag{3.6}$$

⁶ EN 1995-1-1:2004+A1:2008 Eurocode 5: Design of timber structures – Part 1-1: General – Common rules and rules for buildings

BeA Bardafix cladding brackets	Annex 3.5
Design	