

Approval body for construction products  
and types of construction

Bautechnisches Prüfamt

An institution established by the Federal and  
Laender Governments



## European Technical Assessment

**ETA-14/0061**  
**of 11 April 2014**

### General Part

Technical Assessment Body issuing the  
European Technical Assessment:

Deutsches Institut für Bautechnik

Trade name of the construction product

TEKAFIKS VE PLUS, TEKAFIKS VE PLUS WINTER

Product family  
to which the construction product belongs

Bonded anchor for use in non-cracked concrete

Manufacturer

TKK d.o.o.  
Srpenica 1  
5224 SRPENICA  
SLOWENIEN

Manufacturing plant

Plant 1

This European Technical Assessment  
contains

14 pages including 3 annexes which form an integral part  
of this assessment

This European Technical Assessment is  
issued in accordance with Regulation (EU)  
No 305/2011, on the basis of

Guideline for European technical approval of "Metal  
anchors for use in concrete", ETAG 001 Part 5: "Bonded  
anchors", April 2013,  
used as European Assessment Document (EAD)  
according to Article 66 Paragraph 3 of Regulation (EU)  
No 305/2011.

The European Technical Assessment is issued by the Technical Assessment Body in its official language. Translations of this European Technical Assessment in other languages shall fully correspond to the original issued document and shall be identified as such.

Communication of this European Technical Assessment, including transmission by electronic means, shall be in full. However, partial reproduction may only be made with the written consent of the issuing Technical Assessment Body. Any partial reproduction has to be identified as such.

This European Technical Assessment may be withdrawn by the issuing Technical Assessment Body, in particular pursuant to information by the Commission according to Article 25 Paragraph 3 of Regulation (EU) No 305/2011.

## Specific Part

### 1 Technical description of the product

The "TEKAFIKS VE PLUS" is a bonded anchor consisting of a cartridge with injection mortar "TEKAFIKS VE PLUS" or "TEKAFIKS VE PLUS WINTER" and a steel element. The steel elements are threaded rods with washer and hexagon nut according to Annex A 3 in the range of M8 to M30 or reinforcing bar according to Annex A 3 in the range of Ø 16 to Ø 32.

The steel element is placed into a drilled hole filled with injection mortar and is anchored via the bond between metal part, injection mortar and concrete.

The Illustration and the description of the product are given in Annex A.

### 2 Specification of the intended use in accordance with the applicable European assessment Document

The performances given in Section 3 are only valid if the anchor is used in compliance with the specifications and conditions given in Annex B.

The verifications and assessment methods on which this European Technical Assessment is based lead to the assumption of a working life of the anchor of at least 50 years. The indications given on the working life cannot be interpreted as a guarantee given by the producer, but are to be regarded only as a means for choosing the right products in relation to the expected economically reasonable working life of the works.

### 3 Performance of the product and references to the methods used for its assessment

#### 3.1 Mechanical resistance and stability (BWR 1)

Essential characteristic	Performance
Characteristic resistance for tension loads	See Annex C 1 / C 2
Characteristic resistance for shear loads	See Annex C 3
Displacements under tension loads	See Annex C 1 / C 2
Displacements under shear loads	See Annex C 3

#### 3.2 Safety in case of fire (BWR 2)

Essential characteristic	Performance
Reaction to fire	Anchorage satisfy requirements for Class A1
Resistance to fire	No performance determined (NPD)

#### 3.3 Hygiene, health and the environment (BWR 3)

Regarding dangerous substances there may be requirements (e.g. transposed European legislation and national laws, regulations and administrative provisions) applicable to the products falling within the scope of this European Technical Assessment. In order to meet the provisions of the EU-Construction Products Regulation, these requirements need also to be complied with, when and where they apply.

**3.4 Safety in use (BWR 4)**

For Basic Works Requirement Safety in use the same criteria are valid as for Basic Works Requirement Mechanical resistance and stability.

**3.5 Protection against noise (BWR 5)**

Not applicable.

**3.6 Energy economy and heat retention (BWR 6)**

Not applicable.

**3.7 Sustainable use of natural resources (BWR 7)**

For the sustainable use of natural resources no performance was investigated for this product.

**3.8 General aspects**

The verification of durability is part of testing the essential characteristics. Durability is only ensured if the specifications of intended use according to Annex B are taken into account.

**4 Assessment and verification of constancy of performance (AVCP) system applied, with reference to its legal base**

According to Decision of the Commission of 24 June 1996 (96/582/EC) (OJ L 254 of 08.10.96 p. 62-65), the system of assessment and verification of constancy of performance (see Annex V and Article 65 Paragraph 2 to Regulation (EU) No 305/2011) given in the following table applies.

Product	Intended use	Level or class	System
Metal anchors for use in concrete (heavy-duty type)	For fixing and/or supporting concrete structural elements or heavy units such as cladding and suspended ceilings	—	1

**5 Technical details necessary for the implementation of the AVCP system, as provided for in the applicable European assessment Document**

Technical details necessary for the implementation of the AVCP system are laid down in the control plan deposited at Deutsches Institut für Bautechnik.

Issued in Berlin on 11 April 2014 by Deutsches Institut für Bautechnik

Gerhard Breitschaft  
President

*Beglaubigt:*  
Baderschneider

### Installation threaded rod

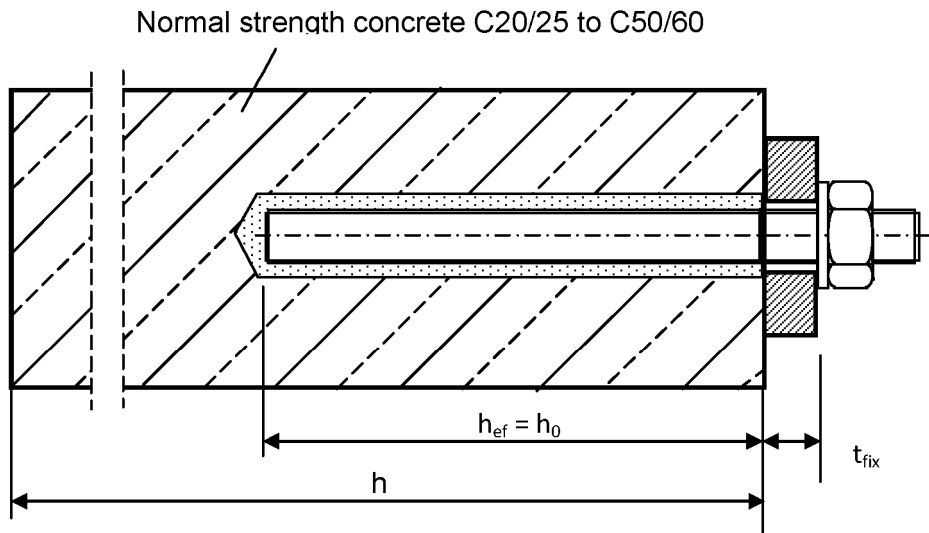

### Installation reinforcing bar

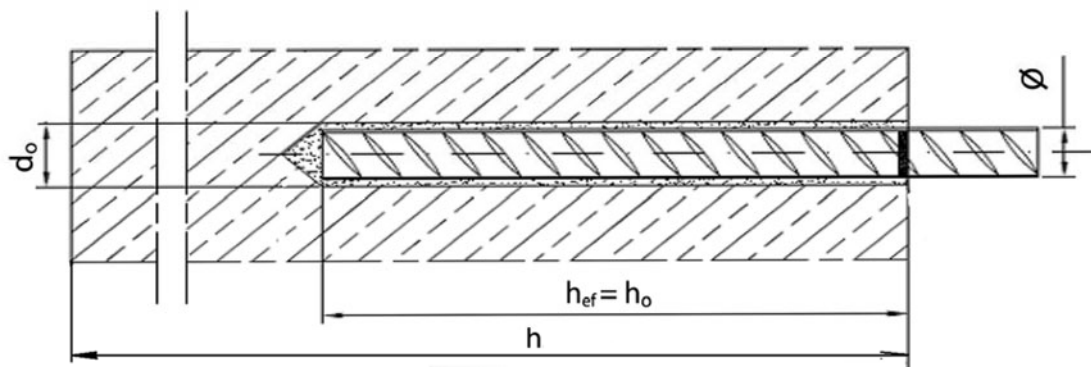

TEKAFIKS VE PLUS, TEKAFIKS VE PLUS WINTER

Product description  
Installed condition

Annex A 1

**Injection mortar "TEKAFIKS VE PLUS" and " TEKAFIKS VE PLUS WINTER"**

**Coaxial cartridges 150 ml, 280 ml, 410 ml**

sealing cap

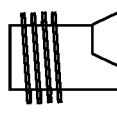
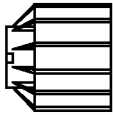

Imprint:  
Trade name, size, processing notes,  
charge code, storage life, hazard code,  
curing- and processing time

**Side-by-side cartridge 345 ml**

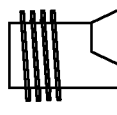
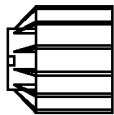

Imprint: see above

Static mixer

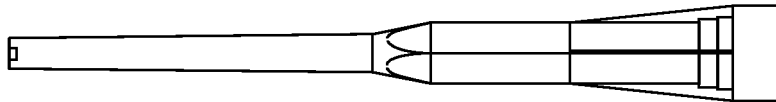

**Piston Plug and Extension hose (for  $h_{ef} > 240$  mm)**

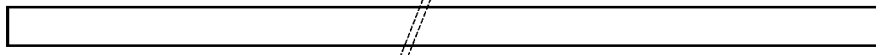
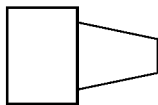

**TEKAFIKS VE PLUS, TEKAFIKS VE PLUS WINTER**

**Product description**  
Injection System

**Annex A 2**

### Threaded rod with washer and hexagon nut M8, M10, M12, M16, M20, M24, M27, M30

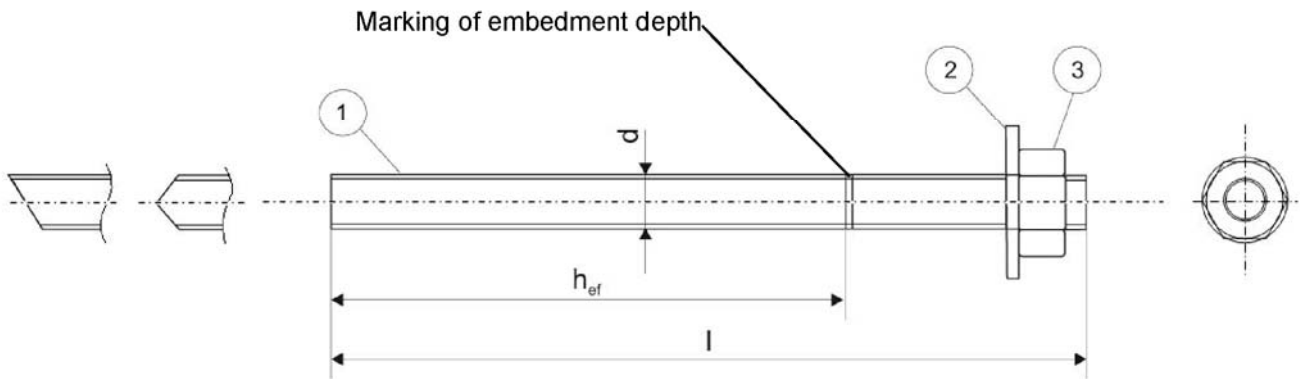

Commercial standard threaded rod M8, M10, M12, M16, M20, M24, M27 or M30 with

- Material and mechanical properties acc. to Table A1
- Confirmation of material and mechanical properties by inspection certificate 3.1 acc. to EN 10204:2004
- Marking of the threaded rod with embedment depth

### Reinforcing Bar $\varnothing 16$ , $\varnothing 20$ , $\varnothing 25$ , $\varnothing 28$ $\varnothing 32$ :

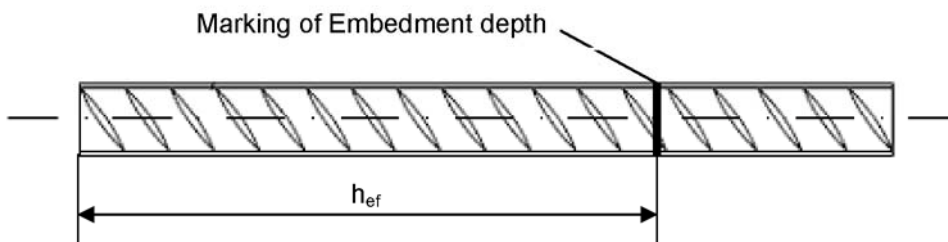

- minimum value of related rip area  $f_{R,min}$  according to EN 1992-1-1:2004+AC:2010
- Rib height of the bar shall be in the range  $0,05 \leq h \leq 0,07d$   
(d: Nominal diameter of the bar, h: Rip height of the bar)

**TEKAFIKS VE PLUS, TEKAFIKS VE PLUS WINTER**

**Product description**  
Anchor rod and reinforcing bar

**Annex A 3**

**Table A1: Materials**

Part	Designation	Material
<b>Steel elements made of zinc coated steel</b>		
1	Threaded rod	Steel, galvanised $\geq 5 \mu\text{m}$ acc. to EN ISO 4042:1999 property class 5.8 or 8.8 acc. to EN 1993-1-8:2005+AC:2009
2	Washer EN ISO 887:2006, EN ISO 7089:2000, EN ISO 7094:2000	Steel, galvanised $\geq 5 \mu\text{m}$ acc. to EN ISO 4042:1999
3	Hexagon nut EN ISO 4032:2012	Steel, galvanised $\geq 5 \mu\text{m}$ acc. to EN ISO 4042:1999 property class 5 or 8 acc. to EN ISO 898-2:2012
<b>Steel elements made of stainless steel</b>		
1	Threaded rod	Stainless steel 1.4401, 1.4404 or 1.4571 property class 70 or 80 acc. to EN ISO 3506-1:2009
2	Washer EN ISO 887:20006 EN ISO 7089:2000, EN ISO 7094:2000	
3	Hexagon nut EN ISO 4032:2012	
<b>Reinforcing bars</b>		
1	Rebar according to EN 1992-1-1:2004+AC:201, Annex C	Bars and de-coiled rods class B or C $f_{yk}$ and $k$ according to NDP or NCL of EN 1992-1-1/NA:2013 $f_{uk} = f_{tk} = k \cdot f_{yk}$

**TEKAFIKS VE PLUS, TEKAFIKS VE PLUS WINTER**

**Product description**  
Materials

**Annex A 4**



## Specifications of intended use

### Anchorage subject to:

- Static and quasi-static loads: all sizes.

### Base materials:

- Reinforced or unreinforced normal weight concrete according to EN 206-1:2000.
- Strength classes C20/25 to C50/60 according to EN 206-1:2000.
- Non-cracked concrete only: all sizes.

### Temperature Range:

- -40°C to +80°C (max. short term temperature +80°C max. long term temperature +72°C)

### Use conditions (Environmental conditions):

- Structures subject to dry internal conditions (zinc coated steel or stainless steel).
- Structures subject to external atmospheric exposure (including industrial and marine environment) and to permanently damp internal condition, if no particular aggressive conditions exist (stainless steel).

Note: Particular aggressive conditions are e.g. permanent, alternating immersion in seawater or the splash zone of seawater, chloride atmosphere of indoor swimming pools or atmosphere with extreme chemical pollution (e.g. in desulphurization plants or road tunnels where de-icing materials are used).

### Design:

- Verifiable calculation notes and drawings are prepared taking account of the loads to be anchored. The position of the anchor is indicated on the design drawings (e. g. position of the anchor relative to reinforcement or to supports, etc.).
- Anchorages are designed under the responsibility of an engineer experienced in anchorages and concrete work.
- Anchorages are designed in accordance with EOTA Technical Report TR 029, Edition September 2010.

### Installation:

- Dry or wet concrete: all sizes.
- The anchor must not be installed in water filled bore holes.
- Hole drilling by hammer-drilling only.
- Anchor installation carried out by appropriately qualified personnel and under the supervision of the person responsible for technical matters of the site.
- Overhead installation only for  $d_0 \leq 35$  mm and  $h_0 \leq 210$  mm.

**TEKAFIKS VE PLUS, TEKAFIKS VE PLUS WINTER**

**Intended Use**  
Specifications

**Annex B 1**

**Table B1: Installation Parameter for Threaded Rods**

Thread diameter		M 8	M 10	M 12	M 16	M 20	M 24	M 27	M 30	
Nominal drill hole diameter	$d_o$ [mm] =	10	12	14	18	24	28	32	35	
Embedment depth = depth of drill hole	$h_{ef,min}$ [mm] =	60	60	70	80	90	96	108	120	
	Concrete Temperature > 0°C	$h_{ef,max}$ [mm] =	160	200	240	320	400	480	540	600
	Concrete Temperature < 0°C	$h_{ef,max}$ [mm] =	80	100	120	160	200	240	270	300
Diameter of clearance hole in the fixture	$d_r$ [mm] ≤	9	12	14	18	22	26	30	33	
Diameter of steel brush	$d_b$ [mm] ≤	12	13,3	14,9	19,35	26	30	34	37	
Torque moment	$T_{inst}$ [Nm] ≤	10	20	40	80	120	160	180	200	
Minimum thickness of member	$h_{min}$ [mm]	$h_{ef} + 30 \text{ mm} \geq 100 \text{ mm}$			$h_{ef} + 2d_o$					
Minimum spacing	$s_{min}$ [mm] =	0,5 $h_{ef}$ ; ≥ 35 mm								
Minimum edge distance	$c_{min}$ [mm] =									

**Table B2: Installation Parameter for Reinforcing Bars**

Diameter of reinforcing bar		Ø 16	Ø 20	Ø 25	Ø 28	Ø 32	
Nominal drill hole diameter	$d_o$ [mm] =	20	25	30	35	40	
Embedment depth = depth of drill hole	$h_{ef,min}$ [mm] =	80	90	100	112	128	
	Concrete Temperature > 0°C	$h_{ef,max}$ [mm] =	320	400	500	560	640
	Concrete Temperature < 0°C	$h_{ef,max}$ [mm] =	160	200	250	280	300
Diameter of steel brush	$d_b$ [mm] ≤	22	26	32	37	44	
Minimum thickness of member	$h_{min}$ [mm] =	$h_{ef} + 2d_o$					
Minimum spacing	$s_{min}$ [mm] =	0,5 $h_{ef}$					
Minimum edge distance	$c_{min}$ [mm] =	0,5 $h_{ef}$					

**Table B3: Maximum processing time and minimum curing time**







TEKAFIKS VE PLUS WINTER			TEKAFIKS VE PLUS		
Concrete Temperature	Maximum processing time	Minimum curing time in dry concrete	Concrete temperature	Maximum processing time	Minimum curing time in dry concrete
[°C]	[minutes]	[hours]	[°C]	[minutes]	[hours]
-20	60	24h			
-15	40	12h			
-10	25	8h			
-5	16	4h			
0	11	3h	0	45	12h
5	7	2h	5	30	8h
10	5	1h30'	10	20	5h
15	3	1h15'	15	12	3h
20	2	1h	20	7	2h
			25	4	1h30'
			30	3	1h15'
			35	2	1h

If the anchor is set in wet concrete, the curing time shall be doubled

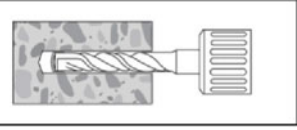
**TEKAFIKS VE PLUS, TEKAFIKS VE PLUS WINTER**

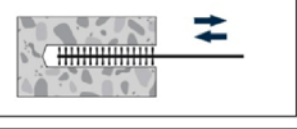
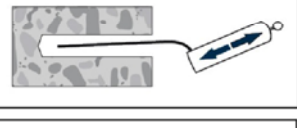
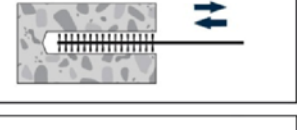
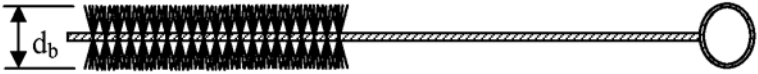
**Intended Use**  
Installation parameters  
Maximum processing time and minimum curing time

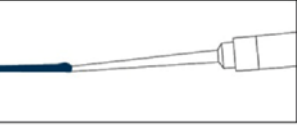
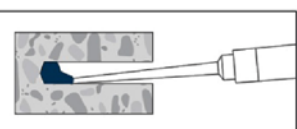
**Annex B 2**

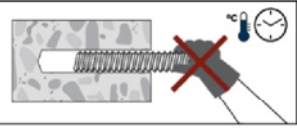
	<p>Drill the hole with the correct diameter and depth using a rotary percussive machine. Check the perpendicularity of the hole during the drilling operation. For concrete temperature <math>-20^{\circ}\text{C} &lt; t &lt; 0^{\circ}\text{C}</math> the bore hole depth is limited to <math>h_0 \leq 10d</math></p>
	<p>Clean the hole from drilling dust, core fragments, oil, water, grease and other contaminants prior to mortar injection with manual blower and standard manual brush. However if it is possible we recommend to blow using oil-free compressed air. Before brushing, clean the brush and check if the brush diameter is correct.</p>
	<p>The hole shall be cleaned by 2 blowing operations / 2 brushing operations / 2 blowing operations / 2 brushing operations to the deepest hole depth. For bore hole depth <math>&gt; 240</math> mm use nozzle extension. The threaded rod and rebar should be free of dirt, grease, oil or other foreign material.</p>
	<p><b>Steel brush</b></p>
	
	<p>For concrete temperature <math>-20^{\circ}\text{C} &lt; t &lt; 0^{\circ}\text{C}</math> only mortar version TEKAFIKS VE PLUS WINTER may be used. Use appropriate static mixer and dispenser. Unscrew the front cup of the cartridge, screw the cartridge on the mixer and insert the cartridge in the gun.</p>
	<p>Before starting to use a new cartridge discard the first swings of the mortar until an homogeneous colour is achieved. For <math>h_{ef} &gt; 240</math> mm use of extension hoses and piston plugs is required</p>
	<p>Inject the mortar starting from the bottom of the hole. In order to avoid entrapment of the air, remove the mixer slowly bit by bit during pressing-out. Filling the drill hole with a quantity of the injection mortar corresponding to 2/3 of the drill hole depth.</p>
	<p>Insert immediately the steel element up to the embedment mark, slowly and with a slight twisting motion, the gap must be completely filled with mortar. Remove excess of injection mortar around the steel element.</p>
	<p>Don't touch the steel element until the curing time has passed.</p>
	

**Table C1: Characteristic values of resistance for threaded rods under tension loads**

Thread size			M 8	M 10	M 12	M 16	M 20	M 24	M 27	M 30
<b>Steel failure</b>										
Characteristic resistance	$N_{Rk,s}$	[kN]	$A_s \times f_{uk}^{1)}$							
<b>Combined pullout and concrete cone failure</b>										
<b>TEKAFIKS VE PLUS and TEKAFIKS VE PLUS WINTER: Temperature of concrete at installation and curing &gt; 0 °C</b>										
Characteristic bond resistance in non-cracked concrete C20/25	$\tau_{Rk,uncr}$	[N/mm <sup>2</sup> ]	11	10	10	9	8,5	7	7	7
<b>Only TEKAFIKS VE PLUS WINTER for Temperature of concrete at installation and curing &gt; - 20 °C</b>										
Characteristic bond resistance in non-cracked concrete C20/25	$\tau_{Rk,uncr}$	[N/mm <sup>2</sup> ]	9	8,5	8,5	7,5	7	6	6	6
Installation safety factor	$\gamma_2$		1,0				1,2	1,4		
Increasing factors for non-cracked concrete $\Psi_c$	C30/37		1,04							
	C40/50		1,08							
	C50/60		1,10							
<b>Splitting failure</b>										
Edge distance	$c_{cr,sp}$	[mm]	$1,0 h_{ef} \leq 2 h_{ef} \text{ ( } 2,5 - h/h_{ef} \text{ ) } \leq 2,4 h_{ef}$							
Spacing	$s_{cr,sp}$	[mm]	$2 c_{cr,sp}$							
Installation safety factor	$\gamma_2$		1,0				1,2	1,4		

<sup>1)</sup> The values  $f_{uk}$  and  $f_{yk}$  are given in the Technical Specification for the relevant material

**Table C2: Displacements under tension loads (threaded rod)**

Thread size			M 8	M 10	M 12	M 16	M 20	M 24	M 27	M 30
Displacement	$\delta_{N0}$	[mm/(N/mm <sup>2</sup> )]	0,39	0,33	0,32	0,33	0,36	0,32	0,52	0,41
Displacement	$\delta_{N\infty}$	[mm/(N/mm <sup>2</sup> )]	0,78	0,66	0,64	0,66	0,72	0,64	1,04	0,82

**TEKAFIKS VE PLUS, TEKAFIKS VE PLUS WINTER**

**Performances**

Characteristic values of resistance for threaded rods under tension loads  
Displacements under tension loads (threaded rod)

**Annex C 1**

**Table C3: Characteristic values for reinforcing bars under tension loads**

Nominal diameter		Ø 16	Ø 20	Ø 25	Ø 28	Ø 32	
<b>Steel failure</b>							
Characteristic resistance	$N_{Rk,s}$	[kN]	$A_s \times f_{uk}$ <sup>1)</sup>				
<b>Combined pullout and concrete cone failure</b>							
<b>TEKAFIKS VE PLUS and TEKAFIKS VE PLUS WINTER: Temperature of concrete at installation and curing &gt; 0 °C</b>							
Characteristic bond resistance in non-cracked concrete C20/25	$\tau_{Rk,uncr}$	[N/mm <sup>2</sup> ]	9	8,5	7	7	6,5
<b>Only TEKAFIKS VE PLUS WINTER for Temperature of concrete at installation and curing &gt; -20 °C</b>							
Characteristic bond resistance in non-cracked concrete C20/25	$\tau_{Rk,uncr}$	[N/mm <sup>2</sup> ]	7,5	7	6	6	5,5
Installation safety factor	$\gamma_2$		1,0	1,2	1,4		
Increasing factors for non-cracked concrete $\Psi_c$	C30/37		1,04				
	C40/50		1,08				
	C50/60		1,10				
<b>Splitting failure</b>							
Edge distance	$c_{cr,sp}$	[mm]	1,0 $h_{ef} \leq 2 h_{ef}$ ( 2,5 - $h/h_{ef}$ ) $\leq 2,4 h_{ef}$				
Spacing	$s_{cr,sp}$	[mm]	2 $c_{cr,sp}$				
Installation safety factor	$\gamma_2$		1,0	1,2	1,4		

<sup>1)</sup> The values  $f_{uk}$  and  $f_{yk}$  are given in the Technical Specification for the relevant material

**Table C4: Displacements under tension loads (reinforcing bar)**

Nominal diameter		Ø 16	Ø 20	Ø 25	Ø 28	Ø 32
Displacement $\delta_{N0}$	[mm/(N/mm <sup>2</sup> )]	0,33	0,36	0,32	0,52	0,41
Displacement $\delta_{N\infty}$	[mm/(N/mm <sup>2</sup> )]	0,66	0,72	0,64	1,04	0,82

-

**TEKAFIKS VE PLUS, TEKAFIKS VE PLUS WINTER**

**Performances**

Characteristic values of resistance for reinforcing bars under tension loads  
Displacements under tension loads (reinforcing bar)

**Annex C 2**

**Table C5: Characteristic values of resistance for threaded rods and reinforcing bars under shear loads**

Thread size			M 8	M 10	M 12	M 16	M 20	M 24	M 27	M 30
Diameter of reinforcing bar						Ø16	Ø20	Ø25	Ø28	Ø32
<b>Steel failure</b>										
Characteristic resistance	$V_{Rk,s}$	[kN]	$0,5 \times A_s \times f_{uk}^{1)}$							
Characteristic bending moment	$M^0_{Rk,s}$	[Nm]	$1,2 \times W_{el} \times f_{uk}^{1)}$							
<b>Concrete pry-out failure</b>										
Factor k in section 5.2.3.3 of TR 029	k	[-]	2,0							
Installation safety factor	$\gamma_2$	[-]	1,0							
<b>Concrete edge failure</b>										
Characteristic resistance	$V_{Rk,c}$	[kN]	See TR 029 Section 5.2.3.4							
Installation safety factor	$\gamma_2$	[-]	1,0							

<sup>1)</sup> The values  $f_{uk}$  and  $f_{yk}$  are given in the Technical Specification for the relevant material,

**Table C6: Displacements under shear loads (threaded rods)**

Diameter of threaded rod			M 8	M 10	M 12	M 16	M 20	M 24	M 27	M 30
Displacement	$\delta_{V0}$	[mm/(kN)]	1,0							
Displacement	$\delta_{V\infty}$	[mm/(kN)]	1,5							

**Table C7: Displacements under shear loads (reinforcing bar)**

Diameter of reinforcing bar			Ø 16	Ø 20	Ø 25	Ø 28	Ø 32
Displacement	$\delta_{V0}$	[mm/(N/mm <sup>2</sup> )]	1,0				
Displacement	$\delta_{V\infty}$	[mm/(N/mm <sup>2</sup> )]	1,5				

**TEKAFIKS VE PLUS, TEKAFIKS VE PLUS WINTER**

**Performances**

Characteristic values of resistance for threaded rods and reinforcing bars under shear loads  
Displacements under shear loads (threaded rod and reinforcing bar)

**Annex C 3**