

Approval body for construction products  
and types of construction

Bautechnisches Prüfamt

An institution established by the Federal and  
Laender Governments



## European Technical Assessment

**ETA-14/0448**  
**of 20 November 2014**

### General Part

Technical Assessment Body issuing the  
European Technical Assessment:

Deutsches Institut für Bautechnik

Trade name of the construction product

Förch FIT Z-B Injection mortar for masonry

Product family  
to which the construction product belongs

Injection system for use in masonry

Manufacturer

Theo Förch GmbH & Co. KG  
Theo-Förch-Straße 11- 15  
74196 Neuenstadt  
DEUTSCHLAND

Manufacturing plant

Förch Werk 1

This European Technical Assessment  
contains

17 pages including 3 annexes which form an integral part  
of this assessment

This European Technical Assessment is  
issued in accordance with Regulation (EU)  
No 305/2011, on the basis of

Guideline for European technical approval of "Metal  
Injection Anchors for Use in Masonry", ETAG 029, April  
2013,  
used as European Assessment Document (EAD)  
according to Article 66 Paragraph 3 of Regulation (EU)  
No 305/2011.

The European Technical Assessment is issued by the Technical Assessment Body in its official language. Translations of this European Technical Assessment in other languages shall fully correspond to the original issued document and shall be identified as such.

Communication of this European Technical Assessment, including transmission by electronic means, shall be in full. However, partial reproduction may only be made with the written consent of the issuing Technical Assessment Body. Any partial reproduction has to be identified as such.

This European Technical Assessment may be withdrawn by the issuing Technical Assessment Body, in particular pursuant to information by the Commission according to Article 25 Paragraph 3 of Regulation (EU) No 305/2011.

## Specific Part

### 1 Technical description of the product

The Förch FIT Z-B Injection mortar for masonry is a bonded anchor (injection type) consisting of a mortar cartridge with injection mortar Förch FIT Z-B, a perforated sleeve and an anchor rod with hexagon nut and washer in the range of M8 to M12. The steel elements are made of zinc coated steel or stainless steel.

The anchor rod is placed into a drilled hole filled with injection mortar and is anchored via the bond between steel element, injection mortar and masonry and mechanical interlock.

The product description is given in Annex A.

### 2 Specification of the intended use in accordance with the applicable European Assessment Document

The performances given in Section 3 are only valid if the anchor is used in compliance with the specifications and conditions given in Annex B.

The verifications and assessment methods on which this European Technical Assessment is based lead to the assumption of a working life of the anchor of at least 50 years. The indications given on the working life cannot be interpreted as a guarantee given by the producer, but are to be regarded only as a means for choosing the right products in relation to the expected economically reasonable working life of the works.

### 3 Performance of the product and references to the methods used for its assessment

#### 3.1 Mechanical resistance and stability (BWR 1)

Essential characteristic	Performance
Characteristic resistance for tension and shear loads	See Annex C 1
Characteristic resistance for bending moments	See Annex C 2
Displacements under shear and tension loads	See Annex C 2
Reduction Factor for job site tests ( $\beta$ -Factor)	See Annex C 2
Edge distances and spacings	See Annex C 3

#### 3.2 Safety in case of fire (BWR 2)

Essential characteristic	Performance
Reaction to fire	Anchorage satisfy requirements for Class A1
Resistance to fire	No performance determined (NPD)

#### 3.3 Hygiene, health and the environment (BWR 3)

Regarding dangerous substances there may be requirements (e.g. transposed European legislation and national laws, regulations and administrative provisions) applicable to the products falling within the scope of this European Technical Assessment. In order to meet the provisions of Regulation (EU) No 305/2011, these requirements need also to be complied with, when and where they apply.

**3.4 Safety in use (BWR 4)**

The essential characteristics regarding Safety in use are included under the Basic Works Requirement Mechanical resistance and stability.

**3.5 Protection against noise (BWR 5)**

Not applicable.

**3.6 Energy economy and heat retention (BWR 6)**

Not applicable.

**3.7 Sustainable use of natural resources (BWR 7)**

The sustainable use of natural resources was not investigated.

**3.8 General aspects**

The verification of durability is part of testing the essential characteristics. Durability is only ensured if the specifications of intended use according to Annex B are taken into account.

**4 Assessment and verification of constancy of performance (AVCP) system applied, with reference to its legal base**

According to Decision of the Commission of 17 February 1997 (97/177/EC) (OJ L 073 of 14.03.97 p. 24-25), the system of assessment and verification of constancy of performance (see Annex V and Article 65 Paragraph 2 to Regulation (EU) No 305/2011) given in the following table applies.

Product	Intended use	Level or class	System
Metal injection anchors for use in masonry	For fixing and/or supporting to masonry, structural elements (which contributes to the stability of the works) or heavy units	—	1

**5 Technical details necessary for the implementation of the AVCP system, as provided for in the applicable European Assessment Document**

Technical details necessary for the implementation of the AVCP system are laid down in the control plan deposited at Deutsches Institut für Bautechnik.

Issued in Berlin on 20 November 2014 by Deutsches Institut für Bautechnik

Uwe Bender  
Head of Department

*beglaubigt:*  
Baderschneider

### Installation in hollow brick; threaded rod with sleeve

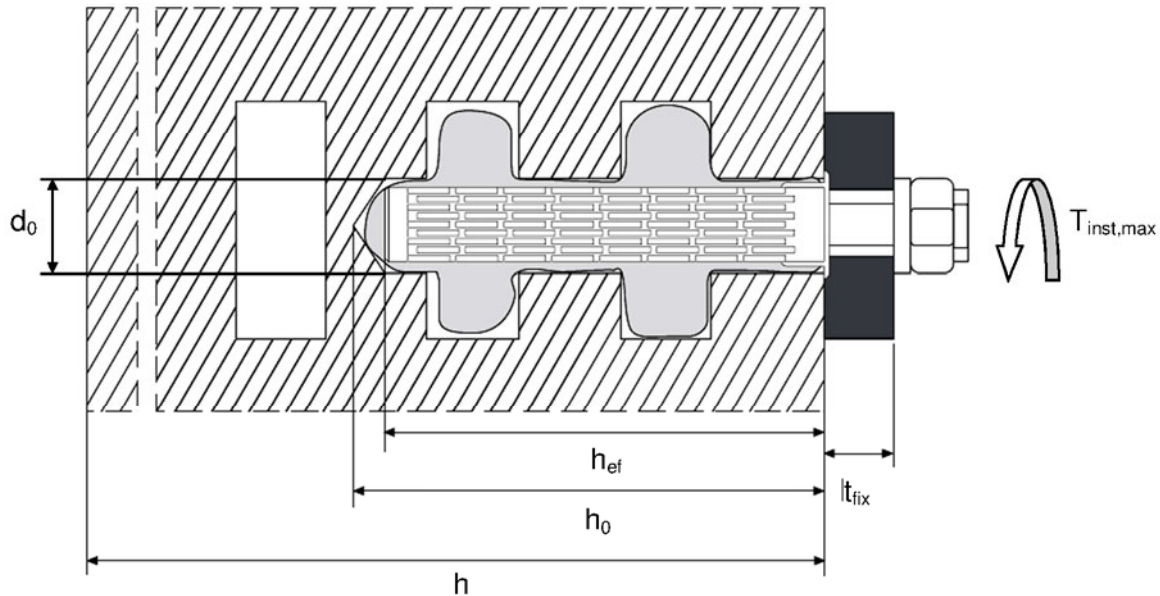

### Installation in solid brick; threaded rod with or without sleeve

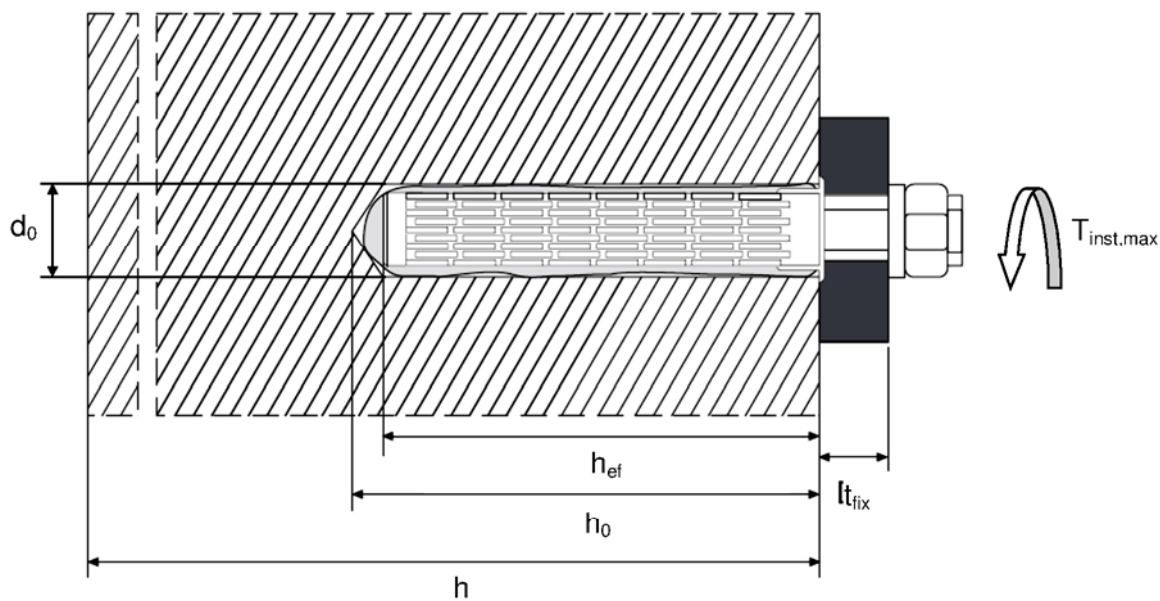

$h_{ef}$  = effective setting depth

$h_0$  = bore hole depth

$t_{fix}$  = thickness of fixture

$d_0$  = bore hole diameter

$T_{inst}$  = torque moment

**Förch FIT Z-B Injektion mortar for masonry**

**Product description**  
Installed condition

**Annex A 1**

**Cartridge: Förch FIT Z-B Injektionsmörtel**

**150 ml, 280 ml, 300 ml up to 333 ml and 380 ml up to 420 ml cartridge (Type: coaxial)**

Sealing/Screw cap

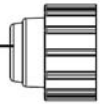

Imprint: Förch FIT Z-B Injektionsmörtel, processing notes, charge-code, shelf life, hazard-code, curing- and processing time (depending on the temperature), with as well as without travel scale

**235 ml, 345 ml and 825 ml cartridge (Type: "side-by-side")**

Sealing/Screw cap

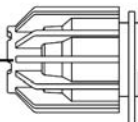

Imprint: Förch FIT Z-B Injektionsmörtel, processing notes, charge-code, shelf life, hazard-code, curing- and processing time (depending on the temperature), with as well as without travel scale

**165 ml and 300 ml cartridge (Type: "foil tube")**

Sealing/Screw cap

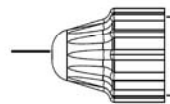

Imprint: Förch FIT Z-B Injektionsmörtel, processing notes, charge-code, shelf life, hazard-code, curing- and processing time (depending on the temperature), with as well as without travel scale

**Static Mixer**

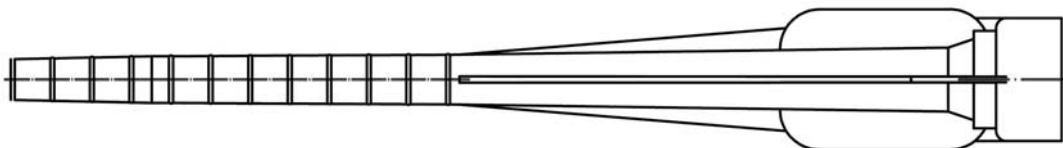

**Förch FIT Z-B Injektion mortar for masonry**

**Product description**  
Injection system

**Annex A 2**

**Threaded rod M8, M8 IG, M10, M12\***

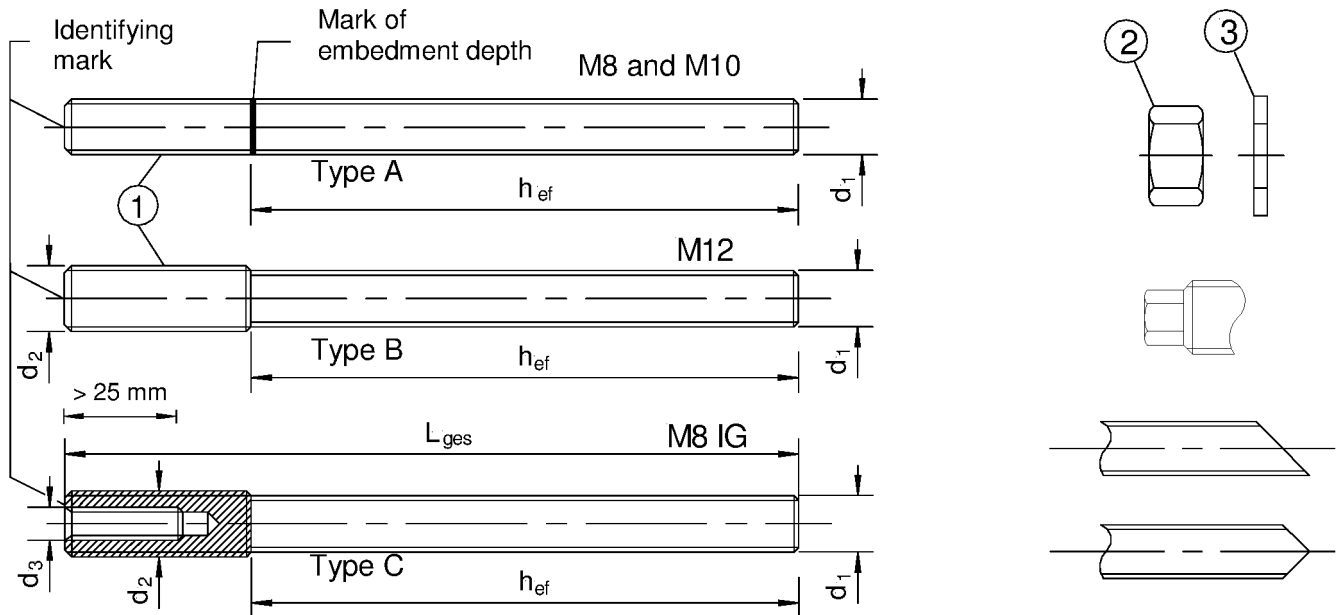

\* M10 at bonding area

With mark (Type A, B, C):

- Identifying mark: CVM; thread size: M
- additional with stainless steel: A4
- e.g. CVM M8 A4

Commercial standard rod (only Type A) with:

- Materials, dimensions and mechanical properties acc. to Table A2
- Inspection certificate 3.1 acc. to EN 10204:2004
- Marking of embedment depth

**Sleeve (Plastic) SH 13 / 100 and SH 15 / 100**

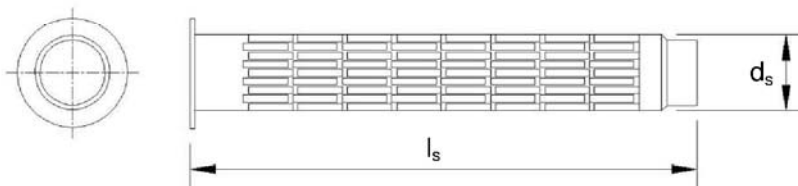

**Table A1: Sizes threaded rod and sleeve (mm)**

Threaded rods							Sleeves		
Size	d <sub>1</sub>	d <sub>2</sub>	d <sub>3</sub>	h <sub>ef</sub>	L <sub>min</sub>	L <sub>max</sub>	Size	d <sub>s</sub>	l <sub>s</sub>
								[mm]	[mm]
M8	8	8	-	80	100	500	SH13/100	13	100
M8 IG	10	12	8	90	110	500	SH15/100	15	100
M10	10	10	-	90	110	500	SH15/100	15	100
M12*	10	12	-	90	110	500	SH15/100	15	100

Förch FIT Z-B Injektion mortar for masonry

**Product description**  
Threaded rod and Sleeve

**Annex A 3**

**Table A2: Materials**

Part	Designation	Material
<b>Steel, zinc plated <math>\geq 5 \mu\text{m}</math> acc. to EN ISO 4042:1999 or Steel, hot-dip galvanised <math>\geq 40 \mu\text{m}</math> acc. to EN ISO 1461:2009 and EN ISO 10684:2004+AC:2009</b>		
1	Anchor rod	Steel, EN 1993-1-8:2005+AC2009 or EN 10263:2001 Strength class 5.8, 8.8 EN 1993-1-8:2005+AC:2009 $f_{yk} = f_{ub}$ $f_{yk} = f_{yb}$
2	Hexagon nut, EN ISO 4032:2012	Strength class 5 (for class 5.8 rod) EN ISO 898-2:2012 Strength class 8 (for class 8.8 rod) EN ISO 898-2:2012
3	Washer, EN ISO 887:2006, EN ISO 7089:2000, EN ISO 7093:2000, or EN ISO 7094:2000	Steel, zinc plated or hot-dip galvanised
<b>Stainless steel</b>		
1	Anchor rod	Material 1.4401 / 1.4404 / 1.4571, EN 10088-1:2005, Strength class 70 EN ISO 3506-1:2009 $f_{yk} = R_{m,min}$ $f_{yk} = R_{p0,2,min}$
2	Hexagon nut, EN ISO 4032:2012	Material 1.4401 / 1.4404 / 1.4571 EN 10088-1:2005, Strength class 70 (for class 70 rod) EN ISO 3506-2:2009
3	Washer, EN ISO 887:2006, EN ISO 7089:2000, EN ISO 7093:2000, or EN ISO 7094:2000	Material 1.4401, 1.4404 or 1.4571, EN 10088-1:2005

**Förch FIT Z-B Injektion mortar for masonry**

**Product description**  
Materials

**Annex A 4**



## Specifications of intended use

### Anchorage subject to:

- Static and quasi-static loads

### Base materials:

- Solid brick masonry (Use category b), according to Annex B 2.  
Note: The characteristic resistance are also valid for larger brick sizes and larger compressive strength of the masonry unit.
- Hollow brick masonry (use category c), according to Annex B 2.
- Mortar strength class of the masonry M2,5 at minimum according to EN 998-2:2010.
- For other bricks in solid masonry and in hollow or perforated masonry, the characteristic resistance of the anchor may be determined by job site tests according to ETAG 029, Annex B under consideration of the  $\beta$ -factor according to Annex C 2, Table C4.

### Temperature Range:

- Ta: - 40°C to +40°C (max. short term temperature +40°C and max. long term temperature +24°C)
- Tb: - 40°C to +80°C (max. short term temperature +80°C and max. long term temperature +50°C)

### Use conditions (Environmental conditions):

- Dry and wet structure (regarding injection mortar).
- Structures subject to dry internal conditions (zinc coated steel, stainless steel or high corrosion resistant steel).
- Structures subject to external atmospheric exposure (including industrial and marine environment) and to permanently damp internal condition, if no particular aggressive conditions exist (stainless steel or high corrosion resistant steel).
- Structures subject to external atmospheric exposure and to permanently damp internal condition, if other particular aggressive conditions exist (high corrosion resistant steel).

Note: Particular aggressive conditions are e.g. permanent, alternating immersion in seawater or the splash zone of seawater, chloride atmosphere of indoor swimming pools or atmosphere with extreme chemical pollution (e.g. in desulphurization plants or road tunnels where de-icing materials are used).

### Use categories in respect of installation and use:

- Category d/d.
- Category w/w.

### Design:

- Verifiable calculation notes and drawings are prepared taking account the relevant masonry in the region of the anchorage, the loads to be transmitted and their transmission to the supports of the structure. The position of the anchor is indicated on the design drawings.
- The anchorages are designed in accordance with the ETAG 029, Annex C, Design method A under the responsibility of an engineer experienced in anchorages and masonry work.

### Installation:

- Dry or wet structures.
- Hole drilling by rotary drill mode.
- Anchor installation carried out by appropriately qualified personnel and under the supervision of the person responsible for technical matters of the site.

**Förch FIT Z-B Injektion mortar for masonry**

**Intended Use**  
Specifications

**Annex B 1**

**Types of brick and dimensions (Dimensions in mm)**

**Brick No. 1**

Calcium silicate  
masonry  
KSV – NF  
acc. to EN 771-1:2011  
 $\rho \geq 1,8$  [kg/dm<sup>3</sup>]  
 $f_b \geq 8$  [N/mm<sup>2</sup>]

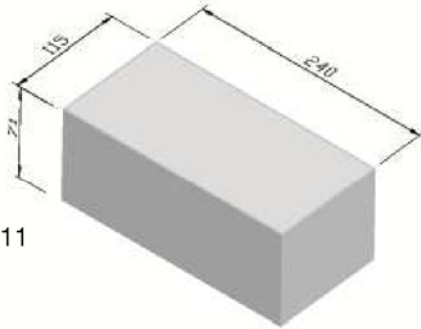

**Brick No. 2**

Clay masonry  
Mz – NF  
acc. to EN 771-1:2011  
 $\rho \geq 1,8$  [kg/dm<sup>3</sup>]  
 $f_b \geq 12$  [N/mm<sup>2</sup>]

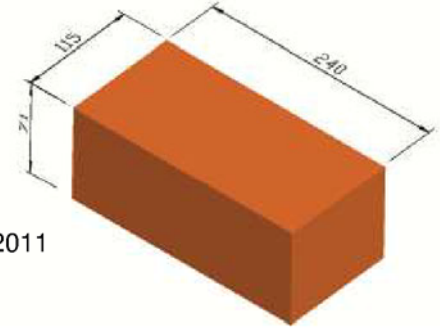

**Brick No. 3**

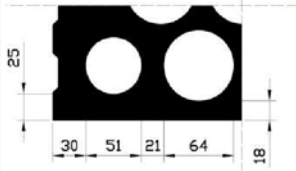
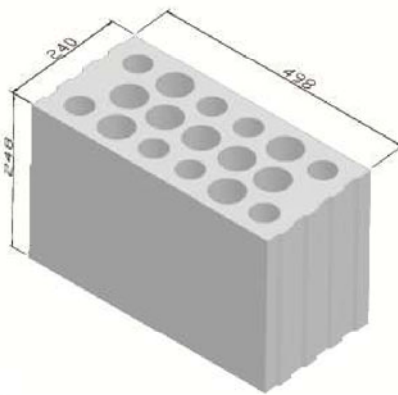

Calcium silicate masonry  
KSL-R-12-1,2-16DF  
acc. to EN 771-1:2011  
 $\rho \geq 1,2$  [kg/dm<sup>3</sup>]  
 $f_b \geq 12$  [N/mm<sup>2</sup>]

**Brick No. 4**

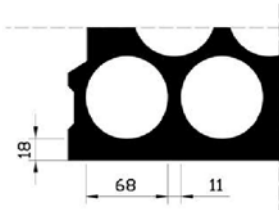
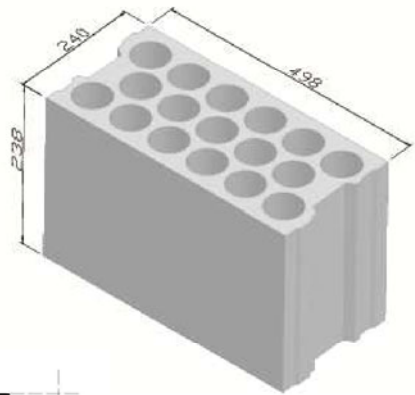

Calcium silicate masonry  
KSL-12-1,2-16DF  
acc. to EN 771-2:2011  
 $\rho \geq 1,2$  [kg/dm<sup>3</sup>]  
 $f_b \geq 12$  [N/mm<sup>2</sup>]

**Brick No. 5**

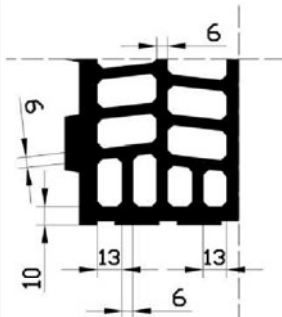
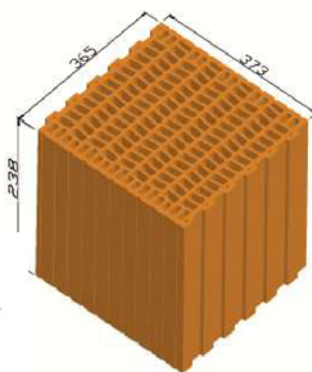

Clay masonry  
Hz-12-0,8-xxDF  
acc. to Z-17.1-383  
 $\rho \geq 0,8$  [kg/dm<sup>3</sup>]  
 $f_b \geq 12$  [N/mm<sup>2</sup>]

**Brick No. 6**

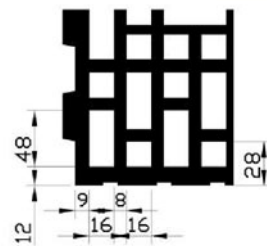
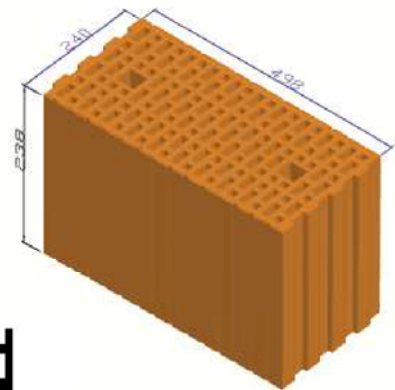

Clay masonry  
Hz-12-0,9-16DF N+F  
acc. to EN 771-1:2011  
 $\rho \geq 0,9$  [kg/dm<sup>3</sup>]  
 $f_b \geq 12$  [N/mm<sup>2</sup>]

**Förch FIT Z-B Injektion mortar for masonry**

**Intended Use**

Types of brick and dimensions

**Annex B 2**

## Installation

### Cleaning Brush

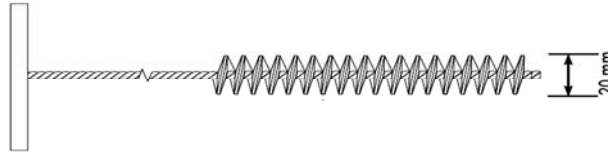

**Table B1: Installation parameters in solid masonry (without sleeve)**

Threaded rod			M8	M8 IG	M10	M12
Nominal drill hole diameter	$d_0$	[mm]	10	12	12	12
Embedment depth	$h_{ef}$	[mm]	80	90	90	90
Bore hole depth	$h_0$	[mm]	85	95	95	95
Diameter of clearance hole in the fixture	$d_f \leq$	[mm]	9	14	12	14
Diameter of nylon brush	$d_b \geq$	[mm]	20			
Torque moment	$T_{inst}$	[Nm]	2			

**Table B2: Installation parameters in solid and hollow masonry (with sleeve)**

Threaded rod			M8	M8 IG	M10	M12
Sleeve			SH 13x100	SH 15x100	SH 15x100	SH 15x100
Nominal drill hole diameter	$d_0$	[mm]	14	16	16	16
Embedment depth sleeve	$h_{nom}$	[mm]	100	100	100	100
Embedment depth rod	$h_{ef}$	[mm]	80	90	90	90
Bore hole depth	$h_0$	[mm]	105	105	105	105
Diameter of clearance hole in the fixture	$d_f \leq$	[mm]	9	14	12	14
Diameter of nylon brush	$d_b \geq$	[mm]	20			
Torque moment	$T_{inst}$	[Nm]	2			

**Table B3: Minimum curing time**

Base material temperature	Gelling- / working time	Minimum curing time in dry base material <sup>1)</sup>
+ 5 °C to +9 °C	25 min	2 h
+ 10 °C to +19 °C	15 min	80 min
+ 20 °C to +29 °C	6 min	45 min
+ 30 °C to +34 °C	4 min	25 min
+ 35 °C to +40 °C	2 min	20 min

<sup>1)</sup> In wet base material the curing time **must** be doubled

## Förch FIT Z-B Injektion mortar for masonry

### Intended Use

Installation parameters and cleaning brush  
Gelling and Curing times

## Annex B 3

**Table B4: Allocation of anchor rods<sup>1)</sup>, sleeves<sup>1)</sup> and bricks**

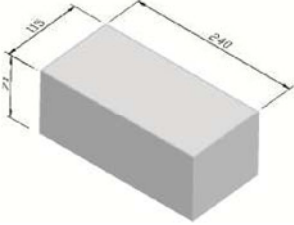
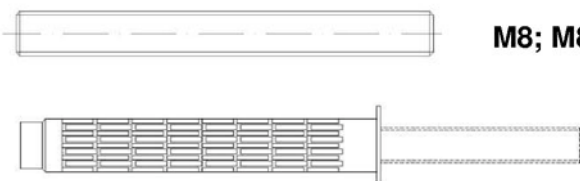
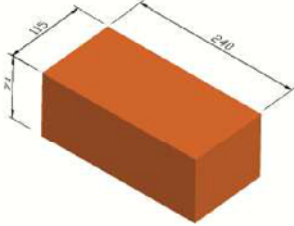
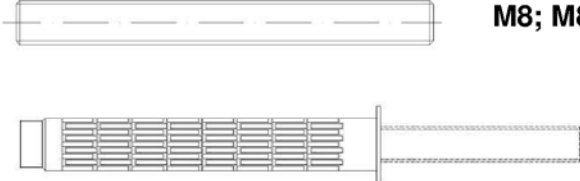
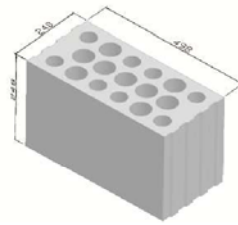
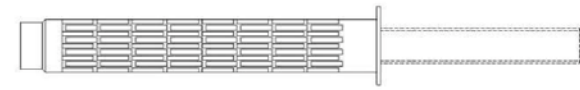
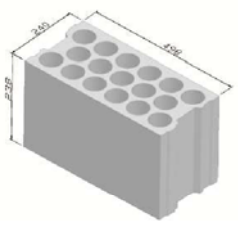
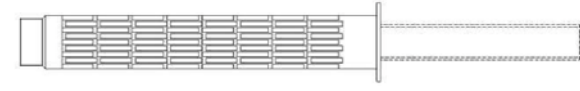
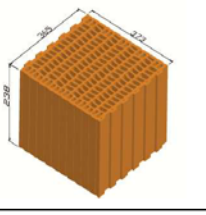
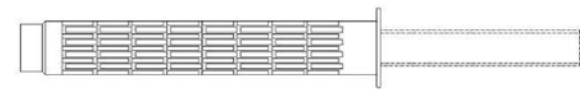
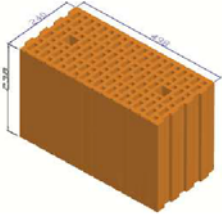
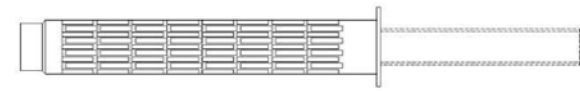
Bricks	Valid anchor rods and sleeves	* M10 at bonding area
 <p><b>No 1</b></p>		<p><b>M8; M8IG; M10; M12*</b></p> <p><b>SH 13x100</b> <b>SH 15x100</b></p>
 <p><b>No 2</b></p>		<p><b>M8; M8IG; M10; M12*</b></p> <p><b>SH 13x100</b> <b>SH 15x100</b></p>
 <p><b>No 3</b></p>		<p><b>SH 13x100</b></p>
 <p><b>No 4</b></p>		<p><b>SH 13x100</b> <b>SH 15x100</b></p>
 <p><b>No 5</b></p>		<p><b>SH 13x100</b> <b>SH 15x100</b></p>
 <p><b>No 6</b></p>		<p><b>SH 13x100</b></p>

1) Other combination can be use after job side test acc. to ETAG 029, Annex B.  
The  $\beta$ -factors for this job side test are given in Table C4

**Förch FIT Z-B Injektion mortar for masonry**

**Intended Use**

Allocation of anchor rods, sleeves and bricks

**Annex B 4**

## Installation instructions

### Preparation of cartridge

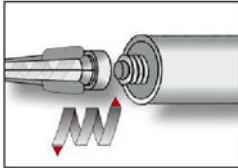

1. Remove the cap and attach the supplied static-mixing nozzle to the cartridge and load the cartridge into the correct dispensing tool. Cut off the foil tube clip before use. For every working interruption longer than the recommended working time (Table B3) as well as for new cartridges, a new static-mixer shall be used.

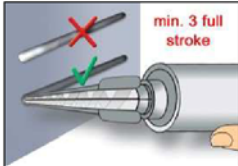

2. Place in the cartridge to an appropriate dispenser tool. Prior to dispensing into the anchor hole, squeeze out separately a minimum of three full strokes and discard non-uniformly mixed adhesive components until the mortar shows a consistent grey colour.

### Installation in solid masonry (without sleeve)

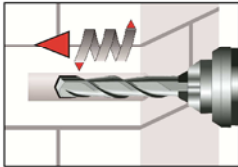

3. Holes to be drilled perpendicular to the surface of the base material by using a hard-metal tipped hammer drill bit. Drill a hole, by rotary drill mode, into the base material, with nominal drill hole diameter and bore hole depth acc. to the size and embedment depth required by the selected anchor. In case of aborted drill hole the drill hole shall be filled with mortar.

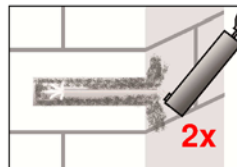
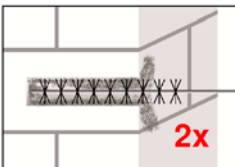
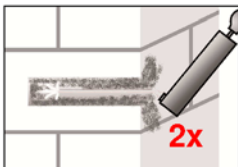

4. Blow from the bottom of the bore hole two times. Brush the hole clean two times, and finally blow out the hole again two times.

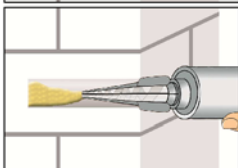

5. Starting from the bottom or back of the cleaned anchor hole fill the hole up to min two-thirds with adhesive. Slowly withdraw the static mixing nozzle as the hole fills to avoid creating air pockets. Observe the gel-/ working times given in Table B3.

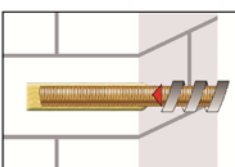
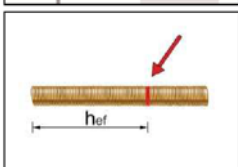

6. The position of the embedment depth shall be marked on the threaded rod. Push the threaded rod into the anchor hole while turning slightly to ensure positive distribution of the adhesive until the embedment depth is reached. The anchor should be free of dirt, grease, oil or other foreign material.

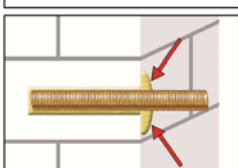

7. Be sure that the anular gap is fully filled with mortar. If no excess mortar is visible at the top of the hole, the application has to be renewed.

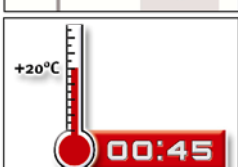

8. Allow the adhesive to cure to the specified curing time prior to applying any load or torque. Do not move or load the anchor until it is fully cured (attend Table B3).

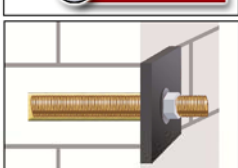

9. After full curing, the fixture can be installed with the max. torque (Table B1 or B2) by using a calibrated torque wrench.

## Förch FIT Z-B Injektion mortar for masonry

### Intended Use

Installation instructions (solid brick)

## Annex B 5

### Installation in solid and hollow masonry (with sleeve)

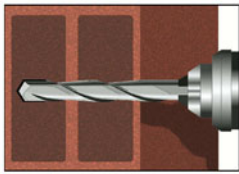

3. Holes to be drilled perpendicular to the surface of the base material by using a hard-metal tipped hammer drill bit. Drill a hole, by rotary drill mode, into the base material, with nominal drill hole diameter and bore hole depth acc. to the size and embedment depth required by the selected anchor. In case of aborted drill hole the drill hole shall be filled with mortar

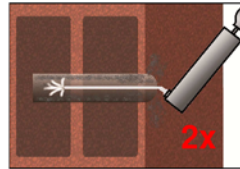
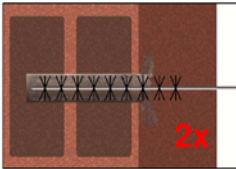
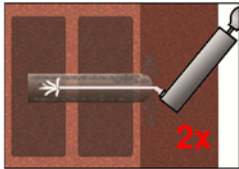

4. Blow from the bottom of the bore hole two times. Brush the hole clean two times, and finally blow out the hole again two times.

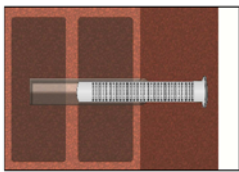

5. Insert the perforated sleeve into the bore hole. Make sure that the sleeve fits well into the hole. Never cut the sleeve! Only use sleeves that have the right length.

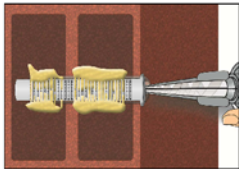

6. Starting from the bottom or back fill the sleeve completely with adhesive. For quantity of mortar attend cartridge label. Observe the gel-/ working times given in Table B3.

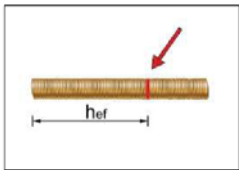

7. The position of the embedment depth shall be marked on the threaded rod. Push the threaded rod into the anchor hole while turning slightly to ensure positive distribution of the adhesive until the embedment depth is reached. The anchor should be free of dirt, grease, oil or other foreign material.

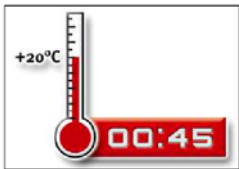

8. Allow the adhesive to cure to the specified curing time prior to applying any load or torque. Do not move or load the anchor until it is fully cured (attend Table B3).

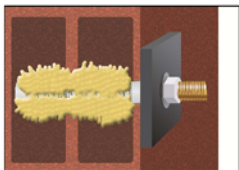

9. After full curing, the fixture can be installed with the max. torque (Table B2) by using a calibrated torque wrench.

**Förch FIT Z-B Injektion mortar for masonry**

**Intended Use**

Installation instructions (hollow brick)

**Annex B 6**

**Table C1: Characteristic values of resistance for tension and shear loads**

Brick No.	Density $\rho$ [kg/dm <sup>3</sup> ] Compressive strength $f_b$ [N/mm <sup>2</sup> ]	Sleeve	Anchor size	Effective Embedment depth $h_{ef}$ [mm]	Characteristic resistance							
					Use category							
					dry / dry (d/d)				wet / wet (w/w)			
					Ta: 24°C/40°C		Tb: 50°C/80°C		Ta: 24°C/40°C		Tb: 50°C/80°C	
					$N_{Rk}^{1)}$	$V_{Rk}^{2,3)}$	$N_{Rk}^{1)}$	$V_{Rk}^{2,3)}$	$N_{Rk}^{1)}$	$V_{Rk}^{2,3)}$	$N_{Rk}^{1)}$	$V_{Rk}^{2,3)}$
[kN]		[kN]		[kN]		[kN]						
1	$\rho \geq 1,8$ $f_b \geq 8$	without	M8	80	4,0	4,0	3,0	3,0	3,0	3,0	2,5	2,5
		without	M8 IG; M10; M12	90	5,0	5,0	4,5	4,5	4,0	4,0	3,5	3,5
		SH 13x100	M8	80	5,0	5,0	4,5	4,5	4,5	4,5	3,5	3,5
		SH 15x100	M8 IG; M10; M12	90	7,0	7,0	6,0	6,0	5,0	5,0	4,5	4,5
2	$\rho \geq 1,8$ $f_b \geq 12$	without	M8	80	4,0	4,0	3,0	3,0	3,5	3,5	3,0	3,0
		without	M8 IG; M10; M12	90	5,0	5,0	4,5	4,5	5,0	5,0	4,0	4,0
		SH 13x100	M8	80	3,5	3,5	3,0	3,0	3,5	3,5	2,5	2,5
		SH 15x100	M8 IG; M10; M12	90	4,5	4,5	3,5	3,5	4,5	4,5	3,5	3,5
3	$\rho \geq 1,2$ $f_b \geq 12$	SH 13x100	M8	80	3,5	2,5	3,5	2,5	3,0	2,0	3,0	2,0
4	$\rho \geq 1,2$ $f_b \geq 12$	SH 13x100	M8	80	2,5	2,0	2,5	2,0	2,0	1,5	2,0	1,5
		SH 15x100	M8 IG; M10; M12	90	3,0	2,5	3,0	2,5	2,0	2,0	2,0	2,0
5	$\rho \geq 0,8$ $f_b \geq 12$	SH 13x100	M8	80	2,0	2,0	2,0	2,0	2,0	2,0	2,0	2,0
		SH 15x100	M8 IG; M10; M12	90	2,0	2,5	2,0	2,5	2,0	2,5	2,0	2,5
6	$\rho \geq 0,9$ $f_b \geq 12$	SH 13x100	M8	80	3,0	2,0	3,0	2,0	2,5	2,0	2,5	2,0

1) For design according to ETAG 029, Annex C:  $N_{Rk} = N_{Rk,p} = N_{Rk,b} = N_{Rk,s}$

2) For design according to ETAG 029, Annex C:  $V_{Rk} = V_{Rk,b} = V_{Rk,s}$

3)  $V_{Rk,c}$  according to ETAG 029, Annex C

**Förch FIT Z-B Injektion mortar for masonry**

**Performances**

Characteristic values of resistance for tension load and shear load values

**Annex C 1**

**Table C2: Characteristic values of resistance for bending moments**

			M8	M8 IG <sup>1)</sup>	M10	M12 <sup>1)</sup>
Characteristic bending moment, Steel, property class 5.8	$M_{Rk,s}$	[Nm]	19	37	37	37
Characteristic bending moment, Steel, property class 8.8	$M_{Rk,s}$	[Nm]	30	60	60	60
Characteristic bending moment, Stainless steel A4, property class 70	$M_{Rk,s}$	[Nm]	26	52	52	52

<sup>1)</sup> M10 at bonding area

**Table C3: Displacement under shear and tension load**

Brick-No.	N [kN]	$\delta_{N0}$ [mm]	$\delta_{N\infty}$ [mm]	V [kN]	$\delta_{V0}$ [mm]	$\delta_{V\infty}$ [mm]
1	$\frac{N_{Rk}}{1,4 \times \gamma_M}$	0,1	0,2	$\frac{V_{Rk}}{1,4 \times \gamma_M}$	$\frac{V_{Rk} \text{ [kN]}}{2,0 \text{ [kN/mm]}}$	1,5 $\delta_{V0}$
2					0,7	1,1
3						
4						
5						
6						

**Table C4:  $\beta$ -factors for job site tests according to ETAG 029, Annex B**

Brick-No.	Installation & use	$\beta$ -factor	
		Ta: 24°C / 40°C	Tb: 50°C / 80°C
1-2	d/d	0,66	0,53
3-6		0,92	
1	w/w (incl. w/d)	0,53	0,42
2		0,61	0,49
3		0,74	
4		0,74	
5		0,86	
6		0,86	

**Förch FIT Z-B Injektion mortar for masonry**

**Performances**

Characteristic values of resistance for bending moments,  
Displacements,  $\beta$ -factors for job site tests

**Annex C 2**



**Table C5: Edge distances and spacings**

Brick No.	Anchor size					
	M8			M8 IG, M10, M12		
	$C_{min} = C_{cr}$ [mm]	$S_{min,  } = S_{cr,  }^{1)}$ [mm]	$S_{min,\perp} = S_{cr,\perp}^{2)}$ [mm]	$C_{min} = C_{cr}$ [mm]	$S_{min,  } = S_{cr,  }^{1)}$ [mm]	$S_{min,\perp} = S_{cr,\perp}^{2)}$ [mm]
1	120 (150) <sup>3)</sup>	240 (300) <sup>3)</sup>	240 (300) <sup>3)</sup>	135 (150) <sup>3)</sup>	270 (300) <sup>3)</sup>	270 (300) <sup>3)</sup>
2	120 (150) <sup>3)</sup>	240 (300) <sup>3)</sup>	240 (300) <sup>3)</sup>	135 (150) <sup>3)</sup>	270 (300) <sup>3)</sup>	270 (300) <sup>3)</sup>
3	100	498	248	100	498	248
4	100	498	238	100	498	238
5	100	373	238	100	373	238
6	100	498	238	100	498	238

<sup>1)</sup>  $s_{||}$  : Spacing parallel to the bearing joint

<sup>2)</sup>  $s_{\perp}$  : Spacing perpendicular to the bearing joint

<sup>3)</sup> with perforated sleeve

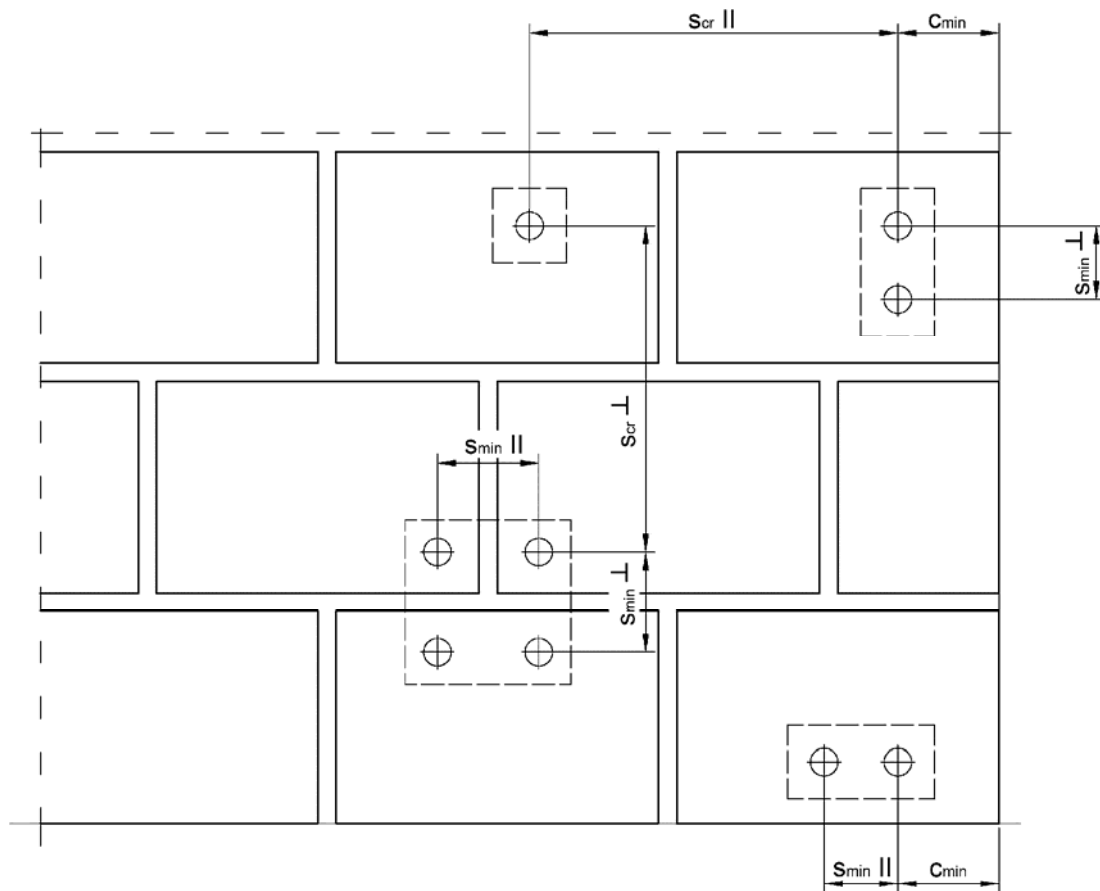

**Förch FIT Z-B Injektion mortar for masonry**

**Performances**  
Edge distances and spacings

**Annex C 3**