

Approval body for construction products
and types of construction

Bautechnisches Prüfamt

An institution established by the Federal and
Laender Governments



European Technical Assessment

ETA-02/0044
of 26 March 2015

English translation prepared by DIBt - Original version in German language

General Part

Technical Assessment Body issuing the
European Technical Assessment:

Deutsches Institut für Bautechnik

Trade name of the construction product

Würth Drop-in Anchor W-ED/S, W-ED/S BND, W-ED/A4,
W-ED/A4 BND, W-ED/HCR and W-ED/HCR BND

Product family
to which the construction product belongs

Deformation-controlled expansion anchor made of
galvanised or stainless steel of sizes M6,
M8, M10, M12, M16 and M20
for use in non-cracked concrete

Manufacturer

Adolf Würth GmbH & Co. KG
Reinhold-Würth-Straße 12-17
74653 Künzelsau
DEUTSCHLAND

Manufacturing plant

Herstellwerk W1, DEUTSCHLAND

This European Technical Assessment
contains

16 pages including 3 annexes which form an integral part
of this assessment

This European Technical Assessment is
issued in accordance with Regulation (EU)
No 305/2011, on the basis of

Guideline for European technical approval of "Metal
anchors for use in concrete", ETAG 001 Part 4:
"Deformation controlled expansion anchors", April 2013,
used as European Assessment Document (EAD)
according to Article 66 Paragraph 3 of Regulation (EU)
No 305/2011.

European Technical Assessment
ETA-02/0044

Page 2 of 16 | 26 March 2015

English translation prepared by DIBt

The European Technical Assessment is issued by the Technical Assessment Body in its official language. Translations of this European Technical Assessment in other languages shall fully correspond to the original issued document and shall be identified as such.

Communication of this European Technical Assessment, including transmission by electronic means, shall be in full. However, partial reproduction may only be made with the written consent of the issuing Technical Assessment Body. Any partial reproduction has to be identified as such.

This European Technical Assessment may be withdrawn by the issuing Technical Assessment Body, in particular pursuant to information by the Commission according to Article 25 Paragraph 3 of Regulation (EU) No 305/2011.

Specific Part

1 Technical description of the product

The Würth Drop-in Anchor W-ED/S, W-ED/S BND, W-ED/A4, W-ED/A4 BND, W-ED/HCR und W-ED/HCR BND is an anchor made of galvanised steel, made of stainless steel or high corrosion resistant steel which is placed into a drilled hole and anchored by deformation-controlled expansion.

The product description is given in Annex A.

2 Specification of the intended use in accordance with the applicable European Assessment Document

The performances given in Section 3 are only valid if the anchor is used in compliance with the specifications and conditions given in Annex B.

The verifications and assessment methods on which this European Technical Assessment is based lead to the assumption of a working life of the anchor of at least 50 years. The indications given on the working life cannot be interpreted as a guarantee given by the producer, but are to be regarded only as a means for choosing the right products in relation to the expected economically reasonable working life of the works.

3 Performance of the product and references to the methods used for its assessment

3.1 Mechanical resistance and stability (BWR 1)

| Essential characteristic | Performance |
|----------------------------------------------------------------------------------------------|----------------------|
| Characteristic resistance for tension and shear loads as well as bending moments in concrete | See Annex C 1 to C 4 |
| Edge distances and spacing | See Annex C 1 to C 2 |
| Displacements under tension and shear loads | See Annex C 5 |

3.2 Safety in case of fire (BWR 2)

| Essential characteristic | Performance |
|--------------------------|---------------------------------------------|
| Reaction to fire | Anchorage satisfy requirements for Class A1 |
| Resistance to fire | No performance determined (NPD) |

3.3 Hygiene, health and the environment (BWR 3)

Not applicable.

3.4 Safety in use (BWR 4)

The essential characteristics regarding Safety in use are included under the Basic Works Requirement Mechanical resistance and stability.

3.5 Protection against noise (BWR 5)

Not applicable.

3.6 Energy economy and heat retention (BWR 6)

Not applicable.

3.7 Sustainable use of natural resources (BWR 7)

The sustainable use of natural resources was not investigated.

English translation prepared by DIBt

3.8 General aspects

The verification of durability is part of testing the essential characteristics. Durability is only ensured if the specifications of intended use according to Annex B are taken into account.

4 Assessment and verification of constancy of performance (AVCP) system applied, with reference to its legal base

According to Decision of the Commission of 24 June 1996 (96/582/EC) (OJ L 254 of 08.10.96 p. 62-65), the system of assessment and verification of constancy of performance (see Annex V and Article 65 Paragraph 2 to Regulation (EU) No 305/2011) given in the following table applies.

| Product | Intended use | Level or class | System |
|-----------------------------------------------------|------------------------------------------------------------------------------------------------------------------|----------------|--------|
| Metal anchors for use in concrete (heavy-duty type) | For fixing and/or supporting concrete structural elements or heavy units such as cladding and suspended ceilings | — | 1 |

5 Technical details necessary for the implementation of the AVCP system, as provided for in the applicable European Assessment Document

Technical details necessary for the implementation of the AVCP system are laid down in the control plan deposited at Deutsches Institut für Bautechnik.

Issued in Berlin on 26 March 2015 by Deutsches Institut für Bautechnik

Andreas Kummerow
p.p. Head of Department

beglaubigt:
Baderschneider

Drop-in Anchor W-ED

Anchor size

Type BND

M6x30

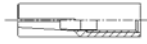

M6x30



M8x30

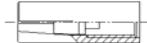

M8x30



M8x40

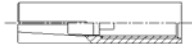

M8x40

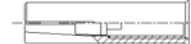

M10x30
(zinc plated only)



M10x40



M10x40



M12x50



M12x50



M12x80



M12x80



M16x65

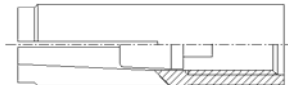

M16x65



M16x80



M16x80



M20x80

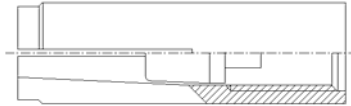

Würth Drop-in Anchor W-ED/S, W-ED/S BND, W-ED/A4, W-ED/A4 BND, W-ED/HCR, W-ED/HCR BND

Product description
Anchor size

Annex A1

Installation situation

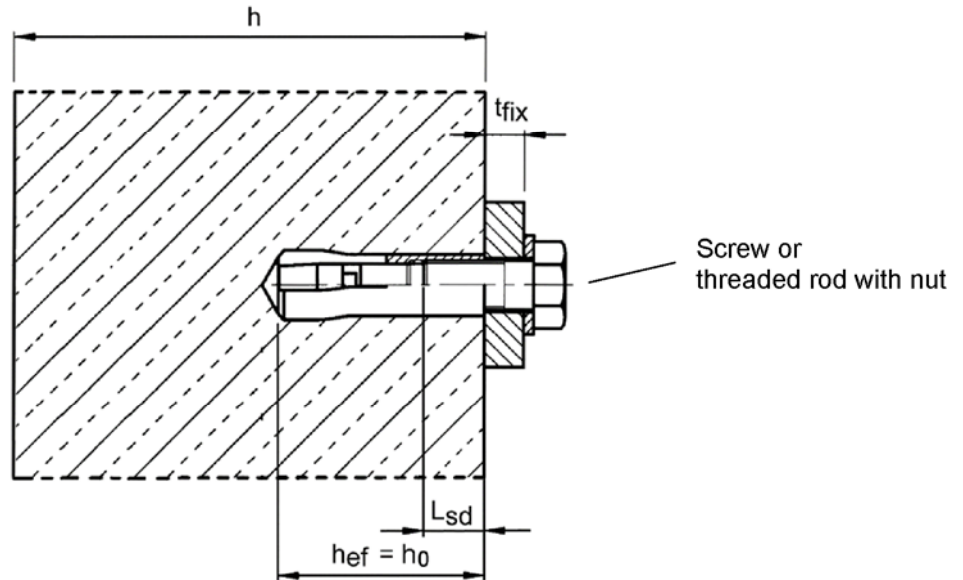

Table A1: Designations of anchor parts and material

| Part | Designation | Steel, zinc plated | Stainless steel A4 | High corrosion resistant steel HCR |
|------|---------------|---------------------------------------------------------------|-------------------------------------------------------------------------------------------------------------|---------------------------------------------------------------------------------------------|
| 1 | Anchor sleeve | Cold formed or machining steel, zinc plated, EN ISO 4042:1999 | Stainless steel, 1.4401, 1.4404, 1.4571, 1.4362, EN 10088:2005, Property class 70, acc. to EN ISO 3506:2010 | Stainless steel, 1.4529, 1.4565, EN 10088:2005, Property class 70, acc. to EN ISO 3506:2010 |
| 2 | Cone | Steel for cold forming acc. to EN 10263-2:2001 | Stainless steel, 1.4401, 1.4404, 1.4571, 1.4362, EN 10088:2005 | |

Würth Drop-in Anchor W-ED/S, W-ED/S BND, W-ED/A4, W-ED/A4 BND, W-ED/HCR, W-ED/HCR BND

Product description
Installation situation and material

Annex A2

Anchor sleeve

Anchor version without shoulder

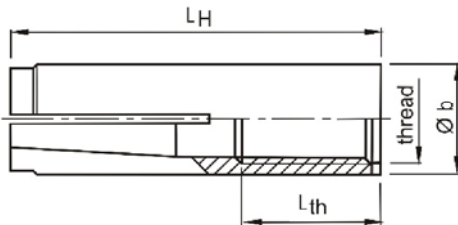

Marking: see Table A2

e.g.: \diamond E M8x40

\diamond Identifying mark of manufacturing plant
E Anchor identity (version without shoulder)
ES Anchor identity (version with shoulder)
M8 Size of thread
40 Anchorage depth

Anchor version with shoulder Type BND

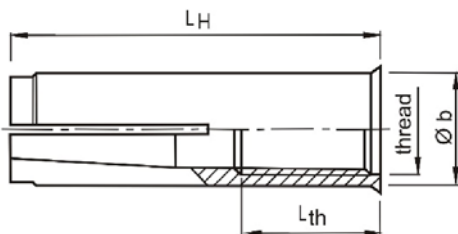

A4 additional marking of stainless steel A4

HCR additional marking of high corrosion resistant steel

Cone

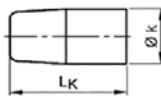

Size M6x30 and M10x30

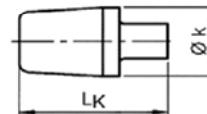

Size M8x30 – M20x80

Table A2: Dimensions and marking

| Anchor size | Anchor sleeve | | | | Cone | | Marking | | |
|-------------|---------------|------|----------------|-----------------|---------------------|----------------------|---------------------|----------------------|---------------------|
| | thread | Ø b | L _H | L _{th} | Ø k | L _K | version E | version ES | alternatively |
| M6x30 | M6 | 8 | 30 | 13 | 5.0 | 13 | \diamond E M6x30 | \diamond ES M6x30 | \diamond E M6 |
| M8x30 | M8 | 10 | 30 | 13 | 6.5 | 12 | \diamond E M8x30 | \diamond ES M8x30 | \diamond E M8 |
| M8x40 | M8 | 10 | 40 | 20 | | | \diamond E M8x40 | \diamond ES M8x40 | \diamond E M8x40 |
| M10x30 | M10 | 12 | 30 | 12 | 8.2 | 12 | - | \diamond ES M10x30 | \diamond E M10x30 |
| M10x40 | M10 | 12 | 40 | 15 | 8.2 | 16 | \diamond E M10x40 | \diamond ES M10x40 | \diamond E M10 |
| M12x50 | M12 | 15 | 50 | 18 | | | 10.3 | 20 | \diamond E M12x50 |
| M12x80 | M12 | 15 | 80 | 45 | \diamond E M12x80 | \diamond ES M12x80 | | | \diamond E M12x80 |
| M16x65 | M16 | 19.7 | 65 | 23 | 13.8 | 29 | \diamond E M16x65 | \diamond ES M16x65 | \diamond E M16 |
| M16x80 | M16 | 19.7 | 80 | 38 | | | \diamond E M16x80 | \diamond ES M16x80 | \diamond E M16x80 |
| M20x80 | M20 | 24.7 | 80 | 34 | 16.5 | 30 | \diamond E M20x80 | - | \diamond E M20 |

Dimensions in mm

Würth Drop-in Anchor W-ED/S, W-ED/S BND, W-ED/A4, W-ED/A4 BND, W-ED/HCR, W-ED/HCR BND

Product description
Dimensions and marking

Annex A3

Setting tool for marking

Marking: see Table A3
e.g. \diamond M E/ES M8x40

Verification of correct installation with setting tool for marking
The setting tool leaves a visible marking after correct installation.

Setting tool

Marking: see Table A3
e.g. \diamond E/ES M8x40

Table A3: Dimensions and marking of setting tools

| Anchor size | Ø m | f | g | Setting tool for marking | | Setting tool | |
|-------------|------|----|----|--------------------------|-----------------------|------------------------|---------------------|
| | | | | | alternatively | | alternatively |
| M6x30 | 4.9 | 17 | 27 | \diamond M E/ES M6x30 | \diamond M E M6 | \diamond E/ES M6x30 | \diamond E M6 |
| M8x30 | 6.4 | 18 | 28 | \diamond M E/ES M8x30 | \diamond M E M8 | \diamond E/ES M8x30 | \diamond E M8 |
| M8x40 | 6.4 | 28 | 38 | \diamond M E/ES M8x40 | \diamond M E M8x40 | \diamond E/ES M8x40 | \diamond E M8x40 |
| M10x30 | 8.0 | 18 | 28 | \diamond M ES M10x30 | \diamond M E M10x30 | \diamond ES M10x30 | \diamond E M10x30 |
| M10x40 | 8.0 | 24 | 34 | \diamond M E/ES M10x40 | \diamond M E M10 | \diamond E/ES M10x40 | \diamond E M10 |
| M12x50 | 10.0 | 30 | 40 | \diamond M E/ES M12x50 | \diamond M E M12 | \diamond E/ES M12x50 | \diamond E M12 |
| M12x80 | 10.0 | 60 | 70 | \diamond M E/ES M12x80 | \diamond M E M12x80 | \diamond E/ES M12x80 | \diamond E M12x80 |
| M16x65 | 13.5 | 36 | 46 | \diamond M E/ES M16x65 | \diamond M E M16 | \diamond E/ES M16x65 | \diamond E M16 |
| M16x80 | 13.5 | 51 | 61 | \diamond M E/ES M16x80 | \diamond M E M16x80 | \diamond E/ES M16x80 | \diamond E M16x80 |
| M20x80 | 16.5 | 50 | 60 | \diamond M E M20x80 | \diamond M E M20 | \diamond E M20x80 | \diamond E M20 |

Dimensions in mm

| | |
|----------------------------------------------------------------------------------------------|-----------------|
| Würth Drop-in Anchor W-ED/S, W-ED/S BND, W-ED/A4, W-ED/A4 BND, W-ED/HCR, W-ED/HCR BND | Annex A4 |
| Product description Setting tools, dimensions and marking | |

Specifications of intended use

Anchorage subject to:

- Static and quasi-static loads

Base materials:

- Reinforced or unreinforced normal weight concrete according to EN 206-1:2000
- Non-cracked concrete
- Strength classes C20/25 to C50/60 according to EN 206-1:2000

Use conditions:

- Structures subject to dry internal conditions (zinc plated steel, stainless steel or high corrosion resistant steel).
- Structures subject to external atmospheric exposure including industrial and marine environment or exposure to permanently damp internal condition, if no particular aggressive conditions exist (stainless steel or high corrosion resistant steel).
- Structures subject to external atmospheric exposure and to permanently damp internal condition, if other particular aggressive conditions (high corrosion resistant steel).

Note: Particular aggressive conditions are e.g. permanent, alternating immersion in seawater or the splash zone of seawater, chloride atmosphere of indoor pools or atmosphere with extreme chemical pollution (e.g. in desulphurization plants or road tunnels where de-icing materials are used.)

Design:

- Anchorages are designed under the responsibility of an engineer experienced in anchorages and concrete work.
- Verifiable calculation notes and drawings are prepared taking account of the loads to be anchored. The position of the anchor is indicated on the design drawings (e.g. position of the anchor relative to reinforcement or to supports, etc.).
- The strength class and the length of the fastening screw or threaded rod shall be defined by the designing engineer
- Anchorages under static or quasi-static actions are designed in accordance with:
 - ETAG 001, Annex C, design method A, Edition August 2010 or
 - CEN/TS 1992-4:2009, Annex C, design method A

Installation:

- Anchor installation carried out by appropriately qualified personnel and under the supervision of the person responsible for technical matters of the site,
- Anchor installation in accordance with the manufacturer's specifications and drawings and using the appropriate tools,
- Drill hole by hammer drilling only,
- Positioning of the drill holes without damaging the reinforcement.

Würth Drop-in Anchor W-ED/S, W-ED/S BND, W-ED/A4, W-ED/A4 BND, W-ED/HCR, W-ED/HCR BND

Intended use
Specifications

Annex B1

Table B1: Installation parameters

| Anchor size | | M6x30 | M8x30 | M8x40 | M10x30 | M10x40 | M12x50 | M12x80 | M16x65 | M16x80 | M20x80 |
|-------------------------------------------|----------------------|-------|-------|-------|--------|--------|--------|--------|--------|--------|--------|
| Depth of drill hole | $h_0 =$ [mm] | 30 | 30 | 40 | 30 | 40 | 50 | 80 | 65 | 80 | 80 |
| Drill hole diameter | $d_0 =$ [mm] | 8 | 10 | 10 | 12 | 12 | 15 | 15 | 20 | 20 | 25 |
| Cutting diameter of drill bit | $d_{cut} \leq$ [mm] | 8.45 | 10.45 | 10.45 | 12.5 | 12.5 | 15.5 | 15.5 | 20.55 | 20.55 | 25.55 |
| Max. installation torque ¹⁾ | $T_{inst} \leq$ [Nm] | 4 | 8 | 8 | 15 | 15 | 35 | 35 | 60 | 60 | 120 |
| Diameter of clearance hole in the fixture | $d_f \leq$ [mm] | 7 | 9 | 9 | 12 | 12 | 14 | 14 | 18 | 18 | 22 |
| Available thread length | L_{th} [mm] | 13 | 13 | 20 | 12 | 15 | 18 | 45 | 23 | 38 | 34 |
| Minimum screw-in depth | L_{sdmin} [mm] | 7 | 9 | 9 | 10 | 11 | 13 | 13 | 18 | 18 | 22 |
| Steel, zinc plated | | | | | | | | | | | |
| Minimum thickness of member | h_{min} [mm] | 100 | 100 | 100 | 120 | 120 | 130 | 130 | 160 | 160 | 200 |
| Minimum spacing | s_{min} [mm] | 55 | 60 | 80 | 100 | 100 | 120 | 120 | 150 | 150 | 160 |
| Minimum edge distance | c_{min} [mm] | 95 | 95 | 95 | 115 | 135 | 165 | 165 | 200 | 200 | 260 |
| Stainless steel A4, HCR | | | | | | | | | | | |
| Minimum thickness of member | h_{min} [mm] | 100 | 100 | 100 | - | 130 | 140 | 140 | 160 | 160 | 250 |
| Minimum spacing | s_{min} [mm] | 50 | 60 | 80 | - | 100 | 120 | 120 | 150 | 150 | 160 |
| Minimum edge distance | c_{min} [mm] | 80 | 95 | 95 | - | 135 | 165 | 165 | 200 | 200 | 260 |

¹⁾ If the screw or threaded rod is otherwise secured against unscrewing, the torque can be omitted.

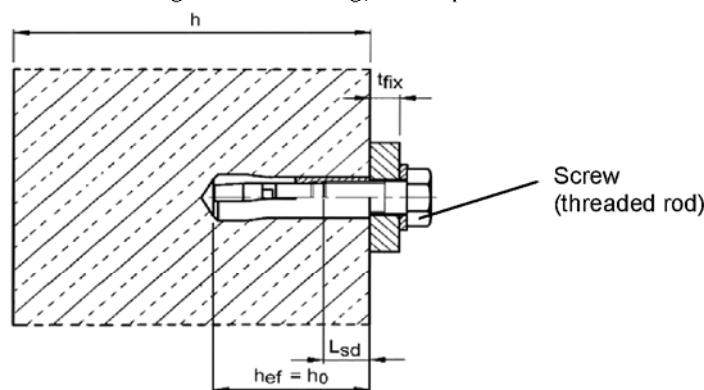

Requirements of the fastening screw or the threaded rod and nut according to the engineering documents:

- Minimum screw-in depth L_{sdmin} see Table B1
- The length of screw or the threaded rod shall be determined depending on the thickness of fixture t_{fix} , available thread length L_{th} (= maximum screw-in depth) and the minimum screw-in depth L_{sdmin} .
- $A_5 > 8\%$ ductility

Steel, zinc plated

- Property class 4.6 / 5.6 / 5.8 or 8.8 according to EN ISO 898-1:2013-05 or EN ISO 898-2:2012

Stainless steel A4

- Material 1.4401; 1.4404; 1.4578; 1.4571; 1.4439; 1.4362 EN 10088:2005
- Property class 70 or 80 according to EN ISO 3506:2010

High corrosion resistant steel (HCR)

- Material 1.4529; 1.4565 EN 10088:2005
- Property class 70 or 80 according to EN ISO 3506:2010

Würth Drop-in Anchor W-ED/S, W-ED/S BND, W-ED/A4, W-ED/A4 BND, W-ED/HCR, W-ED/HCR BND

Intended use
Installation parameters

Annex B2

Installation instructions

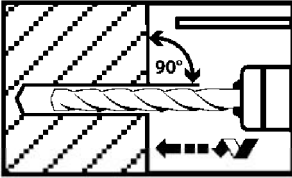

Drill hole perpendicular to concrete surface.

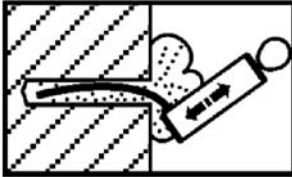

Blow out dust.

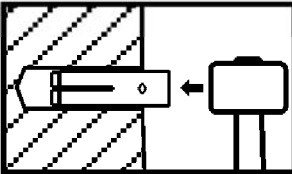

Drive in anchor.

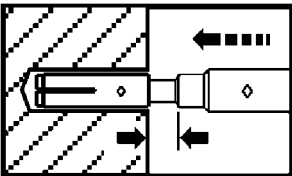

Drive in cone by using setting tool.

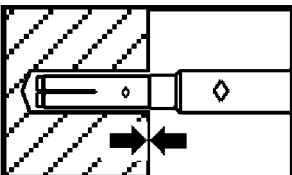

Shoulder of setting tool must fit on anchor rim.

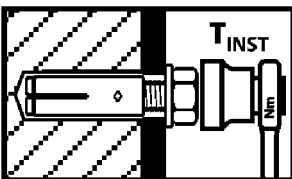

Apply installation torque T_{inst} by using torque wrench.

Würth Drop-in Anchor W-ED/S, W-ED/S BND, W-ED/A4, W-ED/A4 BND,
W-ED/HCR, W-ED/HCR BND

Intended use
Installation instructions

Annex B3

Table C1: Characteristic values for tension loads, zinc plated steel
(Design method A according to ETAG 001, Annex C or CEN/TS 1992-4)

| Anchor size | | | M6x30 ¹⁾ | M8x30 ¹⁾ | M8x40 | M10x30 ¹⁾ | M10x40 | M12x50 M12x80 | M16x65 M16x80 | M20x80 | |
|----------------------------------------------|-----------------------------|------|---------------------------------------------|---------------------|-------|----------------------|--------|------------------|------------------|--------|--|
| Installation safety factor | $\gamma_2 = \gamma_{inst}$ | [-] | 1.2 | | | | | | | | |
| Steel failure | | | | | | | | | | | |
| Characteristic resistance Steel 4.6 | $N_{Rk,s}$ | [kN] | 8.0 | 14.6 | | 23.2 | | 33.7 | 62.8 | 98.0 | |
| Partial safety factor | γ_{Ms} | [-] | 2.0 | | | | | | | | |
| Characteristic resistance Steel 5.6 | $N_{Rk,s}$ | [kN] | 10.0 | 18.3 | | 18.0 | 20.2 | 42.1 | 78.3 | 122.4 | |
| Partial safety factor | γ_{Ms} | [-] | 2.0 | | | 1.5 | | 2.0 | | | |
| Characteristic resistance Steel 5.8 | $N_{Rk,s}$ | [kN] | 10.0 | 17.6 | 18.3 | 18.0 | 20.2 | 42.1 | 67.1 | 106.4 | |
| Partial safety factor | γ_{Ms} | [-] | 1.5 | | | | | | 1.6 | | |
| Characteristic resistance Steel 8.8 | $N_{Rk,s}$ | [kN] | 15.0 | 17.6 | 19.9 | 18.0 | 20.2 | 43.0 | 67.1 | 106.4 | |
| Partial safety factor | γ_{Ms} | [-] | 1.5 | | | | | | 1.6 | | |
| Pull-out failure | | | | | | | | | | | |
| Characteristic resistance in concrete C20/25 | $N_{Rk,p}$ | [kN] | 2) | 2) | 9 | 2) | 2) | 2) | 2) | 2) | |
| Increasing factor for $N_{Rk,p}$ | ψ_C | [-] | $\left(\frac{f_{ck,cube}}{25}\right)^{0.3}$ | | | | | | | | |
| Concrete cone failure and splitting | | | | | | | | | | | |
| Effective anchorage depth | h_{ef} | [mm] | 30 | 30 | 40 | 30 | 40 | 50 | 65 | 80 | |
| Spacing (edge distance) | $s_{cr,N} (= 2 c_{cr,N})$ | [mm] | 3 h_{ef} | | | | | | | | |
| | $s_{cr,sp} (= 2 c_{cr,sp})$ | [mm] | 190 | 190 | 190 | 230 | 270 | 330 | 400 | 520 | |
| Factor according to CEN/TS 1992-4 | k_{ucr} | [-] | 10.1 | | | | | | | | |

¹⁾ Use restricted to anchoring of structural components statically indeterminate and in dry interior conditions

²⁾ Pull-out is not decisive

Würth Drop-in Anchor W-ED/S, W-ED/S BND, W-ED/A4, W-ED/A4 BND, W-ED/HCR, W-ED/HCR BND

Performance
Characteristic values for **tension loads, zinc plated steel**
(Design method A according to ETAG 001, Annex C or CEN/TS 1992-4)

Annex C1

Table C2: Characteristic values for tension loads, stainless steel A4, HCR
(Design method A according to ETAG 001, Annex C or CEN/TS 1992-4)

| Anchor size | | M6x30 ¹⁾ | M8x30 ¹⁾ | M8x40 | M10x40 | M12x50 M12x80 | M16x65 M16x80 | M20x80 | |
|-----------------------------------------------|-----------------------------|---------------------|---------------------|---------------------------------------------|--------|------------------|------------------|--------|-----|
| Installation safety factor | $\gamma_2 = \gamma_{inst}$ | [-] | | 1.0 | | | | | |
| Steel failure | | | | | | | | | |
| Characteristic resistance (property class 70) | $N_{Rk,s}$ | [kN] | 14.1 | 23.3 | 29.4 | 50.2 | 83.8 | 133.0 | |
| Characteristic resistance (property class 80) | $N_{Rk,s}$ | [kN] | 17.5 | 23.3 | 29.4 | 50.2 | 83.8 | 133.0 | |
| Partial safety factor | γ_{Ms} | [-] | | 1.87 | | | | | |
| Pull-out failure | | | | | | | | | |
| Characteristic resistance in concrete C20/25 | $N_{Rk,p}$ | [kN] | 2) | 2) | 9 | 2) | 2) | 2) | |
| Increasing factor for $N_{Rk,p}$ | ψ_C | [-] | | $\left(\frac{f_{ck,cube}}{25}\right)^{0.5}$ | | | | | |
| Concrete cone failure and splitting | | | | | | | | | |
| Effective anchorage depth | h_{ef} | [mm] | 30 ³⁾ | 30 | 40 | 40 | 50 | 65 | 80 |
| Spacing (edge distance) | $s_{cr,N} (= 2 C_{cr,N})$ | [mm] | 3 h_{ef} | | | | | | |
| | $s_{cr,sp} (= 2 C_{cr,sp})$ | [mm] | 160 | 190 | 190 | 270 | 330 | 400 | 520 |
| Factor according to CEN/TS 1992-4 | k_{ucr} | [-] | | 10.1 | | | | | |

¹⁾ Use restricted to anchoring of structural components statically indeterminate and in dry interior conditions

²⁾ Pull-out is not decisive

³⁾ For proof against concrete cone failure as per ETAG 001, annex C or CEN/TS 1992-4-4, $N_{Rk,c}^0$ must be multiplied by the factor $(25/f_{ck,cube})^{0.2}$.

Würth Drop-in Anchor W-ED/S, W-ED/S BND, W-ED/A4, W-ED/A4 BND, W-ED/HCR, W-ED/HCR BND

Performance
Characteristic values for **tension loads, stainless steel A4, HCR**
(Design method A according to ETAG 001, Annex C or CEN/TS 1992-4)

Annex C2

Table C3: Characteristic values for **shear loads, zinc plated steel**
(Design method A according to ETAG 001, Annex C or CEN/TS 1992-4)

| Anchor size | | M6x30 | M8x30 | M8x40 | M10x30 | M10x40 | M12x50 M12x80 | M16x65 M16x80 | M20x80 |
|-------------------------------------------------------------|-------------------|-------|-------|-------|--------|--------|------------------|------------------|--------|
| Steel failure without lever arm | | | | | | | | | |
| Characteristic resistance Steel 4.6 | $V_{Rk,s}$ [kN] | 4.0 | 7.3 | | 11.6 | 9.6 | 16.8 | 31.3 | 49.0 |
| Partial safety factor | γ_{Ms} [-] | 1.67 | | | | | | | |
| Characteristic resistance Steel 5.6 | $V_{Rk,s}$ [kN] | 5.0 | 9.1 | | 10.1 | 9.6 | 21.1 | 39.2 | 61.2 |
| Partial safety factor | γ_{Ms} [-] | 1.67 | | | 1.25 | 1.67 | | | |
| Characteristic resistance Steel 5.8 | $V_{Rk,s}$ [kN] | 5.0 | 6.9 | | 10.1 | 7.2 | 21.1 | 33.5 | 53.2 |
| Partial safety factor | γ_{Ms} [-] | 1.25 | | | | | | 1.33 | |
| Characteristic resistance Steel 8.8 | $V_{Rk,s}$ [kN] | 5.0 | 6.9 | | 10.1 | 7.2 | 21.5 | 33.5 | 53.2 |
| Partial safety factor | γ_{Ms} [-] | 1.25 | | | | | | 1.33 | |
| Factor of ductility | k_2 [-] | 1.0 | | | | | | | |
| Steel failure with lever arm | | | | | | | | | |
| Characteristic resistance Steel 4.6 | $M^0_{Rk,s}$ [Nm] | 6.1 | 15 | | 30 | 30 | 52 | 133 | 259 |
| Partial safety factor | γ_{Ms} [-] | 1.67 | | | | | | | |
| Characteristic resistance Steel 5.6 | $M^0_{Rk,s}$ [Nm] | 7.6 | 19 | | 37 | 37 | 65 | 166 | 324 |
| Partial safety factor | γ_{Ms} [-] | 1.67 | | | | | | | |
| Characteristic resistance Steel 5.8 | $M^0_{Rk,s}$ [Nm] | 7.6 | 19 | | 37 | 37 | 65 | 166 | 324 |
| Partial safety factor | γ_{Ms} [-] | 1.25 | | | | | | | |
| Characteristic resistance Steel 8.8 | $M^0_{Rk,s}$ [Nm] | 12 | 30 | | 59 | 60 | 105 | 266 | 519 |
| Partial safety factor | γ_{Ms} [-] | 1.25 | | | | | | | |
| Factor of ductility | k_2 [-] | 1.0 | | | | | | | |
| Concrete pry-out failure | | | | | | | | | |
| Factor k acc. ETAG 001, Annex C or k_3 acc. CEN/TS 1992-4 | $k_{(3)}$ [-] | 1.0 | | | | | 1.5 | 2.0 | |
| Concrete edge failure | | | | | | | | | |
| Effective length of anchor under shear loading | l_f [mm] | 30 | 30 | 40 | 30 | 40 | 50 | 65 | 80 |
| Outside diameter of anchor | d_{nom} [mm] | 8 | 10 | 10 | 12 | 12 | 15 | 20 | 25 |

Würth Drop-in Anchor W-ED/S, W-ED/S BND, W-ED/A4, W-ED/A4 BND, W-ED/HCR, W-ED/HCR BND

Annex C3

Performance
Characteristic values for **shear loads, zinc plated steel**
(Design method A according to ETAG 001, Annex C or CEN/TS 1992-4)

Table C4: Characteristic values for **shear loads, stainless steel A4, HCR**
(Design method A according to ETAG 001, Annex C or CEN/TS 1992-4)

| Anchor size | | | M6x30 | M8x30 | M8x40 | M10x40 | M12x50 M12x80 | M16x65 M16x80 | M20x80 |
|----------------------------------------------------------------|---------------|------|-------|-------|-------|--------|------------------|------------------|--------|
| Steel failure without lever arm | | | | | | | | | |
| Characteristic resistance (property class 70) | $V_{Rk,s}$ | [kN] | 7.0 | 10.6 | | 13.4 | 25.1 | 41.9 | 66.5 |
| Characteristic resistance (property class 80) | $V_{Rk,s}$ | [kN] | 8.7 | 10.6 | | 13.4 | 25.1 | 41.9 | 66.5 |
| Partial safety factor | γ_{Ms} | [-] | 1.56 | | | | | | |
| Factor of ductility | k_2 | [-] | 1.0 | | | | | | |
| Steel failure with lever arm | | | | | | | | | |
| Characteristic resistance (property class 70) | $M^0_{Rk,s}$ | [Nm] | 11 | 26 | | 52 | 92 | 233 | 454 |
| Partial safety factor | γ_{Ms} | [-] | 1.56 | | | | | | |
| Characteristic resistance (property class 80) | $M^0_{Rk,s}$ | [Nm] | 12 | 30 | | 60 | 105 | 266 | 519 |
| Partial safety factor | γ_{Ms} | [-] | 1.33 | | | | | | |
| Factor of ductility | k_2 | [-] | 1.0 | | | | | | |
| Concrete pry-out failure | | | | | | | | | |
| Factor k acc. ETAG 001, Annex C or k_3 acc. CEN/TS 1992-4 | $k_{(3)}$ | [-] | 1.0 | 1.7 | | 1.7 | | 2.0 | |
| Concrete edge failure | | | | | | | | | |
| Effective length of anchor under shear loading | l_f | [mm] | 30 | 30 | 40 | 40 | 50 | 65 | 80 |
| Outside diameter of anchor | d_{nom} | [mm] | 8 | 10 | 10 | 12 | 15 | 20 | 25 |

**Würth Drop-in Anchor W-ED/S, W-ED/S BND, W-ED/A4, W-ED/A4 BND,
W-ED/HCR, W-ED/HCR BND**

Performance

Characteristic values for **shear loads, stainless steel A4, HCR**
(Design method A according to ETAG 001, Annex C or CEN/TS 1992-4)

Annex C4

Table C5: Displacements under tension loads

| Anchor size | | | M6x30 | M8x30 | M8x40 | M10x30 | M10x40 | M12x50 M12x80 | M16x65 M16x80 | M20x80 |
|--------------------------------------|--------------------|------|-------|-------|-------|--------|--------|------------------|------------------|--------|
| Steel zinc plated | | | | | | | | | | |
| Tension load in non-cracked concrete | N | [kN] | 3 | 3 | 3.6 | 3.3 | 4.8 | 6.4 | 10 | 14.8 |
| Displacement | δ_{N0} | [mm] | 0.24 | | | | | | | |
| | $\delta_{N\infty}$ | [mm] | 0.36 | | | | | | | |
| Stainless steel A4 / HCR | | | | | | | | | | |
| Tension load in non-cracked concrete | N | [kN] | 4 | 4 | 4.3 | - | 6.1 | 8.5 | 12.6 | 17.2 |
| Displacement | δ_{N0} | [mm] | 0.12 | | | | | | | |
| | $\delta_{N\infty}$ | [mm] | 0.24 | | | | | | | |

Table C6: Displacements under shear loads

| Anchor size | | | M6x30 | M8x30 | M8x40 | M10x30 | M10x40 | M12x50 M12x80 | M16x65 M16x80 | M20x80 |
|------------------------------------|--------------------|------|-------|-------|-------|--------|--------|------------------|------------------|--------|
| Steel zinc plated | | | | | | | | | | |
| Shear load in non-cracked concrete | V | [kN] | 2 | 4 | 4 | 5.7 | 4.0 | 11.3 | 18.8 | 32.2 |
| Displacement | δ_{V0} | [mm] | 0.9 | 0.9 | 1.0 | 1.5 | 0.6 | 1.2 | 1.2 | 1.6 |
| | $\delta_{V\infty}$ | [mm] | 1.3 | 1.3 | 1.5 | 2.3 | 0.9 | 1.9 | 1.9 | 2.4 |
| Stainless steel A4 / HCR | | | | | | | | | | |
| Shear load in non-cracked concrete | V | [kN] | 3.5 | 5.2 | 5.2 | - | 6.5 | 11.5 | 19.2 | 30.4 |
| Displacement | δ_{V0} | [mm] | 1.9 | 1.1 | 0.7 | - | 1.0 | 1.7 | 2.4 | 2.6 |
| | $\delta_{V\infty}$ | [mm] | 2.8 | 1.6 | 1.0 | - | 1.5 | 2.6 | 3.6 | 3.8 |

Würth Drop-in Anchor W-ED/S, W-ED/S BND, W-ED/A4, W-ED/A4 BND, W-ED/HCR, W-ED/HCR BND

**Performance
Displacements**

Annex C5