

Approval body for construction products
and types of construction

Bautechnisches Prüfamt

An institution established by the Federal and
Laender Governments



European Technical Assessment

ETA-10/0157
of 3 June 2015

English translation prepared by DIBt - Original version in German language

General Part

Technical Assessment Body issuing the
European Technical Assessment:

Deutsches Institut für Bautechnik

Trade name of the construction product

RCD System Stair

Product family
to which the construction product belongs

Prefabricated stair with steps and a load-bearing handrail
made of solid wood for use as an indoor stair in buildings

Manufacturer

RCD Treppensysteme GmbH & Co. KG
Holler Landstraße 56a
27798 Hude
DEUTSCHLAND

Manufacturing plant

Carstens Tischlerei GmbH & Co. KG, Werk 1 bis 99

This European Technical Assessment
contains

15 pages including 3 annexes which form an integral part
of this assessment

This European Technical Assessment is
issued in accordance with Regulation (EU)
No 305/2011, on the basis of

Guideline for European technical approval of
"Prefabricated stair kits", ETAG 008 Part 1: "Prefabricated
stair kits in general (excluding severe climatic
conditions)", January 2002,
used as European Assessment Document (EAD)
according to Article 66 Paragraph 3 of Regulation (EU)
No 305/2011.

**European Technical Assessment
ETA-10/0157**

Page 2 of 15 | 3 June 2015

English translation prepared by DIBt

The European Technical Assessment is issued by the Technical Assessment Body in its official language. Translations of this European Technical Assessment in other languages shall fully correspond to the original issued document and shall be identified as such.

Communication of this European Technical Assessment, including transmission by electronic means, shall be in full. However, partial reproduction may only be made with the written consent of the issuing Technical Assessment Body. Any partial reproduction has to be identified as such.

This European Technical Assessment may be withdrawn by the issuing Technical Assessment Body, in particular pursuant to information by the Commission according to Article 25 Paragraph 3 of Regulation (EU) No 305/2011.

Specific Part

1 Technical description of the product

The RCD System Stair is a prefabricated stair system, which consists of steps, a railing (consisting of handrail, posts and balusters), fasteners, load-bearing bolts and wall ties.

On the wall-free side the steps are connected with each other by a load-bearing bolt and via balusters with the load-bearing handrail. On the wall side each step is equipped with two wall ties which are anchored in the staircase wall. Alternatively, the staircase wall may also be replaced by a stringer or as on the wall-free side by a load-bearing handrail.

The steps, the handrail, the posts and the distance sleeves are made of solid wood (only hardwood), the balusters are made of steel or solid wood (only hardwood) and the fasteners, load-bearing bolts and wall ties are made of steel.

The product description is given in Annex A.

2 Specification of the intended use in accordance with the applicable European Assessment Document

The performances given in Section 3 are only valid if the stair is used in compliance with the specifications and conditions given in Annex B.

The verification and assessment methods on which this European Technical Assessment is based lead to the assumption of a working life of the stair of at least 50 years. The indications given on the working life cannot be interpreted as a guarantee given by the producer, but are to be regarded only as a means for choosing the right products in relation to the expected economically reasonable working life of the works.

3 Performance of the product and references to the methods used for its assessment

3.1 Mechanical resistance and stability (BWR 1)

Essential characteristic	Performance
Load-bearing capacity	See Annex C2
Load/displacement behaviour	See Annex C2
Vibration behaviour	First natural frequency: $f_1 \geq 5$ Hz (inclusive a single mass of 100 kg) Deflection under a single load $F = 1$ kN: $w \leq 5$ mm
Prevention of progressive collapse	Failure of individual components of the stair does not lead to a progressive collapse of the complete stair
Residual load-bearing capacity	Local material failure does not lead to an abrupt total loss of load-bearing capacity of the steps.
Long-term behaviour	Load-bearing capacity are ensured under an appropriate use and maintenance over the indicated working life
Resistance to earthquakes	No performance determined (NPD)
Resistance of fixings	See technical documentation of this European Technical Assessment

3.2 Safety in case of fire (BWR 2)

Essential characteristic	Performance
Reaction to fire	See Annex A5
Fire resistance	No performance determined (NPD)

3.3 Hygiene, health and the environment (BWR 3)

Regarding dangerous substances there may be requirements (e.g. transposed European legislation and national laws, regulations and administrative provisions) applicable to the products falling within the scope of this European Technical Assessment. In order to meet the provisions of Regulation (EU) No 305/2011, these requirements need also to be complied with, when and where they apply.

English translation prepared by DIBt

3.4 Safety in use (BWR 4)

Essential characteristic	Performance
Geometry	See Annex C1
Slipperiness	No performance determined (NPD)
Equipment of the stair for a safe use	Barrier and handrail are components of the stair (see Annex C1) Vertical balusters, arranged between step and handrail, are used as fill-in elements. Thereby climb ability for infants will not be supported Tactility and visibility: No performance determined (NPD)
Safe breakage of components	No brittle failure of individual components
Impact resistance	No performance determined (NPD)

3.5 Protection against noise (BWR 5)

Not applicable.

3.6 Energy economy and heat retention (BWR 6)

Not applicable.

3.7 Sustainable use of natural resources (BWR 7)

The sustainable use of natural resources was not investigated.

3.8 General aspects

Essential characteristic	Performance
Resistance to deterioration caused by physical, chemical and biological agents	Adequate resistance for the intended use under an appropriate use and maintenance
Finishes and surface layers	Components made of solid wood can be coated with varnish on all sides or they are oiled

English translation prepared by DIBt

4 Assessment and verification of constancy of performance (AVCP) system applied, with reference to its legal base

According to Decision of the Commission of 3 February 1999 (99/89/EC) (OJ L 029 of 25.01.1999 p. 34-37)) the system of assessment and verification of constancy of performance (see Annex V and Article 65 Paragraph 2 to Regulation (EU) No 305/2011) given in the following table applies.

Product	Intended use	Level or class	System
Prefabricated stair kits	For dwellings and other buildings	-	2+

Additional according to Decision of the Commission of 8 January 2001 (2001/596/EC) (OJ L 209 of 02.08.2001 p. 33-42) the system of assessment and verification of constancy of performance (see Annex V and Article 65 Paragraph 2 to Regulation (EU) No 305/2011) given in the following table applies.

Product	Intended use	Level or class	System
Prefabricated stair kits	For uses subject to regulations on reaction to fire	According to Annex A5, Table 1	4

5 Technical details necessary for the implementation of the AVCP system, as provided for in the applicable European Assessment Document

Technical details necessary for the implementation of the AVCP system are laid down in the control plan deposited at Deutsches Institut für Bautechnik.

Issued in Berlin on 3 June 2015 by Deutsches Institut für Bautechnik

Uwe Bender
Head of Department

beglaubigt:
Wittstock

Types of plan

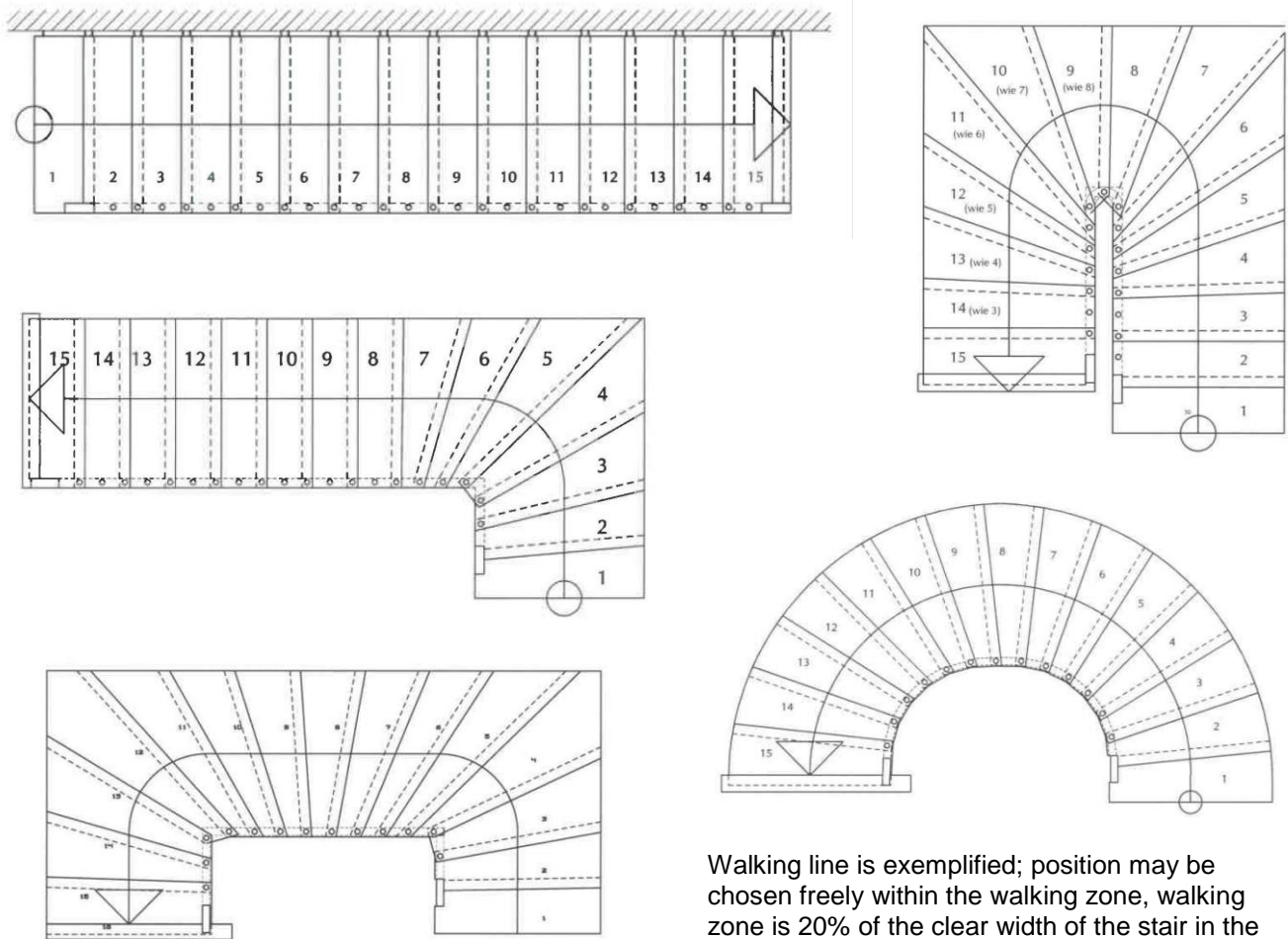

Walking line is exemplified; position may be chosen freely within the walking zone, walking zone is 20% of the clear width of the stair in the middle of the stair

Construction

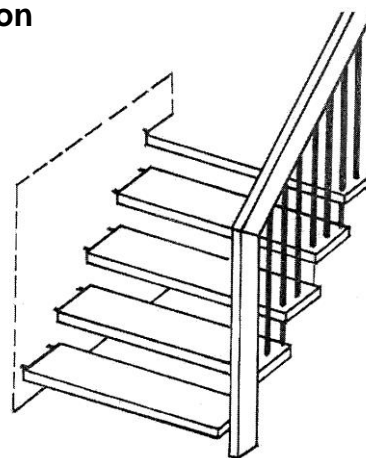

RCD System Stair

Product and intended use

Annex A1

Wall ties (possible types)

Masonry / Concrete

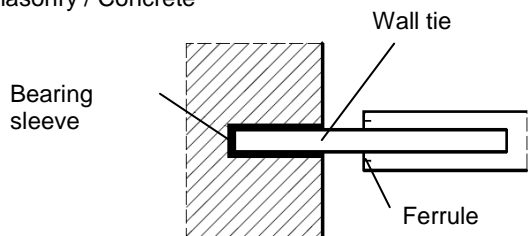

minimum wall thickness and minimum strength of wall materials according to the technical documentation

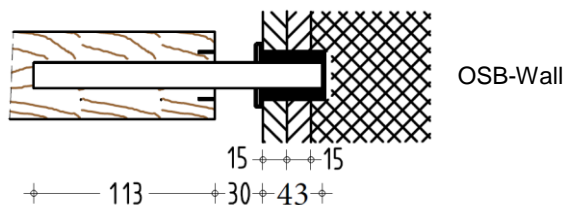

Baluster System

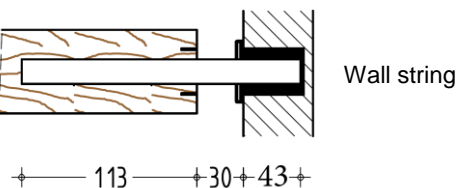
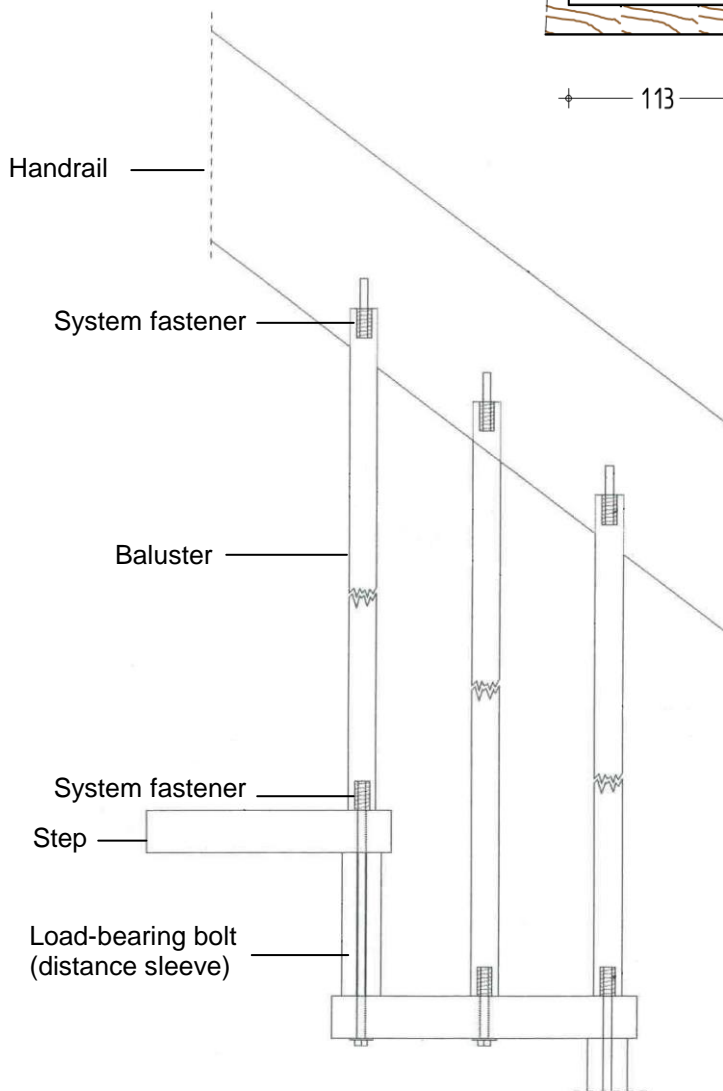

more details according to the technical documentation

RCD System Stair

Baluster system, wall ties

Annex A2

Handrail-corner joint (possible types)

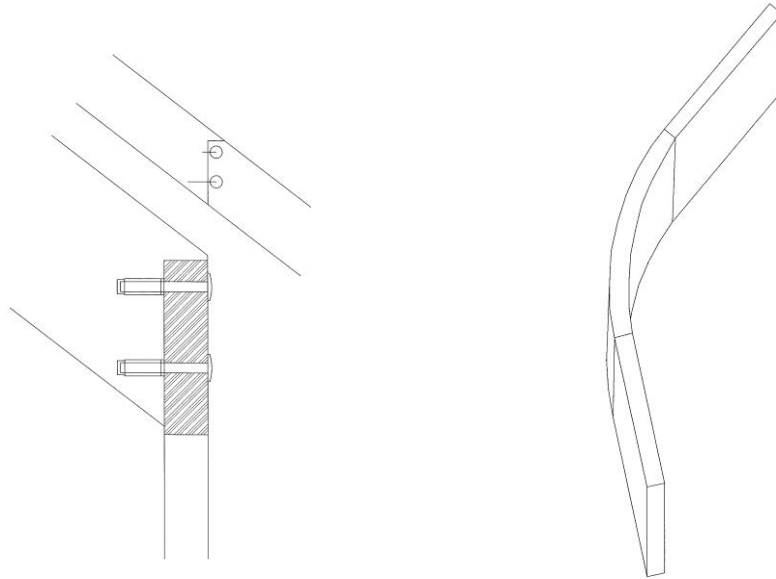

Post-handrail joint (possible types)

screwed

finger jointed

solid wood
fastener

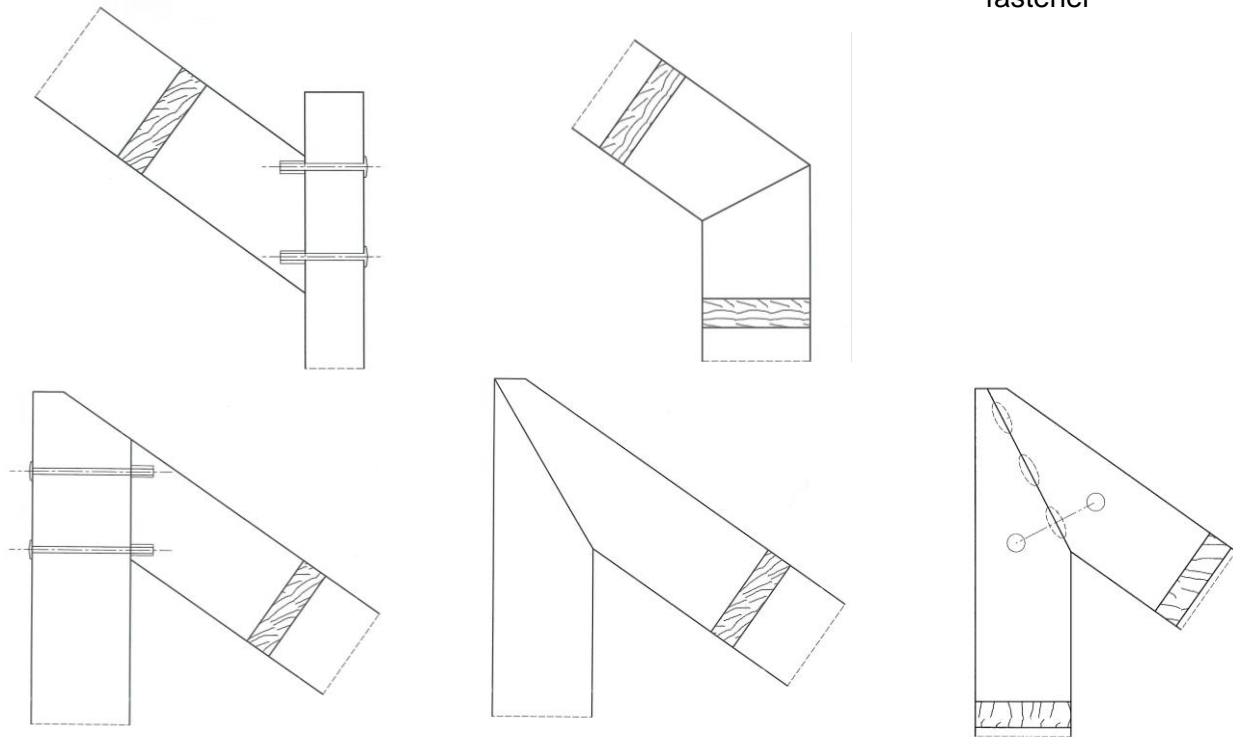

more details according to the technical documentation

RCD System Stair

Handrail-corner joint, Post-handrail joint

Annex A3

Post joint at bottom

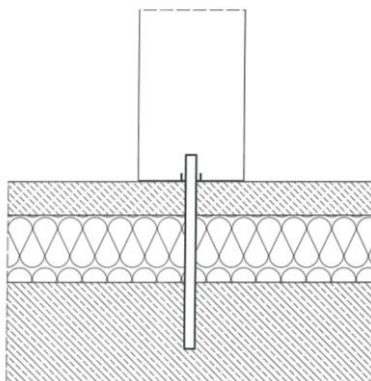

Post joint at the top (possible types)

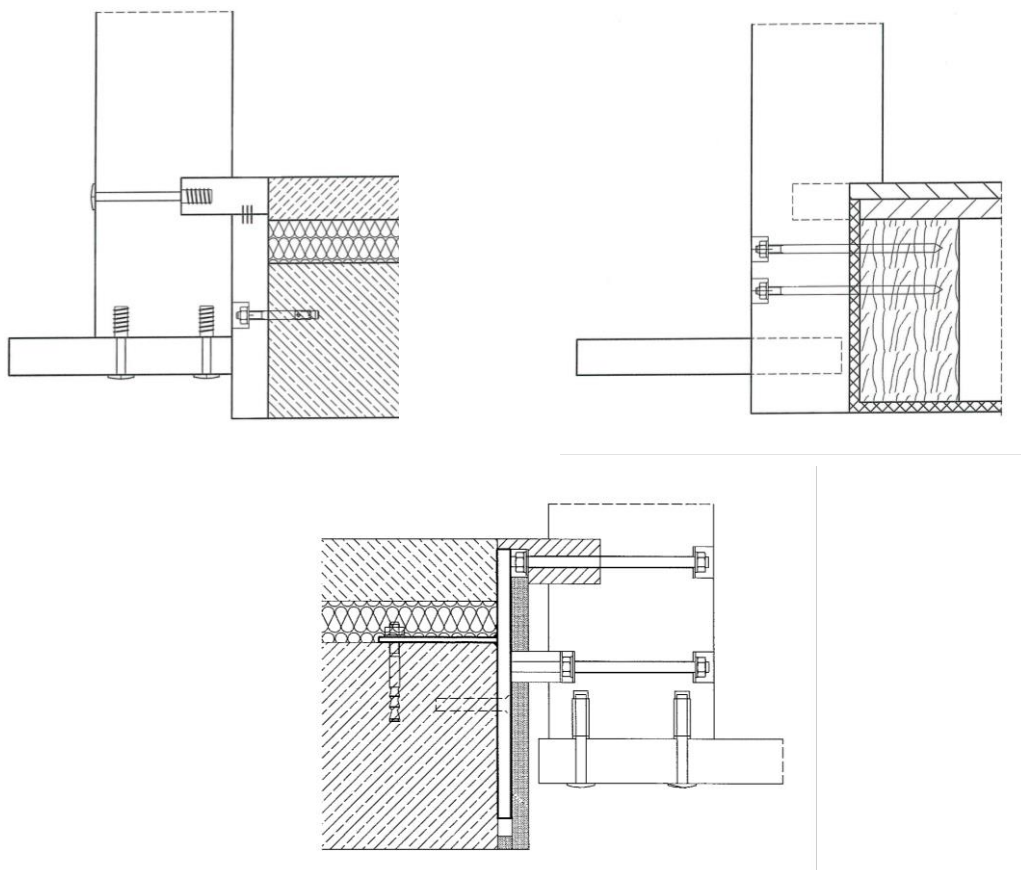

more details according to the technical documentation,
horizontal support of the handrail at the top perpendicular to the direction of the walking line

RCD System Stair

Post joint bottom, post joint at the top

Annex A4

Table 1: Components of stair: minimum dimensions and materials

Component of stair	Material ¹⁾	Dimension		Value	Reaction to fire ³⁾
Step	solid wood ²⁾	thickness	[mm]	43	D-s2, d0 (2003/593/EC)
Upper flange of the railing (handrail)	solid wood ²⁾	height / width	[mm]	160 / 43 ⁴⁾	D-s2, d0 (2003/593/EC)
Post	solid wood ²⁾	height / width	[mm]	160 / 43 or 90 / 90	D-s2, d0 (2003/593/EC)
Baluster	solid wood ²⁾	diameter	[mm]	30	D-s2, d0 (2003/593/EC)
	steel	diameter	[mm]	16	A1 (96/603/EC)
Load-bearing bolt / system fastener	steel	diameter	[mm]	10	A1 (96/603/EC)
Distance sleeve (load- bearing bolt)	solid wood ²⁾	diameter	[mm]	40 (30) ⁷⁾	D-s2, d0 (2003/593/EC)
	steel pipe	diameter / wall thickness	[mm]	16 / 1.6 ⁵⁾	A1 (96/603/EC)
Wall tie	round steel	diameter	[mm]	16	A1 (96/603/EC)
		embedment depth wall	[mm]	65 ⁶⁾	
		embedment depth step	[mm]	105 ⁶⁾	
Bearing sleeve (wall tie)	plastic	diameter	[mm]	25	Not relevant

- 1) characteristic values of material according to technical documentation
 2) only hardwood of the following species: beech, oak, maple, ash
 3) according to the provisions of EC decisions
 4) handrail of straight flights is horizontal fixed in height of the floor slab
 5) with socket
 6) for OSB-wall and wall string see Annex A2
 7) value in brackets: with additional washer with diameter 40 mm

RCD System Stair

Components of stair: minimum dimensions and reaction to fire

Annex A5

Specification of intended use (Part 1)

Intended use:

- European Technical Assessment applies for a construction system.
- For the specific case of use the corresponding type of stair is manufactured within the context of the values defined in this European Technical Assessment.
- Values of this ETA apply to all types of stairs, the real dimensions follow in accordance with the relevant case of use.

Stair subject to:

- Static and quasi static loads

Use conditions:

- Indoor stair
- Air temperatures between +5 °C and +30 °C
- Relative air humidity between 30% and 70%

Design:

- Design of the stair according to the annexes and the technical documentation of this European Technical Assessment.
- Fastening of the stair to the construction works according to the annexes and the technical documentation of this Technical European Assessment.
- Verification of the transmission of loads to the construction works by the civil engineer responsible for the construction works.
- Load bearing capacity at ultimate limit state:

$$q_k \cdot \gamma_Q \leq q_{RK} / \gamma_M$$

$$Q_k \cdot \gamma_Q \leq Q_{RK} / \gamma_M$$

$$h_k \cdot \gamma_Q \cdot \psi_0 \leq h_{RK} / \gamma_M$$

with

q_{RK}, Q_{RK}, h_{RK} : characteristic values of resistance; see Table 3

γ_M : recommended material partial safety factor; see Table 3

q_k, Q_k, h_k : characteristic values of imposed loads according to EN 1991-1-1:2010-12

$\gamma_Q = 1.5$: recommended partial safety factor, in absence of other national regulations

$\psi_0 = 0.7$: recommended combination factor, in absence of other national regulations

- Maximum characteristic values of imposed loads under consideration of the partial factors mentioned above; see Table 5

RCD System Stair

Specification of intended use (Part 1)

Annex B1

Specification of intended use (Part 2)

Installation:

- Installation by personal appropriately trained and authorized by the holder of the approval by means of the technical documentation of this European Technical Assessment
- Installation only in the way as specified in the technical documentation of this European Technical Assessment
- Installation of timber components when moisture content of timber components is $8 \pm 2 \%$
- Sufficient support of the stair when assembling
- Installation of stair components without imposed deformations
- Installation of stair components without significant defects and cracks
- Replacing of stair components, which begin tearing when assembling
- Bolted connection are protected such that they will not be loosened by vibrations

Indication of the manufacturer:

- Ensure that all persons involved will be appropriately informed about the specific conditions according to sections 1 and 2 (including the annexes to which reference is being made as well as the not confidential parts of the technical documentation deposited to this European Technical Assessment)
- Packaging of timber components such that the wood moisture is $8 \pm 2 \%$ during transport and storage
- Instructions for use should provide information as to use, maintenance and repair of the stair. Including the information of avoidance of moisture penetration of the timber components and of retightens the bolting of the load-bearing bolts and connections according to Annexes A2 to A4 after the first heating season

electronic copy of the eta by dibt: eta-10/0157

RCD System Stair	Annex B2
Specification of intended use (Part 2)	

Table 2: Geometry

Designation			Dimension	
			minimum	maximum
going	step on walking line ¹⁾	[mm]	210	370 ²⁾
	tapered step	[mm]	60 ^{2) 3)}	540 ^{2) 4)}
rise of the stairs ¹⁾			140 ²⁾	210
pitch of the walking line ¹⁾			21	45
overlap of steps	wall side	[mm]	30	- ⁵⁾
	wall-free side	[mm]	60	- ⁵⁾
number of rises			3	16
openings	between barrier and other parts of the stair	[mm]	0	0
	between stairs and wall	[mm]	- ⁵⁾	30
	between consecutive steps	[mm]	- ⁵⁾	167
	between balusters	[mm]	40	130
clear width of stairs			500	1000
minimum headroom			- ⁵⁾	
length of the flight			- ⁵⁾	4050
thickness of steps			43	- ⁵⁾
height of the railing (barrier) / handrail			900	900
handrail	width	[mm]	43	- ⁵⁾
	height	[mm]	160	- ⁵⁾
	clear distance to adjacent components	[mm]	50	- ⁵⁾

- 1) values are constant within one flight
- 2) tolerance between nominal value and actual value = ± 5 mm
- 3) inside of tapered step
- 4) outside of tapered step
- 5) not relevant

- 1 going
- 2 rise
- 3 overlap
- 4 opening between consecutive steps
- 5 length of the flight
- 6 thickness of steps
- 7 height of the railing / barrier
- 8 opening between balusters

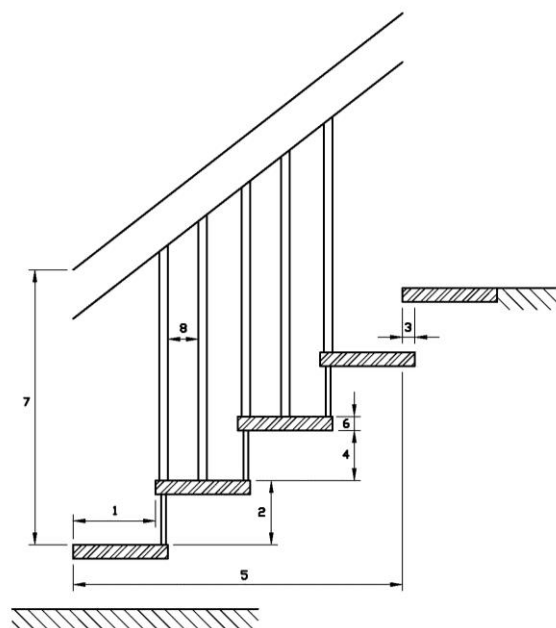

RCD System Stair

Geometry of the stair

Annex C1

Table 3: Load-bearing capacity - Characteristic values of resistance

Type of loading	Characteristic values of resistance			γ_M ¹⁾
vertical variable uniformly distributed load	q_{Rk}	[kN/m ²]	6.8	1.5
vertical variable single load	Q_{Rk}	[kN]	4.5	
horizontal variable uniformly distributed load on barrier	h_{Rk}	[kN/m]	0.8	

¹⁾ Recommended partial safety factor, in absence of other national regulations

Table 4: Deflections under loading

Deflection of the flight under uniformly distributed load			
uniformly distributed load	q_k	[kN/m ²]	3.5
length of the median line of the flight	L	[mm]	4050
deflection under load F_S related to the median line of the flight	w	[-]	$\leq L/200$
Deflection of the step under single point load			
single load	Q_k	[kN]	2.0
clear width of the stair	L	[mm]	1000
deflection under load F_S related to the clear width of the stair	w	[-]	$\leq L/200$

Table 5: Imposed loads

Type of loading	Imposed loads		
vertical variable uniformly distributed load	q	[kN/m ²]	3.0
vertical variable single load	Q	[kN]	2.0
horizontal variable uniformly distributed load on barrier	h	[kN/m]	0.5

RCD System Stair

Load-bearing capacity – Characteristic values of resistance,
Deflections under loading,
Imposed loads

Annex C2