

Approval body for construction products
and types of construction

Bautechnisches Prüfamt

An institution established by the Federal and
Laender Governments



European Technical Assessment

ETA-11/0493
of 15 April 2015

English translation prepared by DIBt - Original version in German language

General Part

Technical Assessment Body issuing the
European Technical Assessment:

Deutsches Institut für Bautechnik

Trade name of the construction product

Injection system Hilti HIT-HY 200-A

Product family
to which the construction product belongs

Bonded anchor with threaded rods, rebar, internal
threaded sleeves and Hilti tension anchor HZA for use in
concrete

Manufacturer

Hilti Aktiengesellschaft
9494 SCHAAN
FÜRSTENTUM LIECHTENSTEIN

Manufacturing plant

Hilti Werke

This European Technical Assessment
contains

33 pages including 3 annexes

This European Technical Assessment is
issued in accordance with Regulation (EU)
No 305/2011, on the basis of

Guideline for European technical approval of "Metal
anchors for use in concrete", ETAG 001 Part 5: "Bonded
anchors", April 2013,
used as European Assessment Document (EAD)
according to Article 66 Paragraph 3 of Regulation (EU)
No 305/2011.

The European Technical Assessment is issued by the Technical Assessment Body in its official language. Translations of this European Technical Assessment in other languages shall fully correspond to the original issued document and shall be identified as such.

Communication of this European Technical Assessment, including transmission by electronic means, shall be in full. However, partial reproduction may only be made with the written consent of the issuing Technical Assessment Body. Any partial reproduction has to be identified as such.

This European Technical Assessment may be withdrawn by the issuing Technical Assessment Body, in particular pursuant to information by the Commission according to Article 25 Paragraph 3 of Regulation (EU) No 305/2011.

Specific Part

1 Technical description of the product

The Injection system Hilti HIT-HY 200-A is a bonded anchor consisting of a foil pack with injection mortar Hilti HIT-HY 200-A and a steel element. The steel element consist of

- a threaded rod HIT-V or a commercial threaded rod with washer and hexagon nut in the range of M8 to M30 or
- an internal threaded sleeve HIS-(R)N in the range of M8 to M20 or
- Hilti tension anchor HZA M12 to M27
- Hilti tension anchor HZA-R M12 to M24 or
- Reinforcing bar (rebar) of sizes $\phi = 8$ to 32 mm.

The steel element is placed into a drilled hole filled with injection mortar and is anchored via the bond between metal part, injection mortar and concrete.

The product description is given in Annex A.

2 Specification of the intended use in accordance with the applicable European Assessment Document

The performances given in Section 3 are only valid if the anchor is used in compliance with the specifications and conditions given in Annex B.

The verifications and assessment methods on which this European Technical Assessment is based lead to the assumption of a working life of the anchor of at least 50 years. The indications given on the working life cannot be interpreted as a guarantee given by the producer, but are to be regarded only as a means for choosing the right products in relation to the expected economically reasonable working life of the works.

3 Performance of the product and references to the methods used for its assessment

3.1 Mechanical resistance and stability (BWR 1)

Essential characteristic	Performance
Characteristic resistance under static and quasi-static action for design according to TR 029, displacements	See Annex C1 to C12
Characteristic resistance for seismic performance category C1 for design according to TR 045, displacements	See Annex C13 to C15

3.2 Safety in case of fire (BWR 2)

Essential characteristic	Performance
Reaction to fire	Anchorage satisfy requirements for Class A1
Resistance to fire	No performance determined (NPD)

English translation prepared by DIBt

3.3 Hygiene, health and the environment (BWR 3)

Regarding dangerous substances there may be requirements (e.g. transposed European legislation and national laws, regulations and administrative provisions) applicable to the products falling within the scope of this European Technical Assessment. In order to meet the provisions of Regulation (EU) No 305/2011, these requirements need also to be complied with, when and where they apply.

3.4 Safety in use (BWR 4)

The essential characteristics regarding Safety in use are included under the Basic Works Requirement Mechanical resistance and stability.

3.5 Protection against noise (BWR 5)

Not applicable.

3.6 Energy economy and heat retention (BWR 6)

Not applicable.

3.7 Sustainable use of natural resources (BWR 7)

The sustainable use of natural resources was not investigated.

3.8 General aspects

The verification of durability is part of testing the essential characteristics. Durability is only ensured if the specifications of intended use according to Annex B are taken into account.

4 Assessment and verification of constancy of performance (AVCP) system applied, with reference to its legal base

According to Decision of the Commission of 24 June 1996 (96/582/EC) (OJ L 254 of 08.10.96 p. 62-65), the system of assessment and verification of constancy of performance (see Annex V and Article 65 Paragraph 2 to Regulation (EU) No 305/2011) given in the following table applies.

Product	Intended use	Level or class	System
Metal anchors for use in concrete (heavy-duty type)	For fixing and/or supporting concrete structural elements or heavy units such as cladding and suspended ceilings	—	1

5 Technical details necessary for the implementation of the AVCP system, as provided for in the applicable European Assessment Document

Technical details necessary for the implementation of the AVCP system are laid down in the control plan deposited at Deutsches Institut für Bautechnik.

Issued in Berlin on 15 April 2015 by Deutsches Institut für Bautechnik

Uwe Bender
Head of Department

beglaubigt:
Lange

Installed condition

Figure A1:
Threaded rod and HIT-V-...

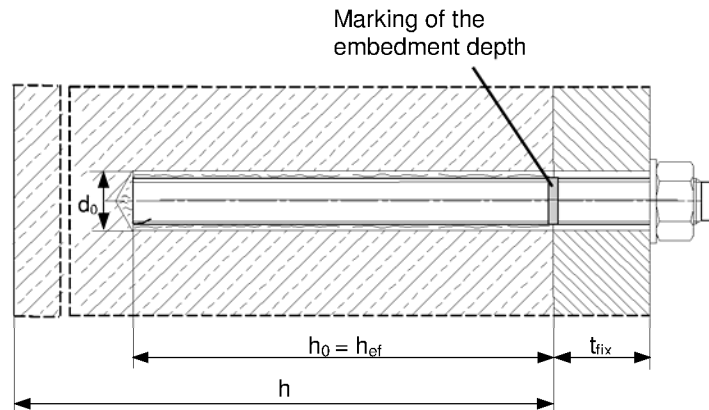

Figure A2:
Internally threaded sleeve HIS-(R)N

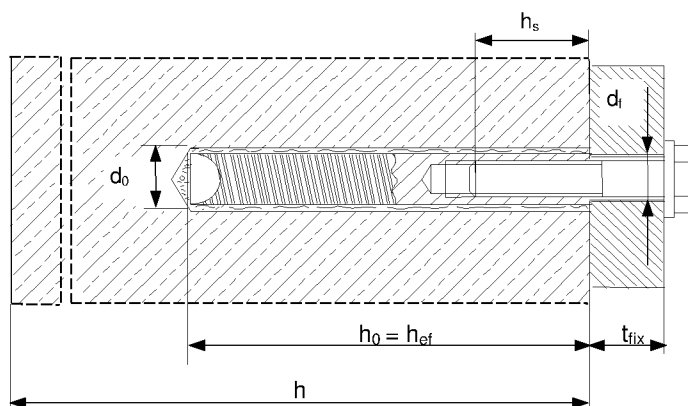
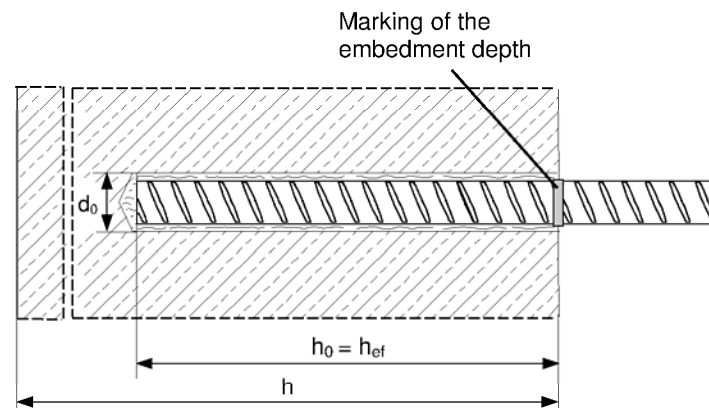

Figure A3:
Reinforcing bar



Injection System Hilti HIT-HY 200-A

Product description
Installed condition

Annex A1

Product description: Injection mortar and steel elements

Injection mortar Hilti HIT-HY 200-A: hybrid system with aggregate
330 ml and 500 ml

Marking:
HILTI-HIT
Production number and
production line
Expiry date mm/yyyy



Product name: "Hilti HIT-HY 200-A"

Static mixer Hilti HIT-RE-M



Steel elements

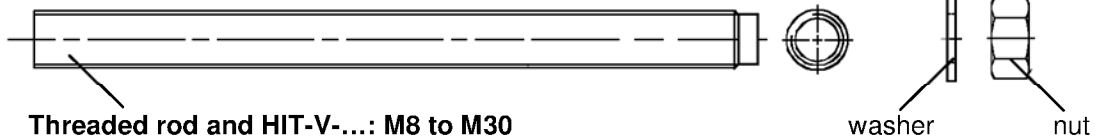

Threaded rod and HIT-V-...: M8 to M30

Commercial standard threaded rod:

- Materials and mechanical properties according to Table A1.
- Inspection certificate 3.1 according to EN 10204:2004. The document shall be stored.
- Marking of embedment depth.

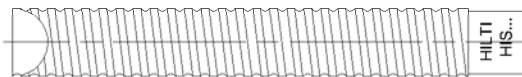

Internally threaded sleeve: HIS-(R)N M8 to M20

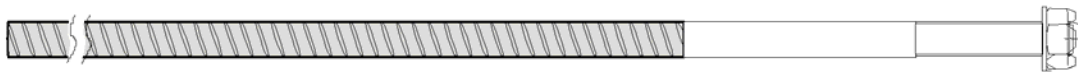

Hilti Tension Anchor: HZA M12 to M27 and HZA-R M12 to M24

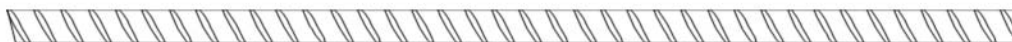

Reinforcing bar (rebar): ϕ 8 to ϕ 32

- Materials and mechanical properties according to Table A1
- Dimensions according to Annex B6

Injection System Hilti HIT-HY 200-A

Product description

Injection mortar / Static mixer / Steel elements

Annex A2

Table A1: Materials

Designation	Material
Reinforcing bars	
Rebar: EN 1992-1-1: 2004 and AC:2010, Annex C	Bars and de-coiled rods class B or C with f_{yk} and k according to NDP or NCL of EN 1992-1-1/NA:2013 $f_{uk} = f_{tk} = k \cdot f_{yk}$
Metal parts made of zinc coated steel	
Threaded rod, HIT-V-5.8(F)	Strength class 5.8, $f_{uk} = 500 \text{ N/mm}^2$, $f_{yk} = 400 \text{ N/mm}^2$, Elongation at fracture ($l_0=5d$) > 8% ductile Electroplated zinc coated $\geq 5 \mu\text{m}$, (F) hot dip galvanized $\geq 45 \mu\text{m}$
Threaded rod, HIT-V-8.8(F)	Strength class 8.8, $f_{uk} = 800 \text{ N/mm}^2$, $f_{yk} = 640 \text{ N/mm}^2$, Elongation at fracture ($l_0=5d$) > 8% ductile Electroplated zinc coated $\geq 5 \mu\text{m}$, (F) hot dip galvanized $\geq 45 \mu\text{m}$
Hilti tension anchor HZA	Round steel with threaded part: electroplated zinc coated $\geq 5 \mu\text{m}$ Rebar: Bars class B according to NDP or NCL of EN 1992-1-1/NA:2013
Internally threaded sleeve HIS-N	Electroplated zinc coated $\geq 5 \mu\text{m}$
Washer	Electroplated zinc coated $\geq 5 \mu\text{m}$, hot dip galvanized $\geq 45 \mu\text{m}$
Nut	Strength class of nut adapted to strength class of threaded rod Electroplated zinc coated $\geq 5 \mu\text{m}$, hot dip galvanized $\geq 45 \mu\text{m}$
Metal parts made of stainless steel	
Threaded rod, HIT-V-R	For $\leq \text{M24}$: strength class 70, $f_{uk} = 700 \text{ N/mm}^2$, $f_{yk} = 450 \text{ N/mm}^2$; For $> \text{M24}$: strength class 50, $f_{uk} = 500 \text{ N/mm}^2$, $f_{yk} = 210 \text{ N/mm}^2$; Elongation at fracture ($l_0=5d$) > 8% ductile Stainless steel 1.4401, 1.4404, 1.4578, 1.4571, 1.4439, 1.4362 EN 10088-1:2014
Hilti tension anchor HZA-R	Round steel with threaded part: Stainless steel 1.4404, 1.4362, 1.4571 EN 10088-1:2014 Rebar: Bars class B according to NDP or NCL of EN 1992-1-1/NA:2013
Internally threaded sleeve HIS-RN	Stainless steel 1.4401, 1.4571 EN 10088-1:2014
Washer	Stainless steel 1.4401, 1.4404, 1.4578, 1.4571, 1.4439, 1.4362 EN 10088-1:2014
Nut	Strength class of nut adapted to strength class of threaded rod Stainless steel 1.4401, 1.4404, 1.4578, 1.4571, 1.4439, 1.4362 EN 10088-1:2014
Metal parts made of high corrosion resistant steel	
Threaded rod HIT-V-HCR	For $\leq \text{M20}$: $f_{uk} = 800 \text{ N/mm}^2$, $f_{yk} = 640 \text{ N/mm}^2$, For $> \text{M20}$: $f_{uk} = 700 \text{ N/mm}^2$, $f_{yk} = 400 \text{ N/mm}^2$, Elongation at fracture ($l_0=5d$) > 8% ductile High corrosion resistant steel 1.4529, 1.4565 EN 10088-1:2014
Washer	High corrosion resistant steel 1.4529, 1.4565 EN 10088-1:2014
Nut	Strength class of nut adapted to strength class of threaded rod High corrosion resistant steel 1.4529, 1.4565 EN 10088-1:2014

Injection System Hilti HIT-HY 200-A

Product description
Materials

Annex A3

Specifications of intended use

Anchorage subject to:

- Static and quasi static loading
- Seismic performance category C1: HIT-V, rebar, HZA-R, (not HIS-N)





Base material:

- Reinforced or unreinforced normal weight concrete according to EN 206:2013.
- Strength classes C20/25 to C50/60 according to EN 206:2013.
- Cracked and non-cracked concrete.

Temperature in the base material:

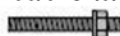
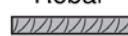
- **at installation**
-10 °C to +40 °C
- **in-service**
Temperature range I: -40 °C to +40 °C
(max. long term temperature +24 °C and max. short time temperature +40 °C)
Temperature range II: -40 °C to +80 °C
(max. long term temperature +50 °C and max. short time temperature +80 °C)
Temperature range III: -40 °C to +120 °C
(max. long term temperature +72 °C and max. short time temperature +120 °C)

Table B1: Specifications of intended use

Elements	HIT-HY 200-A with ...			
	HIT-V ... 	Rebar 	HZA(-R) 	HIS-(R)N 
Hammer drilling with hollow drill bit TE-CD or TE-YD 	✓	✓	✓	✓
Hammer drilling 	✓	✓	✓	✓
Static and quasi static loading in cracked and non-cracked concrete	M8 to M30	φ 8 to φ 32	M12 to M27	M8 to M20
Seismic performance category C1	M10 to M30	φ 10 to φ 32	M12 to M27	-

Injection System Hilti HIT-HY 200-A

Intended Use
Specifications

Annex B1

Use conditions (Environmental conditions):

- Structures subject to dry internal conditions (zinc coated steel, stainless steel or high corrosion resistant steel).
- Structures subject to external atmospheric exposure (including industrial and marine environment) and to permanently damp internal conditions, if no particular aggressive conditions exist (stainless steel or high corrosion resistant steel).
- Structures subject to external atmospheric exposure and to permanently damp internal conditions, if other particular aggressive conditions exist (high corrosion resistant steel).

Note: Particular aggressive conditions are e.g. permanent, alternating immersion in seawater or the splash zone of seawater, chloride atmosphere of indoor swimming pools or atmosphere with extreme chemical pollution (e.g. in desulphurization plants or road tunnels where de-icing products are used).

Design:

- Anchorages are designed under the responsibility of an engineer experienced in anchorages and concrete work.
- Verifiable calculation notes and drawings are prepared taking account of the loads to be anchored. The position of the anchor is indicated on the design drawings (e. g. position of the anchor relative to reinforcement or to supports, etc.).
- Anchorages under static or quasi-static loading are designed in accordance with:
“EOTA Technical Report TR 029, Edition September 2010”
- Anchorages under seismic actions (cracked concrete) are designed in accordance with:
“EOTA Technical Report TR 045, Edition February 2013”

Anchorages shall be positioned outside of critical regions (e.g. plastic hinges) of the concrete structure. Fastenings in stand-off installation or with a grout layer under seismic action are not covered in this European technical assessment (ETA).

Installation:

- Use category: dry or wet concrete (not in flooded holes)
- Overhead installation is admissible
- Anchor installation carried out by appropriately qualified personnel and under the supervision of the person responsible for technical matters of the site.

Injection System Hilti HIT-HY 200-A	Annex B2
Intended Use Specifications	

Table B2: Installation parameters of threaded rod and HIT-V-...

Threaded rod and HIT-V-...	M8	M10	M12	M16	M20	M24	M27	M30
Diameter of element d [mm]	8	10	12	16	20	24	27	30
Nominal diameter of drill bit d_0 [mm]	10	12	14	18	22	28	30	35
Effective embedment depth and drill hole depth $h_{ef} = h_0$ [mm]	60 to 160	60 to 200	70 to 240	80 to 320	90 to 400	96 to 480	108 to 540	120 to 600
Maximum diameter of clearance hole in the fixture ¹⁾ d_f [mm]	9	12	14	18	22	26	30	33
Minimum thickness of concrete member h_{min} [mm]	$h_{ef} + 30$ ≥ 100 mm			$h_{ef} + 2 \cdot d_0$				
Maximum torque moment T_{max} [Nm]	10	20	40	80	150	200	270	300
Minimum spacing s_{min} [mm]	40	50	60	75	90	115	120	140
Minimum edge distance c_{min} [mm]	40	45	45	50	55	60	75	80

¹⁾ for larger clearance hole see "TR 029 section 1.1"

HIT-V-...

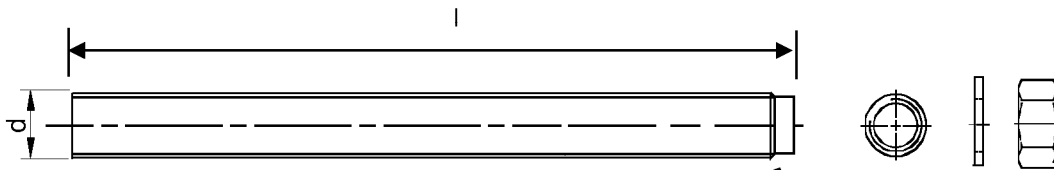

Marking:

- 5.8 - l = HIT-V-5.8 M...x l
- 5.8F - l = HIT-V-5.8F M...x l
- 8.8 - l = HIT-V-8.8 M...x l
- 8.8F - l = HIT-V-8.8F M...x l
- R - l = HIT-V-R M ...x l
- HCR - l = HIT-V-HCR M ...x l

Injection System Hilti HIT-HY 200-A

Intended Use

Installation parameters of threaded rod and HIT-V-...

Annex B3

Table B3: Installation parameters of internally threaded sleeve HIS-(R)N

Internally threaded sleeve HIS-(R)N...	M8	M10	M12	M16	M20
Outer diameter of sleeve d [mm]	12,5	16,5	20,5	25,4	27,6
Nominal diameter of drill bit d_0 [mm]	14	18	22	28	32
Effective embedment depth and drill hole depth $h_{ef} = h_0$ [mm]	90	110	125	170	205
Maximum diameter of clearance hole in the fixture ¹⁾ d_f [mm]	9	12	14	18	22
Minimum thickness of concrete member h_{min} [mm]	120	150	170	230	270
Maximum torque moment T_{max} [Nm]	10	20	40	80	150
Thread engagement length min-max h_s [mm]	8-20	10-25	12-30	16-40	20-50
Minimum spacing s_{min} [mm]	60	75	90	115	130
Minimum edge distance c_{min} [mm]	40	45	55	65	90

¹⁾ for larger clearance hole see "TR 029 section 1.1"

Internally threaded sleeve HIS-(R)N...

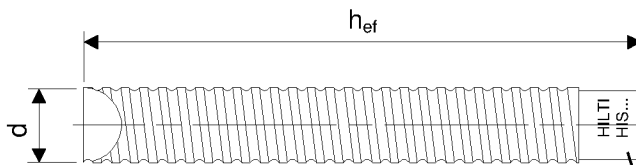

Marking:
Identifying mark - HILTI and
embossing "HIS-N" (for C-steel)
embossing "HIS-RN" (for stainless steel)

Injection System Hilti HIT-HY 200-A

Intended Use

Installation parameters of internally threaded sleeve HIS-(R)N

Annex B4

Table B4: Installation parameters of Hilti tension anchor HZA-R

Hilti tension anchor HZA-R ...			M12	M16	M20	M24
Rebar diameter	ϕ	[mm]	12	16	20	25
Nominal embedment depth and drill hole depth	$h_{nom} = h_0$	[mm]	170 to 240	180 to 320	190 to 400	200 to 500
Effective embedment depth ($h_{ef} = h_{nom} - l_e$)	h_{ef}	[mm]	$h_{nom} - 100$			
Length of smooth shaft	l_e	[mm]	100			
Nominal diameter of drill bit	d_0	[mm]	16	20	25	32
Maximum diameter of clearance hole in the fixture ¹⁾	d_f	[mm]	14	18	22	26
Maximum torque moment	T_{max}	[Nm]	40	80	150	200
Minimum thickness of concrete member	h_{min}	[mm]	$h_{nom} + 2 \cdot d_0$			
Minimum spacing	s_{min}	[mm]	65	80	100	130
Minimum edge distance	c_{min}	[mm]	45	50	55	60

¹⁾ for larger clearance hole see "TR 029 section 1.1"

Table B5: Installation parameters of Hilti tension anchor HZA

Hilti tension anchor HZA...			M12	M16	M20	M24	M27
Rebar diameter	ϕ	[mm]	12	16	20	25	28
Nominal embedment depth and drill hole depth	$h_{nom} = h_0$	[mm]	90 to 240	100 to 320	110 to 400	120 to 500	140 to 560
Effective embedment depth ($h_{ef} = h_{nom} - l_e$)	h_{ef}	[mm]	$h_{nom} - 20$				
Length of smooth shaft	l_e	[mm]	20				
Nominal diameter of drill bit	d_0	[mm]	16	20	25	32	35
Maximum diameter of clearance hole in the fixture ¹⁾	d_f	[mm]	14	18	22	26	30
Maximum torque moment	T_{max}	[Nm]	40	80	150	200	270
Minimum thickness of concrete member	h_{min}	[mm]	$h_{nom} + 2 \cdot d_0$				
Minimum spacing	s_{min}	[mm]	65	80	100	130	140
Minimum edge distance	c_{min}	[mm]	45	50	55	60	75

¹⁾ for larger clearance hole see "TR 029 section 1.1"

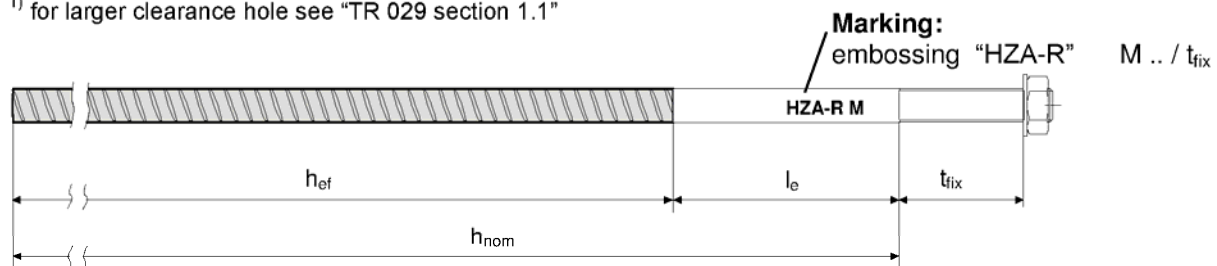

Injection System Hilti HIT-HY 200-A

Intended Use

Installation parameters of Hilti tension anchor HZA-(R)

Annex B5

Table B6: Installation parameters of reinforcing bar

Reinforcing bar (rebar)	ϕ 8	ϕ 10	ϕ 12	ϕ 14	ϕ 16	ϕ 20	ϕ 25	ϕ 26	ϕ 28	ϕ 30	ϕ 32
Diameter ϕ [mm]	8	10	12	14	16	20	25	26	28	30	32
Effective embedment depth and drill hole depth $h_{ef} = h_0$ [mm]	60 to 160	60 to 200	70 to 240	75 to 280	80 to 320	90 to 400	100 to 500	104 to 520	112 to 560	120 to 600	128 to 640
Nominal diameter of drill bit d_0 [mm]	10 / 12 ¹⁾	12 / 14 ¹⁾	14 ¹⁾ / 16 ¹⁾	18	20	25	32	32	35	37	40
Minimum thickness of concrete member h_{min} [mm]	$h_{ef} + 30$ ≥ 100 mm			$h_{ef} + 2 \cdot d_0$							
Minimum spacing s_{min} [mm]	40	50	60	70	80	100	125	130	140	150	160
Minimum edge distance c_{min} [mm]	40	45	45	50	50	65	70	75	75	80	80

¹⁾ Each of the two given values can be used.

Reinforcing bar



For rebar bolt

- Minimum value of related rip area $f_{R,min}$ according to EN 1992-1-1:2004+AC:2010
- Rib height of the bar h_{rib} shall be in the range $0,05 \cdot \phi \leq h_{rib} \leq 0,07 \cdot \phi$
(ϕ : Nominal diameter of the bar; h_{rib} : Rip height of the bar)

Injection System Hilti HIT-HY 200-A

Intended Use
Installation parameters of reinforcing bar (rebar)

Annex B6

Table B7: Maximum working time and minimum curing time







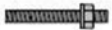

Temperature in the base material T	Maximum working time t_{work}	Minimum curing time t_{cure}
-10 °C to -5 °C	1,5 hours	7 hours
> -5 °C to 0 °C	50 min	4 hours
> 0 °C to 5 °C	25 min	2 hours
> 5 °C to 10 °C	15 min	75 min
> 10 °C to 20 °C	7 min	45 min
> 20 °C to 30 °C	4 min	30 min
> 30 °C to 40 °C	3 min	30 min

Injection System Hilti HIT-HY 200-A

Intended Use
Maximum working time and minimum curing time

Annex B7

Table B8: Parameters of cleaning and setting tools

Elements				Drill and clean		Installation	
HIT-V-...	HIS-(R)N	Rebar	HZA(-R)	Hammer drilling	hollow drill bit	Brush	Piston plug
							
size	size	size	size	d ₀ [mm]	d ₀ [mm]	HIT-RB	HIT-SZ
M8	-	φ8	-	10	-	10	-
M10	-	φ8 / φ10	-	12	12	12	12
M12	M8	φ10 / φ12	-	14	14	14	14
-	-	φ12	M12	16	16	16	16
M16	M10	φ14	-	18	18	18	18
-	-	φ16	M16	20	20	20	20
M20	M12	-	-	22	22	22	22
-	-	φ20	M20	25	25	25	25
M24	M16	-	-	28	28	28	28
M27	-	-	-	30	-	30	30
-	M20	φ25 / φ26	M24	32	32	32	32
M30	-	φ28	M27	35	35	35	35
-	-	φ30	-	37	-	37	37
-	-	φ32	-	40	-	40	40

Cleaning alternatives

Manual Cleaning (MC):

Hilti hand pump for blowing out drill holes with diameters d₀ ≤ 20 mm and drill hole depths h₀ ≤ 10·d



Compressed air cleaning (CAC):

Air nozzle with an orifice opening of minimum 3,5 mm in diameter.



Automatic Cleaning (AC):

Cleaning is performed during drilling with Hilti TE-CD and TE-YD drilling system including vacuum cleaner.



Injection System Hilti HIT-HY 200-A

Intended Use

Cleaning and setting tools

Annex B8

Installation instruction

Hole drilling

a) Hammer drilling

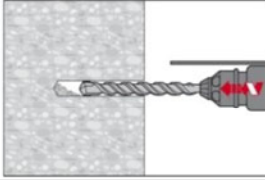

Drill hole to the required embedment depth with a hammer drill set in rotation-hammer mode using an appropriately sized carbide drill bit.

b) Hammer drilling with Hilti hollow drill bit

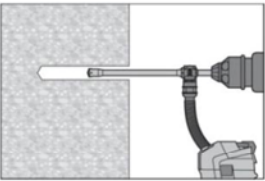

Drill hole to the required embedment depth with an appropriately sized Hilti TE-CD or TE-YD hollow drill bit with Hilti vacuum attachment. This drilling system removes the dust and cleans the bore hole during drilling when used in accordance with the user's manual. After drilling is completed, proceed to the "injection preparation" step in the installation instruction.

Drill hole cleaning

Just before setting an anchor, the drill hole must be free of dust and debris.
Inadequate hole cleaning = poor load values.

Manual Cleaning (MC)

non-cracked concrete only

for drill hole diameters $d_0 \leq 20$ mm and drill hole depths $h_0 \leq 10 \cdot d$

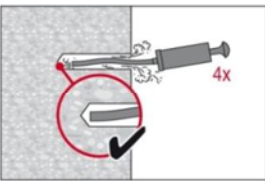

The Hilti hand pump may be used for blowing out drill holes up to diameters $d_0 \leq 20$ mm and embedment depths up to $h_{ef} \leq 10 \cdot d$.
Blow out at least 4 times from the back of the drill hole until return air stream is free of noticeable dust

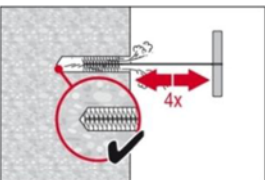

Brush 4 times with the specified brush (see Table B8) by inserting the steel brush Hilti HIT-RB to the back of the hole (if needed with extension) in a twisting motion and removing it.
The brush must produce natural resistance as it enters the drill hole (brush $\varnothing \geq$ drill hole \varnothing) - if not the brush is too small and must be replaced with the proper brush diameter.

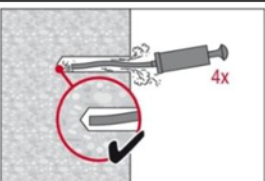

Blow out again with Hilti hand pump at least 4 times until return air stream is free of noticeable dust.

Injection System Hilti HIT-HY 200-A

Intended Use

Installation instructions

Annex B9

Compressed air cleaning (CAC) for all drill hole diameters d_0 and all drill hole depths h_0

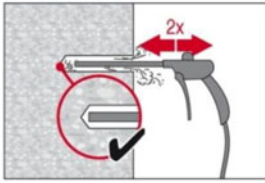

Blow 2 times from the back of the hole (if needed with nozzle extension) over the hole length with oil-free compressed air (min. 6 bar at 6 m³/h) until return air stream is free of noticeable dust.
For drill hole diameters ≥ 32 mm the compressor has to supply a minimum air flow of 140 m³/h.

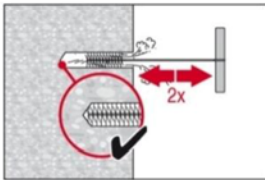

Brush 2 times with the specified brush (see Table B8) by inserting the steel brush Hilti HIT-RB to the back of the hole (if needed with extension) in a twisting motion and removing it.
The brush must produce natural resistance as it enters the drill hole (brush $\varnothing \geq$ drill hole \varnothing) - if not the brush is too small and must be replaced with the proper brush diameter.

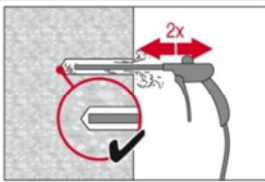

Blow again with compressed air 2 times until return air stream is free of noticeable dust.

Injection preparation

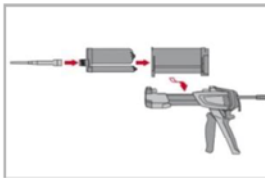

Tightly attach new Hilti mixing nozzle HIT-RE-M to foil pack manifold (snug fit). Do not modify the mixing nozzle.
Observe the instruction for use of the dispenser.
Check foil pack holder for proper function. Do not use damaged foil packs / holders.
Insert foil pack into foil pack holder and put holder into the dispenser.

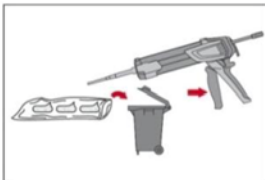

Discard initial adhesive. The foil pack opens automatically as dispensing is initiated. Depending on the size of the foil pack an initial amount of adhesive has to be discarded. Discarded quantities are

2 strokes	for 330 ml foil pack,
3 strokes	for 500 ml foil pack,
4 strokes	for 500 ml foil pack ≤ 5 °C.

Injection System Hilti HIT-HY 200-A

Intended Use
Installation instructions

Annex B10

Inject adhesive from the back of the drill hole without forming air voids.

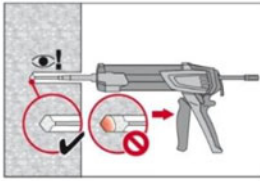

Inject the adhesive starting at the back of the hole, slowly withdrawing the mixer with each trigger pull.
Fill holes approximately 2/3 full, to ensure that the annular gap between the anchor and the concrete is completely filled with adhesive along the embedment length.

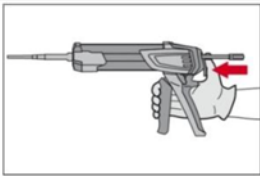

After injection is completed, depressurize the dispenser by pressing the release trigger. This will prevent further adhesive discharge from the mixer.

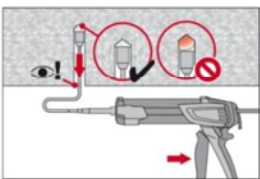

Overhead installation and/or installation with embedment depth $h_{ef} > 250\text{mm}$.
For overhead installation the injection is only possible with the aid of extensions and piston plugs. Assemble HIT-RE-M mixer, extension(s) and appropriately sized piston plug (see Table B8). Insert piston plug to back of the hole and inject adhesive. During injection the piston plug will be naturally extruded out of the drill hole by the adhesive pressure

Setting the element

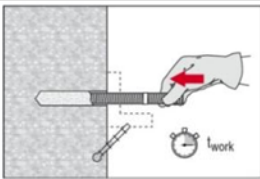

Before use, verify that the element is dry and free of oil and other contaminants. Mark and set element to the required embedment depth until working time t_{work} has elapsed. The working time t_{work} is given in Table B7.

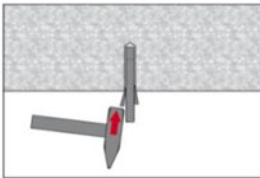

For overhead installation use piston plugs and fix embedded parts with e.g. wedges.

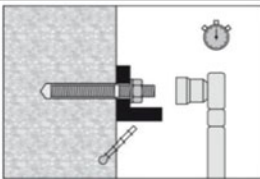

Loading the anchor: After required curing time t_{cure} (see Table B7) the anchor can be loaded.
The applied installation torque shall not exceed the values T_{max} given in Table B2 to Table B5.

Injection System Hilti HIT-HY 200-A

Intended Use
Installation instructions

Annex B11

**Table C1: Characteristic values of resistance for threaded rod, HIT-V-...
under tension loads in concrete**

HIT-HY 200-A with threaded rod, HIT-V-...				M8	M10	M12	M16	M20	M24	M27	M30
Installation safety factor	γ_2		[-]	1,0							
Steel failure											
Characteristic steel resistance	$N_{Rk,s}$		[kN]	$A_s \cdot f_{uk}$							
Combined pullout and concrete cone failure											
Characteristic bond resistance in non-cracked concrete C20/25											
Temperature range I: 40 °C/24 °C	$\tau_{Rk,ucr}$		[N/mm ²]	18							
Temperature range II: 80 °C/50 °C	$\tau_{Rk,ucr}$		[N/mm ²]	15							
Temperature range III: 120 °C/72 °C	$\tau_{Rk,ucr}$		[N/mm ²]	13							
Characteristic bond resistance in cracked concrete C20/25											
Temperature range I: 40 °C/24 °C	$\tau_{Rk,cr}$		[N/mm ²]	7,5	8,5			9,0			
Temperature range II: 80 °C/50 °C	$\tau_{Rk,cr}$		[N/mm ²]	6,0	7,0			7,5			
Temperature range III: 120 °C/72 °C	$\tau_{Rk,cr}$		[N/mm ²]	5,5	6,0			6,5			
Increasing factors for τ_{Rk} in concrete	ψ_c		C30/37	1,04							
			C40/45	1,07							
			C50/60	1,1							
Splitting failure											
Edge distance $c_{cr,sp}$ [mm] for		$h / h_{ef} \geq 2,0$		$1,0 \cdot h_{ef}$							
		$2,0 > h / h_{ef} > 1,3$		$4,6 h_{ef} - 1,8 h$							
		$h / h_{ef} \leq 1,3$		$2,26 h_{ef}$							
Spacing	$s_{cr,sp}$		[mm]	$2 \cdot c_{cr,sp}$							

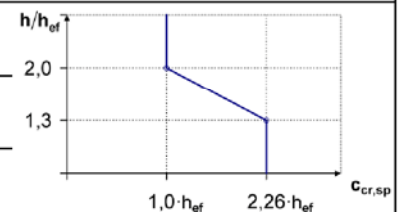

Injection System Hilti HIT-HY 200-A

Performances

Characteristic values of resistance under tension loads in concrete
Design according to „EOTA Technical Report TR 029, Edition September 2010“

Annex C1

**Table C2: Characteristic values of resistance for threaded rod, HIT-V-...
under shear loads**

HIT-HY 200-A with threaded rod, HIT-V-...		M8	M10	M12	M16	M20	M24	M27	M30	
Steel failure without lever arm										
Characteristic steel resistance	$V_{Rk,s}$	[kN]	$0,5 \cdot A_s \cdot f_{uk}$							
Steel failure with lever arm										
Characteristic bending moment	$M^0_{Rk,s}$	[Nm]	$1,2 \cdot W_{el} \cdot f_{uk}$							
Concrete pry-out failure										
Factor in equation (5.7) of Technical Report TR 029 for the design of bonded anchors	k	[-]	2,0							
Concrete edge failure										
The value of h_{ef} for calculation in equations (5.8a) and (5.8b) of Technical Report TR 029 is limited by:		$\min(h_{ef}; 12 \cdot d_{nom})$								
Outside diameter of anchor	d_{nom}	[mm]	8	10	12	16	20	24	27	30

Injection System Hilti HIT-HY 200-A

Performances

Characteristic values of resistance under shear loads in concrete
Design according to „EOTA Technical Report TR 029, Edition September 2010“

Annex C2

Table C3: Characteristic values of resistance for internally threaded sleeve HIS-(R)N under tension loads in concrete

Hilti HIT-HY 200-A with HIS-(R)N			M8	M10	M12	M16	M20
Installation safety factor	γ_2	[-]	1,0				
Steel failure threaded rods							
Characteristic resistance HIS-N with screw grade 8.8	$N_{Rk,s}$	[kN]	25	46	67	125	116
Partial safety factor	$\gamma_{Ms,N}^{1)}$	[-]	1,50				
Characteristic resistance HIS-RN with screw grade 70	$N_{Rk,s}$	[kN]	26	41	59	110	166
Partial safety factor	$\gamma_{Ms,N}^{1)}$	[-]	1,87				
Combined pull-out and Concrete cone failure							
Effective anchorage depth	h_{ef}	[mm]	90	110	125	170	205
Effective anchor diameter	d_1	[mm]	12,5	16,5	20,5	25,4	27,6
Characteristic bond resistance in non-cracked concrete C20/25							
Temperature range I: 40 °C/24 °C	$\tau_{Rk,ucr}$	[N/mm ²]	13				
Temperature range II: 80 °C/50 °C	$\tau_{Rk,ucr}$	[N/mm ²]	11				
Temperature range III: 120 °C/72 °C	$\tau_{Rk,ucr}$	[N/mm ²]	9,5				
Characteristic bond resistance in cracked concrete C20/25							
Temperature range I: 40 °C/24 °C	$\tau_{Rk,cr}$	[N/mm ²]	7				
Temperature range II: 80 °C/50 °C	$\tau_{Rk,cr}$	[N/mm ²]	5,5				
Temperature range III: 120 °C/72 °C	$\tau_{Rk,cr}$	[N/mm ²]	5				
Increasing factor for τ_{Rk} in concrete	ψ_c	C30/37	1,04				
		C40/45	1,07				
		C50/60	1,1				
Splitting failure relevant for non-cracked concrete							
Edge distance $c_{cr,sp}$ [mm] for	$h / h_{ef} \geq 2,0$		$1,0 \cdot h_{ef}$				
	$2,0 > h / h_{ef} > 1,3$		$4,6 \cdot h_{ef} - 1,8 \cdot h$				
	$h / h_{ef} \leq 1,3$		$2,26 \cdot h_{ef}$				
Spacing	$s_{cr,sp}$	[mm]	$2 \cdot c_{cr,sp}$				

¹⁾ In absence of national regulations.

Injection System Hilti HIT-HY 200-A

Performances

Characteristic values of resistance under tension loads in concrete
Design according to „EOTA Technical Report TR 029, Edition September 2010“

Annex C3

Table C4: Characteristic values of resistance for internally threaded sleeve HIS-(R)N under shear loads in concrete

Hilti HIT-HY 200-A with HIS-(R)N			M8	M10	M12	M16	M20
Steel failure without lever arm							
Characteristic resistance HIS-N with screw grade 8.8	$V_{Rk,s}$	[kN]	13	23	34	63	58
Partial safety factor	$\gamma_{Ms,V}^{1)}$	[-]	1,25				
Characteristic resistance HIS-RN with screw grade 70	$V_{Rk,s}$	[kN]	13	20	30	55	83
Partial safety factor	$\gamma_{Ms,V}^{1)}$	[-]	1,56				2,0
Steel failure with lever arm							
Characteristic resistance HIS-N with screw grade 8.8	$M_{Rk,s}^o$	[Nm]	30	60	105	266	519
Partial safety factor	$\gamma_{Ms,V}^{1)}$	[-]	1,25				
Characteristic resistance HIS-RN with screw grade 70	$M_{Rk,s}^o$	[Nm]	26	52	92	233	454
Partial safety factor	$\gamma_{Ms,V}^{1)}$	[-]	1,56				
Concrete pry-out failure							
Factor in equation (5.7) of Technical Report TR 029 for the design of bonded anchors	k	[-]	2,0				
Concrete edge failure							
Outside diameter of anchor	d_{nom}	[mm]	12,5	16,5	20,5	25,4	27,6

¹⁾ In absence of national regulations.

Injection System Hilti HIT-HY 200-A

Performances

Characteristic values of resistance under shear loads in concrete
Design according to „EOTA Technical Report TR 029, Edition September 2010“

Annex C4

Table C5: Characteristic values of resistance for Hilti tension anchor HZA / HZA-R under tension loads in concrete

Hilti HIT-HY 200-A with HZA, HZA-R			M12	M16	M20	M24	M27
Installation safety factor	γ_2	[-]	1,0				
Steel failure							
Characteristic resistance HZA	$N_{Rk,s}$	[kN]	46	86	135	194	253
Characteristic resistance HZA-R	$N_{Rk,s}$	[kN]	62	111	173	248	-
Partial safety factor	$\gamma_{Ms}^{1)}$	[-]	1,4				
Combined pull-out and concrete cone failure							
Diameter of rebar	d	[mm]	12	16	20	25	28
Characteristic bond resistance in non-cracked concrete C20/25							
Temperature range I: 40 °C/24 °C	$\tau_{Rk,ucr}$	[N/mm ²]	12				
Temperature range II: 80 °C/50 °C	$\tau_{Rk,ucr}$	[N/mm ²]	10				
Temperature range III: 120 °C/72 °C	$\tau_{Rk,ucr}$	[N/mm ²]	8,5				
Characteristic bond resistance in cracked concrete C20/25							
Temperature range I: 40 °C/24 °C	$\tau_{Rk,cr}$	[N/mm ²]	7				
Temperature range II: 80 °C/50 °C	$\tau_{Rk,cr}$	[N/mm ²]	5,5				
Temperature range III: 120 °C/72 °C	$\tau_{Rk,cr}$	[N/mm ²]	5				
Increasing factor for τ_{Rk} in concrete	ψ_c	C30/37	1,04				
		C40/45	1,07				
		C50/60	1,1				
Effective anchorage depth for calculation of $N_{Rk,p}^0$ acc. Eq. 5.2a (TR 029, 5.2.2.3 Combined pull-out and concrete cone failure)	HZA	h_{ef} [mm]	$h_{nom} - 20$				
	HZA-R	h_{ef} [mm]	$h_{nom} - 100$				
Concrete cone failure							
Effective anchorage depth for calculation of $N_{Rk,c}^0$ acc. Eq. 5.3a (TR 029, 5.2.2.4 Concrete cone failure)	HZA HZA-R	h_{ef} [mm]	h_{nom}				
Splitting failure relevant for non-cracked concrete							
Edge distance $c_{Cr,sp}$ [mm] for	$h / h_{ef} \geq 2,0$		$1,0 \cdot h_{ef}$				
	$2,0 > h / h_{ef} > 1,3$		$4,6 \cdot h_{ef} - 1,8 \cdot h$				
	$h / h_{ef} \leq 1,3$		$2,26 \cdot h_{ef}$				
Spacing	$s_{cr,sp}$	[mm]	$2 \cdot c_{cr,sp}$				

¹⁾ In absence of national regulations.

Injection System Hilti HIT-HY 200-A

Performances

Characteristic values of resistance under tension loads in concrete
Design according to „EOTA Technical Report TR 029, Edition September 2010“

Annex C5

Table C6: Characteristic values of resistance for Hilti tension anchor HZA, HZA-R under shear loads in concrete

Hilti HIT-HY 200-A with HZA, HZA-R				M12	M16	M20	M24	M27
Steel failure without lever arm								
Characteristic resistance	HZA	$V_{Rk,s}$	[kN]	23	43	67	97	126
Characteristic resistance	HZA-R	$V_{Rk,s}$	[kN]	31	55	86	124	-
Partial safety factor		γ_{Ms} ¹⁾	[-]	1,5				
Steel failure with lever arm								
Characteristic resistance	HZA	$M_{Rk,s}^0$	[Nm]	72	183	357	617	915
Characteristic resistance	HZA-R	$M_{Rk,s}^0$	[Nm]	97	234	457	790	-
Partial safety factor		γ_{Ms} ¹⁾	[-]	1,5				
Concrete pry-out failure								
Factor in equation (5.7) of Technical Report TR 029 for the design of bonded anchors		k	[-]	2,0				
Concrete edge failure								
The value of h_{ef} for calculation in equations (5.8a) and (5.8b) of Technical Report TR 029 is limited by:				min (h_{nom} ; $12 \cdot d_{nom}$)				
Outside diameter of anchor		d_{nom}	[mm]	12	16	20	24	27

¹⁾ In absence of national regulations.

Injection System Hilti HIT-HY 200-A

Performances

Characteristic values of resistance under shear loads in concrete
Design according to „EOTA Technical Report TR 029, Edition September 2010“

Annex C6

Table C7: Characteristic values of resistance for rebar under tension loads in concrete

HIT-HY 200-A with rebar		φ 8	φ 10	φ 12	φ 14	φ 16	φ 20	φ 25	φ 26	φ 28	φ 30	φ 32
Installation safety factor	γ_2 [-]	1,0										
Steel failure												
Characteristic resistance for rebar B500B acc. to DIN 488:2009-08 ¹⁾	$N_{Rk,s}$ [kN]	28	43	62	85	111	173	270	292	339	388	442
Combined pull-out and Concrete cone failure												
Diameter of rebar	d [mm]	8	10	12	14	16	20	25	26	28	30	32
Characteristic bond resistance in non-cracked concrete C20/25												
Temperature range I: 40°C/24°C	$\tau_{Rk,ucr}$ [N/mm ²]	12										
Temperature range II: 80°C/50°C	$\tau_{Rk,ucr}$ [N/mm ²]	10										
Temperature range III: 120°C/72°C	$\tau_{Rk,ucr}$ [N/mm ²]	8,5										
Characteristic bond resistance in cracked concrete C20/25												
Temperature range I: 40°C/24°C	$\tau_{Rk,cr}$ [N/mm ²]	-	5	7								
Temperature range II: 80°C/50°C	$\tau_{Rk,cr}$ [N/mm ²]	-	4	5,5								
Temperature range III: 120°C/72°C	$\tau_{Rk,cr}$ [N/mm ²]	-	3,5	5								
Increasing factor for τ_{Rk} in concrete	ψ_c	C30/37										
		C40/45										
		C50/60										
Splitting failure relevant for non-cracked concrete												
Edge distance $c_{cr,sp}$ [mm] for	$h / h_{ef} \geq 2,0$	$1,0 \cdot h_{ef}$										
	$2,0 > h / h_{ef} > 1,3$	$4,6 \cdot h_{ef} - 1,8 \cdot h$										
	$h / h_{ef} \leq 1,3$	$2,26 \cdot h_{ef}$										
Spacing	$s_{cr,sp}$ [mm]	$2 c_{cr,sp}$										

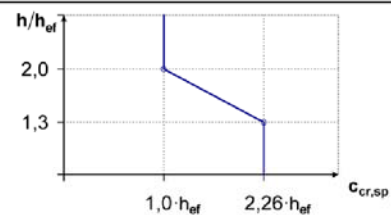

¹⁾ The characteristic tension resistance $N_{Rk,s}$ for rebars that do not fulfil the requirements acc. DIN 488 shall be calculated acc. Technical Report TR 029, Equation (5.1).

Injection System Hilti HIT-HY 200-A

Performances

Characteristic values of resistance under tension loads in concrete
Design according to „EOTA Technical Report TR 029, Edition September 2010“

Annex C7

Table C8: Characteristic values of resistance for rebar under shear loads in concrete

HIT-HY 200-A with rebar	$\phi 8$	$\phi 10$	$\phi 12$	$\phi 14$	$\phi 16$	$\phi 20$	$\phi 25$	$\phi 26$	$\phi 28$	$\phi 30$	$\phi 32$
Steel failure without lever arm											
Characteristic resistance for rebar B500B acc. to DIN 488:2009-08 ¹⁾ $V_{Rk,s}$ [kN]	14	22	31	42	55	86	135	146	169	194	221
Steel failure with lever arm											
Characteristic resistance for rebar B500B acc. to DIN 488:2009-08 ²⁾ $M^o_{Rk,s}$ [Nm]	33	65	112	178	265	518	1012	1139	1422	1749	2123
Concrete pry-out failure											
Factor in equation (5.7) of Technical Report TR 029 for the design of bonded anchors k [-]	2,0										
Concrete edge failure											
The value of h_{ef} for calculation in equations (5.8a) and (5.8b) of Technical Report TR 029 is limited by:	$\min(h_{ef}; 12 \cdot d_{nom})$										
Outside diameter of anchor d_{nom} [mm]	8	10	12	14	16	20	25	26	28	30	32

¹⁾ The characteristic shear resistance $V_{Rk,s}$ for rebars that do not fulfil the requirements acc. DIN 488 shall be calculated acc. Technical Report TR 029, Equation (5.5).

²⁾ The characteristic bending resistance $M^o_{Rk,s}$ for rebars that do not fulfil the requirements acc. DIN 488 shall be calculated acc. Technical Report TR 029, Equation (5.6b).

Injection System Hilti HIT-HY 200-A

Performances

Characteristic values of resistance under shear loads in concrete
Design according to „EOTA Technical Report TR 029, Edition September 2010“

Annex C8

Table C9: Displacements under tension load

Hilti HIT-HY 200-A with threaded rod, HIT-V-...		M8	M10	M12	M16	M20	M24	M27	M30	
Non-cracked concrete temperature range I : 40°C / 24°C										
Displacement	δ_{N0}	[mm/(N/mm ²)]	0,02	0,03	0,03	0,04	0,06	0,07	0,07	0,08
	$\delta_{N\infty}$	[mm/(N/mm ²)]	0,04	0,05	0,06	0,08	0,10	0,13	0,14	0,16
Non-cracked concrete temperature range II : 80°C / 50°C										
Displacement	δ_{N0}	[mm/(N/mm ²)]	0,03	0,04	0,05	0,06	0,08	0,09	0,10	0,12
	$\delta_{N\infty}$	[mm/(N/mm ²)]	0,04	0,05	0,06	0,09	0,11	0,13	0,15	0,16
Non-cracked concrete temperature range III : 120°C / 72°C										
Displacement	δ_{N0}	[mm/(N/mm ²)]	0,04	0,05	0,06	0,08	0,10	0,12	0,13	0,16
	$\delta_{N\infty}$	[mm/(N/mm ²)]	0,04	0,05	0,07	0,09	0,11	0,13	0,15	0,17
Cracked concrete temperature range I : 40°C / 24°C										
Displacement	δ_{N0}	[mm/(N/mm ²)]	0,07							
	$\delta_{N\infty}$	[mm/(N/mm ²)]	0,16							
Cracked concrete temperature range II : 80°C / 50°C										
Displacement	δ_{N0}	[mm/(N/mm ²)]	0,10							
	$\delta_{N\infty}$	[mm/(N/mm ²)]	0,22							
Cracked concrete temperature range III : 120°C / 72°C										
Displacement	δ_{N0}	[mm/(N/mm ²)]	0,13							
	$\delta_{N\infty}$	[mm/(N/mm ²)]	0,29							

Table C10: Displacements under shear load

Hilti HIT-HY 200-A with threaded rod, HIT-V-...		M8	M10	M12	M16	M20	M24	M27	M30	
Displacement	δ_{V0}	[mm/kN]	0,06	0,06	0,05	0,04	0,04	0,03	0,03	0,03
	$\delta_{V\infty}$	[mm/kN]	0,09	0,08	0,08	0,06	0,06	0,05	0,05	0,05

Injection System Hilti HIT-HY 200-A

Performances
Displacements with HIT-V-...

Annex C9

Table C11: Displacements under tension load

Hilti HIT-HY 200-A with HIS-(R)N		M8	M10	M12	M16	M20
Non-cracked concrete temperature range I : 40°C / 24°C						
Displacement	δ_{N0} [mm/(N/mm ²)]	0,03	0,05	0,06	0,07	0,08
	$\delta_{N\infty}$ [mm/(N/mm ²)]	0,06	0,09	0,11	0,13	0,14
Non-cracked concrete temperature range II : 80°C / 50°C						
Displacement	δ_{N0} [mm/(N/mm ²)]	0,05	0,06	0,08	0,10	0,11
	$\delta_{N\infty}$ [mm/(N/mm ²)]	0,07	0,09	0,11	0,13	0,15
Non-cracked concrete temperature range III : 120°C / 72°C						
Displacement	δ_{N0} [mm/(N/mm ²)]	0,06	0,08	0,10	0,13	0,14
	$\delta_{N\infty}$ [mm/(N/mm ²)]	0,07	0,09	0,11	0,14	0,15
Cracked concrete temperature range I : 40°C / 24°C						
Displacement	δ_{N0} [mm/(N/mm ²)]					0,11
	$\delta_{N\infty}$ [mm/(N/mm ²)]					0,16
Cracked concrete temperature range II : 80°C / 50°C						
Displacement	δ_{N0} [mm/(N/mm ²)]					0,15
	$\delta_{N\infty}$ [mm/(N/mm ²)]					0,22
Cracked concrete temperature range III : 120°C / 72°C						
Displacement	δ_{N0} [mm/(N/mm ²)]					0,20
	$\delta_{N\infty}$ [mm/(N/mm ²)]					0,29

Table C12: Displacements under shear load

Hilti HIT-HY 200-A with HIS-(R)N		M8	M10	M12	M16	M20
Displacement	δ_{V0} [mm/kN]	0,06	0,06	0,05	0,04	0,04
	$\delta_{V\infty}$ [mm/kN]	0,09	0,08	0,08	0,06	0,06

Injection System Hilti HIT-HY 200-A

Performances
Displacements with HIS-(R)N

Annex C10

Table C13: Displacements under tension load

Hilti HIT-HY 200-A with HZA, HZA-R			M12	M16	M20	M24	M27
Non-cracked concrete temperature range I : 40°C / 24°C							
Displacement	δ_{N0}	[mm/(N/mm ²)]	0,03	0,04	0,06	0,07	0,08
	$\delta_{N\infty}$	[mm/(N/mm ²)]	0,06	0,08	0,13	0,13	0,15
Non-cracked concrete temperature range II : 80°C / 50°C							
Displacement	δ_{N0}	[mm/(N/mm ²)]	0,05	0,06	0,08	0,10	0,11
	$\delta_{N\infty}$	[mm/(N/mm ²)]	0,06	0,09	0,14	0,14	0,15
Non-cracked concrete temperature range III : 120°C / 72°C							
Displacement	δ_{N0}	[mm/(N/mm ²)]	0,06	0,08	0,10	0,12	0,14
	$\delta_{N\infty}$	[mm/(N/mm ²)]	0,07	0,09	0,14	0,14	0,16
Cracked concrete temperature range I : 40°C / 24°C							
Displacement	δ_{N0}	[mm/(N/mm ²)]	0,11				
	$\delta_{N\infty}$	[mm/(N/mm ²)]	0,16				
Cracked concrete temperature range II : 80°C / 50°C							
Displacement	δ_{N0}	[mm/(N/mm ²)]	0,15				
	$\delta_{N\infty}$	[mm/(N/mm ²)]	0,22				
Cracked concrete temperature range III : 120°C / 72°C							
Displacement	δ_{N0}	[mm/(N/mm ²)]	0,20				
	$\delta_{N\infty}$	[mm/(N/mm ²)]	0,29				

Table C14: Displacements under shear load

Hilti HIT-HY 200-A with HZA, HZA-R			M12	M16	M20	M24	M27
Displacement	δ_{V0}	[mm/kN]	0,05	0,04	0,04	0,03	0,03
	$\delta_{V\infty}$	[mm/kN]	0,08	0,06	0,06	0,05	0,05

Injection System Hilti HIT-HY 200-A

Performances
Displacements with HZA, HZA-R

Annex C11

Table C15: Displacements under tension load

Hilti HIT-HY 200-A with rebar	φ 8	φ 10	φ 12	φ 14	φ 16	φ 20	φ 25	φ 26	φ 28	φ 30	φ 32		
Non-cracked concrete temperature range I : 40°C / 24°C													
Displacement	δ_{N0} [mm/(N/mm ²)]	0,02	0,03	0,03	0,04	0,04	0,06	0,07	0,08	0,08	0,09	0,09	
	$\delta_{N\infty}$ [mm/(N/mm ²)]	0,04	0,05	0,06	0,07	0,08	0,10	0,13	0,14	0,15	0,16	0,17	
Non-cracked concrete temperature range II : 80°C / 50°C													
Displacement	δ_{N0} [mm/(N/mm ²)]	0,03	0,04	0,05	0,05	0,06	0,08	0,10	0,11	0,11	0,12	0,12	
	$\delta_{N\infty}$ [mm/(N/mm ²)]	0,04	0,05	0,06	0,07	0,09	0,11	0,14	0,15	0,15	0,16	0,17	
Non-cracked concrete temperature range III : 120°C / 72°C													
Displacement	δ_{N0} [mm/(N/mm ²)]	0,04	0,05	0,06	0,07	0,08	0,10	0,12	0,13	0,14	0,15	0,16	
	$\delta_{N\infty}$ [mm/(N/mm ²)]	0,04	0,05	0,07	0,08	0,09	0,11	0,14	0,15	0,16	0,17	0,18	
Cracked concrete temperature range I : 40°C / 24°C													
Displacement	δ_{N0} [mm/(N/mm ²)]						0,11						
	$\delta_{N\infty}$ [mm/(N/mm ²)]						0,16						
Cracked concrete temperature range II : 80°C / 50°C													
Displacement	δ_{N0} [mm/(N/mm ²)]						0,15						
	$\delta_{N\infty}$ [mm/(N/mm ²)]						0,22						
Cracked concrete temperature range III : 120°C / 72°C													
Displacement	δ_{N0} [mm/(N/mm ²)]						0,20						
	$\delta_{N\infty}$ [mm/(N/mm ²)]						0,29						

Table C16: Displacements under shear load

Hilti HIT-HY 200-A with rebar	φ 8	φ 10	φ 12	φ 14	φ 16	φ 20	φ 25	φ 26	φ 28	φ 30	φ 32
Displacement	δ_{V0} [mm/kN]	0,06	0,05	0,05	0,04	0,04	0,04	0,03	0,03	0,03	0,03
	$\delta_{V\infty}$ [mm/kN]	0,09	0,08	0,07	0,06	0,06	0,05	0,05	0,05	0,04	0,04

Injection System Hilti HIT-HY 200-A

Performances
Displacements with rebar

Annex C12

Seismic design shall be carried out according to the TR 045 „Design of Metal Anchors Under Seismic Action“

Table C17: Characteristic values of resistance for threaded rod, HIT-V-... under tension loads for seismic performance category C1

HIT-HY 200-A with threaded rod, HIT-V-...		M8	M10	M12	M16	M20	M24	M27	M30
Steel failure									
HIT-V-5.8(F), threaded rod 5.8	$N_{Rk,s,seis}$ [kN]	-	29	42	79	123	177	230	281
HIT-V-8.8(F), threaded rod 8.8	$N_{Rk,s,seis}$ [kN]	-	46	67	126	196	282	367	449
HIT-V-R, threaded rod A4-70	$N_{Rk,s,seis}$ [kN]	-	41	59	110	172	247	230	281
HIT-V-HCR, threaded rod HCR-80	$N_{Rk,s,seis}$ [kN]	-	46	67	126	196	247	321	393
Combined pullout and concrete cone failure									
Characteristic bond resistance in cracked concrete C20/25									
Temperature range I: 40 °C/24 °C	$\tau_{Rk,seis}$ [N/mm ²]	-	5,2	7,0					
Temperature range II: 80 °C/50 °C	$\tau_{Rk,seis}$ [N/mm ²]	-	3,9	5,7					
Temperature range III: 120 °C/72 °C	$\tau_{Rk,seis}$ [N/mm ²]	-	3,5	4,8					

Table C18: Characteristic values of resistance for threaded rod, HIT-V-... under shear loads for seismic performance category C1

HIT-HY 200-A with threaded rod, HIT-V-...		M8	M10	M12	M16	M20	M24	M27	M30
Steel failure without lever arm									
HIT-V 5.8(F), threaded rod 5.8	$V_{Rk,s,seis}$ [kN]	-	11	15	27	43	62	81	98
HIT-V 8.8(F), threaded rod 8.8	$V_{Rk,s,seis}$ [kN]	-	16	24	44	69	99	129	157
HIT-V R, threaded rod A4-70	$V_{Rk,s,seis}$ [kN]	-	14	21	39	60	87	81	98
HIT-V HCR, threaded rod HCR-80	$V_{Rk,s,seis}$ [kN]	-	16	24	44	69	87	113	137

Table C19: Displacements under tension load for seismic performance category C1

HIT-HY 200-A with threaded rod, HIT-V-...		M8	M10	M12	M16	M20	M24	M27	M30
Displacement ¹⁾	$\delta_{N,seis}$ [mm]	-	0,8	0,8	0,8	0,8	0,8	0,8	0,8

¹⁾ Maximum displacement during cycling (seismic event).

Table C20: Displacements under shear load for seismic performance category C1

HIT-HY 200-A with threaded rod, HIT-V-...		M8	M10	M12	M16	M20	M24	M27	M30
Displacement ¹⁾	$\delta_{V,seis}$ [mm]	-	3,5	3,8	4,4	5,0	5,6	6,1	6,5

¹⁾ Maximum displacement during cycling (seismic event).

Injection System Hilti HIT-HY 200-A

Performances

Characteristic values for seismic performance category C1 and displacements
Design according to „EOTA Technical Report TR045, Edition February 2013 “

Annex C13

Table C21: Characteristic values of resistance for Hilti tension anchor HZA, HZA-R under tension loads for seismic performance category C1

HIT-HY 200-A with Hilti tension anchor HZA, HZA-R			M12	M16	M20	M24	M27
Steel failure							
Characteristic resistance HZA	$N_{Rk,s,seis}$	[kN]	46	86	135	194	253
Characteristic resistance HZA-R	$N_{Rk,s,seis}$	[kN]	62	111	173	248	-
Partial safety factor	$\gamma_{Ms,N,seis}$ ¹⁾	[-]	1,4				
Combined pull-out and concrete cone failure¹⁾							
Diameter of rebar	d	[mm]	12	16	20	25	28
Characteristic bond resistance in cracked concrete C20/25							
Temperature range I:	40°C/24°C	$\tau_{Rk,cr}$	[N/mm ²]		6,1		
Temperature range II:	80°C/50°C	$\tau_{Rk,cr}$	[N/mm ²]		4,8		
Temperature range III:	120°C/72°C	$\tau_{Rk,cr}$	[N/mm ²]		4,4		

¹⁾ In absence of national regulations.

Table C22: Characteristic values of resistance for Hilti tension anchor HZA, HZA-R under shear loads for seismic performance category C1

HIT-HY 200-A with Hilti tension anchor HZA, HZA-R			M12	M16	M20	M24	M27
Steel failure without lever arm							
Characteristic resistance HZA	$V_{Rk,s,seis}$	[kN]	16	30	47	68	88
Characteristic resistance HZA-R	$V_{Rk,s,seis}$	[kN]	22	39	60	124	-
Partial safety factor	$\gamma_{Ms,V,seis}$ ¹⁾	[-]	1,5				

¹⁾ In absence of national regulations.

Table C23: Displacements under tension load for seismic performance category C1

HIT-HY 200-A with Hilti tension anchor HZA, HZA-R			M12	M16	M20	M24	M27
Displacement ¹⁾	$\delta_{N,seis}$	[mm]	1,3	1,3	1,3	1,3	1,3

¹⁾ Maximum displacement during cycling (seismic event).

Table C24: Displacements under shear load for seismic performance category C1

HIT-HY 200-A with Hilti tension anchor HZA, HZA-R			M12	M16	M20	M24	M27
Displacement ¹⁾	$\delta_{V,seis}$	[mm]	3,8	4,4	5,0	5,6	6,1

¹⁾ Maximum displacement during cycling (seismic event).

Injection System Hilti HIT-HY 200-A

Performances

Characteristic values for seismic performance category C1 and displacements
Design according to „EOTA Technical Report TR 045, Edition February 2013“

Annex C14

Table C25: Characteristic values of resistance for rebar under tension loads for seismic performance category C1

HIT-HY 200-A with rebar	φ 8	φ 10	φ 12	φ 14	φ 16	φ 20	φ 25	φ 26	φ 28	φ 30	φ 32
Steel failure											
Characteristic resistance for rebar B500B acc. to DIN 488:2009-08 ¹⁾ $N_{Rk,seis}$ [kN]	-	43	62	85	111	173	270	292	339	388	442
Combined pull-out and Concrete cone failure											
Diameter of rebar d [mm]	-	10	12	14	16	20	25	26	28	30	32
Characteristic bond resistance in cracked concrete C20/25											
Temperature range I: 40°C/24°C $\tau_{Rk,cr}$ [N/mm ²]	-	4,4					6,1				
Temperature range II: 80°C/50°C $\tau_{Rk,cr}$ [N/mm ²]	-	3,5					4,8				
Temperature range III: 120°C/72°C $\tau_{Rk,cr}$ [N/mm ²]	-	3					4,4				

¹⁾ The characteristic tension resistance $N_{Rk,s,seis}$ for rebars that do not fulfil the requirements acc. DIN 488 shall be calculated acc. Technical Report TR 029, Equation (5.1), $N_{Rk,s,seis} = N_{Rk,s}$.

Table C26: Characteristic values of resistance for rebar under shear loads for seismic performance category C1

HIT-HY 200-A with rebar	φ 8	φ 10	φ 12	φ 14	φ 16	φ 20	φ 25	φ 26	φ 28	φ 30	φ 32
Steel failure without lever arm											
Characteristic resistance for rebar B500B acc. to DIN 488:2009-08 $V_{Rk,s,seis}$ [kN]	-	15	22	29	39	60	95	102	118	135	165

¹⁾ The characteristic shear resistance $V_{Rk,s,seis}$ for rebars that do not fulfil the requirements acc. DIN 488 shall be calculated acc. Technical Report TR 029, Equation (5.5), $V_{Rk,s,seis} = 0,7 \times V_{Rk,s}$.

Table C27: Displacements under tension load for seismic performance category C1

Hilti HIT-HY 200-A with rebar	φ 8	φ 10	φ 12	φ 14	φ 16	φ 20	φ 25	φ 26	φ 28	φ 30	φ 32
Displacement ¹⁾ $\delta_{N,seis}$ [mm]	-	1,3	1,3	1,3	1,3	1,3	1,3	1,3	1,3	1,3	1,3

¹⁾ Maximum displacement during cycling (seismic event).

Table C28: Displacements under shear load for seismic performance category C1

Hilti HIT-HY 200-A with rebar	φ 8	φ 10	φ 12	φ 14	φ 16	φ 20	φ 25	φ 26	φ 28	φ 30	φ 32
Displacement ¹⁾ $\delta_{V,seis}$ [mm]	-	3,5	3,8	4,1	4,4	5,0	5,8	6,2	6,2	6,8	6,8

¹⁾ Maximum displacement during cycling (seismic event).

Injection System Hilti HIT-HY 200-A

Performances

Characteristic values for seismic performance category C1 and displacements
Design according to „EOTA Technical Report TR 045, Edition February 2013“

Annex C15