

Approval body for construction products
and types of construction

Bautechnisches Prüfamt

An institution established by the Federal and
Laender Governments



European Technical Assessment

ETA-13/0258
of 11 May 2015

English translation prepared by DIBt - Original version in German language

General Part

Technical Assessment Body issuing the
European Technical Assessment:

Deutsches Institut für Bautechnik

Trade name of the construction product

DEWALT AC100-PRO injection resin with anchor rod

Product family
to which the construction product belongs

Bonded anchor for use in concrete under static,
quasi-static or seismic action (performance category C1)

Manufacturer

DeWalt
Black & Decker Straße 40
65510 Idstein
DEUTSCHLAND

Manufacturing plant

Herstellwerk 1
Herstellwerk 2

This European Technical Assessment
contains

38 pages including 3 annexes which form an integral part
of this assessment

This European Technical Assessment is
issued in accordance with Regulation (EU)
No 305/2011, on the basis of

Guideline for European technical approval of "Metal
anchors for use in concrete", ETAG 001 Part 5: "Bonded
anchors", April 2013,
used as European Assessment Document (EAD)
according to Article 66 Paragraph 3 of Regulation (EU)
No 305/2011.

The European Technical Assessment is issued by the Technical Assessment Body in its official language. Translations of this European Technical Assessment in other languages shall fully correspond to the original issued document and shall be identified as such.

Communication of this European Technical Assessment, including transmission by electronic means, shall be in full. However, partial reproduction may only be made with the written consent of the issuing Technical Assessment Body. Any partial reproduction has to be identified as such.

This European Technical Assessment may be withdrawn by the issuing Technical Assessment Body, in particular pursuant to information by the Commission according to Article 25 Paragraph 3 of Regulation (EU) No 305/2011.

Specific Part

1 Technical description of the product

The "DEWALT AC1000-PRO Injection resin with anchor rod for concrete" is a bonded anchor consisting of a cartridge with injection mortar DEWALT AC100-PRO and a steel element. The steel element consist of a commercial threaded rod with washer and hexagon nut in the range of M8 to M30 or a reinforcing bar in the range of diameter 8 to 32 mm or threaded sleeves with internal thread of sizes M8 to M16.

The steel element is placed into a drilled hole filled with injection mortar and is anchored via the bond between metal part, injection mortar and concrete.

The product description is given in Annex A.

2 Specification of the intended use in accordance with the applicable European Assessment Document

The performances given in Section 3 are only valid if the anchor is used in compliance with the specifications and conditions given in Annex B.

The verifications and assessment methods on which this European Technical Assessment is based lead to the assumption of a working life of the anchor of at least 50 years. The indications given on the working life cannot be interpreted as a guarantee given by the producer, but are to be regarded only as a means for choosing the right products in relation to the expected economically reasonable working life of the works.

3 Performance of the product and references to the methods used for its assessment

3.1 Mechanical resistance and stability (BWR 1)

Essential characteristic	Performance
Characteristic resistance for design according to TR 029	See Annex C 1 to C9
Characteristic resistance for design according to CEN/TS 1992-4:2009	See Annex C 10 to C 18
Characteristic resistance for design according to TR 045	See Annex C 22 to C 25
Displacements under tension and shear loads	See Annex C 19 to C 25

3.2 Safety in case of fire (BWR 2)

Essential characteristic	Performance
Reaction to fire	Anchorage satisfy requirements for Class A1
Resistance to fire	No performance determined (NPD)

3.3 Hygiene, health and the environment (BWR 3)

Not applicable.

3.4 Safety in use (BWR 4)

The essential characteristics regarding Safety in use are included under the Basic Works Requirement Mechanical resistance and stability.

3.5 Protection against noise (BWR 5)

Not applicable.

English translation prepared by DIBt

3.6 Energy economy and heat retention (BWR 6)

Not applicable.

3.7 Sustainable use of natural resources (BWR 7)

The sustainable use of natural resources was not investigated.

3.8 General aspects

The verification of durability is part of testing the essential characteristics. Durability is only ensured if the specifications of intended use according to Annex B are taken into account.

4 Assessment and verification of constancy of performance (AVCP) system applied, with reference to its legal base

According to Decision of the Commission of 24 June 1996 (96/582/EC) (OJ L 254 of 08.10.96 p. 62-65), the system of assessment and verification of constancy of performance (see Annex V and Article 65 Paragraph 2 to Regulation (EU) No 305/2011) given in the following table applies.

Product	Intended use	Level or class	System
Metal anchors for use in concrete (heavy-duty type)	For fixing and/or supporting concrete structural elements or heavy units such as cladding and suspended ceilings	—	1

5 Technical details necessary for the implementation of the AVCP system, as provided for in the applicable European Assessment Document

Technical details necessary for the implementation of the AVCP system are laid down in the control plan deposited at Deutsches Institut für Bautechnik.

Issued in Berlin on 11 May 2015 by Deutsches Institut für Bautechnik

Uwe Bender
Head of Department

beglaubigt:
Baderschneider

Threaded rod M8, M10, M12, M16, M20, M24, M27 and M30 with washer and nut



Reinforcing bar $\varnothing 8$, $\varnothing 10$, $\varnothing 12$, $\varnothing 14$, $\varnothing 16$, $\varnothing 20$, $\varnothing 24$, $\varnothing 25$, $\varnothing 28$ and $\varnothing 32$



Internal threaded sleeve M8, M10, M12, M16 and M20

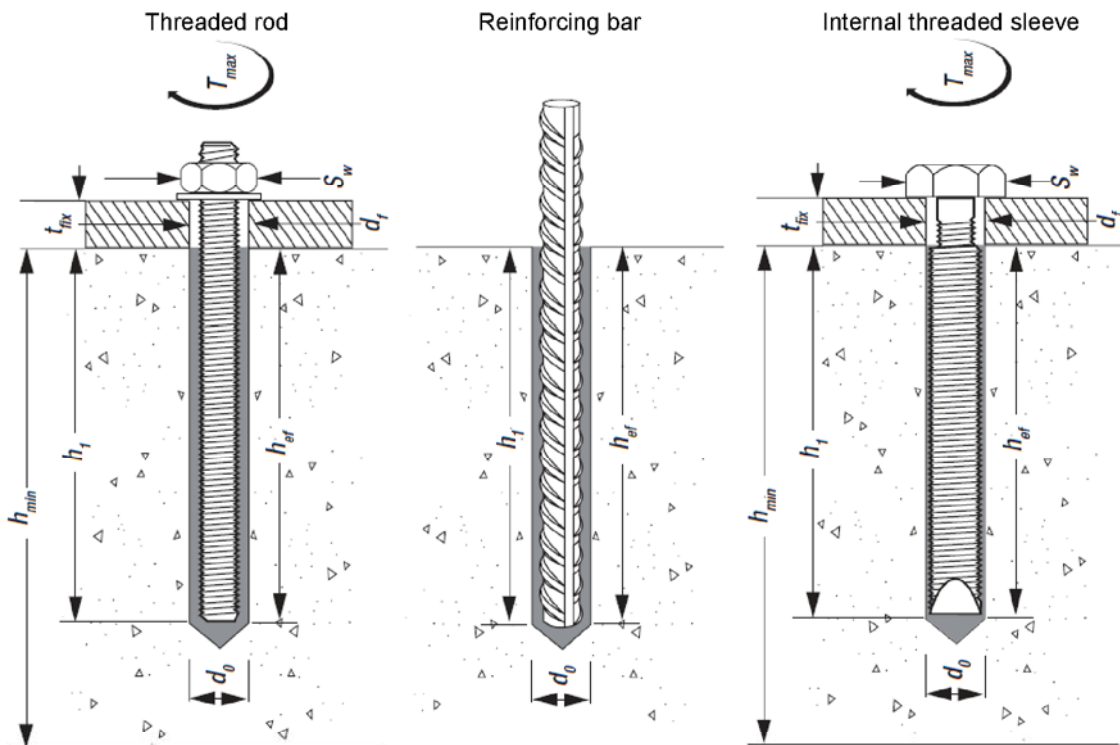

DEWALT AC100-PRO Injection resin with anchor rod for concrete

Annex A1

Product description
Product and Installation



<p>Sealing/Screw cap 160 ml, 300 ml, 360 ml and 420 ml cartridge</p>  <p>Imprint: DEWALT AC100-PRO, processing notes, charge-code, shelf life, hazard-code, curing- and processing time (depending on the temperature)</p>  <p>Component B: Hardener (inner tube)</p> <p>Component A: Injection mortar (outer tube)</p>	
<p>235 ml, 360 ml and 825 ml cartridge (Type: "side-by-side")</p>  <p>Imprint: DEWALT AC100-PRO, processing notes, charge-code, shelf life, hazard-code, curing- and processing time (depending on the temperature)</p>  <p>Component B: Hardener</p> <p>Component A: Injection mortar</p> <p>Sealing / Screw cap</p>	
<p>165 ml and 300 ml cartridge (Type: "foil tube")</p>  <p>Imprint: DEWALT AC100-PRO, processing notes, charge-code, shelf life, hazard-code, curing- and processing time (depending on the temperature), with as well as without travel scale</p>  <p>Component B: Hardener and component A mortar in foil package</p> <p>Sealing / Screw cap</p>	
<p>Static Mixer</p> 	
<p>DEWALT AC100-PRO Injection resin with anchor rod for concrete</p>	<p>Annex A2</p>
<p>Product description Product (Injection mortar)</p>	

Table A1: Material (Threaded rod)

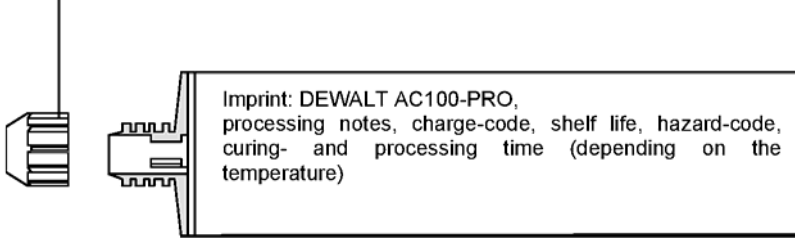
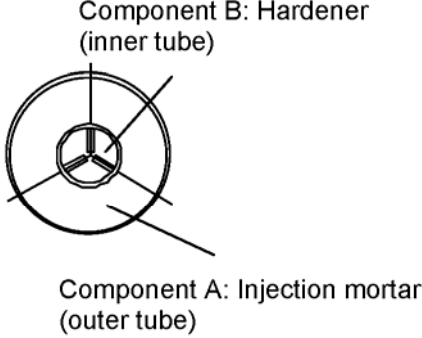
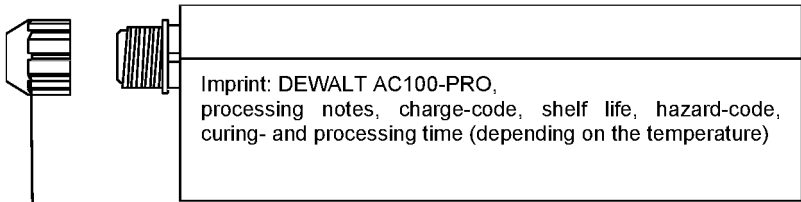
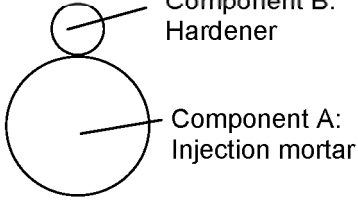
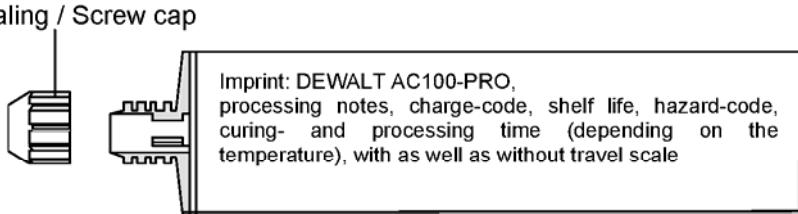
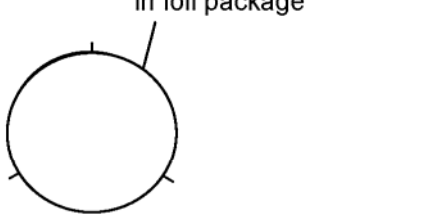

Part	Designation	Material
Steel, zinc plated $\geq 5 \mu\text{m}$ acc. to EN ISO 4042:1999 or Steel, hot-dip galvanised $\geq 40 \mu\text{m}$ acc. to EN ISO 1461:2009		
1	Anchor rod	Steel acc. EN 10087:1998 or EN 10263:2001 Property class 4.6, 5.8, 8.8 acc. EN 1993-1-8:2005+AC:2009 $A_5 > 8\%$ fracture elongation, $f_{uk} = f_{ub}$ $f_{yk} = f_{yb}$
2	Hexagon nut EN ISO 4032 :2012	Steel acc. EN 10087:1998 or EN 10263:2001 Property class 4 (for class 4.6 rod) Property class 5 (for class 5.8 rod) Property class 8 (for class 8.8 rod) EN ISO 898-2:2012
3	Washer EN ISO 7089:2000, EN ISO 7093:2000 or EN ISO 7094:2000	Steel, zinc plated or hot-dip galvanised
Stainless steel A4		
1	Anchor rod	Material 1.4401 / 1.4404 / 1.4571, EN 10088-1:2005, > M24: Property class 50 EN ISO 3506-1:2009 \leq M24: Property class 70 EN ISO 3506-1:2009 $A_5 > 8\%$ fracture elongation, $f_{uk} = R_{m,min}$ $f_{yk} = R_{p0.2,min}$
2	Hexagon nut EN ISO 4032:2012	Material 1.4401 / 1.4404 / 1.4571 EN 10088-1:2005, > M24: Property class 50 (for class 50 rod) EN ISO 3506-2:2009 \leq M24: Property class 70 (for class 70 rod) EN ISO 3506-2:2009
3	Washer, EN ISO 887, EN ISO 7089, EN ISO 7093, or EN ISO 7094	Material 1.4401, 1.4404 or 1.4571, EN 10088-1:2005
High corrosion resistance steel HCR		
1	Anchor rod	Material 1.4529 / 1.4565, EN 10088-1:2005, > M24: Property class 50 EN ISO 3506-1:2009 \leq M24: Property class 70 EN ISO 3506-1:2009 $A_5 > 8\%$ fracture elongation, $f_{uk} = R_{m,min}$ $f_{yk} = R_{p0.2,min}$
2	Hexagon nut EN ISO 4032 :2012	Material 1.4529 / 1.4565 EN 10088-1:2005, > M24: Property class 50 (for class 50 rod) EN ISO 3506-2:2009 \leq M24: Property class 70 (for class 70 rod) EN ISO 3506-2:2009
3	Washer EN ISO 7089:2000, EN ISO 7093:2000 or EN ISO 7094:2000	Material 1.4529 / 1.4565, EN 10088-1:2005

Commercial standard rod with:

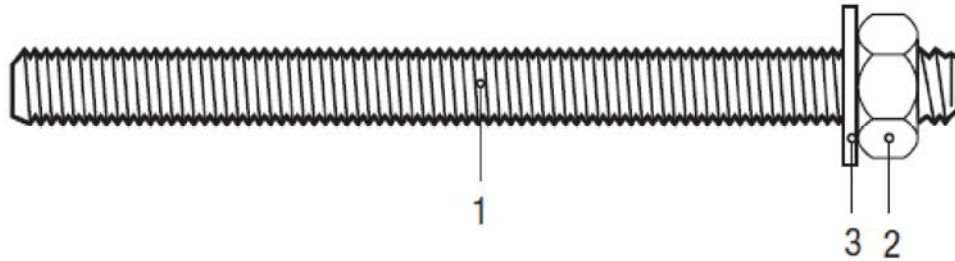
- Materials, dimensions and mechanical properties acc. to Table A1
- Inspection certificate 3.1 acc. to EN 10204:2004
- Marking of embedment depth

DEWALT AC100-PRO Injection resin with anchor rod for concrete

Annex A3

Product description
Materials (Threaded rod)

Table A2: Material (Rebar)



- Minimum value of related rip area $f_{R,min}$ according to EN 1992-1-1:2009+AC:2010
- Rip height of the bar shall be in the range $0,05d \leq h \leq 0,07d$
(d: Nominal diameter of the rebar, h: Rip height of the bar)

Reinforcing bar

1	Rebar according EN 1992-1-1:2009+AC:2010, Annex C	Bars and de-coiled rods class B or C f_{yk} and k according to NDP or NCL of EN 1992-1-1/NA:2013 $f_{uk} = f_{tk} = k \cdot f_{yk}$
----------	--	---

Table A3: Material (Internal threaded sleeve)

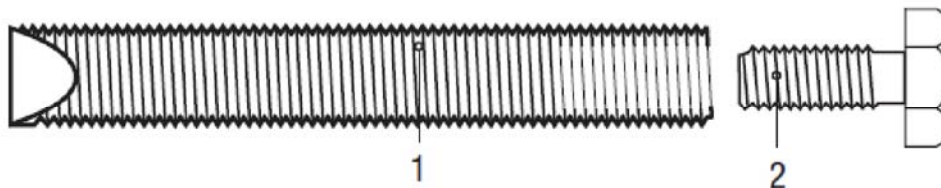

Part	Designation	Material
Steel, zinc plated $\geq 5 \mu\text{m}$ acc. to EN ISO 4042:1999		
1	Internal threaded sleeve	Steel, EN 10087:2001 or EN 10263:2001 Property class 5.8, EN 1993-1-8:2005+AC:2009
2	Corresponding steel screw	Steel screws property class 5.8 or 8.8, EN ISO 898-1:2013 Zinc plated $\geq 5 \mu\text{m}$ acc. EN ISO 4042:1999
Stainless steel A4		
1	Internal threaded sleeve	Material 1.4401 / 1.4404 / 1.4571, EN 10088-1: 2005, Property class 70, EN ISO 3506-1:2009
2	Corresponding steel screw	Steel screws property class 50 or 70 EN ISO 3506-1:2009 Stainless steel 1.4401, 1.4404, 1.4571 EN 10088-1:2005
High corrosion resistance steel HCR		
1	Internal threaded sleeve	Material 1.4529 / 1.4565, EN 10088-1:2005, Property class 70, EN ISO 3506-1:2009
2	Corresponding steel screw	Steel screws property class 50 or 70 EN ISO 3506-1:2009 High corrosion resistance steel 1.4529, 1.4565 EN 10088-1:2005

DEWALT AC100-PRO Injection resin with anchor rod for concrete

Annex A4

Product description

Materials (Reinforcing bar)
Materials (Internal threaded sleeve)

Specifications of intended use

Anchorage subject to:

- Static and quasi-static loads: Threaded rod M8 to M30, Rebar Ø8 to Ø32, Internal threaded rod M8 to M20.
- Seismic action for Performance Category C1: Threaded rod M12 to M30, Rebar Ø12 to Ø32.

Base materials:

- Reinforced or unreinforced normal weight concrete according to EN 206-1:2000.
- Strength classes C20/25 to C50/60 according to EN 206-1:2000.
- Uncracked concrete: Threaded rod M8 to M30, Rebar Ø8 to Ø32, Internal threaded rod M8 to M20.
- Cracked concrete: Threaded rod M12 to M30, Rebar Ø12 to Ø32, Internal threaded rod M8 to M20.

Temperature Range:

- I: - 40 °C to +40 °C (max long term temperature +24 °C and max short term temperature +40 °C)
- II: - 40 °C to +80 °C (max long term temperature +50 °C and max short term temperature +80 °C)
- III: - 40 °C to +120 °C (max long term temperature +72 °C and max short term temperature +120 °C)

Use conditions (Environmental conditions):

- Structures subject to dry internal conditions (zinc coated steel, stainless steel or high corrosion resistant steel).
- Structures subject to external atmospheric exposure (including industrial and marine environment) and to permanently damp internal condition, if no particular aggressive conditions exist (stainless steel or high corrosion resistant steel).
- Structures subject to external atmospheric exposure and to permanently damp internal condition, if other particular aggressive conditions exist (high corrosion resistant steel).

Note: Particular aggressive conditions are e.g. permanent, alternating immersion in seawater or the splash zone of seawater, chloride atmosphere of indoor swimming pools or atmosphere with extreme chemical pollution (e.g. in desulphurization plants or road tunnels where de-icing materials are used).

Design:

- Verifiable calculation notes and drawings are prepared taking account of the loads to be anchored. The position of the anchor is indicated on the design drawings (e.g. position of the anchor relative to reinforcement or to supports, etc.).
- Anchorages are designed under the responsibility of an engineer experienced in anchorages and concrete work.
- Anchorages under static or quasi-static actions are designed in accordance with:
 - EOTA Technical Report TR 029 "Design of bonded anchors", Edition September 2010 or
 - CEN/TS 1992-4:2009
- Anchorages under seismic actions (cracked concrete) are designed in accordance with:
 - EOTA Technical Report TR 045 "Design of Metal Anchors under Seismic Action", Edition February 2013
 - Anchorages shall be positioned outside of critical regions (e.g. plastic hinges) of the concrete structure.
 - Fastenings in stand-off installation or with a grout layer are not allowed.

Installation:

- Dry or wet concrete.
- Flooded holes (not sea water) for drill diameters $d_0 \leq 18$ mm.
- Hole drilling by hammer drill mode.
- Overhead installation allowed.
- Anchor installation carried out by appropriately qualified personnel and under the supervision of the person responsible for technical matters of the site.

DEWALT AC100-PRO Injection resin with anchor rod for concrete

Annex B1

Intended use
Specifications

Table B1: Installation parameters for threaded rod

Anchor size		M 8	M 10	M 12	M 16	M 20	M 24	M 27	M 30	
Nominal drill hole diameter	d_0 [mm]	10	12	14	18	24	28	32	35	
Effective anchorage depth	$h_{ef,min}$ [mm]	60	60	70	80	90	96	108	120	
	$h_{ef,max}$ [mm]	160	200	240	320	400	480	540	600	
Diameter of clearance hole in the fixture	d_f [mm]	9	12	14	18	22	26	30	33	
Diameter of steel brush	d_b [mm]	12	14	16	20	26	30	34	37	
Torque moment	T_{inst} [Nm]	10	20	40	80	120	160	180	200	
Thickness of fixture	$t_{fix,min}$ [mm]	0								
	$t_{fix,max}$ [mm]	1500								
Minimum thickness of member	h_{min} [mm]	$h_{ef} + 30$ mm ≥ 100 mm			$h_{ef} + 2 \cdot d_0$					
Minimum spacing	s_{min} [mm]	40	50	60	80	100	120	135	150	
Minimum edge distance	c_{min} [mm]	40	50	60	80	100	120	135	150	

Table B2: Installation parameters for rebar

Rebar size		Ø 8	Ø 10	Ø 12	Ø 14	Ø 16	Ø 20	Ø 24	Ø 25	Ø 28	Ø 32	
Nominal drill hole diameter	d_0 [mm]	12	14	16	18	20	24	28	32	35	37	
Effective anchorage depth	$h_{ef,min}$ [mm]	60	60	70	75	80	90	96	100	112	128	
	$h_{ef,max}$ [mm]	160	200	240	280	320	400	480	480	540	640	
Diameter of steel brush	d_b [mm]	14	16	18	20	22	26	30	34	37	40	
Minimum thickness of member	h_{min} [mm]	$h_{ef} + 30$ mm ≥ 100 mm			$h_{ef} + 2 \cdot d_0$							
Minimum spacing	s_{min} [mm]	40	50	60	70	80	100	120	125	140	160	
Minimum edge distance	c_{min} [mm]	40	50	60	70	80	100	120	125	140	160	

Table B3: Installation parameters for internal threaded sleeves

Internal thread size		M 8	M 10	M 12	M 16	M 20
External diameter size	[mm]	12	16	20	24	30
Nominal drill hole diameter	d_0 [mm]	14	18	24	28	35
Effective anchorage depth	h_{ef} [mm]	80	90	110	150	200
Diameter of clearance hole in the fixture	d_f [mm]	9	12	14	18	22
Diameter of steel brush	d_b [mm]	16	20	26	30	37
Torque moment	T_{inst} [Nm]	10	20	40	80	120
Min.- max. screw in length	l_1 [mm]	8-35	10-45	12-55	16-75	20-85
Minimum thickness of member	h_{min} [mm]	110	130	160	210	270
Minimum spacing	s_{min} [mm]	60	80	100	120	150
Minimum edge distance	c_{min} [mm]	60	80	100	120	150

DEWALT AC100-PRO Injection resin with anchor rod for concrete

Annex B2

Intended use
Installation parameters

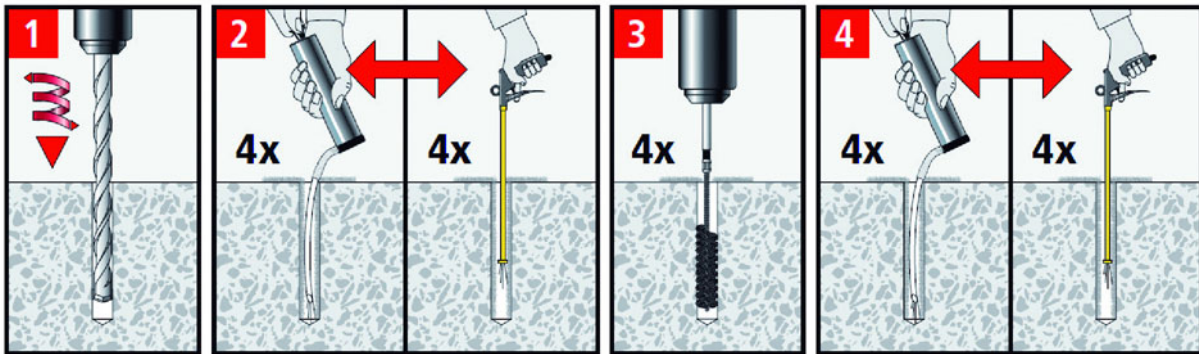

1. Drill with hammer drill a hole into the base material to the size and embedment depth required by the selected anchor (Table B1, Table B2 or Table B3).
2. Before cleaning remove standing water out of the drill hole. Starting from the bottom or back of the bore hole, blow the hole clean with compressed air (min. 6 bar) or a hand pump (Annex B5) a minimum of four times. If the bore hole ground is not reached an extension shall be used.

The hand-pump can be used for anchor sizes up to bore hole diameter 20 mm.

For bore holes larger than 20 mm or deeper than 240 mm, compressed air (min. 6 bar) **must** be used.

3. Check brush diameter (Table B5) and attach the brush to a drilling machine or a battery screwdriver. Starting from the bottom or back of the bore hole, brush the hole with an appropriate sized wire brush $> d_{b,min}$ (Table B5) a minimum of four times. If the bore hole ground is not reached with the brush, a brush extension shall be used (Table B5).

4. Finally blow the hole clean again with compressed air (min. 6 bar) or a hand pump (Annex B5) a minimum of four times. If the bore hole ground is not reached an extension shall be used.

The hand-pump can be used for anchor sizes up to bore hole diameter 20 mm.

For bore holes larger than 20 mm or deeper than 240 mm, compressed air (min. 6 bar) **must** be used.

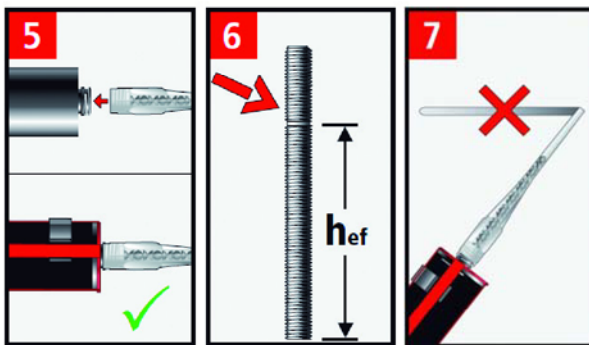

5. Attach a supplied static-mixing nozzle to the cartridge and load the cartridge into the correct dispensing tool. Cut off the foil tube clip before use. For every working interruption longer than the recommended working time (Table B45) as well as for new cartridges, a new static-mixer shall be used.
6. Prior to inserting the anchor rod into the filled bore hole, the position of the embedment depth shall be marked on the anchor rods.
7. Prior to dispensing into the anchor hole, squeeze out separately a minimum of three full strokes and discard non-uniformly mixed adhesive components until the mortar shows a consistent grey colour.

DEWALT AC100-PRO Injection resin with anchor rod for concrete

Annex B3

Intended use
Installation instructions

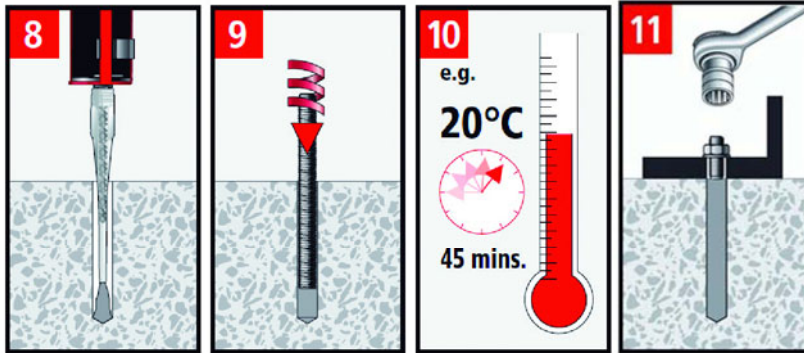

- 8.** Starting from the bottom or back of the cleaned anchor hole fill the hole up to approximately two-thirds with adhesive. Slowly withdraw the static mixing nozzle as the hole fills to avoid creating air pockets. For embedment larger than 190 mm an extension nozzle shall be used. For overhead and horizontal installation in bore holes larger than \varnothing 20 mm a piston plug and extension nozzle (Annex B5) shall be used. Observe the gel-/ working times given in Table B4. Injecting the mortar in with water filled drill holes is allowed for drill diameters smaller than 18 mm.
- 9.** Push the threaded rod or reinforcing bar into the anchor hole while turning slightly to ensure positive distribution of the adhesive until the embedment depth is reached. The anchor should be free of dirt, grease, oil or other foreign material.
- Be sure that the anchor is fully seated at the bottom of the hole that the annular gap is completely filled with mortar and that excess mortar is visible at the top of the hole. If these requirements are not maintained, the application shall not be loaded and has to be renewed.
- 10.** Allow the adhesive to cure to the specified time prior to applying any load or torque. Do not move or load the anchor until it is fully cured (attend Table B4).
- 11.** After full curing, the add-on part can be installed with the max. torque moment (Table B1 or Table B3) by using a calibrated torque wrench.

Table B4: Minimum curing time

Concrete temperature	Gelling- / working time	Minimum curing time in dry concrete ²⁾
≥ -10 °C ¹⁾	90 min	24 h
≥ -5 °C	90 min	14 h
≥ 0 °C	45 min	7 h
$\geq +5$ °C	25 min	2 h
$\geq +10$ °C	15 min	80 min
$\geq +20$ °C	6 min	45 min
$\geq +30$ °C	4 min	25 min
$\geq +35$ °C	2 min	20 min
$\geq +40$ °C	1,5 min	15 min

¹⁾ Cartridge temperature **must** be at min. +15°C

²⁾ In wet concrete the curing time **must** be doubled

DEWALT AC100-PRO Injection resin with anchor rod for concrete

Annex B4

Intended use
Installation instructions (continuation)

Steel brush and extension

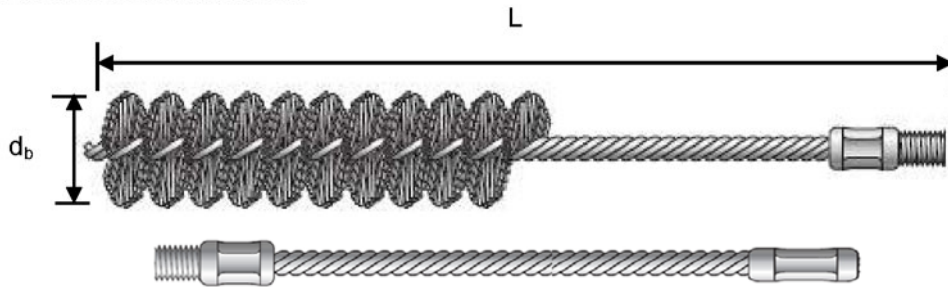
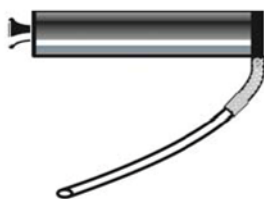

Table B5: Parameter cleaning and setting tools

Threaded rod [mm]	Rebar [mm]	Drill bit $\varnothing d_0$ [mm]	Brush diameters		Piston plug denom. (\varnothing) [mm]
			nominal d_b [mm]	minimum $d_{b,min}$ [mm]	
M8		10	12	10,5	-
M10	8	12	14	12,5	-
M12	10	14	16	14,5	-
	12	16	18	16,5	-
M16	14	18	20	18,5	-
	16	20	22	20,5	-
M20	20	24	26	24,5	#24 (22)
M24	24	28	30	28,5	#28 (27)
M27	25	32	34	32,5	#28 (29)
M30	28	35	37	35,5	#35 (34)
	32	37	40	37,5	#35 (36)



Hand pump (volume 750 ml)
Drill bit diameter (d_0): 10 mm to 20 mm



Recommended compressed air tool (min 6 bar)
Drill bit diameter (d_0): 10 mm to 37 mm



Piston plug for overhead or horizontal installation
Drill bit diameter (d_0): 24 mm to 37 mm

DEWALT AC100-PRO Injection resin with anchor rod for concrete

Annex B5

Intended use
Cleaning and setting tools

Table C1: Design according to TR029											
Characteristic values for tension loads in uncracked concrete											
Anchor size threaded rod				M 8	M 10	M 12	M 16	M 20	M 24	M 27	M 30
Steel failure											
Characteristic tension resistance		$N_{Rk,s}$	[kN]	See TR029, Chapter 5.2.2.2., Eq. (5.1), $N_{Rk,s} = A_s \cdot f_{uk}$							
Stressed cross section		A_s	[mm ²]	36,6	58,0	84,3	156,7	244,8	352,5	459,4	560,6
Combined pullout and concrete cone failure											
<i>Characteristic bond resistance in non-cracked concrete C20/25</i>											
dry and wet concrete	Temp. range I: 40°C/24°C	$\tau_{Rk,uncr}$	[N/mm ²]	11	13	13	13	13	12	11	9,5
	Temp. range II: 80°C/50°C	$\tau_{Rk,uncr}$	[N/mm ²]	8,0	9,5	9,5	9,5	9,5	9,0	8,0	7,0
	Temp. range III: 120°C/72°C	$\tau_{Rk,uncr}$	[N/mm ²]	5,5	6,5	6,5	6,5	6,5	6,0	5,5	5,0
flooded bore hole	Temp. range I: 40°C/24°C	$\tau_{Rk,uncr}$	[N/mm ²]	8,0	9,5	9,5	9,5	No Performance Determined (NPD)			
	Temp. range II: 80°C/50°C	$\tau_{Rk,uncr}$	[N/mm ²]	6,0	7,0	7,0	7,0				
	Temp. range III: 120°C/72°C	$\tau_{Rk,uncr}$	[N/mm ²]	4,5	5,5	5,5	5,5				
Increasing factors for non-cracked concrete ψ_c		C30/37		1,04							
		C40/50		1,08							
		C50/60		1,10							
Splitting failure											
Characteristic edge distance		$c_{cr,sp}$	[mm]	$1,0 \cdot h_{ef} \leq 2 \cdot h_{ef} \left(2,5 - \frac{h}{h_{ef}} \right) \leq 2,4 \cdot h_{ef}$							
Characteristic spacing		$s_{cr,sp}$	[mm]	$2 \cdot c_{cr,sp}$							
Installation safety factor (dry and wet concrete)		γ_2		1,0	1,2						
Installation safety factor (flooded bore hole)		γ_2		1,4					No Performance Determined (NPD)		
DEWALT AC100-PRO Injection resin with anchor rod for concrete										Annex C1	
Performances Application with threaded rod Characteristic values for tension loads in uncracked concrete						TR 029					

Table C2: Design according to TR029
Characteristic values for tension loads in cracked concrete

Anchor size threaded rod				M 12	M 16	M 20	M 24	M 27	M 30
Steel failure									
Characteristic tension resistance		$N_{Rk,s}$	[kN]	See TR029, Chapter 5.2.2.2., Eq. (5.1), $N_{Rk,s} = A_s \cdot f_{uk}$					
Stressed cross section		A_s	[mm ²]	84,3	156,7	244,8	352,5	459,4	560,6
Combined pullout and concrete cone failure									
<i>Characteristic bond resistance in cracked concrete C20/25</i>									
dry and wet concrete	Temp. range I: 40°C/24°C	$\tau_{Rk,cr}$	[N/mm ²]	5,5	5,5	5,5	5,5	6,5	6,5
	Temp. range II: 80°C/50°C	$\tau_{Rk,cr}$	[N/mm ²]	4,0	4,0	4,0	4,0	4,5	4,5
	Temp. range III: 120°C/72°C	$\tau_{Rk,cr}$	[N/mm ²]	3,0	3,0	3,0	3,0	3,5	3,5
flooded bore hole	Temp. range I: 40°C/24°C	$\tau_{Rk,cr}$	[N/mm ²]	6,0	6,0	No Performance Determined (NPD)			
	Temp. range II: 80°C/50°C	$\tau_{Rk,cr}$	[N/mm ²]	4,5	4,5				
	Temp. range III: 120°C/72°C	$\tau_{Rk,cr}$	[N/mm ²]	3,5	3,5				
Increasing factors for cracked concrete ψ_c		C30/37		1,04					
		C40/50		1,08					
		C50/60		1,10					
Installation safety factor (dry and wet concrete)		γ_2		1,2					
Installation safety factor (flooded bore hole)		γ_2		1,4		No Performance Determined (NPD)			

DEWALT AC100-PRO Injection resin with anchor rod for concrete

Annex C2

Performances

Application with threaded rod
Characteristic values for tension loads in cracked concrete

TR 029

Table C3: Design according to TR029
Characteristic values for shear loads in cracked and uncracked concrete

Anchor size threaded rod			M 8	M 10	M 12	M 16	M 20	M 24	M 27	M 30
Steel failure without lever arm										
Characteristic tension resistance	$V_{Rk,s}$	[kN]	See TR029, Chapter 5.2.3.2., Eq. (5.5), $V_{Rk,s}=0,5 \cdot A_s \cdot f_{uk}$							
Stressed cross section	A_s	[mm ²]	36,6	58,0	84,3	156,7	244,8	352,5	459,4	560,6
Steel failure with lever arm										
Characteristic bending resistance	$M^0_{Rk,s}$	[Nm]	See TR029, Chapter 5.2.3.2., Eq. (5.6 b), $M^0_{Rk,s}=1,2 \cdot W_{el} \cdot f_{uk}$							
Elastic section modulus	W_{el}	[mm ³]	31,2	62,3	109,1	276,6	540,3	933,4	1389	1872
Concrete pryout failure										
Factor k in Equation (5.7) of Technical Report TR 029 for the design of Bonded Anchors			2,0							
Installation safety factor		γ_2	1,0							
Concrete edge failure										
See Section 5.2.3.4 of Technical Report TR 029 for the design of Bonded Anchors										
Installation safety factor		γ_2	1,0							

DEWALT AC100-PRO Injection resin with anchor rod for concrete

Annex C3

Performances

Application with threaded rod
Characteristic values for shear loads in cracked and uncracked concrete

TR 029

Table C4: Design according to TR029 Characteristic values for tension loads in uncracked concrete													
Anchor size reinforcing bar				Ø 8	Ø 10	Ø 12	Ø 14	Ø 16	Ø 20	Ø 24	Ø 25	Ø 28	Ø 32
Steel failure													
Characteristic tension resistance		$N_{Rk,s}$	[kN]	See TR029, Chapter 5.2.2.2., Eq. (5.1), $N_{Rk,s} = A_s \cdot f_{uk}$									
Stressed cross section		A_s	[mm ²]	50,3	78,5	113,1	153,9	201,1	314,2	452,4	490,9	615,8	804,2
Combined pullout and concrete cone failure													
<i>Characteristic bond resistance in uncracked concrete C20/25</i>													
dry and wet concrete	Temp. range I: 40°C/24°C	$\tau_{Rk,uncr}$	[N/mm ²]	11	13	13	13	13	13	11,5	11,5	10,5	9,0
	Temp. range II: 80°C/50°C	$\tau_{Rk,uncr}$	[N/mm ²]	8,0	9,5	9,5	9,5	9,5	9,5	8,5	8,5	7,5	6,5
	Temp. range III: 120°C/72°C	$\tau_{Rk,uncr}$	[N/mm ²]	5,5	6,5	6,5	6,5	6,5	6,5	6,0	6,0	5,0	4,5
flooded bore hole	Temp. range I: 40°C/24°C	$\tau_{Rk,uncr}$	[N/mm ²]	8,0	9,5	9,5	9,5	9,5	No Performance Determined (NPD)				
	Temp. range II: 80°C/50°C	$\tau_{Rk,uncr}$	[N/mm ²]	6,0	7,0	7,0	7,0	7,0					
	Temp. range III: 120°C/72°C	$\tau_{Rk,uncr}$	[N/mm ²]	4,5	5,5	5,5	5,5	5,5					
Increasing factors for non-cracked concrete ψ_c		C30/37							1,04				
		C40/50							1,08				
		C50/60							1,10				
Splitting failure													
Characteristic edge distance		$C_{cr,sp}$	[mm]	$1,0 \cdot h_{ef} \leq 2 \cdot h_{ef} \left(2,5 - \frac{h}{h_{ef}} \right) \leq 2,4 \cdot h_{ef}$									
Characteristic spacing		$S_{cr,sp}$	[mm]	$2 \cdot C_{cr,sp}$									
Installation safety factor (dry and wet concrete)		γ_2		1,0	1,2								
Installation safety factor (flooded bore hole)		γ_2		1,4					No Performance Determined (NPD)				
DEWALT AC100-PRO Injection resin with anchor rod for concrete										Annex C4			
Performances Application with reinforcing bar Characteristic values for tension loads in uncracked concrete			TR 029										

Table C5: Design according to TR029
Characteristic values for tension loads in cracked concrete

Anchor size reinforcing bar				Ø 12	Ø 14	Ø 16	Ø 20	Ø 24	Ø 25	Ø 28	Ø 32
Steel failure											
Characteristic tension resistance		$N_{Rk,s}$	[kN]	See TR029, Chapter 5.2.2.2., Eq. (5.1), $N_{Rk,s} = A_s \cdot f_{uk}$							
Stressed cross section		A_s	[mm ²]	113,1	153,9	201,1	314,2	452,4	490,9	615,8	804,2
Combined pullout and concrete cone failure											
<i>Characteristic bond resistance in cracked concrete C20/25</i>											
dry and wet concrete	Temp. range I: 40°C/24°C	$\tau_{Rk,cr}$	[N/mm ²]	5,5	5,5	5,5	5,5	5,5	5,5	6,5	6,5
	Temp. range II: 80°C/50°C	$\tau_{Rk,cr}$	[N/mm ²]	4,0	4,0	4,0	4,0	4,0	4,0	4,5	4,5
	Temp. range III: 120°C/72°C	$\tau_{Rk,cr}$	[N/mm ²]	3,0	3,0	3,0	3,0	3,0	3,0	3,5	3,5
flooded bore hole	Temp. range I: 40°C/24°C	$\tau_{Rk,cr}$	[N/mm ²]	6,0	6,0	6,0	No Performance Determined (NPD)				
	Temp. range II: 80°C/50°C	$\tau_{Rk,cr}$	[N/mm ²]	4,5	4,5	4,5					
	Temp. range III: 120°C/72°C	$\tau_{Rk,cr}$	[N/mm ²]	3,5	3,5	3,5					
Increasing factors for cracked concrete ψ_c		C30/37		1,04							
		C40/50		1,08							
		C50/60		1,10							
Installation safety factor (dry and wet concrete)		γ_2		1,2							
Installation safety factor (flooded bore hole)		γ_2		1,4				No Performance Determined (NPD)			

DEWALT AC100-PRO Injection resin with anchor rod for concrete

Annex C5

Performances

Application with reinforcing bar
Characteristic values for tension loads in cracked concrete

TR 029

Table C6: Design according to TR029
Characteristic values for shear loads in cracked and uncracked concrete

Anchor size reinforcing bar			Ø 8	Ø 10	Ø 12	Ø 14	Ø 16	Ø 20	Ø 24	Ø 25	Ø 28	Ø 32
Steel failure without lever arm												
Characteristic tension resistance	$V_{Rk,s}$	[kN]	See TR029, Chapter 5.2.3.2., Eq. (5.5), $V_{Rk,s}=0,5 \cdot A_s \cdot f_{uk}$									
Stressed cross section	A_s	[mm ²]	50,3	78,5	113,1	153,9	201,1	314,2	452,4	490,9	615,8	804,2
Steel failure with lever arm												
Characteristic bending resistance	$M_{Rk,s}^0$	[Nm]	See TR029, Chapter 5.2.3.2., Eq. (5.6 b), $M_{Rk,s}^0=1,2 \cdot W_{el} \cdot f_{uk}$									
Elastic section modulus	W_{el}	[mm ³]	50,3	98,2	169,6	269,4	402,1	785,4	1357	1534	2155	3217
Concrete pryout failure												
Factor k in Equation (5.7) of Technical Report TR 029 for the design of bonded anchors			2,0									
Installation safety factor	γ_2		1,0									
Concrete edge failure												
<i>See Section 5.2.3.4 of Technical Report TR 029 for the design of Bonded Anchors</i>												
Installation safety factor	γ_2		1,0									

DEWALT AC100-PRO Injection resin with anchor rod for concrete

Annex C6

Performances

Application with reinforcing bar
Characteristic values for shear loads in cracked and uncracked concrete

TR 029

Table C7: Design according to TR029
Characteristic values for tension loads in uncracked concrete

Anchor size internal threaded sleeve				M 8	M 10	M 12	M 16	M 20
External diameter				12	16	20	24	30
Effective anchorage depth h_{ef} [mm]				80	90	110	150	200
Steel failure (internal threaded sleeve)								
Characteristic tension resistance, Zinc plated		$N_{Rk,s}$	[kN]	19,5	42,8	71,1	83,7	135,7
Characteristic tension resistance, Stainless steel A4		$N_{Rk,s}$	[kN]	24,2	53,1	88,1	103,8	135,7
Steel failure (threaded rod)								
Characteristic tension resistance		$N_{Rk,s}$	[kN]	See TR029, Chapter 5.2.2.2., Eq. (5.1), $N_{Rk,s} = A_s \cdot f_{uk}$				
Stressed cross section		A_s	[mm ²]	36,6	58,0	84,3	156,7	244,8
Combined pullout and concrete cone failure								
<i>Characteristic bond resistance in non-cracked concrete C20/25</i>								
dry and wet concrete	Temp. range I: 40°C/24°C	$\tau_{Rk,uncr}$	[N/mm ²]	13	13	13	12	9,5
	Temp. range II: 80°C/50°C	$\tau_{Rk,uncr}$	[N/mm ²]	9,5	9,5	9,5	9,0	7,0
	Temp. range III: 120°C/72°C	$\tau_{Rk,uncr}$	[N/mm ²]	6,5	6,5	6,5	6,0	5,0
flooded bore hole	Temp. range I: 40°C/24°C	$\tau_{Rk,uncr}$	[N/mm ²]	9,5	9,5	No Performance Determined (NPD)		
	Temp. range II: 80°C/50°C	$\tau_{Rk,uncr}$	[N/mm ²]	7,0	7,0			
	Temp. range III: 120°C/72°C	$\tau_{Rk,uncr}$	[N/mm ²]	5,5	5,5			
Increasing factors for non-cracked concrete ψ_c		C30/37		1,04				
		C40/50		1,08				
		C50/60		1,10				
Splitting failure								
Characteristic edge distance		$c_{cr,sp}$	[mm]	$1,0 \cdot h_{ef} \leq 2 \cdot h_{ef} \left(2,5 - \frac{h}{h_{ef}} \right) \leq 2,4 \cdot h_{ef}$				
Characteristic spacing		$s_{cr,sp}$	[mm]	$2 \cdot c_{cr,sp}$				
Installation safety factor (dry and wet concrete)		γ_2		1,2				
Installation safety factor (flooded bore hole)		γ_2		1,4		No Performance Determined (NPD)		

DEWALT AC100-PRO Injection resin with anchor rod for concrete

Annex C7

Performances

Application with internal threaded sleeve
Characteristic values for tension loads in uncracked concrete

TR 029

Table C8: Design according to TR029
Characteristic values for tension loads in cracked concrete

Anchor size internal threaded sleeve				M 8	M 10	M 12	M 16	M 20
External diameter				12	16	20	24	30
Effective anchorage depth h_{ef} [mm]				80	90	110	150	200
Steel failure (internal threaded sleeve)								
Characteristic tension resistance, Zinc plated		$N_{Rk,s}$	[kN]	19,5	42,8	71,1	83,7	135,7
Characteristic tension resistance, A4 steel		$N_{Rk,s}$	[kN]	24,2	53,1	88,1	103,8	135,7
Steel failure (threaded rod)								
Characteristic tension resistance		$N_{Rk,s}$	[kN]	See TR029, Chapter 5.2.2.2., Eq. (5.1), $N_{Rk,s} = A_s \cdot f_{uk}$				
Stressed cross section		A_s	[mm ²]	36,6	58,0	84,3	156,7	244,8
Combined pullout and concrete cone failure								
<i>Characteristic bond resistance in cracked concrete C20/25</i>								
dry and wet concrete	Temp. range I: 40°C/24°C	$\tau_{Rk,cr}$	[N/mm ²]	5,5	5,5	5,5	5,5	6,5
	Temp. range II: 80°C/50°C	$\tau_{Rk,cr}$	[N/mm ²]	4,0	4,0	4,0	4,0	4,5
	Temp. range III: 120°C/72°C	$\tau_{Rk,cr}$	[N/mm ²]	3,0	3,0	3,0	3,0	3,5
flooded bore hole	Temp. range I: 40°C/24°C	$\tau_{Rk,cr}$	[N/mm ²]	6,0	6,0	No Performance Determined (NPD)		
	Temp. range II: 80°C/50°C	$\tau_{Rk,cr}$	[N/mm ²]	4,5	4,5			
	Temp. range III: 120°C/72°C	$\tau_{Rk,cr}$	[N/mm ²]	3,5	3,5			
Increasing factors for cracked concrete ψ_c		C30/37		1,04				
		C40/50		1,08				
		C50/60		1,10				
Installation safety factor (dry and wet concrete)		γ_2		1,2				
Installation safety factor (flooded bore hole)		γ_2		1,4		No Performance Determined (NPD)		

DEWALT AC100-PRO Injection resin with anchor rod for concrete

Annex C8

Performances

Application with internal threaded sleeve
Characteristic values for tension loads in cracked concrete

TR 029

Table C9: Design according to TR029
Characteristic values for shear loads in cracked and uncracked concrete

Anchor size internal threaded sleeve			M 8	M 10	M 12	M 16	M 20
External diameter			12	16	20	24	30
Effective anchorage depth h_{ef} [mm]			80	90	110	150	200
Steel failure without lever arm (internal threaded sleeve)							
Characteristic shear resistance, Zinc plated	$V_{Rk,s}$	[kN]	9,7	21,4	35,5	41,9	67,9
Characteristic shear resistance, A4 steel	$V_{Rk,s}$	[kN]	12,1	26,5	44,1	51,9	67,9
Steel failure without lever arm (threaded rod)							
Characteristic tension resistance	$V_{Rk,s}$	[kN]	See TR029, Chapter 5.2.3.2., Eq. (5.5), $V_{Rk,s}=0,5 \cdot A_s \cdot f_{uk}$				
Stressed cross section	A_s	[mm ²]	36,6	58,0	84,3	156,7	244,8
Steel failure with lever arm (internal threaded sleeve)							
Characteristic bending moment, Zinc plated	$M^0_{Rk,s}$	[Nm]	46,5	131,8	267,2	405,7	824,5
Characteristic bending moment, A4 steel	$M^0_{Rk,s}$	[Nm]	57,7	163,4	331,3	503,0	824,5
Steel failure with lever arm (threaded rod)							
Characteristic bending resistance	$M^0_{Rk,s}$	[Nm]	See TR029, Chapter 5.2.3.2., Eq. (5.6 b), $M^0_{Rk,s}=1,2 \cdot W_{el} \cdot f_{uk}$				
Elastic section modulus	W_{el}	[mm ³]	31,2	62,3	109,1	276,6	540,3
Concrete pryout failure							
Factor k in Equation (5.7) of Technical Report TR 029 for the design of Bonded Anchors			2,0				
Installation safety factor	γ_2		1,0				
Concrete edge failure							
See Section 5.2.3.4 of Technical Report TR 029 for the design of Bonded Anchors							
Installation safety factor	γ_2		1,0				

DEWALT AC100-PRO Injection resin with anchor rod for concrete

Annex C9

Performances

Application with internal threaded sleeve
Characteristic values for shear loads in cracked and uncracked concrete

TR 029

Table C10: Design according to CEN/TS1992-4
Characteristic values for tension loads in uncracked concrete

Anchor size threaded rod			M 8	M 10	M 12	M 16	M 20	M 24	M 27	M 30	
Steel failure											
Characteristic tension resistance	$N_{Rk,s}$	[kN]	See CEN/TS 1992-4-5, Chapter 6.2.2, $N_{Rk,s} = A_s \cdot f_{uk}$								
Stressed cross section	A_s	[mm ²]	36,6	58,0	84,3	156,7	244,8	352,5	459,4	560,6	
Combined pullout and concrete cone failure											
<i>Characteristic bond resistance in non-cracked concrete C20/25</i>											
dry and wet concrete	Temp. range I: 40°C/24°C	$\tau_{Rk,ucr}$	[N/mm ²]	11	13	13	13	13	12	11	9,5
	Temp. range II: 80°C/50°C	$\tau_{Rk,ucr}$	[N/mm ²]	8,0	9,5	9,5	9,5	9,5	9,0	8,0	7,0
	Temp. range III: 120°C/72°C	$\tau_{Rk,ucr}$	[N/mm ²]	5,5	6,5	6,5	6,5	6,5	6,0	5,5	5,0
flooded bore hole	Temp. range I: 40°C/24°C	$\tau_{Rk,ucr}$	[N/mm ²]	8,0	9,5	9,5	9,5	No Performance Determined (NPD)			
	Temp. range II: 80°C/50°C	$\tau_{Rk,ucr}$	[N/mm ²]	6,0	7,0	7,0	7,0				
	Temp. range III: 120°C/72°C	$\tau_{Rk,ucr}$	[N/mm ²]	4,5	5,5	5,5	5,5				
Increasing factors for non-cracked concrete ψ_c	C30/37		1,04								
	C40/50		1,08								
	C50/60		1,10								
Factor acc. to CEN/TS 1992-4-5, Chapter 6.2.2.3	k_8		10,1								
Concrete cone failure											
Characteristic edge distance	$c_{cr,N}$	[mm]	$1,5 \cdot h_{ef}$								
Characteristic spacing	$s_{cr,N}$	[mm]	$2 \cdot c_{cr,N}$								
Factor acc. to CEN/TS 1992-4-5, Chapter 6.2.3.1	k_{ucr}		10,1								
Splitting failure											
Characteristic edge distance	$c_{cr,sp}$	[mm]	$1,0 \cdot h_{ef} \leq 2 \cdot h_{ef} \left(2,5 - \frac{h}{h_{ef}} \right) \leq 2,4 \cdot h_{ef}$								
Characteristic spacing	$s_{cr,sp}$	[mm]	$2 \cdot c_{cr,sp}$								
Installation safety factor (dry and wet concrete)	γ_{inst}		1,0	1,2							
Installation safety factor (flooded bore hole)	γ_{inst}		1,4					No Performance Determined (NPD)			

DEWALT AC100-PRO Injection resin with anchor rod for concrete

Annex C10

Performances

Application with threaded rod
Characteristic values for tension loads in uncracked concrete

CEN/TS1992-4

**Table C11: Design according to CEN/TS1992-4
Characteristic values for tension loads in cracked concrete**

Anchor size threaded rod			M 12	M 16	M 20	M24	M 27	M 30	
Steel failure									
Characteristic tension resistance	$N_{Rk,s}$	[kN]	See CEN/TS 1992-4-5, Chapter 6.2.2, $N_{Rk,s} = A_s \cdot f_{uk}$						
Stressed cross section	A_s	[mm ²]	84,3	156,7	244,8	352,5	459,4	560,6	
Combined pullout and concrete cone failure									
<i>Characteristic bond resistance in cracked concrete C20/25</i>									
dry and wet concrete	Temp. range I: 40°C/24°C	$\tau_{Rk,cr}$	[N/mm ²]	5,5	5,5	5,5	5,5	6,5	6,5
	Temp. range II: 80°C/50°C	$\tau_{Rk,cr}$	[N/mm ²]	4,0	4,0	4,0	4,0	4,5	4,5
	Temp. range III: 120°C/72°C	$\tau_{Rk,cr}$	[N/mm ²]	3,0	3,0	3,0	3,0	3,5	3,5
flooded bore hole	Temp. range I: 40°C/24°C	$\tau_{Rk,cr}$	[N/mm ²]	6,0	6,0	No Performance Determined (NPD)			
	Temp. range II: 80°C/50°C	$\tau_{Rk,cr}$	[N/mm ²]	4,5	4,5				
	Temp. range III: 120°C/72°C	$\tau_{Rk,cr}$	[N/mm ²]	3,5	3,5				
Increasing factors for cracked concrete ψ_c		C30/37		1,04					
		C40/50		1,08					
		C50/60		1,10					
Factor acc. to CEN/TS 1992-4-5, Chapter 6.2.2.3		k_B		7,2					
Concrete cone failure									
Characteristic edge distance	$c_{cr,N}$	[mm]	1,5 · h _{ef}						
Characteristic spacing	$s_{cr,N}$	[mm]	2 · c _{cr,N}						
Factor acc. to CEN/TS 1992-4-5, Chapter 6.2.3.1		k_{cr}	7,2						
Splitting failure									
Characteristic edge distance	$c_{cr,sp}$	[mm]	$1,0 \cdot h_{ef} \leq 2 \cdot h_{ef} \left(2,5 - \frac{h}{h_{ef}} \right) \leq 2,4 \cdot h_{ef}$						
Characteristic spacing	$s_{cr,sp}$	[mm]	2 · c _{cr,sp}						
Installation safety factor (dry and wet concrete)	γ_{inst}		1,2						
Installation safety factor (flooded bore hole)	γ_{inst}		1,8	No Performance Determined (NPD)					

DEWALT AC100-PRO Injection resin with anchor rod for concrete

Annex C11

Performances

Application with threaded rod
Design method A: Characteristic values for tension loads in cracked concrete

CEN/TS1992-4

**Table C12: Design according to CEN/TS1992-4
Characteristic values for shear loads in cracked and uncracked concrete**

Anchor size threaded rod			M 8	M 10	M 12	M 16	M 20	M 24	M 27	M 30
Steel failure without lever arm										
Characteristic tension resistance	$V_{Rk,s}$	[kN]	See CEN/TS 1992-4-5, Chapter 6.3.2.1, $V_{Rk,s}=0,5 \cdot A_s \cdot f_{uk}$							
Stressed cross section	A_s	[mm ²]	36,6	58,0	84,3	156,7	244,8	352,5	459,4	560,6
Steel failure with lever arm										
Characteristic bending resistance	$M^0_{Rk,s}$	[Nm]	See CEN/TS 1992-4-5, Chapter 6.3.2.2, $M^0_{Rk,s}=1,2 \cdot W_{el} \cdot f_{uk}$							
Elastic section modulus	W_{el}	[mm ³]	31,2	62,3	109,1	276,6	540,3	933,4	1389	1872
Ductility factor	k_2		0,80							
Concrete pryout failure										
Factor acc. to Eq. (27) CEN/TS 1992-4-5, Chapter 6.3.3	k_3		2,0							
Installation safety factor	γ_{inst}		1,0							
Concrete edge failure										
see CEN/TS 1992-4-5, Section 6.3.4										
Effective length of anchor	l_f	[mm]	$l_f = \min(h_{ef}, 8d_{nom})$							
Outside diameter of anchor	d_{nom}	[mm]	8	10	12	16	20	24	27	30
Installation safety factor	γ_{inst}		1,0							

DEWALT AC100-PRO Injection resin with anchor rod for concrete

Annex C12

Performances

Application with threaded rod
Characteristic values for shear loads in cracked and uncracked concrete

CEN/TS1992-4

Table C13: Design according to CEN/TS1992-4													
Characteristic values for tension loads in uncracked concrete													
Anchor size reinforcing bar				Ø 8	Ø 10	Ø 12	Ø 14	Ø 16	Ø 20	Ø 24	Ø 25	Ø 28	Ø 32
Steel failure													
Characteristic tension resistance		$N_{Rk,s}$	[kN]	See CEN/TS 1992-4-5, Chapter 6.2.2, $N_{Rk,s} = A_s \cdot f_{uk}$									
Stressed cross section		A_s	[mm ²]	50,3	78,5	113,1	153,9	201,1	314,2	452,4	490,9	615,8	804
Combined pullout and concrete cone failure													
<i>Characteristic bond resistance in uncracked concrete C20/25</i>													
dry and wet concrete	Temp. range I: 40°C/24°C	$\tau_{Rk,ucr}$	[N/mm ²]	11	13	13	13	13	13	11,5	11,5	10,5	9,0
	Temp. range II: 80°C/50°C	$\tau_{Rk,ucr}$	[N/mm ²]	8,0	9,5	9,5	9,5	9,5	9,5	8,5	8,5	7,5	6,5
	Temp. range III: 120°C/72°C	$\tau_{Rk,ucr}$	[N/mm ²]	5,5	6,5	6,5	6,5	6,5	6,5	6,0	6,0	5,0	4,5
flooded bore hole	Temp. range I: 40°C/24°C	$\tau_{Rk,ucr}$	[N/mm ²]	8,0	9,5	9,5	9,5	9,5	No Performance Determined (NPD)				
	Temp. range II: 80°C/50°C	$\tau_{Rk,ucr}$	[N/mm ²]	6,0	7,0	7,0	7,0	7,0					
	Temp. range III: 120°C/72°C	$\tau_{Rk,ucr}$	[N/mm ²]	4,5	5,5	5,5	5,5	5,5					
Increasing factors for non-cracked concrete ψ_c		C30/37							1,04				
		C40/50							1,08				
		C50/60							1,10				
Factor acc. to CEN/TS 1992-4-5, Chapter 6.2.2.3		k_8							10,1				
Concrete cone failure													
Characteristic edge distance		$C_{cr,N}$	[mm]						1,5 · h_{ef}				
Characteristic spacing		$S_{cr,N}$	[mm]						2 · $C_{cr,N}$				
Factor acc. to CEN/TS 1992-4-5, Chapter 6.2.3.1		k_{ucr}							10,1				
Splitting failure													
Characteristic edge distance		$C_{cr,sp}$	[mm]						$1,0 \cdot h_{ef} \leq 2 \cdot h_{ef} \left(2,5 - \frac{h}{h_{ef}} \right) \leq 2,4 \cdot h_{ef}$				
Characteristic spacing		$S_{cr,sp}$	[mm]						2 · $C_{cr,sp}$				
Installation safety factor (dry and wet concrete)		γ_{inst}		1,0						1,2			
Installation safety factor (flooded bore hole)		γ_{inst}		1,4					No Performance Determined (NPD)				
DEWALT AC100-PRO Injection resin with anchor rod for concrete										Annex C13			
Performances Application with reinforcing bar Characteristic values for tension loads in uncracked concrete													
CEN/TS1992-4													

**Table C14: Design according to CEN/TS1992-4
Characteristic values for tension loads in cracked concrete**

Anchor size reinforcing bar				Ø 12	Ø 14	Ø 16	Ø 20	Ø 24	Ø 25	Ø 28	Ø 32
Steel failure											
Characteristic tension resistance		$N_{Rk,s}$	[kN]	See CEN/TS 1992-4-5, Chapter 6.2.2, $N_{Rk,s} = A_s \cdot f_{uk}$							
Stressed cross section		A_s	[mm ²]	113,1	153,9	201	314,2	452,4	490,9	615,8	804
Combined pullout and concrete cone failure											
<i>Characteristic bond resistance in cracked concrete C20/25</i>											
dry and wet concrete	Temp. range I: 40°C/24°C	$\tau_{Rk,cr}$	[N/mm ²]	5,5	5,5	5,5	5,5	5,5	5,5	6,5	6,5
	Temp. range II: 80°C/50°C	$\tau_{Rk,cr}$	[N/mm ²]	4,0	4,0	4,0	4,0	4,0	4,0	4,5	4,5
	Temp. range III: 120°C/72°C	$\tau_{Rk,cr}$	[N/mm ²]	3,0	3,0	3,0	3,0	3,0	3,0	3,5	3,5
flooded bore hole	Temp. range I: 40°C/24°C	$\tau_{Rk,cr}$	[N/mm ²]	6,0	6,0	6,0	No Performance Determined (NPD)				
	Temp. range II: 80°C/50°C	$\tau_{Rk,cr}$	[N/mm ²]	4,5	4,5	4,5					
	Temp. range III: 120°C/72°C	$\tau_{Rk,cr}$	[N/mm ²]	3,5	3,5	3,5					
Increasing factors for cracked concrete ψ_c		C30/37		1,04							
		C40/50		1,08							
		C50/60		1,10							
Factor acc. to CEN/TS 1992-4-5, Chapter 6.2.2.3		k_8		7,2							
Concrete cone failure											
Characteristic edge distance		$C_{cr,N}$	[mm]	$1,5 \cdot h_{ef}$							
Characteristic spacing		$S_{cr,N}$	[mm]	$2 \cdot C_{cr,N}$							
Factor acc. to CEN/TS 1992-4-5, Chapter 6.2.3.1		k_{cr}		7,2							
Splitting failure											
Characteristic edge distance		$C_{cr,sp}$	[mm]	$1,0 \cdot h_{ef} \leq 2 \cdot h_{ef} \left(2,5 - \frac{h}{h_{ef}} \right) \leq 2,4 \cdot h_{ef}$							
Characteristic spacing		$S_{cr,sp}$	[mm]	$2 \cdot C_{cr,sp}$							
Installation safety factor (dry and wet concrete)		γ_{inst}		1,2							
Installation safety factor (flooded bore hole)		γ_{inst}		1,4				No Performance Determined (NPD)			

DEWALT AC100-PRO Injection resin with anchor rod for concrete

Annex C14

Performances

Application with reinforcing bar
Characteristic values for tension loads in cracked concrete

CEN/TS1992-4

**Table C15: Design according to CEN/TS1992-4
Characteristic values for shear loads in cracked and uncracked concrete**

Anchor size reinforcing bar		Ø 8	Ø 10	Ø 12	Ø 14	Ø 16	Ø 20	Ø 24	Ø 25	Ø 28	Ø 32	
Steel failure without lever arm												
Characteristic tension resistance	$V_{Rk,s}$	[kN]	See CEN/TS 1992-4-5, Chapter 6.3.2.1, $V_{Rk,s}=0,5 \cdot A_s \cdot f_{uk}$									
Stressed cross section	A_s	[mm ²]	50,3	78,5	113,1	153,9	201,1	314,2	452,4	490,9	615,8	804,2
Steel failure with lever arm												
Characteristic bending resistance	$M^0_{Rk,s}$	[Nm]	See CEN/TS 1992-4-5, Chapter 6.3.2.2, $M^0_{Rk,s}=1,2 \cdot W_{el} \cdot f_{uk}$									
Elastic section modulus	W_{el}	[mm ³]	50,3	98,2	169,6	269,4	402,1	785,4	1357	1534	2155	3217
Ductility factor	k_2		0,80									
Concrete pryout failure												
Factor acc. to Eq. (27) CEN/TS 1992-4-5, Chapter 6.3.3	k_3		2,0									
Installation safety factor	γ_{inst}		1,0									
Concrete edge failure												
see CEN/TS 1992-4-5, Section 6.3.4												
Effective length of anchor	l_f	[mm]	$l_f = \min(h_{ef}, 8d_{nom})$									
Outside diameter of anchor	d_{nom}	[mm]	8	10	12	14	16	20	24	25	28	32
Installation safety factor	γ_{inst}		1,0									

DEWALT AC100-PRO Injection resin with anchor rod for concrete

Annex C15

Performances

Application with reinforcing bar
Characteristic values for shear loads in cracked and uncracked concrete

CEN/TS1992-4

Table C16: Design according to CEN/TS1992-4
Characteristic values for tension loads in uncracked concrete

Anchor size internal threaded sleeve			M 8	M 10	M 12	M 16	M 20
External diameter			12	16	20	24	30
Effective anchorage depth h_{ef} [mm]			80	90	110	150	200
Steel failure (internal threaded sleeve)							
Char. tension resistance zinc plated		$N_{Rk,s}$ [kN]	19,5	42,8	71,1	83,7	135,7
Char. tension resistance, A4 steel		$N_{Rk,s}$ [kN]	24,2	53,1	88,1	103,8	135,7
Steel failure (threaded rod)							
Characteristic tension resistance		$N_{Rk,s}$ [kN]	See CEN/TS 1992-4-5, Chapter 6.2.2, $N_{Rk,s} = A_s \cdot f_{uk}$				
Stressed cross section		A_s [mm ²]	36,6	58,0	84,3	156,7	244,8
Combined pullout and concrete cone failure							
<i>Characteristic bond resistance in non-cracked concrete C20/25</i>							
dry and wet concrete	Temp. range I: 40°C/24°C	$\tau_{Rk,ucr}$ [N/mm ²]	13	13	13	12	9,5
	Temp. range II: 80°C/50°C	$\tau_{Rk,ucr}$ [N/mm ²]	9,5	9,5	9,5	9,0	7,0
	Temp. range III: 120°C/72°C	$\tau_{Rk,ucr}$ [N/mm ²]	6,5	6,5	6,5	6,0	5,0
flooded bore hole	Temp. range I: 40°C/24°C	$\tau_{Rk,ucr}$ [N/mm ²]	9,5	9,5	No Performance Determined (NPD)		
	Temp. range II: 80°C/50°C	$\tau_{Rk,ucr}$ [N/mm ²]	7,0	7,0			
	Temp. range III: 120°C/72°C	$\tau_{Rk,ucr}$ [N/mm ²]	5,5	5,5			
Increasing factors for non-cracked concrete ψ_c		C30/37	1,04				
		C40/50	1,08				
		C50/60	1,10				
Factor acc. to CEN/TS 1992-4-5, Chapter 6.2.2.3		k_8	10,1				
Concrete cone failure							
Characteristic edge distance		$C_{cr,N}$ [mm]	$1,5 \cdot h_{ef}$				
Characteristic spacing		$S_{cr,N}$ [mm]	$2 \cdot C_{cr,N}$				
Factor acc. to CEN/TS 1992-4-5, Chapter 6.2.3.1		k_{ucr}	10,1				
Splitting failure							
Characteristic edge distance		$C_{cr,sp}$ [mm]	$1,0 \cdot h_{ef} \leq 2 \cdot h_{ef} \left(2,5 - \frac{h}{h_{ef}} \right) \leq 2,4 \cdot h_{ef}$				
Characteristic spacing		$S_{cr,sp}$ [mm]	$2 \cdot C_{cr,sp}$				
Installation safety factor (dry and wet concrete)		γ_{inst}	1,2				
Installation safety factor (flooded bore hole)		γ_{inst}	1,4	No Performance Determined (NPD)			

DEWALT AC100-PRO Injection resin with anchor rod for concrete

Annex C16

Performances

Application with internal threaded sleeve
Characteristic values for tension loads in uncracked concrete

CEN/TS1992-4

**Table C17: Design according to CEN/TS1992-4
Characteristic values for tension loads in cracked concrete**

Anchor size internal threaded sleeve			M 8	M 10	M 12	M 16	M 20	
External diameter			12	16	20	24	30	
Effective anchorage depth h_{ef} [mm]			80	90	110	150	200	
Steel failure (internal threaded sleeve)								
Char. tension resistance Zinc plated		$N_{RK,s}$	[kN]	19,5	42,8	71,1	83,7	135,7
Char. tension resistance, A4 steel		$N_{RK,s}$	[kN]	24,2	53,1	88,1	103,8	135,7
Steel failure (threaded rod)								
Characteristic tension resistance		$N_{RK,s}$	[kN]	See CEN/TS 1992-4-5, Chapter 6.2.2, $N_{RK,s} = A_s \cdot f_{uk}$				
Stressed cross section		A_s	[mm ²]	36,6	58,0	84,3	156,7	244,8
Combined pullout and concrete cone failure								
<i>Characteristic bond resistance in cracked concrete C20/25</i>								
dry and wet concrete	Temp. range I: 40°C/24°C	$\tau_{RK,cr}$	[N/mm ²]	5,5	5,5	5,5	5,5	6,5
	Temp. range II: 80°C/50°C	$\tau_{RK,cr}$	[N/mm ²]	4,0	4,0	4,0	4,0	4,5
	Temp. range III: 120°C/72°C	$\tau_{RK,cr}$	[N/mm ²]	3,0	3,0	3,0	3,0	3,5
flooded bore hole	Temp. range I: 40°C/24°C	$\tau_{RK,cr}$	[N/mm ²]	6,0	6,0	No Performance Determined (NPD)		
	Temp. range II: 80°C/50°C	$\tau_{RK,cr}$	[N/mm ²]	4,5	4,5			
	Temp. range III: 120°C/72°C	$\tau_{RK,cr}$	[N/mm ²]	3,5	3,5			
Increasing factors for cracked concrete ψ_c		C30/37		1,04				
		C40/50		1,08				
		C50/60		1,10				
Factor acc. to CEN/TS 1992-4-5, Chapter 6.2.2.3		k_8		7,2				
Concrete cone failure								
Characteristic edge distance		$c_{cr,N}$	[mm]	$1,5 \cdot h_{ef}$				
Characteristic spacing		$s_{cr,N}$	[mm]	$2 \cdot c_{cr,N}$				
Factor acc. to CEN/TS 1992-4-5, Chapter 6.2.3.1		k_{cr}		7,2				
Splitting failure								
Characteristic edge distance		$c_{cr,sp}$	[mm]	$1,0 \cdot h_{ef} \leq 2 \cdot h_{ef} \left(2,5 - \frac{h}{h_{ef}} \right) \leq 2,4 \cdot h_{ef}$				
Characteristic spacing		$s_{cr,sp}$	[mm]	$2 \cdot c_{cr,sp}$				
Installation safety factor (dry and wet concrete)		γ_{inst}		1,2				
Installation safety factor (flooded bore hole)		γ_{inst}		1,4	No Performance Determined (NPD)			

DEWALT AC100-PRO Injection resin with anchor rod for concrete

Annex C17

Performances
Application with internal threaded sleeve
Characteristic values for tension loads in cracked concrete

CEN/TS1992-4

Table C18: Design according to CEN/TS1992-4
Characteristic values for shear loads in cracked and uncracked concrete

Anchor size internal threaded sleeve		M 8	M 10	M 12	M 16	M 20
External diameter		12	16	20	24	30
Effective anchorage depth h_{cf} [mm]		80	90	110	150	200
Steel failure without lever arm (internal threaded sleeve)						
Characteristic shear resistance, Zinc plated	$V_{Rk,s}$ [kN]	9,7	21,4	35,5	41,9	67,9
Characteristic shear resistance, A4 steel	$V_{Rk,s}$ [kN]	12,1	26,5	44,1	51,9	67,9
Steel failure without lever arm (threaded rod)						
Characteristic tension resistance	$V_{Rk,s}$ [kN]	See CEN/TS 1992-4-5, Chapter 6.3.2.1, $V_{Rk,s}=0,5 \cdot A_s \cdot f_{uk}$				
Stressed cross section	A_s [mm ²]	36,6	58,0	84,3	156,7	244,8
Steel failure with lever arm (internal threaded sleeve)						
Characteristic bending moment, Zinc plated	$M^0_{Rk,s}$ [Nm]	46,5	131,8	267,2	405,7	824,5
Characteristic bending moment, A4 steel	$M^0_{Rk,s}$ [Nm]	57,7	163,4	331,3	503,0	824,5
Ductility factor	k_2	0,8				
Steel failure with lever arm (threaded rod)						
Characteristic bending resistance	$M^0_{Rk,s}$ [Nm]	See CEN/TS 1992-4-5, Chapter 6.3.2.2, $M^0_{Rk,s}=1,2 \cdot W_{el} \cdot f_{uk}$				
Elastic section modulus	W_{el} [mm ³]	31,2	62,3	109,1	276,6	540,3
Ductility factor	k_2	0,8				
Concrete pryout failure						
Factor acc. to Eq. (27) CEN/TS 1992-4-5, Chapter 6.3.3	k_3	2,0				
Installation safety factor	γ_{inst}	1,00				
Concrete edge failure						
See CEN/TS 1992-4-5, Chapter 6.3.4						
Effective length of anchor	l_f [mm]	$l_f = \min(h_{ef}, 8d_{nom})$				
Outside diameter of anchor	d_{nom} [mm]	12	16	20	24	30
Installation safety factor	γ_{inst}	1,0				

DEWALT AC100-PRO Injection resin with anchor rod for concrete

Annex C18

Performances

Application with internal threaded sleeve

Characteristic values for shear loads in cracked and uncracked concrete

CEN/TS1992-4

Table C19: Displacements for tension loads¹⁾ (threaded rod)

Anchor size threaded rod			M 8	M 10	M 12	M 16	M 20	M24	M 27	M 30
Uncracked concrete										
Temperature range I 40°C/24°C										
Displacement	δ_{N0} - factor	[mm/ (N/mm ²)]	0,021	0,023	0,026	0,031	0,036	0,041	0,045	0,049
Displacement	$\delta_{N\infty}$ - factor	[mm/ (N/mm ²)]	0,034	0,033	0,037	0,045	0,052	0,060	0,065	0,071
Temperature range II 80°C/50°C										
Displacement	δ_{N0} - factor	[mm/ (N/mm ²)]	0,050	0,056	0,063	0,075	0,088	0,100	0,110	0,119
Displacement	$\delta_{N\infty}$ - factor	[mm/ (N/mm ²)]	0,072	0,081	0,090	0,108	0,127	0,145	0,159	0,172
Temperature range III 120°C/72°C										
Displacement	δ_{N0} - factor	[mm/ (N/mm ²)]	0,050	0,056	0,063	0,075	0,088	0,100	0,110	0,119
Displacement	$\delta_{N\infty}$ - factor	[mm/ (N/mm ²)]	0,072	0,081	0,090	0,108	0,127	0,145	0,159	0,172
Cracked concrete										
Temperature range I 40°C/24°C										
Displacement	δ_{N0} - factor	[mm/ (N/mm ²)]	-	-	0,07	0,07	0,07	0,07	0,07	0,07
Displacement	$\delta_{N\infty}$ - factor	[mm/ (N/mm ²)]	-	-	0,105	0,105	0,105	0,105	0,105	0,105
Temperature range II 80°C/50°C										
Displacement	δ_{N0} - factor	[mm/ (N/mm ²)]	-	-	0,17	0,17	0,17	0,17	0,17	0,17
Displacement	$\delta_{N\infty}$ - factor	[mm/ (N/mm ²)]	-	-	0,245	0,245	0,245	0,245	0,245	0,245
Temperature range III 120°C/72°C										
Displacement	δ_{N0} - factor	[mm/ (N/mm ²)]	-	-	0,17	0,17	0,17	0,17	0,17	0,17
Displacement	$\delta_{N\infty}$ - factor	[mm/ (N/mm ²)]	-	-	0,245	0,245	0,245	0,245	0,245	0,245

¹⁾ Calculation of the displacement

$$\delta_{N0} = \delta_{N0} - \text{factor} \cdot \tau$$

$$\delta_{N\infty} = \delta_{N\infty} - \text{factor} \cdot \tau$$

Table C20: Displacement for shear load¹⁾ (threaded rod)

Anchor size threaded rod			M 8	M 10	M 12	M 16	M 20	M24	M 27	M 30
Uncracked concrete										
Displacement	δ_{V0} - factor	[mm/ kN]	0,06	0,06	0,05	0,04	0,04	0,03	0,03	0,03
Displacement	$\delta_{V\infty}$ - factor	[mm/ kN]	0,09	0,08	0,08	0,06	0,06	0,05	0,05	0,04
Cracked concrete										
Displacement	δ_{V0} - factor	[mm/ kN]	-	-	0,112	0,103	0,093	0,084	0,076	0,069
Displacement	$\delta_{V\infty}$ - factor	[mm/ kN]	-	-	0,169	0,154	0,140	0,125	0,115	0,104

¹⁾ Calculation of the displacement

$$\delta_{V0} = \delta_{V0} - \text{factor} \cdot \tau$$

$$\delta_{V\infty} = \delta_{V\infty} - \text{factor} \cdot \tau$$

DEWALT AC100-PRO Injection resin with anchor rod for concrete

Annex C19

Performances
Displacements
(Threaded rod)

Table C21: Displacements for tension loads¹⁾ (reinforcing bar)

Anchor size reinforcing bar			Ø 8	Ø 10	Ø 12	Ø 14	Ø 16	Ø 20	Ø 24	Ø 25	Ø 28	Ø 32
Uncracked concrete												
Temperature range I 40°C/24°C												
Displacement	δ_{N0} - factor	[mm/(N/mm ²)]	0,021	0,023	0,026	0,028	0,031	0,036	0,042	0,043	0,047	0,052
Displacement	$\delta_{N\infty}$ - factor	[mm/(N/mm ²)]	0,034	0,033	0,037	0,041	0,045	0,052	0,057	0,061	0,071	0,075
Temperature range II 80°C/50°C												
Displacement	δ_{N0} - factor	[mm/(N/mm ²)]	0,050	0,056	0,063	0,069	0,075	0,088	0,103	0,104	0,113	0,126
Displacement	$\delta_{N\infty}$ - factor	[mm/(N/mm ²)]	0,072	0,081	0,090	0,099	0,108	0,127	0,144	0,149	0,163	0,181
Temperature range III 120°C/72°C												
Displacement	δ_{N0} - factor	[mm/(N/mm ²)]	0,050	0,056	0,063	0,069	0,075	0,088	0,103	0,104	0,113	0,126
Displacement	$\delta_{N\infty}$ - factor	[mm/(N/mm ²)]	0,072	0,081	0,090	0,099	0,108	0,127	0,144	0,149	0,163	0,181
Cracked concrete												
Temperature range I 40°C/24°C												
Displacement	δ_{N0} - factor	[mm/(N/mm ²)]	-	-	0,07	0,07	0,07	0,07	0,07	0,07	0,07	0,07
Displacement	$\delta_{N\infty}$ - factor	[mm/(N/mm ²)]	-	-	0,105	0,105	0,105	0,105	0,105	0,105	0,105	0,105
Temperature range II 80°C/50°C												
Displacement	δ_{N0} - factor	[mm/(N/mm ²)]	-	-	0,17	0,17	0,17	0,17	0,17	0,17	0,17	0,17
Displacement	$\delta_{N\infty}$ - factor	[mm/(N/mm ²)]	-	-	0,245	0,245	0,245	0,245	0,245	0,245	0,245	0,245
Temperature range III 120°C/72°C												
Displacement	δ_{N0} - factor	[mm/(N/mm ²)]	-	-	0,17	0,17	0,17	0,17	0,17	0,17	0,17	0,17
Displacement	$\delta_{N\infty}$ - factor	[mm/(N/mm ²)]	-	-	0,245	0,245	0,245	0,245	0,245	0,245	0,245	0,245

¹⁾ Calculation of the displacement

$$\delta_{N0} = \delta_{N0} - \text{factor} \cdot \tau$$

$$\delta_{N\infty} = \delta_{N\infty} - \text{factor} \cdot \tau$$

Table C22: Displacement for shear load¹⁾ (reinforcing bar)

Anchor size reinforcing bar			Ø 8	Ø 10	Ø 12	Ø 14	Ø 16	Ø 20	Ø 24	Ø 25	Ø 28	Ø 32
Uncracked concrete												
Displacement	δ_{V0} - factor	[mm/(kN)]	0,06	0,05	0,05	0,04	0,04	0,04	0,04	0,03	0,03	0,03
Displacement	$\delta_{V\infty}$ - factor	[mm/(kN)]	0,09	0,08	0,08	0,06	0,06	0,05	0,05	0,05	0,04	0,04
Cracked concrete												
Displacement	δ_{V0} - factor	[mm/(kN)]	-	-	0,112	0,108	0,103	0,093	0,083	0,081	0,074	0,064
Displacement	$\delta_{V\infty}$ - factor	[mm/(kN)]	-	-	0,169	0,161	0,154	0,140	0,126	0,122	0,111	0,097

¹⁾ Calculation of the displacement

$$\delta_{V0} = \delta_{V0} - \text{factor} \cdot \tau$$

$$\delta_{V\infty} = \delta_{V\infty} - \text{factor} \cdot \tau$$

DEWALT AC100-PRO Injection resin with anchor rod for concrete

Annex C20

Performances
Displacements
(Reinforcing bar)

Table C23: Displacements for tension loads¹⁾ (internal threaded sleeve)

Anchor size internal threaded sleeve			M 8	M 10	M 12	M 16	M 20
External diameter			12	16	20	24	30
Effective anchorage depth h_{ef} [mm]			80	90	110	150	200
Uncracked concrete							
Temperature range I 40°C/24°C							
Displacement	δ_{N0} - factor	[mm/ (N/mm ²)]	0,026	0,031	0,036	0,041	0,049
Displacement	$\delta_{N\infty}$ - factor	[mm/ (N/mm ²)]	0,034	0,045	0,052	0,060	0,071
Temperature range II 80°C/50°C							
Displacement	δ_{N0} - factor	[mm/ (N/mm ²)]	0,063	0,075	0,088	0,100	0,119
Displacement	$\delta_{N\infty}$ - factor	[mm/ (N/mm ²)]	0,090	0,108	0,127	0,145	0,172
Temperature range III 120°C/72°C							
Displacement	δ_{N0} - factor	[mm/ (N/mm ²)]	0,063	0,075	0,088	0,100	0,119
Displacement	$\delta_{N\infty}$ - factor	[mm/ (N/mm ²)]	0,090	0,108	0,127	0,145	0,172
Cracked concrete							
Temperature range I 40°C/24°C							
Displacement	δ_{N0} - factor	[mm/ (N/mm ²)]	0,07	0,07	0,07	0,07	0,07
Displacement	$\delta_{N\infty}$ - factor	[mm/ (N/mm ²)]	0,105	0,105	0,105	0,105	0,105
Temperature range II 80°C/50°C							
Displacement	δ_{N0} - factor	[mm/ (N/mm ²)]	0,17	0,17	0,17	0,17	0,17
Displacement	$\delta_{N\infty}$ - factor	[mm/ (N/mm ²)]	0,245	0,245	0,245	0,245	0,245
Temperature range III 120°C/72°C							
Displacement	δ_{N0} - factor	[mm/ (N/mm ²)]	0,17	0,17	0,17	0,17	0,17
Displacement	$\delta_{N\infty}$ - factor	[mm/ (N/mm ²)]	0,245	0,245	0,245	0,245	0,245

¹⁾ Calculation of the displacement

$$\delta_{N0} = \delta_{N0} \text{- factor} \cdot \tau$$

$$\delta_{N\infty} = \delta_{N\infty} \text{- factor} \cdot \tau$$

Table C24: Displacement for shear load¹⁾ (internal threaded sleeve)

Anchor size internal threaded sleeve			M 8	M 10	M 12	M 16	M 20
External diameter			12	16	20	24	30
Effective anchorage depth h_{ef} [mm]			80	90	110	150	200
Uncracked concrete							
Displacement	δ_{V0} - factor	[mm/ kN]	0,05	0,04	0,04	0,03	0,03
Displacement	$\delta_{V\infty}$ - factor	[mm/ kN]	0,08	0,06	0,06	0,05	0,04
Cracked concrete							
Displacement	δ_{V0} - factor	[mm/ kN]	0,112	0,103	0,093	0,084	0,069
Displacement	$\delta_{V\infty}$ - factor	[mm/ kN]	0,169	0,154	0,140	0,125	0,104

¹⁾ Calculation of the displacement

$$\delta_{V0} = \delta_{V0} \text{- factor} \cdot \tau$$

$$\delta_{V\infty} = \delta_{V\infty} \text{- factor} \cdot \tau$$

DEWALT AC100-PRO Injection resin with anchor rod for concrete

Annex C21

Performances
Displacements
(Internal threaded sleeve)

Table C25: Characteristic values of resistance for seismic design category C1 for threaded rods under tension load

Anchor size threaded rod			M12	M16	M20	M24	M27	M30
Steel failure								
Characteristic tension resistance, Steel, property class 4.6		$N_{Rk,s,seis}$ [kN]	34	63	98	141	184	224
Characteristic tension resistance, Steel, property class 5.8		$N_{Rk,s,seis}$ [kN]	42	78	122	176	230	280
Characteristic tension resistance, Steel, property class 8.8		$N_{Rk,s,seis}$ [kN]	67	125	196	282	368	449
Characteristic tension resistance, Stainless steel A4 and HCR, property class 50 (>M24) and 70 (≤M24)		$N_{Rk,s,seis}$ [kN]	59	110	171	247	230	281
Combined pull-out and concrete failure								
Characteristic bond resistance $\tau_{Rk,seis}^0$ [N/mm ²] in cracked concrete C20/25								
dry and wet concrete	Temp. range I: 40°C/24°C	$\tau_{Rk,cr}$ [N/mm ²]	3,7	3,7	3,7	3,8	4,5	4,5
	Temp. range II: 80°C/50°C	$\tau_{Rk,cr}$ [N/mm ²]	2,7	2,7	2,7	2,8	3,1	3,1
	Temp. range III: 120°C/72°C	$\tau_{Rk,cr}$ [N/mm ²]	2,0	2,0	2,0	2,1	2,4	2,4
flooded bore hole	Temp. range I: 40°C/24°C	$\tau_{Rk,cr}$ [N/mm ²]	3,7	3,7	No Performance Determined (NPD)			
	Temp. range II: 80°C/50°C	$\tau_{Rk,cr}$ [N/mm ²]	2,7	2,7				
	Temp. range III: 120°C/72°C	$\tau_{Rk,cr}$ [N/mm ²]	2,0	2,0				
Installation safety factor (dry and wet concrete)		$\gamma_2 = \gamma_{inst}$ [-]	1,2					
Installation safety factor (flooded bore hole)		$\gamma_2 = \gamma_{inst}$ [-]	1,4		No Performance Determined (NPD)			

Table C26: Displacements under tension load¹⁾ for seismic design category C1 for threaded rods

Anchor size threaded rod			M 12	M 16	M 20	M24	M 27	M 30
Cracked concrete								
Temperature range I 40°C/24°C								
Displacement	δ_{N0} - factor	[mm/ (N/mm ²)]	0,07	0,07	0,07	0,07	0,07	0,07
Displacement	$\delta_{N\infty}$ - factor	[mm/ (N/mm ²)]	0,105	0,105	0,105	0,105	0,105	0,105
Temperature range II 80°C/50°C								
Displacement	δ_{N0} - factor	[mm/ (N/mm ²)]	0,17	0,17	0,17	0,17	0,17	0,17
Displacement	$\delta_{N\infty}$ - factor	[mm/ (N/mm ²)]	0,245	0,245	0,245	0,245	0,245	0,245
Temperature range III 120°C/72°C								
Displacement	δ_{N0} - factor	[mm/ (N/mm ²)]	0,17	0,17	0,17	0,17	0,17	0,17
Displacement	$\delta_{N\infty}$ - factor	[mm/ (N/mm ²)]	0,245	0,245	0,245	0,245	0,245	0,245

¹⁾ Calculation of the displacement

$$\delta_{N0} = \delta_{N0} - \text{factor} \cdot \tau$$

$$\delta_{N\infty} = \delta_{N\infty} - \text{factor} \cdot \tau$$

DEWALT AC100-PRO Injection resin with anchor rod for concrete

Annex C22

Performances

Characteristic values of resistance and displacements for seismic design category C1 for threaded rods under tension loads

Table C27: Characteristic values of resistance for seismic design category C1 for threaded rods under shear load

Anchor size threaded rod			M12	M16	M20	M24	M27	M30
Steel failure without lever arm								
Characteristic tension resistance, Steel, property class 4.6	$V_{Rk,s,seis}$	[kN]	14	27	42	56	72	88
Characteristic tension resistance, Steel, property class 5.8	$V_{Rk,s,seis}$	[kN]	18	34	53	70	91	111
Characteristic tension resistance, Steel, property class 8.8	$V_{Rk,s,seis}$	[kN]	30	55	85	111	145	177
Characteristic tension resistance, Stainless steel A4 and HCR, property class 50 (>M24) and 70 (\leq M24)	$V_{Rk,s,seis}$	[kN]	26	48	75	98	91	111
Steel failure with lever arm								
Characteristic bending moment, Steel, property class 4.6	$M_{Rk,s,seis}^0$	[Nm]	No Performance Determined (NPD)					
Characteristic bending moment, Steel, property class 5.8	$M_{Rk,s,seis}^0$	[Nm]	No Performance Determined (NPD)					
Characteristic bending moment, Steel, property class 8.8	$M_{Rk,s,seis}^0$	[Nm]	No Performance Determined (NPD)					
Characteristic bending moment, Stainless steel A4 and HCR, property class 50 (>M24) and 70 (\leq M24)	$M_{Rk,s,seis}^0$	[Nm]	No Performance Determined (NPD)					
Installation safety factor	$\gamma_2 = \gamma_{inst}$	[-]	1,0					

Table C28: Displacements under shear load¹⁾ for seismic design category C1 for threaded rods

Anchor size threaded rod			M 12	M 16	M 20	M 24	M 27	M 30
Cracked concrete								
Displacement	δ_{V0} - factor	[mm/ kN]	0,112	0,103	0,093	0,084	0,076	0,069
Displacement	$\delta_{V\infty}$ - factor	[mm/ kN]	0,169	0,154	0,140	0,125	0,115	0,104

¹⁾ Calculation of the displacement

$$\delta_{V0} = \delta_{V0} - \text{factor} \cdot \tau$$

$$\delta_{V\infty} = \delta_{V\infty} - \text{factor} \cdot \tau$$

DEWALT AC100-PRO Injection resin with anchor rod for concrete

Annex C23

Performances

Characteristic values of resistance and displacements for seismic design category C1 for threaded rods under shear loads

Table C29: Characteristic values of resistance for seismic design category C1 for reinforcing bars under tension load

Anchor size reinforcing bar			Ø12	Ø14	Ø16	Ø20	Ø24	Ø25	Ø28	Ø32	
Steel failure											
Characteristic tension resistance	$N_{Rk,s,seis}$	[kN]	62	85	111	173	249	270	339	442	
Combined pull-out and concrete failure											
Characteristic bond resistance $\tau_{Rk,seis}^0$ [N/mm ²] in cracked concrete C20/25											
dry and wet concrete	Temp. range I: 40°C/24°C	$\tau_{Rk,cr}$	[N/mm ²]	3,7	3,7	3,7	3,7	3,7	3,8	4,5	4,5
	Temp. range II: 80°C/50°C	$\tau_{Rk,cr}$	[N/mm ²]	2,7	2,7	2,7	2,7	2,7	2,8	3,1	3,1
	Temp. range III: 120°C/72°C	$\tau_{Rk,cr}$	[N/mm ²]	2,0	2,0	2,0	2,0	2,0	2,1	2,4	2,4
flooded bore hole	Temp. range I: 40°C/24°C	$\tau_{Rk,cr}$	[N/mm ²]	3,7	3,7	3,7	No Performance Determined (NPD)				
	Temp. range II: 80°C/50°C	$\tau_{Rk,cr}$	[N/mm ²]	2,7	2,7	2,7					
	Temp. range III: 120°C/72°C	$\tau_{Rk,cr}$	[N/mm ²]	2,0	2,0	2,0					
Installation safety factor (dry and wet concrete)	$\gamma_2 = \gamma_{inst}$	[-]	1,2								
Installation safety factor (flooded bore hole)	$\gamma_2 = \gamma_{inst}$	[-]	1,4				No Performance Determined (NPD)				

Table C30: Displacements under tension load¹⁾ for seismic design category C1 for reinforcing bars

Anchor size reinforcing bar			Ø 12	Ø 14	Ø 16	Ø 20	Ø 24	Ø 25	Ø 28	Ø 32
Cracked concrete										
Temperature range I 40°C/24°C										
Displacement	δ_{N0} - factor	[mm/(N/mm ²)]	0,07	0,07	0,07	0,07	0,07	0,07	0,07	0,07
Displacement	$\delta_{N\infty}$ - factor	[mm/(N/mm ²)]	0,105	0,105	0,105	0,105	0,105	0,105	0,105	0,105
Temperature range II 80°C/50°C										
Displacement	δ_{N0} - factor	[mm/(N/mm ²)]	0,17	0,17	0,17	0,17	0,17	0,17	0,17	0,17
Displacement	$\delta_{N\infty}$ - factor	[mm/(N/mm ²)]	0,245	0,245	0,245	0,245	0,245	0,245	0,245	0,245
Temperature range III 120°C/72°C										
Displacement	δ_{N0} - factor	[mm/(N/mm ²)]	0,17	0,17	0,17	0,17	0,17	0,17	0,17	0,17
Displacement	$\delta_{N\infty}$ - factor	[mm/(N/mm ²)]	0,245	0,245	0,245	0,245	0,245	0,245	0,245	0,245

¹⁾ Calculation of the displacement

$$\delta_{N0} = \delta_{N0} \text{ - factor} \cdot \tau$$

$$\delta_{N\infty} = \delta_{N\infty} \text{ - factor} \cdot \tau$$

DEWALT AC100-PRO Injection resin with anchor rod for concrete

Annex C24

Performances

Characteristic values of resistance and displacements for seismic design category C1 for reinforcing bar under tension loads

Table C31: Characteristic values of resistance for seismic design category C1 for reinforcing bars under shear load

Anchor size reinforcing bar			Ø12	Ø14	Ø16	Ø20	Ø24	Ø25	Ø28	Ø32
Steel failure without lever arm										
Characteristic tension resistance	$V_{Rk,s,seis}$	[kN]	27,3	37,0	48,4	75,7	109	118	148	194
Steel failure with lever arm										
Characteristic bending moment	$M_{Rk,s,seis}^0$	[Nm]	No Performance Determined (NPD)							
Installation safety factor	$\gamma_2 = \gamma_{inst}$	[-]	1,0							

Table C32: Displacements under shear load¹⁾ for seismic design category C1 for reinforcing bars

Anchor size reinforcing bar			Ø 12	Ø 14	Ø 16	Ø 20	Ø 24	Ø 25	Ø 28	Ø 32
Cracked concrete										
Displacement	δ_{V0} - factor	[mm/(kN)]	0,112	0,108	0,103	0,093	0,083	0,081	0,074	0,064
Displacement	$\delta_{V\infty}$ - factor	[mm/(kN)]	0,169	0,161	0,154	0,140	0,126	0,122	0,111	0,097

¹⁾ Calculation of the displacement

$$\delta_{V0} = \delta_{V0} \text{ - factor} \cdot \tau$$

$$\delta_{V\infty} = \delta_{V\infty} \text{ - factor} \cdot \tau$$

DEWALT AC100-PRO Injection resin with anchor rod for concrete

Annex C25

Performances

Characteristic values of resistance and displacements for seismic design category C1 for reinforcing bar under shear loads