

Approval body for construction products  
and types of construction

Bautechnisches Prüfamt

An institution established by the Federal and  
Laender Governments



## European Technical Assessment

**ETA-15/0094**  
**of 4 March 2015**

English translation prepared by DIBt - Original version in German language

### General Part

Technical Assessment Body issuing the  
European Technical Assessment:

Deutsches Institut für Bautechnik

Trade name of the construction product

Interfixings injection system Easy-FIX for concrete

Product family  
to which the construction product belongs

Bonded Anchor with Anchor rod for use in concrete

Manufacturer

Interfixings NV - Easy-Fix  
Bergensesteenweg 454  
1600 ST. PIETERS LEEUW  
BELGIEN

Manufacturing plant

Interfixings Plant 2

This European Technical Assessment  
contains

27 pages including 3 annexes which form an integral part  
of this assessment

This European Technical Assessment is  
issued in accordance with Regulation (EU)  
No 305/2011, on the basis of

Guideline for European technical approval of "Metal  
anchors for use in concrete", ETAG 001 Part 5: "Bonded  
anchors", April 2013,  
used as European Assessment Document (EAD)  
according to Article 66 Paragraph 3 of Regulation (EU)  
No 305/2011.

**European Technical Assessment**  
**ETA-15/0094**

Page 2 of 27 | 4 March 2015

English translation prepared by DIBt

The European Technical Assessment is issued by the Technical Assessment Body in its official language. Translations of this European Technical Assessment in other languages shall fully correspond to the original issued document and shall be identified as such.

Communication of this European Technical Assessment, including transmission by electronic means, shall be in full. However, partial reproduction may only be made with the written consent of the issuing Technical Assessment Body. Any partial reproduction has to be identified as such.

This European Technical Assessment may be withdrawn by the issuing Technical Assessment Body, in particular pursuant to information by the Commission according to Article 25 Paragraph 3 of Regulation (EU) No 305/2011.

## Specific Part

### 1 Technical description of the product

The "Interfixings injection system Easy-FIX for concrete" is a bonded anchor consisting of a cartridge with injection mortar Easy-FIX and a steel element. The steel element consist of a commercial threaded rod with washer and hexagon nut in the range of M8 to M30 or a reinforcing bar in the range of diameter 8 to 32 mm.

The steel element is placed into a drilled hole filled with injection mortar and is anchored via the bond between metal part, injection mortar and concrete.

The product description is given in Annex A.

### 2 Specification of the intended use in accordance with the applicable European Assessment Document

The performances given in Section 3 are only valid if the anchor is used in compliance with the specifications and conditions given in Annex B.

The verifications and assessment methods on which this European Technical Assessment is based lead to the assumption of a working life of the anchor of at least 50 years. The indications given on the working life cannot be interpreted as a guarantee given by the producer, but are to be regarded only as a means for choosing the right products in relation to the expected economically reasonable working life of the works.

### 3 Performance of the product and references to the methods used for its assessment

#### 3.1 Mechanical resistance and stability (BWR 1)

Essential characteristic	Performance
Characteristic resistance for design according to TR 029 and TR 045	See Annex C 1 to C 6
Characteristic resistance for design according to CEN/TS 1992-4:2009 and TR 045	See Annex C 7 to C 12
Displacements under tension and shear loads	See Annex C 13 / C 14

#### 3.2 Safety in case of fire (BWR 2)

Essential characteristic	Performance
Reaction to fire	Anchorage satisfy requirements for Class A1
Resistance to fire	No performance determined (NPD)

#### 3.3 Hygiene, health and the environment (BWR 3)

Not applicable.

#### 3.4 Safety in use (BWR 4)

The essential characteristics regarding Safety in use are included under the Basic Works Requirement Mechanical resistance and stability.

#### 3.5 Protection against noise (BWR 5)

Not applicable.

English translation prepared by DIBt

**3.6 Energy economy and heat retention (BWR 6)**

Not applicable.

**3.7 Sustainable use of natural resources (BWR 7)**

The sustainable use of natural resources was not investigated.

**3.8 General aspects**

The verification of durability is part of testing the essential characteristics. Durability is only ensured if the specifications of intended use according to Annex B are taken into account.

**4 Assessment and verification of constancy of performance (AVCP) system applied, with reference to its legal base**

According to Decision of the Commission of 24 June 1996 (96/582/EC) (OJ L 254 of 08.10.96 p. 62-65), the system of assessment and verification of constancy of performance (see Annex V and Article 65 Paragraph 2 to Regulation (EU) No 305/2011) given in the following table applies.

Product	Intended use	Level or class	System
Metal anchors for use in concrete (heavy-duty type)	For fixing and/or supporting concrete structural elements or heavy units such as cladding and suspended ceilings	—	1

**5 Technical details necessary for the implementation of the AVCP system, as provided for in the applicable European Assessment Document**

Technical details necessary for the implementation of the AVCP system are laid down in the control plan deposited at Deutsches Institut für Bautechnik.

Issued in Berlin on 03 March 2015 by Deutsches Institut für Bautechnik

Uwe Bender  
Head of Department

*beglaubigt:*  
Baderschneider

### Installation threaded rod

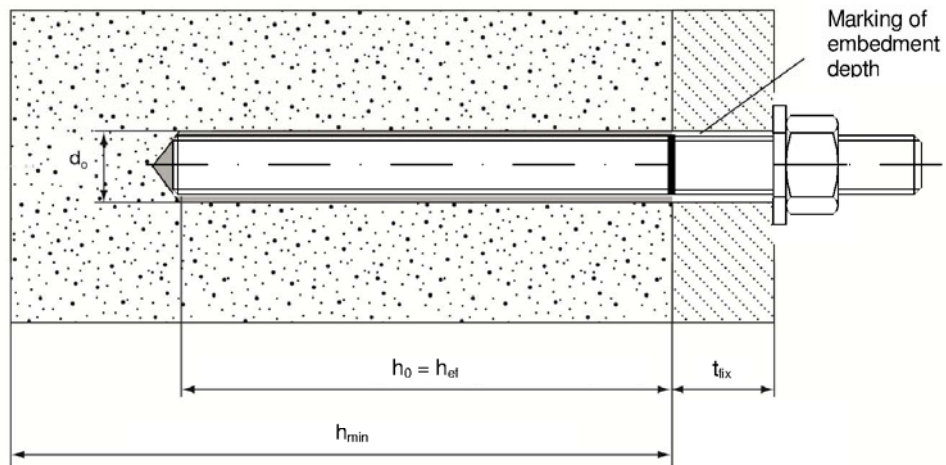

### Installation reinforcing bar

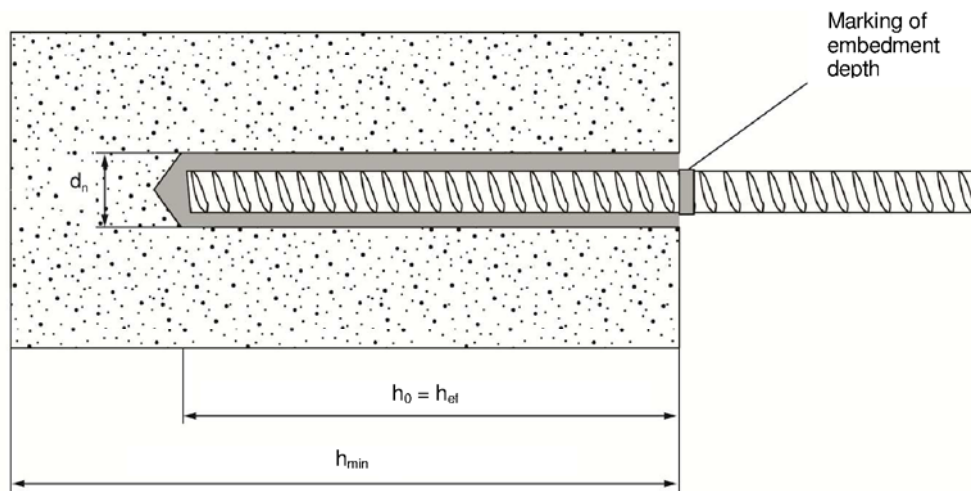

- $d_f$  = diameter of clearance hole in the fixture
- $t_{fix}$  = thickness of fixture
- $h_{ef}$  = effective anchorage depth
- $h_0$  = depth of drill hole
- $h_{min}$  = minimum thickness of member

### Interfixings Injection system Easy-FIX for concrete

Product description  
Installed condition

Annex A1

### Injection mortar: Easy-FIX

150 ml, 280 ml, 300 ml to 330 ml, 380 ml to 420 ml cartridge (Type: coaxial)



235 ml, 345 ml and 825 ml cartridge (Type: "side-by-side")

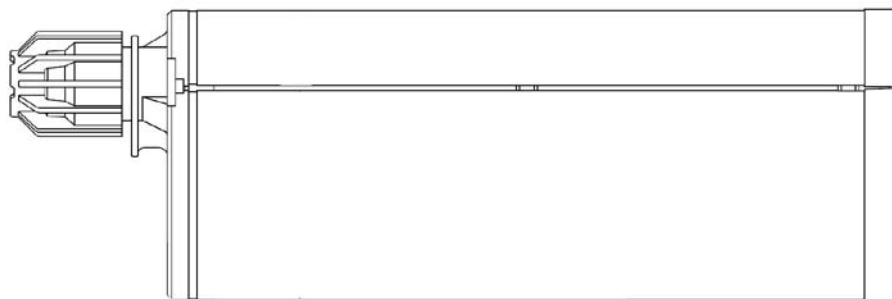

165 ml and 300 ml cartridge (Type: "foil tube")



Cartridge label: Easy-FIX, processing notes, charge-code, shelf life, hazard-code, curing- and processing time (depending on the temperature), with as well as without travel scale

### Static mixer

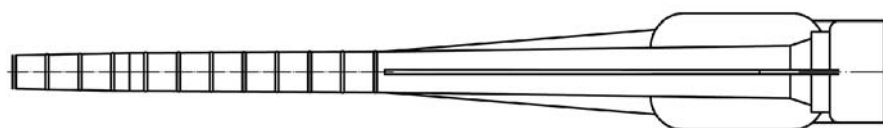

### Interfixings Injection system Easy-FIX for concrete

Product description  
Injection system

Annex A2

**Threaded rod M8, M10, M12, M16, M20, M24, M27, M30 with washer and hexagon nut**

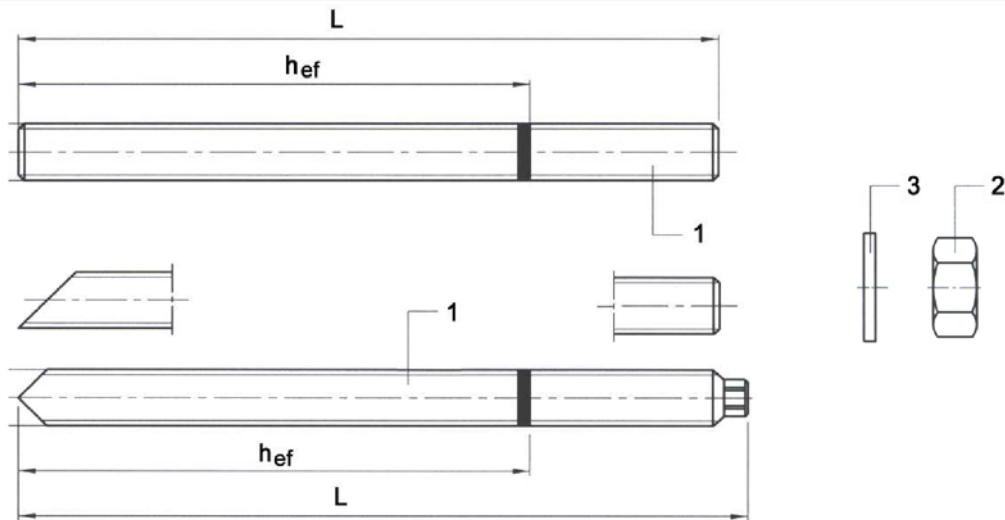

Commercial standard rod with:

- Materials, dimensions and mechanical properties acc. Table A1
- Inspection certificate 3.1 acc. to EN 10204:2004
- Marking of embedment depth

**Reinforcing bar  $\varnothing 8, \varnothing 10, \varnothing 12, \varnothing 14, \varnothing 16, \varnothing 20, \varnothing 25, \varnothing 28, \varnothing 32$**

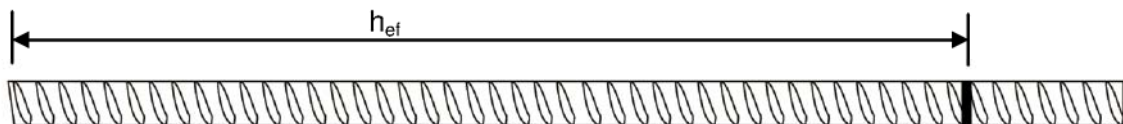

- Minimum value of related rip area  $f_{R,min}$  according to EN 1992-1-1:2004+AC:2010
- Rib height of the bar shall be in the range  $0,05d \leq h \leq 0,07d$   
(d: Nominal diameter of the bar; h: Rip height of the bar)

**Interfixings Injection system Easy-FIX for concrete**

**Product description**

Threaded rod and reinforcing bar

**Annex A3**

**Table A1: Materials**

Part	Designation	Material
<b>Steel, zinc plated <math>\geq 5 \mu\text{m}</math> acc. to EN ISO 4042:1999 or Steel, hot-dip galvanised <math>\geq 40 \mu\text{m}</math> acc. to EN ISO 1461:2009 and EN ISO 10684:2004+AC:2009</b>		
1	Anchor rod	Steel, EN 10087:1998 or EN 10263:2001 Property class 4.6, 5.8, 8.8, EN 1993-1-8:2005+AC:2009
2	Hexagon nut, EN ISO 4032:2012	Steel acc. to EN 10087:1998 or EN 10263:2001 Property class 4 (for class 4.6 rod) EN ISO 898-2:2012, Property class 5 (for class 5.8 rod) EN ISO 898-2:2012, Property class 8 (for class 8.8 rod) EN ISO 898-2:2012
3	Washer, EN ISO 887:2006, EN ISO 7089:2000, EN ISO 7093:2000 or EN ISO 7094:2000	Steel, zinc plated or hot-dip galvanised
<b>Stainless steel</b>		
1	Anchor rod	Material 1.4401 / 1.4404 / 1.4571, EN 10088-1:2005, > M24: Property class 50 EN ISO 3506-1:2009 ≤ M24: Property class 70 EN ISO 3506-1:2009
2	Hexagon nut, EN ISO 4032:2012	Material 1.4401 / 1.4404 / 1.4571 EN 10088:2005, > M24: Property class 50 (for class 50 rod) EN ISO 3506-2:2009 ≤ M24: Property class 70 (for class 70 rod) EN ISO 3506-2:2009
3	Washer, EN ISO 887:2006, EN ISO 7089:2000, EN ISO 7093:2000 or EN ISO 7094:2000	Material 1.4401, 1.4404 or 1.4571, EN 10088-1:2005
<b>High corrosion resistance steel</b>		
1	Anchor rod	Material 1.4529 / 1.4565, EN 10088-1:2005, > M24: Property class 50 EN ISO 3506-1:2009 ≤ M24: Property class 70 EN ISO 3506-1:2009
2	Hexagon nut, EN ISO 4032:2012	Material 1.4529 / 1.4565 EN 10088-1:2005, > M24: Property class 50 (for class 50 rod) EN ISO 3506-2:2009 ≤ M24: Property class 70 (for class 70 rod) EN ISO 3506-2:2009
3	Washer, EN ISO 887:2006, EN ISO 7089:2000, EN ISO 7093:2000 or EN ISO 7094:2000	Material 1.4529 / 1.4565, EN 10088-1:2005
<b>Reinforcing bars</b>		
1	Rebar EN 1992-1-1:2004+AC:2010, Annex C	Bars and de-coiled rods class B or C $f_{yk}$ and $k$ according to NDP or NCL of EN 1992-1-1/NA:2013 $f_{uk} = f_{tk} = k \cdot f_{yk}$

**Interfixings Injection system Easy-FIX for concrete**

**Product description**  
Materials

**Annex A4**



## Specifications of intended use

### Anchorage subject to:

- Static and quasi-static loads: M8 to M30, Rebar Ø8 to Ø32.
- Seismic action for Performance Category C1: M12 to M30, Rebar Ø12 to Ø32.

### Base materials:

- Reinforced or unreinforced normal weight concrete according to EN 206-1:2000.
- Strength classes C20/25 to C50/60 according to EN 206-1:2000.
- Non-cracked concrete: M8 to M30, Rebar Ø8 to Ø32.
- Cracked concrete: M12 to M30, Rebar Ø12 to Ø32.

### Temperature Range:

- I: - 40 °C to +40 °C (max long term temperature +24 °C and max short term temperature +40 °C)
- II: - 40 °C to +80 °C (max long term temperature +50 °C and max short term temperature +80 °C)
- III: - 40 °C to +120 °C (max long term temperature +72 °C and max short term temperature +120 °C)

### Use conditions (Environmental conditions):

- Structures subject to dry internal conditions (zinc coated steel, stainless steel or high corrosion resistant steel).
- Structures subject to external atmospheric exposure (including industrial and marine environment) and to permanently damp internal condition, if no particular aggressive conditions exist (stainless steel or high corrosion resistant steel).
- Structures subject to external atmospheric exposure and to permanently damp internal condition, if other particular aggressive conditions exist (high corrosion resistant steel).

Note: Particular aggressive conditions are e.g. permanent, alternating immersion in seawater or the splash zone of seawater, chloride atmosphere of indoor swimming pools or atmosphere with extreme chemical pollution (e.g. in desulphurization plants or road tunnels where de-icing materials are used).

### Design:

- Verifiable calculation notes and drawings are prepared taking account of the loads to be anchored. The position of the anchor is indicated on the design drawings (e. g. position of the anchor relative to reinforcement or to supports, etc.).
- Anchorages are designed under the responsibility of an engineer experienced in anchorages and concrete work.
- Anchorages under static or quasi-static actions are designed in accordance with:
  - EOTA Technical Report TR 029 "Design of bonded anchors", Edition September 2010 or
  - CEN/TS 1992-4:2009
- Anchorages under seismic actions (cracked concrete) are designed in accordance with:
  - EOTA Technical Report TR 045 "Design of Metal Anchors under Seismic Action", Edition February 2013
  - Anchorages shall be positioned outside of critical regions (e.g. plastic hinges) of the concrete structure.
  - Fastenings in stand-off installation or with a grout layer are not allowed.

### Installation:

- Dry or wet concrete: M8 to M30, Rebar Ø8 to Ø32.
- Flooded holes (not sea water): M8 to M16, Rebar Ø8 to Ø16.
- Hole drilling by hammer or compressed air drill mode.
- Overhead installation allowed.
- Anchor installation carried out by appropriately qualified personnel and under the supervision of the person responsible for technical matters of the site.

## Interfixings Injection system Easy-FIX for concrete

Intended Use  
Specifications

Annex B1

**Table B1: Installation parameters for threaded rod**

Anchor size		M 8	M 10	M 12	M 16	M 20	M 24	M 27	M 30	
Nominal drill hole diameter	$d_0$ [mm] =	10	12	14	18	24	28	32	35	
Effective anchorage depth	$h_{ef,min}$ [mm] =	64	80	96	128	160	192	216	240	
	$h_{ef,max}$ [mm] =	144	180	216	288	360	432	486	540	
Diameter of clearance hole in the fixture	$d_f$ [mm] ≤	9	12	14	18	22	26	30	33	
Diameter of steel brush	$d_b$ [mm] ≥	12	14	16	20	26	30	34	37	
Torque moment	$T_{inst}$ [Nm] ≤	10	20	40	80	120	160	180	200	
Thickness of fixture	$t_{fix,min}$ [mm] >	0								
	$t_{fix,max}$ [mm] <	1500								
Minimum thickness of member	$h_{min}$ [mm]	$h_{ef} + 30$ mm ≥ 100 mm			$h_{ef} + 2d_0$					
Minimum spacing	$s_{min}$ [mm]	40	50	60	80	100	120	135	150	
Minimum edge distance	$c_{min}$ [mm]	40	50	60	80	100	120	135	150	

**Table B2: Installation parameters for rebar**

Rebar size		Ø 8	Ø 10	Ø 12	Ø 14	Ø 16	Ø 20	Ø 25	Ø 28	Ø 32
Nominal drill hole diameter	$d_0$ [mm] =	12	14	16	18	20	24	32	35	40
Effective anchorage depth	$h_{ef,min}$ [mm] =	64	80	96	112	128	160	200	224	256
	$h_{ef,max}$ [mm] =	144	180	216	252	288	360	450	504	576
Diameter of steel brush	$d_b$ [mm] ≥	14	16	18	20	22	26	34	37	41,5
Minimum thickness of member	$h_{min}$ [mm]	$h_{ef} + 30$ mm ≥ 100 mm			$h_{ef} + 2d_0$					
Minimum spacing	$s_{min}$ [mm]	40	50	60	70	80	100	125	140	160
Minimum edge distance	$c_{min}$ [mm]	40	50	60	70	80	100	125	140	160

**Interfixings Injection system Easy-FIX for concrete**

**Intended Use**  
Installation parameters

**Annex B2**

**Table B3: Parameter cleaning and setting tools**

Anchor	Size (mm)	Nominal drill bit diameter $d_0$ (mm)	Steel Brush $d_b$ (mm)	Steel Brush (min brush diameter) $d_{b,min}$ (mm)	Piston plug
					
<b>Threaded Rod</b> 	M8	10,0	12,0	10,5	
	M10	12,0	14,0	12,5	
	M12	14,0	16,0	14,5	
	M16	18,0	20,0	18,5	
	M20	24,0	26,0	24,5	#24
	M24	28,0	30,0	28,5	#28
	M27	32,0	34,0	32,5	#32
	M30	35,0	37,0	35,5	#35
<b>Rebar</b> 	Ø8	12,0	14,0	12,5	
	Ø10	14,0	16,0	14,5	
	Ø12	16,0	18,0	16,5	
	Ø14	18,0	20,0	18,5	
	Ø16	20,0	22,0	20,5	
	Ø20	24,0	26,0	24,5	#24
	Ø25	32,0	34,0	32,5	#32
	Ø28	35,0	37,0	35,5	#35
	Ø32	40,0	41,5	38,5	#38

**Hand pump (volume 750 ml)**

Drill bit diameter ( $d_0$ ): 10 mm to 20 mm



**Compressed air tool (min 6 bar)**

Drill bit diameter ( $d_0$ ): 10 mm to 40 mm



**Interfixings Injection system Easy-FIX for concrete**

**Intended Use**

Cleaning and setting tools

**Annex B3**

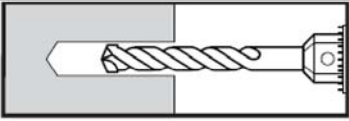
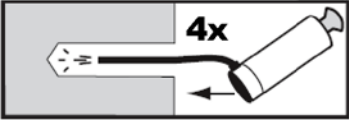
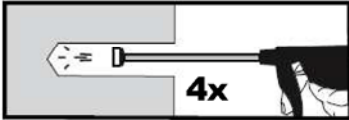
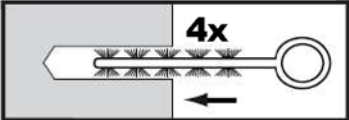
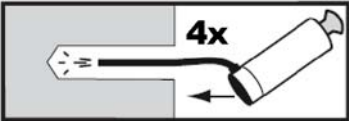
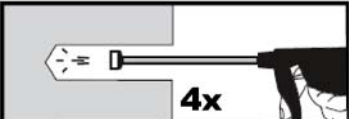
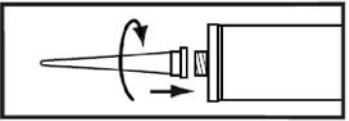
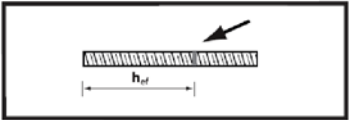
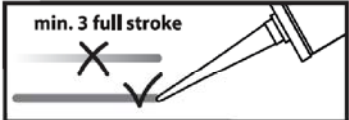
Installation instructions	
	<p>1. Drill with hammer drill a hole into the base material to the size and embedment depth required by the selected anchor (Table B1 or Table B2).</p>
	<p><b>Attention! Standing water in the bore hole must be removed before cleaning.</b></p> <p>2a. Starting from the bottom or back of the bore hole, blow the hole clean with compressed air (min. 6 bar) or a hand pump (Annex B3) a minimum of four times. If the bore hole ground is not reached an extension shall be used.</p> <p>The hand-pump can be used for anchor sizes up to bore hole diameter 20 mm.</p>
or	
	<p>For bore holes larger than 20 mm or deeper 240 mm, compressed air (min. 6 bar) <b>must</b> be used.</p>
	<p>2b. Check brush diameter (Table B3) and attach the brush to a drilling machine or a battery screwdriver. Brush the hole with an appropriate sized wire brush <math>&gt; d_{b,min}</math> (Table B3) a minimum of four times. If the bore hole ground is not reached with the brush, a brush extension shall be used (Table B3).</p>
	<p>2c. Finally blow the hole clean again with compressed air or a hand pump (Annex B3) a minimum of four times. If the bore hole ground is not reached an extension shall be used.</p> <p>The hand-pump can be used for anchor sizes up to bore hole diameter 20 mm. For bore holes larger than 20 mm or deeper 240 mm, compressed air (min. 6 bar) <b>must</b> be used.</p>
or	
	<p><b>After cleaning, the bore hole has to be protected against re-contamination in an appropriate way, until dispensing the mortar. If necessary, the cleaning repeated has to be directly before dispensing the mortar.</b></p> <p><b>In-flowing water must not contaminate the bore hole again.</b></p>
	<p>3. Attach a supplied static-mixing nozzle to the cartridge and load the cartridge into the correct dispensing tool. For every working interruption longer than the recommended working time (Table B4) as well as for new cartridges, a new static-mixer shall be used.</p>
	<p>4. Prior to inserting the anchor rod into the filled bore hole, the position of the embedment depth shall be marked on the anchor rods.</p>
	<p>5. Prior to dispensing into the anchor hole, squeeze out separately a minimum of three full strokes and discard non-uniformly mixed adhesive components until the mortar shows a consistent colour.</p>
<p><b>Interfixings Injection system Easy-FIX for concrete</b></p>	
<p><b>Intended use</b> Installation instructions</p>	<p><b>Annex B4</b></p>

### Installation instructions (continuation)

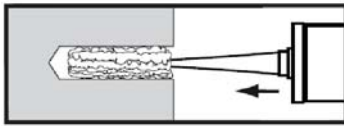

6. Starting from the bottom or back of the cleaned anchor hole fill the hole up to approximately two-thirds with adhesive. Slowly withdraw the static mixing nozzle as the hole fills to avoid creating air pockets. For embedment larger than 190 mm an extension nozzle shall be used. For overhead and horizontal installation in bore holes larger than  $\varnothing$  20 mm a piston plug and extension nozzle (Annex B3) shall be used. Observe the gel-/ working times given in Table B4.

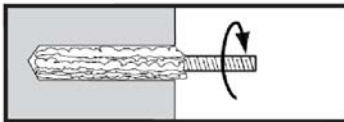

7. Push the threaded rod or reinforcing bar into the anchor hole while turning slightly to ensure positive distribution of the adhesive until the embedment depth is reached. The anchor should be free of dirt, grease, oil or other foreign material.

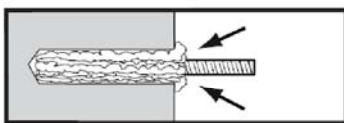

8. Be sure that the anchor is fully seated at the bottom of the hole and that excess mortar is visible at the top of the hole. If these requirements are not maintained, the application has to be renewed. For overhead application the anchor rod should be fixed (e.g. wedges).

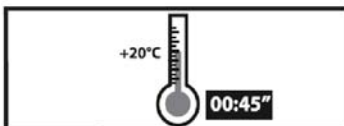

9. Allow the adhesive to cure to the specified time prior to applying any load or torque. Do not move or load the anchor until it is fully cured (attend Table B4).

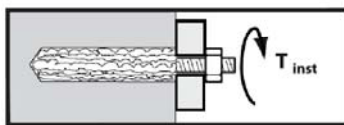

10. After full curing, the add-on part can be installed with the max. torque (Table B1) by using a calibrated torque wrench.

**Table B4: Minimum curing time**

Base material temperature	Gel time (working time)	Minimum curing time in dry concrete	Minimum curing time in wet concrete
-10°C to -4°C <sup>1)</sup>	90 min	24 h	48 h
-5°C to -1°C <sup>2)</sup>	90 min	14 h	24 h
+0°C to +5°C <sup>2)</sup>	45 min	7 h	14 h
+5°C to +9°C <sup>2)</sup>	25 min	2 h	4 h
+10°C to +19°C <sup>2)</sup>	15 min	80 min	160 min
+20°C to +29°C <sup>2)</sup>	6 min	45 min	90 min
+30°C to +34°C <sup>2)</sup>	4 min	25 min	50 min
+35°C to +39°C <sup>2)</sup>	2 min	20 min	40 min
+40 °C <sup>2)</sup>	1,5 min	15 min	30 min

<sup>1)</sup> Cartridge temperature **must** be at min. +15°C

<sup>2)</sup> Minimum cartridge temperature +5°C

### Interfixings Injection system Easy-FIX for concrete

Intended Use  
Installation instructions

**Annex B5**

**Table C1: Characteristic values of resistance for threaded rods under tension loads in non-cracked concrete (Design according to TR 029)**

Anchor size threaded rod			M 8	M 10	M 12	M 16	M 20	M 24	M 27	M 30	
<b>Steel failure</b>											
Characteristic tension resistance, Steel, property class 4.6	$N_{Rk,s}$	[kN]	15	23	34	63	98	141	184	224	
Characteristic tension resistance, Steel, property class 5.8	$N_{Rk,s}$	[kN]	18	29	42	78	122	176	230	280	
Characteristic tension resistance, Steel, property class 8.8	$N_{Rk,s}$	[kN]	29	46	67	125	196	282	368	449	
Characteristic tension resistance, Stainless steel A4 and HCR, property class 50 (>M24) and 70 ( $\leq$ M24)	$N_{Rk,s}$	[kN]	26	41	59	110	171	247	230	281	
<b>Combined pull-out and concrete cone failure</b>											
Characteristic bond resistance in non-cracked concrete C20/25											
Temperature range I: 40°C/24°C	dry and wet concrete	$\tau_{Rk,ucr}$	[N/mm <sup>2</sup> ]	8,5	10,0	10,0	10,0	10,0	9,5	8,5	7,5
	flooded bore hole	$\tau_{Rk,ucr}$	[N/mm <sup>2</sup> ]	6,0	7,5	7,5	7,5	No Performance Determined (NPD)			
Temperature range II: 80°C/50°C	dry and wet concrete	$\tau_{Rk,ucr}$	[N/mm <sup>2</sup> ]	6,5	7,5	7,5	7,5	7,5	7,0	6,5	5,5
	flooded bore hole	$\tau_{Rk,ucr}$	[N/mm <sup>2</sup> ]	4,5	5,5	5,5	5,5	No Performance Determined (NPD)			
Temperature range III: 120°C/72°C	dry and wet concrete	$\tau_{Rk,ucr}$	[N/mm <sup>2</sup> ]	4,5	5,5	5,5	5,5	5,5	5,5	4,5	3,5
	flooded bore hole	$\tau_{Rk,ucr}$	[N/mm <sup>2</sup> ]	3,5	4,0	4,0	4,0	No Performance Determined (NPD)			
Increasing factors for concrete $\psi_c$	C30/37		1,04								
	C40/50		1,08								
	C50/60		1,10								
<b>Splitting failure</b>											
Edge distance $c_{cr,sp}$ [mm] for	$h / h_{ef} \geq 2,0$		$1,0 h_{ef}$								
	$2,0 > h / h_{ef} > 1,3$		$4,6 h_{ef} - 1,8 h$								
	$h / h_{ef} \leq 1,3$		$2,26 h_{ef}$								
Axial distance	$s_{cr,sp}$	[mm]	$2 c_{cr,sp}$								
Installation safety factor (dry and wet concrete)	$\gamma_2$		1,0	1,2							
Installation safety factor (flooded bore hole)	$\gamma_2$		1,4				No Performance Determined (NPD)				

**Interfixings Injection system Easy-FIX for concrete**

**Performances**

Characteristic values of resistance for threaded rods under tension loads in non-cracked concrete (Design according to TR 029)

**Annex C1**

**Table C2: Characteristic values of resistance for threaded rods under tension loads in cracked concrete (Design according to TR 029 and TR 045)**

Anchor size threaded rod			M 12	M 16	M 20	M24	M 27	M 30	
<b>Steel failure</b>									
Characteristic tension resistance, Steel, property class 4.6	$N_{Rk,s}=N_{Rk,s,seis,C1}$	[kN]	34	63	98	141	184	224	
Characteristic tension resistance, Steel, property class 5.8	$N_{Rk,s}=N_{Rk,s,seis,C1}$	[kN]	42	78	122	176	230	280	
Characteristic tension resistance, Steel, property class 8.8	$N_{Rk,s}=N_{Rk,s,seis,C1}$	[kN]	67	125	196	282	368	449	
Characteristic tension resistance, Stainless steel A4 and HCR, property class 50 (>M24) and 70 ( $\leq$ M24)	$N_{Rk,s}=N_{Rk,s,seis,C1}$	[kN]	59	110	171	247	230	281	
<b>Combined pull-out and concrete cone failure</b>									
Characteristic bond resistance in cracked concrete C20/25									
Temperature range I: 40°C/24°C	dry and wet concrete	$\tau_{Rk,cr}$	[N/mm <sup>2</sup> ]	4,5	4,5	4,5	4,5	5,0	5,0
		$\tau_{Rk,seis,C1}$	[N/mm <sup>2</sup> ]	3,1	3,1	3,1	3,1	3,5	3,5
	flooded bore hole	$\tau_{Rk,cr}$	[N/mm <sup>2</sup> ]	4,5	4,5	No Performance Determined (NPD)			
		$\tau_{Rk,seis,C1}$	[N/mm <sup>2</sup> ]	3,1	3,1				
Temperature range II: 80°C/50°C	dry and wet concrete	$\tau_{Rk,cr}$	[N/mm <sup>2</sup> ]	3,0	3,0	3,0	3,0	4,0	4,0
		$\tau_{Rk,seis,C1}$	[N/mm <sup>2</sup> ]	2,0	2,0	2,0	2,1	2,8	2,8
	flooded bore hole	$\tau_{Rk,cr}$	[N/mm <sup>2</sup> ]	3,0	3,0	No Performance Determined (NPD)			
		$\tau_{Rk,seis,C1}$	[N/mm <sup>2</sup> ]	2,0	2,0				
Temperature range II: 120°C/72°C	dry and wet concrete	$\tau_{Rk,cr}$	[N/mm <sup>2</sup> ]	2,5	2,5	2,5	2,5	3,0	3,0
		$\tau_{Rk,seis,C1}$	[N/mm <sup>2</sup> ]	1,7	1,7	1,7	1,7	2,1	2,1
	flooded bore hole	$\tau_{Rk,cr}$	[N/mm <sup>2</sup> ]	2,5	2,5	No Performance Determined (NPD)			
		$\tau_{Rk,seis,C1}$	[N/mm <sup>2</sup> ]	1,7	1,7				
Increasing factors for concrete $\psi_c$	C30/37		1,04						
	C40/50		1,08						
	C50/60		1,10						
Installation safety factor (dry and wet concrete)	$\gamma_2$		1,2						
Installation safety factor (flooded bore hole)	$\gamma_2$		1,4		No Performance Determined (NPD)				

**Interfixings Injection system Easy-FIX for concrete**

**Performances**

Characteristic values of resistance for threaded rods under tension loads in cracked concrete (Design according to TR 029 and TR 045)

**Annex C2**

**Table C3: Characteristic values of resistance for threaded rods under shear loads in cracked and non-cracked concrete (Design according to TR 029 and TR 045)**

Anchor size threaded rod			M 8	M 10	M 12	M 16	M 20	M 24	M 27	M 30
<b>Steel failure without lever arm</b>										
Characteristic shear resistance, Steel, property class 4.6	$V_{Rk,s}$	[kN]	7	12	17	31	49	71	92	112
	$V_{Rk,s,seis,C1}$	[kN]	No Performance Determined (NPD)			12	22	34	50	65
Characteristic shear resistance, Steel, property class 5.8	$V_{Rk,s}$	[kN]	9	15	21	39	61	88	115	140
	$V_{Rk,s,seis,C1}$	[kN]	No Performance Determined (NPD)			15	27	43	62	81
Characteristic shear resistance, Steel, property class 8.8	$V_{Rk,s}$	[kN]	15	23	34	63	98	141	184	224
	$V_{Rk,s,seis,C1}$	[kN]	No Performance Determined (NPD)			24	44	69	99	129
Characteristic shear resistance, Stainless steel A4 and HCR, property class 50 (>M24) and 70 ( $\leq$ M24)	$V_{Rk,s}$	[kN]	13	20	30	55	86	124	115	140
	$V_{Rk,s,seis,C1}$	[kN]	No Performance Determined (NPD)			21	39	60	87	81
<b>Steel failure with lever arm</b>										
Characteristic bending moment, Steel, property class 4.6	$M^0_{Rk,s}$	[Nm]	15	30	52	133	260	449	666	900
	$M^0_{Rk,s,seis,C1}$	[Nm]	No Performance Determined (NPD)							
Characteristic bending moment, Steel, property class 5.8	$M^0_{Rk,s}$	[Nm]	19	37	65	166	324	560	833	1123
	$M^0_{Rk,s,seis,C1}$	[Nm]	No Performance Determined (NPD)							
Characteristic bending moment, Steel, property class 8.8	$M^0_{Rk,s}$	[Nm]	30	60	105	266	519	896	1333	1797
	$M^0_{Rk,s,seis,C1}$	[Nm]	No Performance Determined (NPD)							
Characteristic bending moment, Stainless steel A4 and HCR, property class 50 (>M24) and 70 ( $\leq$ M24)	$M^0_{Rk,s}$	[Nm]	26	52	92	232	454	784	832	1125
	$M^0_{Rk,s,seis,C1}$	[Nm]	No Performance Determined (NPD)							
<b>Concrete pry-out failure</b>										
Factor k in equation (5.7) of Technical Report TR 029 for the design of Bonded Anchors							2,0			
Installation safety factor		$\gamma_2$	1,0							
<b>Concrete edge failure</b>										
See section 5.2.3.4 of Technical Report TR 029 for the design of Bonded Anchors										
Installation safety factor		$\gamma_2$	1,0							

**Interfixings Injection system Easy-FIX for concrete**

**Performances**

Characteristic values of resistance for threaded rods under shear loads in cracked and non-cracked concrete, (Design according to TR 029 and TR 045)

**Annex C3**



**Table C4: Characteristic values of resistance for rebar under tension loads in non-cracked concrete (Design according to TR 029)**

Anchor size reinforcing bar			Ø 8	Ø 10	Ø 12	Ø 14	Ø 16	Ø 20	Ø 25	Ø 28	Ø 32	
<b>Steel failure</b>												
Characteristic tension resistance	$N_{Rk,s}$	[kN]	$A_s \times f_{tk}$									
<b>Combined pull-out and concrete cone failure</b>												
Characteristic bond resistance in uncracked concrete C20/25												
Temperature range I: 40°C/24°C	dry and wet concrete	$\tau_{Rk,ucr}$	[N/mm <sup>2</sup> ]	8,5	10	10	10	10	10	9,0	8,0	7,0
	flooded bore hole	$\tau_{Rk,ucr}$	[N/mm <sup>2</sup> ]	6,0	7,5	7,5	7,5	7,5	No Performance Determined (NPD)			
Temperature range II: 80°C/50°C	dry and wet concrete	$\tau_{Rk,ucr}$	[N/mm <sup>2</sup> ]	6,5	7,5	7,5	7,5	7,5	7,5	7,0	6,0	5,0
	flooded bore hole	$\tau_{Rk,ucr}$	[N/mm <sup>2</sup> ]	4,5	5,5	5,5	5,5	5,5	No Performance Determined (NPD)			
Temperature range III: 120°C/72°C	dry and wet concrete	$\tau_{Rk,ucr}$	[N/mm <sup>2</sup> ]	4,5	5,5	5,5	5,5	5,5	5,5	5,0	4,5	4,0
	flooded bore hole	$\tau_{Rk,ucr}$	[N/mm <sup>2</sup> ]	3,5	4,0	4,0	4,0	4,0	No Performance Determined (NPD)			
Increasing factors for concrete $\psi_c$	C30/37		1,04									
	C40/50		1,08									
	C50/60		1,10									
<b>Splitting failure</b>												
Edge distance $c_{cr,sp}$ [mm] for	$h / h_{ef} \geq 2,0$		1,0 $h_{ef}$									
	$2,0 > h / h_{ef} > 1,3$		4,6 $h_{ef} - 1,8 h$									
	$h / h_{ef} \leq 1,3$		2,26 $h_{ef}$									
Axial distance	$s_{cr,sp}$	[mm]	2 $c_{cr,sp}$									
Installation safety factor (dry and wet concrete)	$\gamma_2$		1,0	1,2								
Installation safety factor (flooded bore hole)	$\gamma_2$		1,4						No Performance Determined (NPD)			

**Interfixings Injection system Easy-FIX for concrete**

**Performances**

Characteristic values of resistance for rebar under tension loads in non-cracked concrete (Design according to TR 029)

**Annex C4**

**Table C5: Characteristic values of resistance for rebar under tension loads in cracked concrete (Design according to TR 029 and TR 045)**

Anchor size reinforcing bar			Ø 12	Ø 14	Ø 16	Ø 20	Ø 25	Ø 28	Ø 32	
<b>Steel failure</b>										
Characteristic tension resistance	$N_{FRk,s} = N_{FRk,s,seis,C1}$	[kN]	$A_s \times f_{tk}$							
<b>Combined pull-out and concrete cone failure</b>										
Characteristic bond resistance in cracked concrete C20/25										
Temperature range I: 40°C/24°C	dry and wet concrete	$\tau_{FRk,cr}$	[N/mm <sup>2</sup> ]	4,5	4,5	4,5	4,5	4,5	5,0	5,0
		$\tau_{FRk,seis,C1}$	[N/mm <sup>2</sup> ]	3,1	3,1	3,1	3,1	3,1	3,5	3,5
	flooded bore hole	$\tau_{FRk,cr}$	[N/mm <sup>2</sup> ]	4,5	4,5	4,5	No Performance Determined (NPD)			
		$\tau_{FRk,seis,C1}$	[N/mm <sup>2</sup> ]	3,1	3,1	3,1	No Performance Determined (NPD)			
Temperature range II: 80°C/50°C	dry and wet concrete	$\tau_{FRk,cr}$	[N/mm <sup>2</sup> ]	3,0	3,0	3,0	3,0	3,0	4,0	4,0
		$\tau_{FRk,seis,C1}$	[N/mm <sup>2</sup> ]	2,0	2,0	2,0	2,0	2,1	2,8	2,8
	flooded bore hole	$\tau_{FRk,cr}$	[N/mm <sup>2</sup> ]	3,0	3,0	3,0	No Performance Determined (NPD)			
		$\tau_{FRk,seis,C1}$	[N/mm <sup>2</sup> ]	2,0	2,0	2,0	No Performance Determined (NPD)			
Temperature range II: 120°C/72°C	dry and wet concrete	$\tau_{FRk,cr}$	[N/mm <sup>2</sup> ]	2,5	2,5	2,5	2,5	2,5	3,0	3,0
		$\tau_{FRk,seis,C1}$	[N/mm <sup>2</sup> ]	1,7	1,7	1,7	1,7	1,7	2,1	2,1
	flooded bore hole	$\tau_{FRk,cr}$	[N/mm <sup>2</sup> ]	2,5	2,5	2,5	No Performance Determined (NPD)			
		$\tau_{FRk,seis,C1}$	[N/mm <sup>2</sup> ]	1,7	1,7	1,7	No Performance Determined (NPD)			
Increasing factors for concrete $\psi_c$	C30/37		1,04							
	C40/50		1,08							
	C50/60		1,10							
Installation safety factor (dry and wet concrete)		$\gamma_2$	1,2							
Installation safety factor (flooded bore hole)		$\gamma_2$	1,4				No Performance Determined (NPD)			

**Interfixings Injection system Easy-FIX for concrete**

**Performances**

Characteristic values of resistance for rebar under tension loads in cracked concrete (Design according to TR 029 and TR 045)

**Annex C5**

**Table C6: Characteristic values of resistance for rebar under shear loads in cracked and non-cracked concrete (Design according to TR 029 and TR 045)**

Anchor size reinforcing bar		Ø 8	Ø 10	Ø 12	Ø 14	Ø 16	Ø 20	Ø 25	Ø 28	Ø 32
<b>Steel failure without lever arm</b>										
Characteristic shear resistance	$V_{Rk,s}$	[kN]	$0,50 \times A_s \times f_{uk}$							
	$V_{Rk,s,seis,C1}$	[kN]	$0,35 \times A_s \times f_{uk}$							
<b>Steel failure with lever arm</b>										
Characteristic bending moment	$M_{Rk,s}^0$	[Nm]	$1,2 \cdot W_{el} \cdot f_{uk}$							
	$M_{Rk,s,seis,C1}^0$	[Nm]	No Performance Determined (NPD)							
<b>Concrete pry-out failure</b>										
Factor k in equation (5.7) of Technical Report TR 029 for the design of bonded anchors		2,0								
Installation safety factor	$\gamma_2$	1,0								
<b>Concrete edge failure</b>										
See section 5.2.3.4 of Technical Report TR 029 for the design of Bonded Anchors										
Installation safety factor	$\gamma_2$	1,0								

**Interfixings Injection system Easy-FIX for concrete**

**Performances**

Characteristic values of resistance for rebar under shear loads in cracked and non-cracked concrete, (Design according to TR 029 and TR 045)

**Annex C6**

**Table C7: Characteristic values of resistance for threaded rods under tension loads in non-cracked concrete (Design according to CEN/TS 1992-4)**

Anchor size threaded rod			M 8	M 10	M 12	M 16	M 20	M24	M 27	M 30	
<b>Steel failure</b>											
Characteristic tension resistance, Steel, property class 4.6	$N_{Rk,s}$	[kN]	15	23	34	63	98	141	184	224	
Characteristic tension resistance, Steel, property class 5.8	$N_{Rk,s}$	[kN]	18	29	42	78	122	176	230	280	
Characteristic tension resistance, Steel, property class 8.8	$N_{Rk,s}$	[kN]	29	46	67	125	196	282	368	449	
Characteristic tension resistance, Stainless steel A4 and HCR, property class 50 (>M24) and 70 ( $\leq$ M24)	$N_{Rk,s}$	[kN]	26	41	59	110	171	247	230	281	
<b>Combined pull-out and concrete failure</b>											
Characteristic bond resistance in non-cracked concrete C20/25											
Temperature range I: 40°C/24°C	dry and wet concrete	$\tau_{Rk,ucr}$	[N/mm <sup>2</sup> ]	8,5	10,0	10,0	10,0	10,0	9,5	8,5	7,5
	flooded bore hole	$\tau_{Rk,ucr}$	[N/mm <sup>2</sup> ]	6,0	7,5	7,5	7,5	No Performance Determined (NPD)			
Temperature range II: 80°C/50°C	dry and wet concrete	$\tau_{Rk,ucr}$	[N/mm <sup>2</sup> ]	6,5	7,5	7,5	7,5	7,5	7,0	6,5	5,5
	flooded bore hole	$\tau_{Rk,ucr}$	[N/mm <sup>2</sup> ]	4,5	5,5	5,5	5,5	No Performance Determined (NPD)			
Temperature range III: 120°C/72°C	dry and wet concrete	$\tau_{Rk,ucr}$	[N/mm <sup>2</sup> ]	4,5	5,5	5,5	5,5	5,5	5,5	4,5	3,5
	flooded bore hole	$\tau_{Rk,ucr}$	[N/mm <sup>2</sup> ]	3,5	4,0	4,0	4,0	No Performance Determined (NPD)			
Increasing factors for concrete $\psi_c$	C30/37			1,04							
	C40/50			1,08							
	C50/60			1,10							
Factor according to CEN/TS 1992-4-5 Section 6.2.2.3	$k_8$	[-]	10,1								
<b>Concrete cone failure</b>											
Factor according to CEN/TS 1992-4-5 Section 6.2.3.1	$k_{ucr}$	[-]	10,1								
Edge distance	$c_{cr,N}$	[mm]	1,5 $h_{ef}$								
Axial distance	$s_{cr,N}$	[mm]	3,0 $h_{ef}$								
<b>Splitting failure</b>											
Edge distance $c_{cr,sp}$ [mm] for	$h / h_{ef} \geq 2,0$			1,0 $h_{ef}$							
	$2,0 > h / h_{ef} > 1,3$			4,6 $h_{ef} - 1,8 h$							
	$h / h_{ef} \leq 1,3$			2,26 $h_{ef}$							
Axial distance	$s_{cr,sp}$	[mm]	2 $c_{cr,sp}$								
Installation safety factor (dry and wet concrete)	$\gamma_{inst}$		1,0	1,2							
Installation safety factor (flooded bore hole)	$\gamma_{inst}$		1,4					No Performance Determined (NPD)			

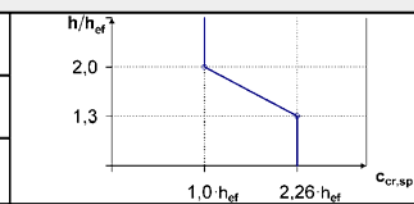

**Interfixings Injection system Easy-FIX for concrete**

**Performances**

Characteristic values of resistance for threaded rods under tension loads in non-cracked concrete (Design according to CEN/TS 1992-4)

**Annex C7**

**Table C8: Characteristic values of resistance for threaded rods under tension loads in cracked concrete (Design according to CEN/TS 1992-4 and TR 045)**

Anchor size threaded rod			M 12	M 16	M 20	M24	M27	M30	
<b>Steel failure</b>									
Characteristic tension resistance, Steel, property class 4.6	$N_{Rk,s}=N_{Rk,s,seis,C1}$	[kN]	34	63	98	141	184	224	
Characteristic tension resistance, Steel, property class 5.8	$N_{Rk,s}=N_{Rk,s,seis,C1}$	[kN]	42	78	122	176	230	280	
Characteristic tension resistance, Steel, property class 8.8	$N_{Rk,s}=N_{Rk,s,seis,C1}$	[kN]	67	125	196	282	368	449	
Characteristic tension resistance, Stainless steel A4 and HCR, property class 50 (>M24) and 70 ( $\leq$ M24)	$N_{Rk,s}=N_{Rk,s,seis,C1}$	[kN]	59	110	171	247	230	281	
<b>Combined pull-out and concrete failure</b>									
Characteristic bond resistance in cracked concrete C20/25									
Temperature range I: 40°C/24°C	dry and wet concrete	$\tau_{Rk,cr}$	[N/mm <sup>2</sup> ]	4,5	4,5	4,5	4,5	5,0	5,0
		$\tau_{Rk,seis,C1}$	[N/mm <sup>2</sup> ]	3,1	3,1	3,1	3,1	3,7	3,7
	flooded bore hole	$\tau_{Rk,cr}$	[N/mm <sup>2</sup> ]	4,5	4,5	No Performance Determined (NPD)			
		$\tau_{Rk,seis,C1}$	[N/mm <sup>2</sup> ]	3,1	3,1				
Temperature range II: 80°C/50°C	dry and wet concrete	$\tau_{Rk,cr}$	[N/mm <sup>2</sup> ]	3,0	3,0	3,0	3,0	4,0	4,0
		$\tau_{Rk,seis,C1}$	[N/mm <sup>2</sup> ]	2,0	2,0	2,0	2,0	2,7	2,7
	flooded bore hole	$\tau_{Rk,cr}$	[N/mm <sup>2</sup> ]	3,0	3,0	No Performance Determined (NPD)			
		$\tau_{Rk,seis,C1}$	[N/mm <sup>2</sup> ]	2,0	2,0				
Temperature range II: 120°C/72°C	dry and wet concrete	$\tau_{Rk,cr}$	[N/mm <sup>2</sup> ]	2,5	2,5	2,5	2,5	3,0	3,0
		$\tau_{Rk,seis,C1}$	[N/mm <sup>2</sup> ]	1,7	1,7	1,7	1,7	2,1	2,1
	flooded bore hole	$\tau_{Rk,cr}$	[N/mm <sup>2</sup> ]	2,5	2,5	No Performance Determined (NPD)			
		$\tau_{Rk,seis,C1}$	[N/mm <sup>2</sup> ]	1,7	1,7				
Increasing factors for concrete $\psi_c$	C30/37		1,04						
	C40/50		1,08						
	C50/60		1,10						
Factor according to CEN/TS 1992-4-5 Section 6.2.2.3	$k_8$	[-]	7,2						
<b>Concrete cone failure</b>									
Factor according to CEN/TS 1992-4-5 Section 6.2.3.1	$k_{cr}$	[-]	7,2						
Edge distance	$c_{cr,N}$	[mm]	1,5 $h_{et}$						
Axial distance	$s_{cr,N}$	[mm]	3,0 $h_{et}$						
Installation safety factor (dry and wet concrete)	$\gamma_{inst}$		1,2						
Installation safety factor (flooded bore hole)	$\gamma_{inst}$		1,4	No Performance Determined (NPD)					

**Interfixings Injection system Easy-FIX for concrete**

**Performances**

Characteristic values of resistance for threaded rods under tension loads in cracked concrete (Design according to CEN/TS 1992-4 and TR 045)

**Annex C8**

**Table C9: Characteristic values of resistance for threaded rods under shear loads in cracked and non-cracked concrete (Design according to CEN/TS 1992-4 and TR 045)**

Anchor size threaded rod		M 8	M 10	M 12	M 16	M 20	M24	M 27	M 30	
<b>Steel failure without lever arm</b>										
Characteristic shear resistance, Steel, property class 4.6	$V_{Fk,s}$	[kN]	7	12	17	31	49	71	92	112
	$V_{Fk,s,seis,C1}$	[kN]	No Performance Determined (NPD)		12	22	34	50	65	78
Characteristic shear resistance, Steel, property class 5.8	$V_{Fk,s}$	[kN]	9	15	21	39	61	88	115	140
	$V_{Fk,s,seis,C1}$	[kN]	No Performance Determined (NPD)		15	27	43	62	81	98
Characteristic shear resistance, Steel, property class 8.8	$V_{Fk,s}$	[kN]	15	23	34	63	98	141	184	224
	$V_{Fk,s,seis,C1}$	[kN]	No Performance Determined (NPD)		24	44	69	99	129	157
Characteristic shear resistance, Stainless steel A4 and HCR, property class 50 (>M24) and 70 ( $\leq$ M24)	$V_{Fk,s}$	[kN]	13	20	30	55	86	124	115	140
	$V_{Fk,s,seis,C1}$	[kN]	No Performance Determined (NPD)		21	39	60	87	81	98
Ductility factor according to CEN/TS 1992-4-5 Section 6.3.2.1	$k_2$		0,8							
<b>Steel failure with lever arm</b>										
Characteristic bending moment, Steel, property class 4.6	$M^0_{Fk,s}$	[Nm]	15	30	52	133	260	449	666	900
	$M^0_{Fk,s,seis,C1}$	[Nm]	No Performance Determined (NPD)							
Characteristic bending moment, Steel, property class 5.8	$M^0_{Fk,s}$	[Nm]	19	37	65	166	324	560	833	1123
	$M^0_{Fk,s,seis,C1}$	[Nm]	No Performance Determined (NPD)							
Characteristic bending moment, Steel, property class 8.8	$M^0_{Fk,s}$	[Nm]	30	60	105	266	519	896	1333	1797
	$M^0_{Fk,s,seis,C1}$	[Nm]	No Performance Determined (NPD)							
Characteristic bending moment, Stainless steel A4 and HCR, property class 50 (>M24) and 70 ( $\leq$ M24)	$M^0_{Fk,s}$	[Nm]	26	52	92	232	454	784	832	1125
	$M^0_{Fk,s,seis,C1}$	[Nm]	No Performance Determined (NPD)							
<b>Concrete pry-out failure</b>										
Factor in equation (27) of CEN/TS 1992-4-5 Section 6.3.3	$k_3$		2,0							
Installation safety factor	$\gamma_{inst}$		1,0							
<b>Concrete edge failure<sup>3)</sup></b>										
Effective length of anchor	$l_f$	[mm]	$l_f = \min(h_{ef}; 8 d_{nom})$							
Outside diameter of anchor	$d_{nom}$	[mm]	8	10	12	16	20	24	27	30
Installation safety factor	$\gamma_{inst}$		1,0							

**Interfixings Injection system Easy-FIX for concrete**

**Performances**

Characteristic values of resistance for threaded rods under shear loads in cracked and non-cracked concrete, (Design according to CEN/TS 1992-4 and TR 045)

**Annex C9**

**Table C10: Characteristic values of resistance for rebar under tension loads in non-cracked concrete (Design according to CEN/TS 1992-4)**

Anchor size reinforcing bar			Ø 8	Ø 10	Ø 12	Ø 14	Ø 16	Ø 20	Ø 25	Ø 28	Ø 32	
<b>Steel failure</b>												
Characteristic tension resistance		$N_{Rk,s}$	[kN]	$A_s \times f_{uk}$								
<b>Combined pull-out and concrete failure</b>												
Characteristic bond resistance in non-cracked concrete C20/25												
Temperature range I: 40°C/24°C	dry and wet concrete	$\tau_{Rk,ucr}$	[N/mm <sup>2</sup> ]	8,5	10	10	10	10	10	9,0	8,0	7,0
	flooded bore hole	$\tau_{Rk,ucr}$	[N/mm <sup>2</sup> ]	6,0	7,5	7,5	7,5	7,5	No Performance Determined (NPD)			
Temperature range II: 80°C/50°C	dry and wet concrete	$\tau_{Rk,ucr}$	[N/mm <sup>2</sup> ]	6,5	7,5	7,5	7,5	7,5	7,5	7,0	6,0	5,0
	flooded bore hole	$\tau_{Rk,ucr}$	[N/mm <sup>2</sup> ]	4,5	5,5	5,5	5,5	5,5	No Performance Determined (NPD)			
Temperature range III: 120°C/72°C	dry and wet concrete	$\tau_{Rk,ucr}$	[N/mm <sup>2</sup> ]	4,5	5,5	5,5	5,5	5,5	5,5	5,0	4,5	4,0
	flooded bore hole	$\tau_{Rk,ucr}$	[N/mm <sup>2</sup> ]	3,5	4,0	4,0	4,0	4,0	No Performance Determined (NPD)			
Increasing factors for concrete $\psi_c$		C30/37		1,04								
		C40/50		1,08								
		C50/60		1,10								
Factor according to CEN/TS 1992-4-5 Section 6.2.2.3		$k_8$	[-]	10,1								
<b>Concrete cone failure</b>												
Factor according to CEN/TS 1992-4-5 Section 6.2.3.1		$k_{ucr}$	[-]	10,1								
Edge distance		$c_{or,N}$	[mm]	1,5 $h_{ef}$								
Axial distance		$s_{or,N}$	[mm]	3,0 $h_{ef}$								
<b>Splitting failure</b>												
Edge distance $c_{or,sp}$ [mm] for		$h / h_{ef} \geq 2,0$		1,0 $h_{ef}$								
		$2,0 > h / h_{ef} > 1,3$		4,6 $h_{ef}$ - 1,8 h								
		$h / h_{ef} \leq 1,3$		2,26 $h_{ef}$								
Axial distance		$s_{or,sp}$	[mm]	2 $c_{or,sp}$								
Partial safety factor (dry and wet concrete)		$\gamma_{inst}$		1,0	1,2							
Partial safety factor (flooded bore hole)		$\gamma_{inst}$		1,4					No Performance Determined (NPD)			

**Interfixings Injection system Easy-FIX for concrete**

**Performances**

Characteristic values of resistance for rebar under tension loads in non-cracked concrete (Design according to CEN/TS 1992-4)

**Annex C10**

**Table C11: Characteristic values of resistance for rebar under tension loads in cracked concrete (Design according to CEN/TS 1992-4 and TR 045)**

Anchor size reinforcing bar			Ø 12	Ø 14	Ø 16	Ø 20	Ø 25	Ø 28	Ø 32	
<b>Steel failure</b>										
Characteristic tension resistance	$N_{Rk,s}=N_{Rk,s,seis,C1}$	[kN]	$A_s \times f_{uk}$							
<b>Combined pull-out and concrete failure</b>										
Characteristic bond resistance in cracked concrete C20/25										
Temperature range I: 40°C/24°C	dry and wet concrete	$\tau_{Rk,cr}$	[N/mm <sup>2</sup> ]	4,5	4,5	4,5	4,5	4,5	5,0	5,0
		$\tau_{Rk,seis,C1}$	[N/mm <sup>2</sup> ]	3,1	3,1	3,1	3,1	3,1	3,5	3,5
	flooded bore hole	$\tau_{Rk,cr}$	[N/mm <sup>2</sup> ]	4,5	4,5	4,5	No Performance Determined (NPD)			
		$\tau_{Rk,seis,C1}$	[N/mm <sup>2</sup> ]	3,1	3,1	3,1				
Temperature range II: 80°C/50°C	dry and wet concrete	$\tau_{Rk,cr}$	[N/mm <sup>2</sup> ]	3,0	3,0	3,0	3,0	3,0	4,0	4,0
		$\tau_{Rk,seis,C1}$	[N/mm <sup>2</sup> ]	2,0	2,0	2,0	2,0	2,1	2,8	2,8
	flooded bore hole	$\tau_{Rk,cr}$	[N/mm <sup>2</sup> ]	3,0	3,0	3,0	No Performance Determined (NPD)			
		$\tau_{Rk,seis,C1}$	[N/mm <sup>2</sup> ]	2,0	2,0	2,0				
Temperature range II: 120°C/72°C	dry and wet concrete	$\tau_{Rk,cr}$	[N/mm <sup>2</sup> ]	2,5	2,5	2,5	2,5	2,5	3,0	3,0
		$\tau_{Rk,seis,C1}$	[N/mm <sup>2</sup> ]	1,7	1,7	1,7	1,7	1,7	2,1	2,1
	flooded bore hole	$\tau_{Rk,cr}$	[N/mm <sup>2</sup> ]	2,5	2,5	2,5	No Performance Determined (NPD)			
		$\tau_{Rk,seis,C1}$	[N/mm <sup>2</sup> ]	1,7	1,7	1,7				
Increasing factors for concrete $\psi_c$	C30/37		1,04							
	C40/50		1,08							
	C50/60		1,10							
Factor according to CEN/TS 1992-4-5 Section 6.2.2.3	$k_8$	[-]	7,2							
<b>Concrete cone failure</b>										
Factor according to CEN/TS 1992-4-5 Section 6.2.3.1	$k_{cr}$	[-]	7,2							
Edge distance	$c_{or,N}$	[mm]	1,5 $h_{ef}$							
Axial distance	$s_{or,N}$	[mm]	3,0 $h_{ef}$							
Installation safety factor (dry and wet concrete)	$\gamma_{inst}$		1,2							
Installation safety factor (flooded bore hole)	$\gamma_{inst}$		1,4			No Performance Determined (NPD)				

**Interfixings Injection system Easy-FIX for concrete**

**Performances**

Characteristic values of resistance for rebar under tension loads in cracked concrete  
(Design according to CEN/TS 1992-4 and TR 045)

**Annex C11**



**Table C12: Characteristic values of resistance for rebar under shear loads in cracked and non-cracked concrete (Design according to CEN/TS 1992-4 and TR 045)**

Anchor size reinforcing bar		Ø 8	Ø 10	Ø 12	Ø 14	Ø 16	Ø 20	Ø 25	Ø 28	Ø 32	
<b>Steel failure without lever arm</b>											
Characteristic shear resistance	$V_{FR,s}$	[kN]	$0,50 \times A_s \times f_{uk}$								
	$V_{FR,s,seis,C1}$	[kN]	$0,35 \times A_s \times f_{uk}$								
Ductility factor according to CEN/TS 1992-4-5 Section 6.3.2.1	$k_2$		0,8								
<b>Steel failure with lever arm</b>											
Characteristic bending moment	$M_{FR,s}^0$	[Nm]	$1,2 \cdot W_{el} \cdot f_{uk}$								
	$M_{FR,s,seis,C1}^0$	[Nm]	No Performance Determined (NPD)								
<b>Concrete pry-out failure</b>											
Factor in equation (27) of CEN/TS 1992-4-5 Section 6.3.3	$k_3$		2,0								
Installation safety factor	$\gamma_{inst}$		1,0								
<b>Concrete edge failure<sup>3)</sup></b>											
Effective length of anchor	$l_l$	[mm]	$l_l = \min(h_{ef}; 8 d_{nom})$								
Outside diameter of anchor	$d_{nom}$	[mm]	8	10	12	14	16	20	25	28	32
Installation safety factor	$\gamma_{inst}$		1,0								

**Interfixings Injection system Easy-FIX for concrete**

**Performances**

Characteristic values of resistance for rebar under shear loads in cracked and non-cracked concrete, (Design according to CEN/TS 1992-4 and TR 045)

**Annex C12**

**Table C13: Displacements under tension load<sup>1)</sup> (threaded rod)**

Anchor size threaded rod			M 8	M 10	M 12	M 16	M 20	M24	M 27	M 30	
<b>Non-cracked concrete C20/25</b>											
40°C/24°C	$\delta_{N0}$	[mm/(N/mm <sup>2</sup> )]	0,021	0,023	0,026	0,031	0,036	0,041	0,045	0,049	
	$\delta_{N\infty}$	[mm/(N/mm <sup>2</sup> )]	0,030	0,033	0,037	0,045	0,052	0,060	0,065	0,071	
80°C/50°C	$\delta_{N0}$	[mm/(N/mm <sup>2</sup> )]	0,050	0,056	0,063	0,075	0,088	0,100	0,110	0,119	
	$\delta_{N\infty}$	[mm/(N/mm <sup>2</sup> )]	0,072	0,081	0,090	0,108	0,127	0,145	0,159	0,172	
120°C/72°C	$\delta_{N0}$	[mm/(N/mm <sup>2</sup> )]	0,050	0,056	0,063	0,075	0,088	0,100	0,110	0,119	
	$\delta_{N\infty}$	[mm/(N/mm <sup>2</sup> )]	0,072	0,081	0,090	0,108	0,127	0,145	0,159	0,172	
<b>Cracked concrete C20/25</b>											
40°C/24°C	$\delta_{N0}$	[mm/(N/mm <sup>2</sup> )]	No Performance Determined (NPD)				0,070				
	$\delta_{N\infty}$	[mm/(N/mm <sup>2</sup> )]					0,105				
80°C/50°C	$\delta_{N0}$	[mm/(N/mm <sup>2</sup> )]					0,170				
	$\delta_{N\infty}$	[mm/(N/mm <sup>2</sup> )]					0,245				
120°C/72°C	$\delta_{N0}$	[mm/(N/mm <sup>2</sup> )]					0,170				
	$\delta_{N\infty}$	[mm/(N/mm <sup>2</sup> )]					0,245				

<sup>1)</sup> Calculation of the displacement

$$\delta_{N0} = \delta_{N0}\text{-factor} \cdot \tau;$$

$$\delta_{N\infty} = \delta_{N\infty}\text{-factor} \cdot \tau;$$

**Table C14: Displacements under shear load<sup>1)</sup> (threaded rod)**

Anchor size threaded rod			M 8	M 10	M 12	M 16	M 20	M24	M 27	M 30
For non-cracked concrete C20/25										
All temperatures	$\delta_{V0}$	[mm/(kN)]	0,06	0,06	0,05	0,04	0,04	0,03	0,03	0,03
	$\delta_{V\infty}$	[mm/(kN)]	0,09	0,08	0,08	0,06	0,06	0,05	0,05	0,05
For cracked concrete C20/25										
All temperatures	$\delta_{V0}$	[mm/(kN)]	No Performance Determined (NPD)		0,11	0,10	0,09	0,08	0,08	0,07
	$\delta_{V\infty}$	[mm/(kN)]			0,17	0,15	0,14	0,13	0,12	0,10

<sup>1)</sup> Calculation of the displacement

$$\delta_{V0} = \delta_{V0}\text{-factor} \cdot V;$$

$$\delta_{V\infty} = \delta_{V\infty}\text{-factor} \cdot V;$$

**Interfixings Injection system Easy-FIX for concrete**

**Performances**  
Displacements (threaded rods)

**Annex C13**

English translation prepared by DIBt

**Table C15: Displacements under tension load<sup>1)</sup> (rebar)**

Anchor size reinforcing bar			Ø 8	Ø 10	Ø 12	Ø 14	Ø 16	Ø 20	Ø 25	Ø 28	Ø 32	
<b>Non-cracked concrete C20/25</b>												
40°C/24°C	$\delta_{N0}$	[mm/(N/mm <sup>2</sup> )]	0,021	0,023	0,026	0,028	0,031	0,036	0,043	0,047	0,052	
	$\delta_{N\infty}$	[mm/(N/mm <sup>2</sup> )]	0,030	0,033	0,037	0,041	0,045	0,052	0,061	0,071	0,075	
80°C/50°C	$\delta_{N0}$	[mm/(N/mm <sup>2</sup> )]	0,050	0,056	0,063	0,069	0,075	0,088	0,104	0,113	0,126	
	$\delta_{N\infty}$	[mm/(N/mm <sup>2</sup> )]	0,072	0,081	0,090	0,099	0,108	0,127	0,149	0,163	0,181	
120°C/72°C	$\delta_{N0}$	[mm/(N/mm <sup>2</sup> )]	0,050	0,056	0,063	0,069	0,075	0,088	0,104	0,113	0,126	
	$\delta_{N\infty}$	[mm/(N/mm <sup>2</sup> )]	0,072	0,081	0,090	0,099	0,108	0,127	0,149	0,163	0,181	
<b>Cracked concrete C20/25</b>												
40°C/24°C	$\delta_{N0}$	[mm/(N/mm <sup>2</sup> )]	No Performance Determined (NPD)					0,070				
	$\delta_{N\infty}$	[mm/(N/mm <sup>2</sup> )]						0,105				
80°C/50°C	$\delta_{N0}$	[mm/(N/mm <sup>2</sup> )]						0,170				
	$\delta_{N\infty}$	[mm/(N/mm <sup>2</sup> )]						0,245				
120°C/72°C	$\delta_{N0}$	[mm/(N/mm <sup>2</sup> )]						0,170				
	$\delta_{N\infty}$	[mm/(N/mm <sup>2</sup> )]						0,245				

<sup>1)</sup> Calculation of the displacement

$$\delta_{N0} = \delta_{N0}\text{-factor} \cdot \tau;$$

$$\delta_{N\infty} = \delta_{N\infty}\text{-factor} \cdot \tau;$$

**Table C16: Displacement under shear load<sup>1)</sup> (rebar)**

Anchor size reinforcing bar			Ø 8	Ø 10	Ø 12	Ø 14	Ø 16	Ø 20	Ø 25	Ø 28	Ø 32	
For non-cracked concrete C20/25												
All temperatures	$\delta_{V0}$	[mm/(kN)]	0,06	0,05	0,05	0,04	0,04	0,04	0,03	0,03	0,03	
	$\delta_{V\infty}$	[mm/(kN)]	0,09	0,08	0,08	0,06	0,06	0,05	0,05	0,04	0,04	
For cracked concrete C20/25												
All temperatures	$\delta_{V0}$	[mm/(kN)]	No Performance Determined (NPD)			0,11	0,11	0,10	0,09	0,08	0,07	0,06
	$\delta_{V\infty}$	[mm/(kN)]				0,17	0,16	0,15	0,14	0,12	0,11	0,10

<sup>1)</sup> Calculation of the displacement

$$\delta_{V0} = \delta_{V0}\text{-factor} \cdot V;$$

$$\delta_{V\infty} = \delta_{V\infty}\text{-factor} \cdot V;$$

**Interfixings Injection system Easy-FIX for concrete**

**Performances**  
Displacements (rebar)

**Annex C14**