

Approval body for construction products
and types of construction

Bautechnisches Prüfamt

An institution established by the Federal and
Laender Governments



European Technical Assessment

ETA-99/0011
of 4 March 2015

English translation prepared by DIBt - Original version in German language

General Part

Technical Assessment Body issuing the
European Technical Assessment:

Deutsches Institut für Bautechnik

Trade name of the construction product

Würth Fixanchor W-FAZ and W-FAZ-IG

Product family
to which the construction product belongs

Torque controlled expansion anchor for use in concrete

Manufacturer

Adolf Würth GmbH & Co. KG
Reinhold-Würth-Straße 12 -17
74653 Künzelsau
DEUTSCHLAND

Manufacturing plant

Herstellwerk W1, Deutschland

This European Technical Assessment
contains

32 pages including 3 annexes which form an integral part
of this assessment

This European Technical Assessment is
issued in accordance with Regulation (EU)
No 305/2011, on the basis of

Guideline for European technical approval of "Metal
anchors for use in concrete", ETAG 001 Part 2: "Torque
controlled expansion anchors", April 2013,
used as European Assessment Document (EAD)
according to Article 66 Paragraph 3 of Regulation (EU)
No 305/2011.

European Technical Assessment
ETA-99/0011

Page 2 of 32 | 4 March 2015

English translation prepared by DIBt

The European Technical Assessment is issued by the Technical Assessment Body in its official language. Translations of this European Technical Assessment in other languages shall fully correspond to the original issued document and shall be identified as such.

Communication of this European Technical Assessment, including transmission by electronic means, shall be in full. However, partial reproduction may only be made with the written consent of the issuing Technical Assessment Body. Any partial reproduction has to be identified as such.

This European Technical Assessment may be withdrawn by the issuing Technical Assessment Body, in particular pursuant to information by the Commission according to Article 25 Paragraph 3 of Regulation (EU) No 305/2011.

Specific Part

1 Technical description of the product

The Würth Fixanchor W-FAZ and W-FAZ-IG is an anchor made of galvanised steel or made of stainless steel or high corrosion resistant steel which is placed into a drilled hole and anchored by torque-controlled expansion. The following anchor types are covered:

- Anchor type W-FAZ with external thread, washer and hexagon nut, sizes M8 to M27,
- Anchor type W-FAZ-IG S with internal thread, hexagon head nut and washer S-IG, sizes M6 to M12,
- Anchor type W-FAZ-IG SK with internal thread, countersunk head screw and countersunk washer SK-IG, sizes M6 to M12,
- Anchor type W-FAZ-IG B with internal thread, hexagon nut and washer B-IG, sizes M6 to M12.

The product description is given in Annex A.

2 Specification of the intended use in accordance with the applicable European Assessment Document

The performances given in Section 3 are only valid if the anchor is used in compliance with the specifications and conditions given in Annex B.

The verifications and assessment methods on which this European Technical Assessment is based lead to the assumption of a working life of the anchor of at least 50 years. The indications given on the working life cannot be interpreted as a guarantee given by the producer, but are to be regarded only as a means for choosing the right products in relation to the expected economically reasonable working life of the works.

3 Performance of the product and references to the methods used for its assessment

3.1 Mechanical resistance and stability (BWR 1)

Essential characteristic	Performance
Characteristic resistance for static and quasi static action for W-FAZ	See Annex C 1 to C 5
Characteristic resistance for seismic performance categories C1 and C2 for W-FAZ	See Annex C 6
Characteristic resistance for static and quasi static action for W-FAZ-IG	See Annex C 10 to C 12
Displacements under tension loads for W-FAZ	See Annex C 8
Displacements under shear loads for W-FAZ	See Annex C 9
Displacements under tension and shear loads for W-FAZ-IG	See Annex C 14

English translation prepared by DIBt

3.2 Safety in case of fire (BWR 2)

Essential characteristic	Performance
Reaction to fire	Anchorage satisfy requirements for Class A1
Resistance to fire for W-FAZ	See Annex C 7
Resistance to fire for W-FAZ-IG	See Annex C 13

3.3 Hygiene, health and the environment (BWR 3)

Not applicable.

3.4 Safety in use (BWR 4)

The essential characteristics regarding Safety in use are included under the Basic Works Requirement Mechanical resistance and stability.

3.5 Protection against noise (BWR 5)

Not applicable.

3.6 Energy economy and heat retention (BWR 6)

Not applicable.

3.7 Sustainable use of natural resources (BWR 7)

The sustainable use of natural resources was not investigated.

3.8 General aspects

The verification of durability is part of testing the essential characteristics. Durability is only ensured if the specifications of intended use according to Annex B are taken into account.

4 Assessment and verification of constancy of performance (AVCP) system applied, with reference to its legal base

According to Decision of the Commission of 24 June 1996 (96/582/EC) (OJ L 254 of 08.10.96 p. 62-65), the system of assessment and verification of constancy of performance (see Annex V and Article 65 Paragraph 2 to Regulation (EU) No 305/2011) given in the following table applies.

Product	Intended use	Level or class	System
Metal anchors for use in concrete (heavy-duty type)	For fixing and/or supporting concrete structural elements or heavy units such as cladding and suspended ceilings	—	1

English translation prepared by DIBt

5 Technical details necessary for the implementation of the AVCP system, as provided for in the applicable European Assessment Document

Technical details necessary for the implementation of the AVCP system are laid down in the control plan deposited at Deutsches Institut für Bautechnik.

Issued in Berlin on 04 March 2015 by Deutsches Institut für Bautechnik

Uwe Bender
Head of Department

beglaubigt:
Baderschneider

Fixanchor W-FAZ

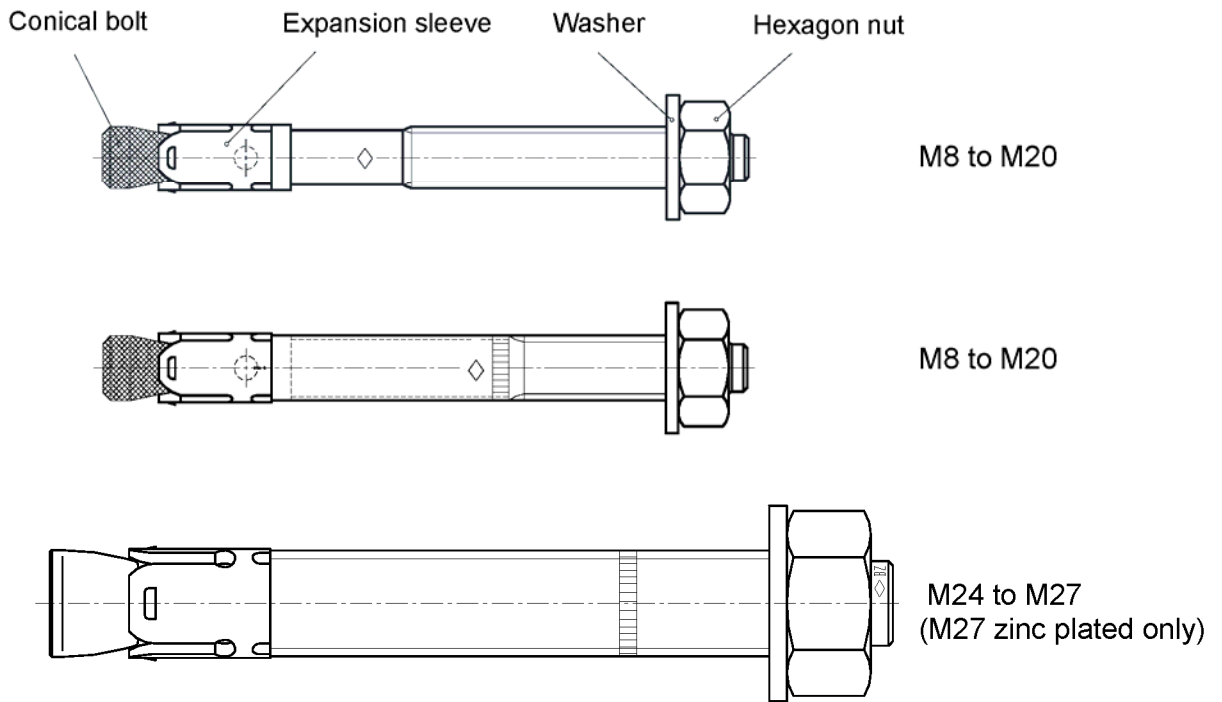

Fixanchor **W-FAZ-IG** M6 to M12

Anchor system

W-FAZ-IG S		Washer	Hexagon head screw
W-FAZ-IG SK	Conical bolt Expansion sleeve	Countersunk washer	Countersunk head screw
W-FAZ-IG B		Washer Hexagon nut	Commercial standard rod

Anchor version	Product description	Intended use	Performance
W-FAZ	Annex A1 – Annex A4	Annex B1 – Annex B4	Annex C1 – Annex C9
W-FAZ-IG	Annex A1 – Annex A2 Annex A5 – Annex A6	Annex B1 Annex B5 – Annex B7	Annex C10 – Annex C14

Würth Fixanchor W-FAZ and W-FAZ-IG

Product description
Anchor types

Annex A1

Intended use Fixanchor W-FAZ

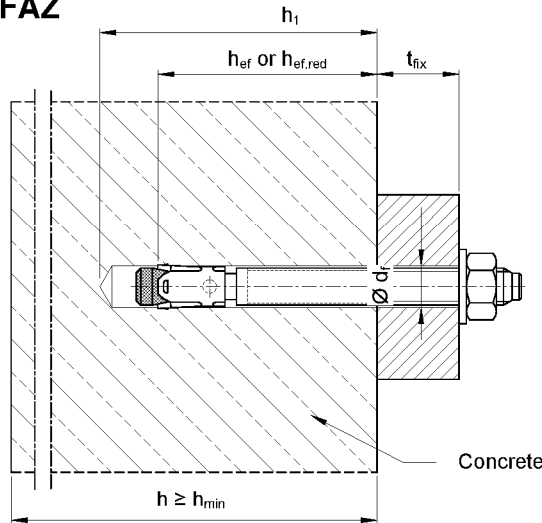

Intended use Wedge anchor W-FAZ-IG

**Installation type V
pre-setting installation**

pre-set anchor body, the fixture bears on the screw or thread rod only

**Installation type D
through-setting installation**

the anchor is set through the fixture, the fixture bears on the conical bolt W-FAZ-IG

W-FAZ-IG S consisting of W-FAZ-IG and S-IG

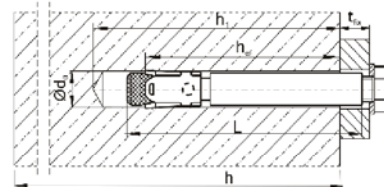
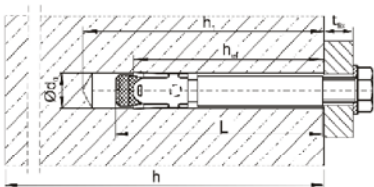

W-FAZ-IG SK consisting of W-FAZ-IG and SK-IG

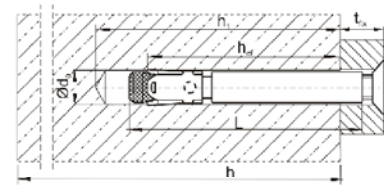
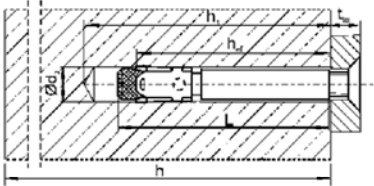

W-FAZ-IG B consisting of W-FAZ-IG and B-IG

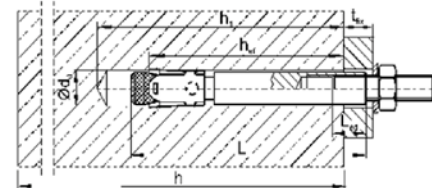
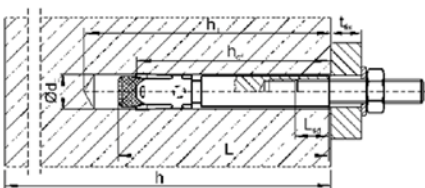

Würth Fixanchor W-FAZ and W-FAZ-IG

Product description
Installation situation

Annex A2

Anchor size W-FAZ M8 to M20:

Marking 1 e.g.: \diamond BZ 15/35

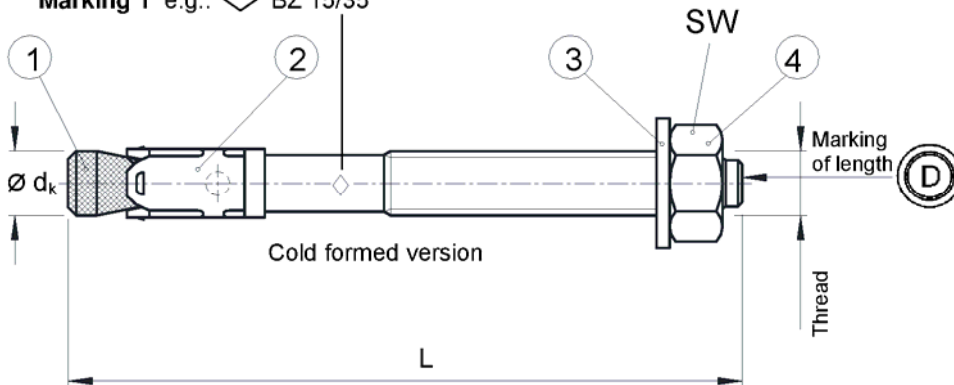

Marking 1: e.g.: \diamond BZ 15/35

- \diamond Identifying mark of manufacturing plant
- BZ Trade name
- 15 maximum thickness of fixture for h_{ef}
- 35 max. thickness of fixture for $h_{ef,red}$
- A4 additional marking of stainless steel A4
- HCR additional marking of high corrosion resistant steel HCR

Marking 2 e.g.: \diamond BZ 15

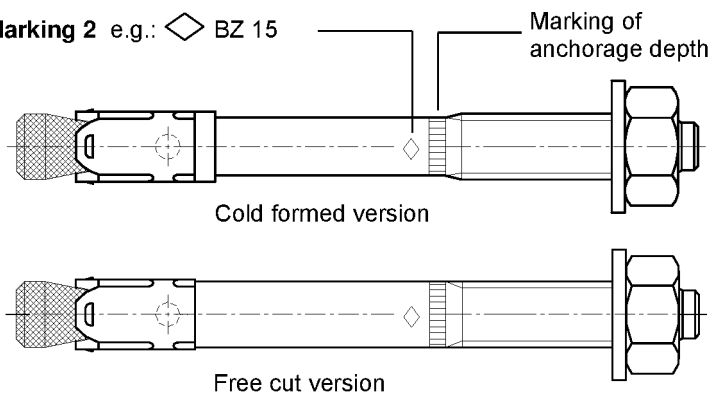

Marking 2: e.g.: \diamond BZ 15

- \diamond Identifying mark of manufacturing plant
- BZ Trade name
- 15 maximum thickness of fixture for h_{ef}
- A4 additional marking of stainless steel A4
- HCR additional marking of high corrosion resistant steel HCR

Anchor size W-FAZ M24 and M27:

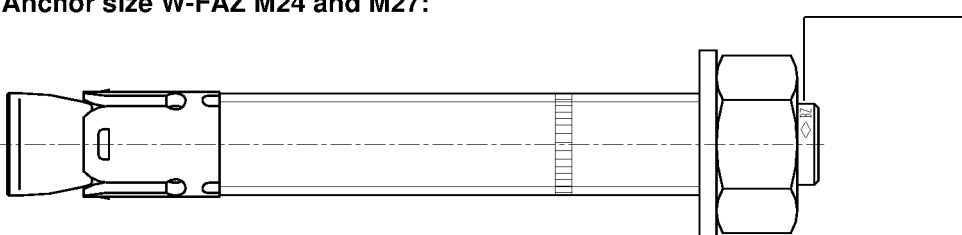

Marking 3: e.g.: \diamond BZ M24-30

- \diamond Identifying mark of manufacturing plant
- BZ Trade name
- M24 Thread diameter
- 30 maximum thickness of fixture
- A4 additional marking of stainless steel A4

Marking of length	C (c)	D (d)	E (e)	F (f)	G (g)	H (h)	I (i)	J (j)	K (k)	L (l)	M (m)	N (n)
Length of anchor min \geq	63.5	76.2	88.9	101.6	114.3	127.0	139.7	152.4	165.1	177.8	190.5	203.2
Length of anchor max $<$	76.2	88.9	101.6	114.3	127.0	139.7	152.4	165.1	177.8	190.5	203.2	215.9

Marking of length	O (o)	P (p)	Q (q)	R (r)	S (s)	T (t)	U (u)	V (v)	W (w)	X (x)	Y (y)	Z (z)
Length of anchor min \geq	215.9	228.6	241.3	254.0	279.4	304.8	330.2	355.6	381.0	406.4	431.8	457.2
Length of anchor max $<$	228.6	241.3	254.0	279.4	304.8	330.2	355.6	381.0	406.4	431.8	457.2	483.0

Würth Fixanchor W-FAZ

Product description
Anchor sizes and marking

Annex A3

Table A1: Anchor dimensions W-FAZ

Anchor size			M8	M10	M12	M16	M20	M24	M27	
1	Conical bolt	Thread	M8	M10	M12	M16	M20	M24	M27	
		$\varnothing d_k =$	7.9	9.8	12.0	15.7	19.7	24	28	
	Length of anchor	Steel, zinc plated	L	$65 + t_{fix}$	$80 + t_{fix}$	$96.5 + t_{fix}$	$118 + t_{fix}$	$137 + t_{fix}$	$161 + t_{fix}$	$178 + t_{fix}$
		A4, HCR	L	$65 + t_{fix}$	$80 + t_{fix}$	$96.5 + t_{fix}$	$118 + t_{fix}$	$137 + t_{fix}$	$168 + t_{fix}$	
	red. anchorage depth	$L_{hef,red}$	$54 + t_{fix}$	$60 + t_{fix}$	$76.5 + t_{fix}$	$98 + t_{fix}$				
2	Expansion sleeve		see Table A2							
3	Washer		see Table A2							
4	Hexagon nut	SW	13	17	19	24	30	36	41	

Dimensions in mm

Table A2: Materials W-FAZ

No.	Part	Steel, zinc plated M8 to M20	Steel, zinc plated M24 and M27	Stainless steel A4	High corrosion resistant steel (HCR)
1	Conical bolt	Cold formed or machined steel, Cone plastic coated (M8 to M20)	Threaded bolt and threaded cone, steel	Stainless steel 1.4401, 1.4404, 1.4571 or 1.4578, EN 10088:2005, Cone plastic coated	High corrosion resistant steel 1.4529 or 1.4565, EN 10088:2005, Cone plastic coated
2	Expansion sleeve	Steel acc. to EN 10088:2005, material No. 1.4301 or 1.4401	Steel acc. to EN 10139-12:1997	Stainless steel 1.4401 or 1.4571, EN 10088:2005	Stainless steel 1.4401 or 1.4571, EN 10088:2005
3	Washer	Steel, galvanised		Stainless steel 1.4401 or 1.4571, EN 10088:2005	High corrosion resistant steel 1.4529 or 1.4565, EN 10088:2005
4	Hexagon nut	Steel, galvanised, coated		stainless steel 1.4401 or 1.4571, EN 10088:2005, coated	high corrosion resistant steel 1.4529 or 1.4565, EN 10088:2005, coated

Würth Fixanchor W-FAZ

Product description
Dimensions and materials

Annex A4

Marking:  Identifying mark of manufacturing plant
 BZ Trade name
 M6 Size of internal thread
 10 max. thickness of fixture (only installation type D)
 A4 additionally for stainless steel
 HCR additionally for high corrosion resistant steel

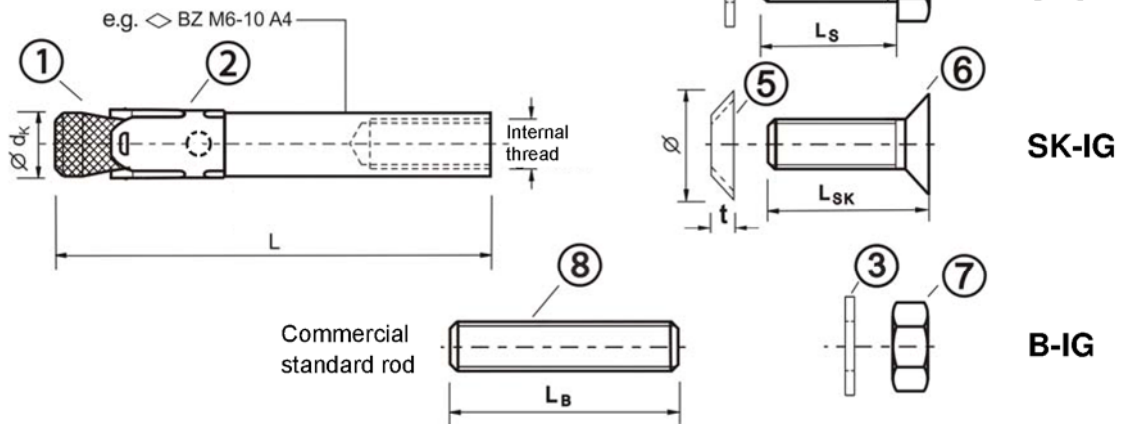

Table A3: Anchor dimensions W-FAZ-IG

No.	Anchor size		M6	M8	M10	M12	
1	Conical bolt with Internal thread Installation type V Installation type D	$\varnothing d_k$	7.9	9.8	11.8	15.7	
		L	50	62	70	86	
		L	$50 + t_{fix}$	$62 + t_{fix}$	$70 + t_{fix}$	$86 + t_{fix}$	
2	Expansion sleeve	see table A4					
3	Washer	see table A4					
4	Hexagon head screw Installation type V Installation type D	width across flats	10	13	17	19	
		L_s	$t_{fix} + (13 \text{ to } 21)$	$t_{fix} + (17 \text{ to } 23)$	$t_{fix} + (21 \text{ to } 25)$	$t_{fix} + (24 \text{ to } 29)$	
		L_s	14 to 20	18 to 22	20 to 22	25 to 28	
5	Countersunk washer	\varnothing countersink	17.3	21.5	25.9	30.9	
		t	3.9	5.0	5.7	6.7	
6	Countersunk head screw	bit size	Torx T30	Torx T45 (Steel, zinc plated) T40 (Stainless steel A4, HCR)	Hexagon socket 6 mm	Hexagon socket 8 mm	
		L_{sk}	$t_{fix} + (11 \text{ to } 19)$	$t_{fix} + (15 \text{ to } 21)$	$t_{fix} + (19 \text{ to } 23)$	$t_{fix} + (21 \text{ to } 27)$	
		L_{sk}	16 to 20	20 to 25	25	30	
7	Hexagon nut	width across flats	10	13	17	19	
8	Commercial standard rod ¹⁾	type V	$L_B \geq$	$t_{fix} + 21$	$t_{fix} + 28$	$t_{fix} + 34$	$t_{fix} + 41$
		type D	$L_B \geq$	21	28	34	41

¹⁾ acc. to specifications (Table A4)

Dimensions in mm

Würth Fixanchor W-FAZ-IG

Product description
Anchor parts, marking and dimensions

Annex A5

Table A4: Materials W-FAZ-IG

No.	Part	Steel, zinc plated ≥ 5 µm acc. to EN ISO 4042:1999	Stainless steel A4	High corrosion resistant steel HCR
1	Conical bolt W-FAZ-IG with internal thread	Machined steel, Cone plastic coated	Stainless steel, 1.4401, 1.4404, 1.4571, 1.4362, EN 10088:2005, Cone plastic coated	High corrosion resistant steel, 1.4529, 1.4565, EN 10088:2005, Cone plastic coated
2	Expansion sleeve W-FAZ-IG	Stainless steel, 1.4301, 1.4401, EN 10088:2005	Stainless steel, 1.4401, 1.4571, EN 10088:2005	Stainless steel, 1.4401, 1.4571, EN 10088:2005
3	Washer S-IG / B-IG	Steel, galvanised	Stainless steel, 1.4401, 1.4571, EN 10088:2005	High corrosion resistant steel, 1.4529, 1.4565, EN 10088:2005
4	Hexagon head screw S-IG	Steel, galvanised, coated	Stainless steel, 1.4401, 1.4571, EN 10088:2005, coated	High corrosion resistant steel, 1.4529, 1.4565, EN 10088:2005, coated
5	Countersunk washer SK-IG	Steel, galvanised	Stainless steel, 1.4401, 1.4404, 1.4571, EN 10088:2005, zinc plated, coated	High corrosion resistant steel, 1.4529, 1.4565, EN 10088:2005, zinc plated, coated
6	Countersunk head screw SK-IG	Steel, galvanised coated	Stainless steel, 1.4401, 1.4571, EN 10088:2005, coated	High corrosion resistant steel, 1.4529, 1.4565, EN 10088:2005, coated
7	Hexagon nut B-IG	Steel, galvanised coated	Stainless steel, 1.4401, 1.4571, EN 10088: 2005, coated	High corrosion resistant steel, 1.4529, 1.4565, EN 10088:2005, coated
8	Commercial standard rod	Property class 8.8, EN ISO 898-1:2013 A ₅ > 8 % ductile	Stainless steel, 1.4401, 1.4571, EN 10088:2005, property class 70, EN ISO 3506:2009	High corrosion resistant steel, 1.4529, 1.4565, EN 10088:2005, property class 70, EN ISO 3506:2009

Würth Fixanchor W-FAZ-IG

Product description
Materials

Annex A6

Specifications of intended use

Fixanchor W-FAZ	M8	M10	M12	M16	M20	M24	M27
Static or quasi-static action				✓			
Seismic action (Categorie C1 + C2) ^{1) 2)}		✓	✓	✓	✓		
Reduced anchorage depth ²⁾	✓	✓	✓	✓			
Fire exposure ¹⁾				✓			
Cracked and non-cracked				✓			

Fixanchor W-FAZ-IG	M6	M8	M10	M12
Static or quasi-static action		✓		
Seismic action				
Fire exposure		✓		
Cracked and non-cracked		✓		

¹⁾ only for standard anchorage depth

²⁾ only cold formed anchors acc. to Annex A3

Base materials:

- Reinforced or unreinforced normal weight concrete according to EN 206-1: 2000
- Strength classes C20/25 to C50/60 according to EN 206-1: 2000

Use conditions (Environmental conditions):

- Structures subject to dry internal conditions (zinc plated steel, stainless steel or high corrosion resistant steel).
- Structures subject to external atmospheric exposure including industrial and marine environment or exposure to permanently damp internal condition, if no particular aggressive conditions exist (stainless steel or high corrosion resistant steel).
- Structures subject to external atmospheric exposure and to permanently damp internal condition, if other particular aggressive conditions (high corrosion resistant steel)

Note: Particular aggressive conditions are e.g. permanent, alternating immersion in seawater or the splash zone of seawater, chloride atmosphere of indoor pools or atmosphere with extreme chemical pollution (e.g. in desulphurization plants or road tunnels where de-icing materials are used.)

Design:

- Anchorages are designed under the responsibility of an engineer experienced in anchorages and concrete work.
- Verifiable calculation notes and drawings are prepared taking account of the loads to be anchored. The position of the anchor is indicated on the design drawings (e.g. position of the anchor relative to reinforcement or to supports, etc.).
- Anchorages under static or quasi-static actions are designed in accordance with:
 - ETAG 001, Annex C, design method A, Edition August 2010 or
 - CEN/TS 1992-4: 2009, design method A
- Anchorages under seismic actions (cracked concrete) are designed in accordance with:
 - EOTA Technical Report TR 045, Edition February 2013
 - Anchorages shall be positioned outside of critical regions (e.g. plastic hinges) of the concrete structure
 - Fastenings in stand-off installation or with a grout layer are not allowed
- Anchorages under fire exposure are designed in accordance with:
 - ETAG 001, Annex C, design method A, Edition August 2010 and EOTA Technical Report TR 020, Edition May 2004 or
 - CEN/TS 1992-4: 2009, Annex D
(It must be ensured that local spalling of the concrete cover does not occur)

Würth Fixanchor W-FAZ and W-FAZ-IG

Intended use
Specifications

Annex B1

Table B1: Installation parameters W-FAZ

Anchor size			M8	M10	M12	M16	M20	M24	M27	
Nominal drill hole diameter	d_0	[mm]	8	10	12	16	20	24	28	
Cutting diameter of drill bit	$d_{cut} \leq$	[mm]	8.45	10.45	12.5	16.5	20.55	24.55	28.55	
Installation torque	Steel, zinc plated	T_{inst}	20	25	45	90	160	200	300	
	A4, HCR	T_{inst}	20	35	50	110	200	290		
Diameter of clearance hole in the fixture	$d_f \leq$	[mm]	9	12	14	18	22	26	30	
Standard anchorage depth										
Depth of drill hole	Steel, zinc plated	$h_1 \geq$	[mm]	60	75	90	110	125	145	160
	A4, HCR	$h_1 \geq$	[mm]	60	75	90	110	125	155	
Effective anchorage depth	Steel, zinc plated	h_{ef}	[mm]	46	60	70	85	100	115	125
	A4, HCR	h_{ef}	[mm]	46	60	70	85	100	125	
Reduced anchorage depth										
Depth of drill hole	$h_{1,red} \geq$	[mm]	49	55	70	90				
Reduced effective anchorage depth	$h_{ef,red}$	[mm]	35	40	50	65				

Table B2: Minimum spacings and edge distances, reduced anchorage depth, W-FAZ

Anchor size			M8	M10	M12	M16
Minimum thickness of concrete member	$h_{min,3}$	[mm]	80	80	100	140
Cracked concrete						
Minimum spacing	s_{min}	[mm]	50	50	50	65
	for $c \geq$	[mm]	60	100	160	170
Minimum edge distance	c_{min}	[mm]	40	65	65	100
	for $s \geq$	[mm]	185	180	250	250
Non-cracked concrete						
Minimum spacing	s_{min}	[mm]	50	50	50	65
	for $c \geq$	[mm]	60	100	160	170
Minimum edge distance	c_{min}	[mm]	40	65	100	170
	for $s \geq$	[mm]	185	180	185	65

Würth Fixanchor W-FAZ

Intended use
Installation parameters,
Minimum spacings and edge distances for reduced anchorage depth

Annex B2

Table B3: Minimum spacings and edge distances, standard anchorage depth, W-FAZ

Anchor size			M8	M10	M12	M16	M20	M24	M27
Standard thickness of concrete member									
Steel zinc plated									
Standard thickness of member	$h_{min,1}$	[mm]	100	120	140	170	200	230	250
Cracked concrete									
Minimum spacing	s_{min}	[mm]	40	45	60	60	95	100	125
	for $c \geq$	[mm]	70	70	100	100	150	180	300
Minimum edge distance	c_{min}	[mm]	40	45	60	60	95	100	180
	for $s \geq$	[mm]	80	90	140	180	200	220	540
Non-cracked concrete									
Minimum spacing	s_{min}	[mm]	40	45	60	65	90	100	125
	for $c \geq$	[mm]	80	70	120	120	180	180	300
Minimum edge distance	c_{min}	[mm]	50	50	75	80	130	100	180
	for $s \geq$	[mm]	100	100	150	150	240	220	540
Stainless steel A4, HCR									
Standard thickness of member	$h_{min,1}$	[mm]	100	120	140	160	200	250	
Cracked concrete									
Minimum spacing	s_{min}	[mm]	40	50	60	60	95	125	
	for $c \geq$	[mm]	70	75	100	100	150	125	
Minimum edge distance	c_{min}	[mm]	40	55	60	60	95	125	
	for $s \geq$	[mm]	80	90	140	180	200	125	
Non-cracked concrete									
Minimum spacing	s_{min}	[mm]	40	50	60	65	90	125	
	for $c \geq$	[mm]	80	75	120	120	180	125	
Minimum edge distance	c_{min}	[mm]	50	60	75	80	130	125	
	for $s \geq$	[mm]	100	120	150	150	240	125	
Minimum thickness of concrete member									
Steel zinc plated and stainless steel A4, HCR									
Minimum thickness of member	$h_{min,2}$	[mm]	80	100	120	140			
Cracked concrete									
Minimum spacing	s_{min}	[mm]	40	45	60	70			
	for $c \geq$	[mm]	70	90	100	160			
Minimum edge distance	c_{min}	[mm]	40	50	60	80			
	for $s \geq$	[mm]	80	115	140	180			
Non-cracked concrete									
Minimum spacing	s_{min}	[mm]	40	60	60	80			
	for $c \geq$	[mm]	80	140	120	180			
Minimum edge distance	c_{min}	[mm]	50	90	75	90			
	for $s \geq$	[mm]	100	140	150	200			
Fire exposure from one side									
Minimum spacing	$s_{min,fi}$	[mm]	See normal ambient temperature						
Minimum edge distance	$c_{min,fi}$	[mm]	See normal ambient temperature						
Fire exposure from more than one side									
Minimum spacing	$s_{min,fi}$	[mm]	See normal ambient temperature						
Minimum edge distance	$c_{min,fi}$	[mm]	≥ 300 mm						

Intermediate values by linear interpolation.

Würth Fixanchor W-FAZ

Intended use
Minimum spacings and edge distances for standard anchorage depth

Annex B3

Installation instructions W-FAZ

The fitness for use of the anchor can only be assumed if the anchor is installed as follows:

- Anchor installation carried out by appropriately qualified personnel and under the supervision of the person responsible for technical matters of the site,
- Use of the anchor only as supplied by the manufacturer without exchanging the components of the anchor.
- Checks before placing the anchor to ensure that the strength class of the concrete in which the anchor is to be placed is in the range given and is not lower than that of the concrete to which the characteristic loads apply
- Check of concrete being well compacted, e.g. without significant voids,
- Edge distances and spacing not less than the specified values without minus tolerances.

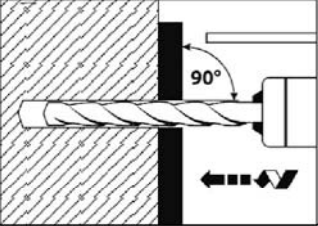
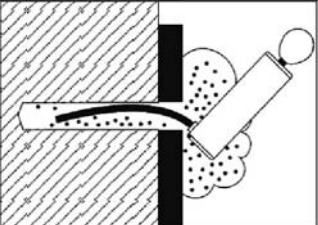
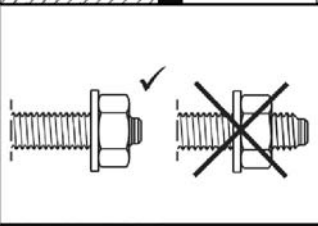
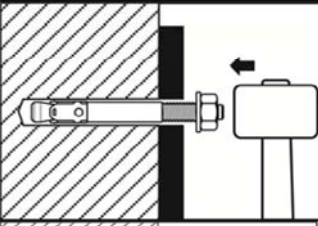
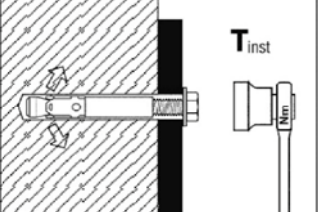
1		<p>Drill hole perpendicular to concrete surface, positioning without damaging the reinforcement.</p> <p>In case of aborted hole: new drilling at a minimum distance away of twice the depth of the aborted hole or smaller distance if the aborted drill hole is filled with high strength mortar and if under shear or oblique tension load it is not in the direction of load application.</p>
2		<p>Blow out dust. Alternatively vacuum clean down to the bottom of the hole.</p>
3		<p>Check position of nut.</p>
4		<p>Drive in anchor, such that h_{ef} or $h_{ef,red}$ depth is met. This compliance is ensured, if the thickness of fixture is not greater than the maximum thickness of fixture marked on the anchor in accordance with Annex A3.</p>
5		<p>Max. tightening torque T_{inst} shall be applied by using calibrated torque wrench.</p>

Würth Fixanchor W-FAZ

Intended Use
Installation instructions

Annex B4

Table B4: Installation parameters W-FAZ-IG

Anchor size			M6	M8	M10	M12
Effective anchorage depth	h_{ef}	[mm]	45	58	65	80
Drill hole diameter	d_0	[mm]	8	10	12	16
Cutting diameter of drill bit	$d_{cut} \leq$	[mm]	8.45	10.45	12.5	16.5
Depth of drill hole	$h_1 \geq$	[mm]	60	75	90	105
Screwing depth of threaded rod	$L_{sd}^{2)} \geq$	[mm]	9	12	15	18
Installation moment, zinc plated steel	S	[Nm]	10	30	30	55
	SK	[Nm]	10	25	40	50
	B	[Nm]	8	25	30	45
Installation moment, stainless steel A4, HCR	S	[Nm]	15	40	50	100
	SK	[Nm]	12	25	45	60
	B	[Nm]	8	25	40	80
Installation type V (Pre-setting installation)						
Diameter of clearance hole in the fixture	$d_f \leq$	[mm]	7	9	12	14
Minimum thickness of fixture	S	[mm]	1	1	1	1
	SK	[mm]	5	7	8	9
	B	[mm]	1	1	1	1
Installation type D (Through-setting installation)						
Diameter of clearance hole in the fixture	$d_f \leq$	[mm]	9	12	14	18
Minimum thickness of fixture ¹⁾	S	[mm]	5	7	8	9
	SK	[mm]	9	12	14	16
	B	[mm]	5	7	8	9

¹⁾ The minimum thickness of fixture can be reduced to the value of installation type V, if the shear load at steel failure is designed with lever arm.

²⁾ see Annex A2

Table B5: Minimum spacings and edge distances W-FAZ-IG

Anchor size			M6	M8	M10	M12
Minimum thickness of concrete member	h_{min}	[mm]	100	120	130	160
Cracked concrete						
Minimum spacing	s_{min}	[mm]	50	60	70	80
	for $c \geq$	[mm]	60	80	100	120
Minimum edge distance	c_{min}	[mm]	50	60	70	80
	for $s \geq$	[mm]	75	100	100	120
Non-cracked concrete						
Minimum spacing	s_{min}	[mm]	50	60	65	80
	for $c \geq$	[mm]	80	100	120	160
Minimum edge distance	c_{min}	[mm]	50	60	70	100
	for $s \geq$	[mm]	115	155	170	210
Fire exposure from one side						
Minimum spacing	$s_{min,fi}$	[mm]	See normal temperature			
Minimum edge distance	$c_{min,fi}$	[mm]	See normal temperature			
Fire exposure from more than one side						
Minimum spacing	$s_{min,fi}$	[mm]	See normal temperature			
Minimum edge distance	$c_{min,fi}$	[mm]	≥ 300 mm			

Würth Fixanchor W-FAZ-IG

Intended use
Installation parameters, minimum spacings and edge distances

Annex B5

Installation instructions **W-FAZ-IG**

The fitness for use of the anchor can only be assumed if the anchor is installed as follows:

- Anchor installation carried out by appropriately qualified personnel and under the supervision of the person responsible for technical matters of the site,
- Use of the anchor only as supplied by the manufacturer without exchanging the components of an anchor.
- Checks before placing the anchor to ensure that the strength class of the concrete in which the anchor is to be placed is in the range given and is not lower than that of the concrete to which the characteristic loads apply
- Check of concrete being well compacted, e.g. without significant voids,
- Edge distances and spacing not less than the specified values without minus tolerances.

Pre-setting installation

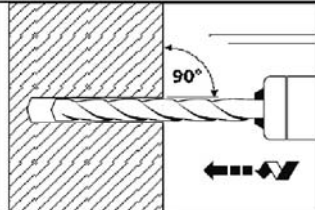
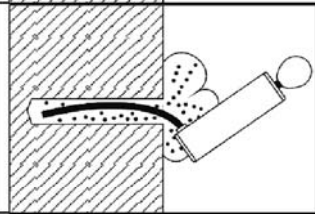
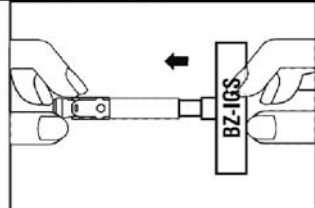
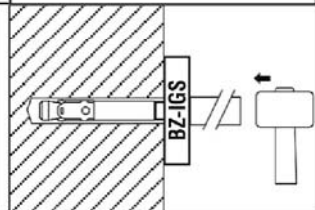
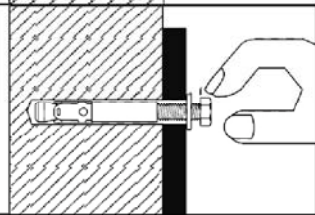
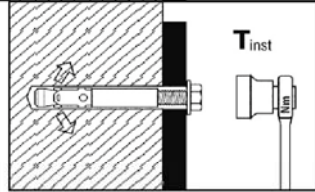
1		Drill hole perpendicular to concrete surface, positioning without damaging the reinforcement. In case of aborted hole: new drilling at a minimum distance away twice the depth of the aborted hole or smaller distance if the aborted drill hole is filled with high strength mortar and if under shear or oblique tension load it is not in the direction of load application.
2		Blow out dust. Alternatively vacuum clean down to the bottom of the hole.
3		Setting tool for pre-setting installation insert in anchor.
4		Drive in anchor with setting tool.
5		Drive in screw.
6		Max. tightening torque T_{inst} may be applied by using calibrated torque wrench.

Würth Fixanchor W-FAZ-IG

Intended Use
Installation instructions for pre-setting installation

Annex B6

Installation instructions **W-FAZ-IG**

Through-setting installation

1		<p>Drill hole perpendicular to concrete surface, positioning without damaging the reinforcement.</p> <p>In case of aborted hole: new drilling at a minimum distance away of twice the depth of the aborted hole or smaller distance if the aborted drill hole is filled with high strength mortar and if under shear or oblique tension load it is not in the direction of load application.</p>
2		<p>Blow out dust. Alternatively vacuum clean down to the bottom of the hole.</p>
3		<p>Setting tool for through-setting installation insert in anchor.</p> 
4		<p>Drive in anchor with setting tool.</p>
5		<p>Drive in screw.</p>
6		<p>Max. tightening torque T_{inst} may be applied by using calibrated torque wrench.</p>

Würth Fixanchor W-FAZ-IG

Intended Use
Installation instructions for through-setting installation

Annex B7

Table C1: Characteristic values for tension loads, W-FAZ zinc plated, cracked concrete, static and quasi-static action

Anchor size		M8	M10	M12	M16	M20	M24	M27
Installation safety factor	$\gamma_2 = \gamma_{inst}$ [-]	1.0						
Steel failure								
Characteristic tension resistance	$N_{Rk,s}$ [kN]	16	27	40	60	86	126	196
Partial safety factor	γ_{Ms} [-]	1.53		1.5		1.6	1.5	
Pull-out								
Standard anchorage depth								
Characteristic resistance in concrete C20/25	$N_{Rk,p}$ [kN]	5	9	16	25	1)	1)	1)
Reduced anchorage depth								
Characteristic resistance in concrete C20/25	$N_{Rk,p,red}$ [kN]	5	7.5	1)	1)	/	/	/
Increasing factor for $N_{Rk,p}$ and $N_{Rk,p,red}$	ψ_c [-]	$\left(\frac{f_{ck,cube}}{25}\right)^{0.5}$						
Concrete cone failure								
Effective anchorage depth	h_{ef} [mm]	46	60	70	85	100	115	125
Reduced anchorage depth	$h_{ef,red}$ [mm]	35 ²⁾	40	50	65	/	/	/
Factor according to CEN/TS 1992-4	k_{cr} [-]	7.2						

¹⁾ Pull-out is not decisive.

²⁾ Use restricted to anchoring of structural components statically indeterminate.

Würth Fixanchor W-FAZ

Performance
Characteristic values for **tension loads, W-FAZ zinc plated cracked concrete**, static and quasi-static action

Annex C1

Table C2: Characteristic values for tension loads, W-FAZ A4 / HCR, cracked concrete, static and quasi-static action

Anchor size			M8	M10	M12	M16	M20	M24
Installation safety factor	$\gamma_2 = \gamma_{inst}$	[-]	1.0					
Steel failure								
Characteristic tension resistance	$N_{Rk,s}$	[kN]	16	27	40	64	108	110
Partial safety factor	γ_{Ms}	[-]	1.5				1.68	1.5
Pull-out								
Standard anchorage depth								
Characteristic resistance in concrete C20/25	$N_{Rk,p}$	[kN]	5	9	16	25	1)	40
Reduced anchorage depth								
Characteristic resistance in concrete C20/25	$N_{Rk,p,red}$	[kN]	5	7.5	1)	1)	/	/
Increasing factor for $N_{Rk,p}$ and $N_{Rk,p,red}$	ψ_c	[-]	$\left(\frac{f_{ck,cube}}{25}\right)^{0.5}$					
Concrete cone failure								
Effective anchorage depth	h_{ef}	[mm]	46	60	70	85	100	125
Reduced anchorage depth	$h_{ef,red}$	[mm]	35 ²⁾	40	50	65	/	/
Factor according to CEN/TS 1992-4	k_{cr}	[-]	7.2					

1) Pull-out is not decisive.

2) Use restricted to anchoring of structural components statically indeterminate.

Würth Fixanchor W-FAZ

Performance
Characteristic values for **tension loads, W-FAZ A4 / HCR, cracked concrete**, static and quasi-static action

Annex C2

Table C3: Characteristic values for tension loads, W-FAZ zinc plated, non-cracked concrete, static and quasi-static action

Anchor size		M8	M10	M12	M16	M20	M24	M27
Installation safety factor	$\gamma_2 = \gamma_{inst}$ [-]	1.0						
Steel failure								
Characteristic tension resistance	$N_{RK,s}$ [kN]	16	27	40	60	86	126	196
Partial safety factor	γ_{Ms} [-]	1.53		1.5		1.6	1.5	
Pull-out								
Standard anchorage depth								
Characteristic resistance in non-cracked concrete C20/25	$N_{RK,p}$ [kN]	12	16	25	35	1)	1)	1)
Reduced anchorage depth								
Characteristic resistance in non-cracked concrete C20/25	$N_{RK,p,red}$ [kN]	7.5	9	1)	1)			
Splitting For the proof against splitting failure $N_{RK,c}^0$ has to be replaced by $N_{RK,sp}^0$ with consideration of the member thickness								
Standard anchorage depth								
Splitting for standard thickness of concrete member (The higher resistance of case 1 and case 2 may be applied; the values $s_{cr,sp}$ and $c_{cr,sp}$ may be linearly interpolated for the member thickness $h_{min} < h < h_{std}$ (Case 2); $\psi_{h,sp} = 1,0$)								
Standard thickness of concrete	$h_{min,1} \geq$ [mm]	100	120	140	170	200	230	250
Case 1								
Characteristic resistance in non-cracked concrete C20/25	$N_{RK,sp}^0$ [kN]	9	12	20	30	40	1)	50
Spacing (edge distance)	$s_{cr,sp} (= 2 c_{cr,sp})$ [mm]	3 h_{ef}						
Case 2								
Characteristic resistance in non-cracked concrete C20/25	$N_{RK,sp}^0$ [kN]	12	16	25	35	1)	1)	1)
Spacing (edge distance)	$s_{cr,sp} (= 2 c_{cr,sp})$ [mm]	4 h_{ef}				4.4 h_{ef}	3 h_{ef}	5 h_{ef}
Splitting for minimum thickness of concrete member								
Minimum thickness of concrete	$h_{min,2} \geq$ [mm]	80	100	120	140			
Characteristic resistance in non-cracked concrete C20/25	$N_{RK,sp}^0$ [kN]	12	16	25	35			
Spacing (edge distance)	$s_{cr,sp} (= 2 c_{cr,sp})$ [mm]	5 h_{ef}						
Reduced anchorage depth								
Minimum thickness of concrete	$h_{min,3} \geq$ [mm]	80	80	100	140			
Characteristic resistance in non-cracked concrete C20/25	$N_{RK,sp}^0$ [kN]	7.5	9	1)	1)			
Spacing (edge distance)	$s_{cr,sp} (= 2 c_{cr,sp})$ [mm]	200	200	250	300			
Increasing factor for $N_{RK,p(red)}$ and $N_{RK,sp}^0$	ψ_c [-]	$\left(\frac{f_{ck,cube}}{25}\right)^{0,5}$						
Concrete cone failure								
Effective anchorage depth	h_{ef} [mm]	46	60	70	85	100	115	125
Reduced anchorage depth	$h_{ef,red}$ [mm]	35 ²⁾	40	50	65			
Factor according to CEN/TS 1992-4	k_{ucr} [-]	10.1						

¹⁾ Pull-out is not decisive.

²⁾ Use restricted to anchoring of structural components statically indeterminate.

Würth Fixanchor W-FAZ

Performance
Characteristic values for tension loads, W-FAZ zinc plated, non-cracked concrete, static and quasi-static action

Annex C3

Table C4: Characteristic values for tension loads, W-FAZ A4 / HCR, non-cracked concrete, static and quasi-static action

Anchor size			M8	M10	M12	M16	M20	M24
Installation safety factor	$\gamma_2 = \gamma_{inst}$	[-]	1.0					
Steel failure								
Characteristic tension resistance	$N_{Rk,s}$	[kN]	16	27	40	64	108	110
Partial safety factor	γ_{Ms}	[-]	1.5				1.68	1.5
Pull-out								
Standard anchorage depth								
Characteristic resistance in non-cracked concrete C20/25	$N_{Rk,p}$	[kN]	12	16	25	35	1)	1)
Reduced anchorage depth								
Characteristic resistance in non-cracked concrete C20/25	$N_{Rk,p,red}$	[kN]	7.5	9	1)	1)		
Splitting For the proof against splitting failure $N_{Rk,c}^0$ has to be replaced by $N_{Rk,sp}^0$ with consideration of the member thickness								
Standard anchorage depth								
Splitting for standard thickness of concrete member (The higher resistance of case 1 and case 2 may be applied; the values $s_{cr,sp}$ and $c_{cr,sp}$ may be linearly interpolated for the member thickness $h_{min} < h < h_{std}$ (Case 2); $\psi_{h,sp} = 1,0$)								
Standard thickness of concrete	$h_{min,1} \geq$	[mm]	100	120	140	160	200	250
Case 1								
Characteristic resistance in non-cracked concrete C20/25	$N_{Rk,sp}^0$	[kN]	9	12	20	30	40	
Spacing (edge distance)	$s_{cr,sp} (= 2 c_{cr,sp})$	[mm]	3 h_{ef}					
Case 2								
Characteristic resistance in non-cracked concrete C20/25	$N_{Rk,sp}^0$	[kN]	12	16	25	35	1)	1)
Spacing (edge distance)	$s_{cr,sp} (= 2 c_{cr,sp})$	[mm]	230	250	280	400	440	500
Splitting for minimum thickness of concrete member								
Minimum thickness of concrete	$h_{min,2} \geq$	[mm]	80	100	120	140		
Characteristic resistance in non-cracked concrete C20/25	$N_{Rk,sp}^0$	[kN]	12	16	25	35		
Spacing (edge distance)	$s_{cr,sp} (= 2 c_{cr,sp})$	[mm]	5 h_{ef}					
Reduced anchorage depth								
Minimum thickness of concrete	$h_{min,3} \geq$	[mm]	80	80	100	140		
Characteristic resistance in non-cracked concrete C20/25	$N_{Rk,sp}^0$	[kN]	7.5	9	1)	1)		
Spacing (edge distance)	$s_{cr,sp} (= 2 c_{cr,sp})$	[mm]	200	200	250	300		
Increasing factor for $N_{Rk,p(red)}$ and $N_{Rk,sp}^0$	ψ_c	[-]	$\left(\frac{f_{ck,cube}}{25}\right)^{0,5}$					
Concrete cone failure								
Effective anchorage depth	h_{ef}	[mm]	46	60	70	85	100	125
Reduced anchorage depth	$h_{ef,red}$	[mm]	35 ²⁾	40	50	65		
Factor according to CEN/TS 1992-4	k_{ucr}	[-]	10.1					

¹⁾ Pull-out is not decisive.

²⁾ Use restricted to anchoring of structural components statically indeterminate.

Würth Fixanchor W-FAZ

Performance
Characteristic values for tension loads, W-FAZ A4 / HCR, non-cracked concrete, static and quasi-static action

Annex C4

Table C5: Characteristic values for shear loads, W-FAZ, cracked and non-cracked concrete, static or quasi static action

Anchor size			M8	M10	M12	M16	M20	M24	M27	
Installation safety factor	$\gamma_2 = \gamma_{inst}$	[-]	1.0							
Steel failure without lever arm, Steel zinc plated										
Characteristic shear resistance	$V_{Rk,s}$	[kN]	12.2	20.1	30	55	69	114	169.4	
Factor for ductility	k_2	[-]	1.0							
Partial safety factor	γ_{Ms}	[-]	1.25				1.33	1.25	1.25	
Steel failure without lever arm, Stainless steel A4, HCR										
Characteristic shear resistance	$V_{Rk,s}$	[kN]	13	20	30	55	86	123.6	/	
Factor for ductility	k_2	[-]	1.0							
Partial safety factor	γ_{Ms}	[-]	1.25				1.4	1.25		
Steel failure with lever arm, Steel zinc plated										
Characteristic bending resistance	$M^0_{Rk,s}$	[Nm]	23	47	82	216	363	898	1331.5	
Partial safety factor	γ_{Ms}	[-]	1.25				1.33	1.25	1.25	
Steel failure with lever arm, Stainless steel A4, HCR										
Characteristic bending resistance	$M^0_{Rk,s}$	[Nm]	26	52	92	200	454	785.4	/	
Partial safety factor	γ_{Ms}	[-]	1.25				1.4	1.25		
Concrete pry-out failure										
Factor k acc. ETAG 001, Annex C or k ₃ acc. CEN/TS 1992-4	$k_{(3)}$	[-]	2.4				2.8			
Concrete edge failure										
Effective length of anchor in shear loading with h_{ef}	Steel zinc plated	l_f	[mm]	46	60	70	85	100	115	125
	Stainless steel A4, HCR	l_f	[mm]	46	60	70	85	100	125	/
Effective length of anchor in shear loading with $h_{ef,red}$	Steel zinc plated	$l_{f,red}$	[mm]	35	40	50	65	/	/	
	Stainless steel A4, HCR	$l_{f,red}$	[mm]	35	40	50	65			
Outside diameter of anchor	d_{nom}	[mm]	8	10	12	16	20	24	27	

Würth Fixanchor W-FAZ

Performance
Characteristic values for **shear loads, W-FAZ, cracked and non-cracked concrete, static or quasi static action**

Annex C5

Table C6: Characteristic resistance for **seismic loading, W-FAZ, standard anchorage depth, performance category C1 and C2**

Tension loads							
Anchor size			M10	M12	M16	M20	
Installation safety factor		$\gamma_2 = \gamma_{inst}$	[-]	1.0			
Steel failure, steel zinc plated							
Characteristic resistance C1		$N_{Rk,s,seis,C1}$	[kN]	27	40	60	86
Characteristic resistance C2		$N_{Rk,s,seis,C2}$	[kN]	27	40	60	86
Partial safety factor		$\gamma_{Ms,seis}$	[-]	1.53	1.5		1.6
Steel failure, stainless steel A4, HCR							
Characteristic resistance C1		$N_{Rk,s,seis,C1}$	[kN]	27	40	64	108
Characteristic resistance C2		$N_{Rk,s,seis,C2}$	[kN]	27	40	64	108
Partial safety factor		$\gamma_{Ms,seis}$	[-]	1.5		1.68	
Pull-out							
Characteristic resistance C1		$N_{Rk,p,seis,C1}$	[kN]	9	16	25	36
Characteristic resistance C2		$N_{Rk,p,seis,C2}$	[kN]	3.6	10.2	13.8	22.4
Shear loads							
Steel failure without lever arm, Steel zinc plated							
Characteristic resistance C1		$V_{Rk,s,seis,C1}$	[kN]	20	27	44	69
Characteristic resistance C2		$V_{Rk,s,seis,C2}$	[kN]	14	16.2	35.7	55.2
Partial safety factor		$\gamma_{Ms,seis}$	[-]	1.25			1.33
Steel failure without lever arm, Stainless steel A4, HCR							
Characteristic resistance C1		$V_{Rk,s,seis,C1}$	[kN]	20	27	44	69
Characteristic resistance C2		$V_{Rk,s,seis,C2}$	[kN]	14	16.2	35.7	55.2
Partial safety factor		$\gamma_{Ms,seis}$	[-]	1.25			1.4

Würth Fixanchor W-FAZ

Performance
Characteristic resistance for **seismic loading, W-FAZ, standard anchorage depth, performance category C1 and C2**

Annex C6

Table C7: Characteristic values for tension and shear load under fire exposure, W-FAZ, standard anchorage depth, cracked and non-cracked concrete C20/25 to C50/60

Anchor size		M8	M10	M12	M16	M20	M24	M27		
Tension load										
Steel failure										
Steel zinc plated										
Characteristic resistance	R30	$N_{Rk,s,fi}$	[kN]	1.4	2.2	3.2	6.0	9.4	13.6	17.6
	R60			1.1	1.8	2.8	5.2	8.2	11.8	15.3
	R90			0.8	1.4	2.4	4.4	6.9	10.0	13.0
	R120			0.7	1.2	2.2	4.0	6.3	9.1	11.8
Stainless steel A4, HCR										
Characteristic resistance	R30	$N_{Rk,s,fi}$	[kN]	3.8	6.9	11.5	21.5	33.5	48.2	
	R60			2.9	5.2	8.6	16	25.0	35.9	
	R90			2.0	3.5	5.6	10.5	16.4	23.6	
	R120			1.6	2.7	4.2	7.8	12.1	17.4	
Shear load										
Steel failure without lever arm										
Steel zinc plated										
Characteristic resistance	R30	$V_{Rk,s,fi}$	[kN]	1.6	2.6	3.8	7.0	11	16	20.6
	R60			1.5	2.5	3.6	6.8	11	15	19.8
	R90			1.2	2.1	3.5	6.5	10	15	19.0
	R120			1.0	2.0	3.4	6.4	10	14	18.6
Stainless steel A4, HCR										
Characteristic resistance	R30	$V_{Rk,s,fi}$	[kN]	3.8	6.9	11.5	21.5	33.5	48.2	
	R60			2.9	5.2	8.6	16	25.0	35.9	
	R90			2.0	3.5	5.6	10.5	16.4	23.6	
	R120			1.6	2.7	4.2	7.8	12.1	17.4	
Steel failure with lever arm										
Steel zinc plated										
Characteristic resistance	R30	$M^0_{Rk,s,fi}$	[Nm]	1.7	3.3	5.9	15	29	50	75
	R60			1.6	3.2	5.6	14	28	48	72
	R90			1.2	2.7	5.4	14	27	47	69
	R120			1.1	2.5	5.3	13	26	46	68
Stainless steel A4, HCR										
Characteristic resistance	R30	$M^0_{Rk,s,fi}$	[Nm]	3.8	9.0	17.9	45.5	88.8	153.5	
	R60			2.9	6.8	13.3	33.9	66.1	114.3	
	R90			2.1	4.5	8.8	22.2	43.4	75.1	
	R120			1.6	3.4	6.5	16.4	32.1	55.5	

The characteristic resistance for pull-out failure, concrete cone failure, concrete pry-out and concrete edge failure can be calculated according to TR020 / CEN/TS 1992-4. If pull-out is not decisive $N_{Rk,p}$ in Eq. 2.4 and Eq. 2.5, TR 020 must be replaced by $N^0_{Rk,c}$.

Würth Fixanchor W-FAZ

Performance

Characteristic values for tension and shear load under fire exposure, W-FAZ, standard anchorage depth, cracked and non-cracked concrete C20/25 to C50/60

Annex C7

Table C8: Displacements under tension load, W-FAZ

Anchor size			M8	M10	M12	M16	M20	M24	M27
Standard anchorage depth									
Steel zinc plated									
Tension load in cracked concrete	N	[kN]	2.4	4.3	7.6	11.9	17.1	21.1	24
Displacement	δ_{N0}	[mm]	0.6	1.0	0.4	1.0	0.9	0.7	0.9
	$\delta_{N\infty}$	[mm]	1.4	1.2	1.4	1.3	1.0	1.2	1.4
Tension load in non-cracked concrete	N	[kN]	5.7	7.6	11.9	16.7	23.8	29.6	34
Displacement	δ_{N0}	[mm]	0.4	0.5	0.7	0.3	0.4	0.5	0.3
	$\delta_{N\infty}$	[mm]	0.8		1.4	0.8		1.4	
Displacements under seismic tension loads C2									
Displacements for DLS	$\delta_{N,seis,C2(DLS)}$	[mm]	/	4.1	4.9	3.6	5.1	/	/
Displacements for ULS	$\delta_{N,seis,C2(ULS)}$	[mm]	/	13.8	15.7	9.5	15.2	/	/
Stainless steel A4, HCR									
Tension load in cracked concrete	N	[kN]	2.4	4.3	7.6	11.9	17.1	19.0	/
Displacement	δ_{N0}	[mm]	0.7	1.8	0.4	0.7	0.9	0.5	/
	$\delta_{N\infty}$	[mm]	1.2	1.4	1.4	1.4	1.0	1.8	/
Tension load in non-cracked concrete	N	[kN]	5.8	7.6	11.9	16.7	23.8	33.5	/
Displacement	δ_{N0}	[mm]	0.6	0.5	0.7	0.2	0.4	0.5	/
	$\delta_{N\infty}$	[mm]	1.2	1.0	1.4	0.4	0.8	1.1	/
Displacements under seismic tension loads C2									
Displacements for DLS	$\delta_{N,seis,C2(DLS)}$	[mm]	/	4.1	4.9	3.6	5.1	/	/
Displacements for ULS	$\delta_{N,seis,C2(ULS)}$	[mm]	/	13.8	15.7	9.5	15.2	/	/
Reduced anchorage depth									
Tension load in cracked concrete	N	[kN]	2.4	3.6	6.1	9.0	/	/	/
Displacement	δ_{N0}	[mm]	0.8	0.7	0.5	1.0	/	/	/
	$\delta_{N\infty}$	[mm]	1.2	1.0	0.8	1.1	/	/	/
Tension load in non-cracked concrete	N	[kN]	3.7	4.3	8.5	12.6	/	/	/
Displacement	δ_{N0}	[mm]	0.1	0.2	0.2	0.2	/	/	/
	$\delta_{N\infty}$	[mm]	0.7	0.7	0.7	0.7	/	/	/

Würth Fixanchor W-FAZ

Performance
Displacements under tension load

Annex C8

Table C9: Displacements under shear load, W-FAZ

Anchor size			M8	M10	M12	M16	M20	M24	M27
Standard anchorage depth									
Steel zinc plated									
Shear load in cracked and non-cracked concrete	V	[kN]	6.9	11.4	17.1	31.4	36.8	64.9	96.8
Displacement	δ_{V0}	[mm]	2.0	3.2	3.6	3.5	1.8	3.5	3.6
	$\delta_{V\infty}$	[mm]	3.0	4.7	5.5	5.3	2.7	5.3	5.4
Displacements under seismic shear loads C2									
Displacements for DLS	$\delta_{V,seis,C2(DLS)}$	[mm]	/	2.7	3.5	4.3	4.7	/	/
Displacements for ULS	$\delta_{V,seis,C2(ULS)}$	[mm]	/	5.3	9.5	9.6	10.1	/	/
Stainless steel A4, HCR									
Shear load in cracked and non-cracked concrete	V	[kN]	7.3	11.4	17.1	31.4	43.8	70.6	/
Displacement	δ_{V0}	[mm]	1.9	2.4	4.0	4.3	2.9	2.8	/
	$\delta_{V\infty}$	[mm]	2.9	3.6	5.9	6.4	4.3	4.2	/
Displacements under seismic shear loads C2									
Displacements for DLS	$\delta_{V,seis,C2(DLS)}$	[mm]	/	2.7	3.5	4.3	4.7	/	/
Displacements for ULS	$\delta_{V,seis,C2(ULS)}$	[mm]	/	5.3	9.5	9.6	10.1	/	/
Reduced anchorage depth									
Steel zinc plated									
Shear load in cracked and non-cracked concrete	V	[kN]	6.9	11.4	17.1	31.4	/	/	/
Displacement	δ_{V0}	[mm]	2.0	3.2	3.6	3.5	/	/	/
	$\delta_{V\infty}$	[mm]	3.0	4.7	5.5	5.3	/	/	/
Stainless steel A4, HCR									
Shear load in cracked and non-cracked concrete	V	[kN]	7.3	11.4	17.1	31.4	/	/	/
Displacement	δ_{V0}	[mm]	1.9	2.4	4.0	4.3	/	/	/
	$\delta_{V\infty}$	[mm]	2.9	3.6	5.9	6.4	/	/	/

Würth Fixanchor W-FAZ

Performance
Displacements under shear load

Annex C9

Table C10: Characteristic values for **tension loads, W-FAZ-IG, cracked concrete**, static and quasi-static action

Anchor size			M6	M8	M10	M12
Installation safety factor	$\gamma_2 = \gamma_{inst}$	[-]	1.2			
Steel failure						
Characteristic tension resistance, steel zinc plated	$N_{Rk,s}$	[kN]	16.1	22.6	26.0	56.6
Partial safety factor	γ_{Ms}	[-]	1.5			
Characteristic tension resistance, stainless steel A4, HCR	$N_{Rk,s}$	[kN]	14.1	25.6	35.8	59.0
Partial safety factor	γ_{Ms}	[-]	1.87			
Pull-out failure						
Characteristic resistance in cracked concrete C20/25	$N_{Rk,p}$	[kN]	5	9	12	20
Increasing factor	ψ_c	[-]	$\left(\frac{f_{ck,cube}}{25}\right)^{0.5}$			
Concrete cone failure						
Effective anchorage depth	h_{ef}	[mm]	45	58	65	80
Factor according to CEN/TS 1992-4	k_{cr}	[-]	7.2			

Würth Fixanchor W-FAZ-IG

Performance
Characteristic values for **tension loads, W-FAZ-IG, cracked concrete**, static and quasi-static action

Annex C10

Table C11: Characteristic values for tension loads, **W-FAZ-IG,
non-cracked concrete, static and quasi-static action**

Anchor size			M6	M8	M10	M12
Installation safety factor	$\gamma_2 = \gamma_{inst}$	[-]	1.2			
Steel failure						
Characteristic tension resistance, steel zinc plated	$N_{Rk,s}$	[kN]	16.1	22.6	26.0	56.6
Partial safety factor	γ_{Ms}	[-]	1.5			
Characteristic tension resistance, stainless steel A4, HCR	$N_{Rk,s}$	[kN]	14.1	25.6	35.8	59.0
Partial safety factor	γ_{Ms}	[-]	1.87			
Pull-out						
Characteristic resistance in non-cracked concrete C20/25	$N_{Rk,p}$	[kN]	12	16	20	30
Splitting ($N_{Rk,c}^0$ has to be replaced by $N_{Rk,sp}^0$. The higher resistance of Case 1 and Case 2 may be applied.)						
Minimum thickness of concrete member	h_{min}	[mm]	100	120	130	160
Case 1						
Characteristic resistance in non-cracked concrete C20/25	$N_{Rk,sp}^0$	[kN]	9	12	16	25
Spacing (edge distance)	$s_{cr,sp} (= 2 c_{cr,sp})$	[mm]	$3 h_{ef}$			
Case 2						
Characteristic resistance in non-cracked concrete C20/25	$N_{Rk,sp}^0$	[kN]	12	16	20	30
Spacing (edge distance)	$s_{cr,sp} (= 2 c_{cr,sp})$	[mm]	$5 h_{ef}$			
Increasing factor for $N_{Rk,p}$ and $N_{Rk,sp}^0$	ψ_c	[-]	$\left(\frac{f_{ck,cube}}{25}\right)^{0.5}$			
Concrete cone failure						
Effective anchorage depth	h_{ef}	[mm]	45	58	65	80
Factor according to CEN/TS 1992-4	k_{ucr}	[-]	10.1			

Würth Fixanchor W-FAZ-IG

Performance
Characteristic values for tension loads, **W-FAZ-IG**,
non-cracked concrete, static and quasi-static action

Annex C11

Table C12: Characteristic values for shear loads, **W-FAZ-IG,
cracked and non-cracked concrete, static and quasi-static action**

Anchor size			M6	M8	M10	M12
Installation safety factor	$\gamma_2 = \gamma_{inst}$	[-]	1.0			
W-FAZ-IG, steel zinc plated						
Steel failure without lever arm, Installation type V						
Characteristic shear resistance	$V_{Rk,s}$	[kN]	5.8	6.9	10.4	25.8
Steel failure without lever arm, Installation type D						
Characteristic shear resistance	$V_{Rk,s}$	[kN]	5.1	7.6	10.8	24.3
Steel failure with lever arm, Installation type V						
Characteristic bending resistance	$M^0_{Rk,s}$	[Nm]	12.2	30.0	59.8	104.6
Steel failure with lever arm, Installation type D						
Characteristic bending resistance	$M^0_{Rk,s}$	[Nm]	36.0	53.2	76.0	207
Partial safety factor for $V_{Rk,s}$ and $M^0_{Rk,s}$	γ_{Ms}	[-]	1.25			
Factor of ductility	k_2	[-]	1.0			
W-FAZ-IG, stainless steel A4, HCR						
Steel failure without lever arm, Installation type V						
Characteristic shear resistance	$V_{Rk,s}$	[kN]	5.7	9.2	10.6	23.6
Partial safety factor	γ_{Ms}	[-]	1.25			
Steel failure without lever arm, Installation type D						
Characteristic shear resistance	$V_{Rk,s}$	[kN]	7.3	7.6	9.7	29.6
Partial safety factor	γ_{Ms}	[-]	1.25			
Steel failure with lever arm, Installation type V						
Characteristic bending resistance	$M^0_{Rk,s}$	[Nm]	10.7	26.2	52.3	91.6
Partial safety factor	γ_{Ms}	[-]	1.56			
Steel failure with lever arm, Installation type D						
Characteristic bending resistance	$M^0_{Rk,s}$	[Nm]	28.2	44.3	69.9	191.2
Partial safety factor	γ_{Ms}	[-]	1.25			
Factor of ductility	k_2	[-]	1.0			
Concrete pry-out failure						
Factor k acc. ETAG 001, Annex C or k_3 acc. CEN/TS 1992-4	$k_{(3)}$	[-]	1.5	1.5	2.0	2.0
Concrete edge failure						
Effective length of anchor in shear loading	l_f	[mm]	45	58	65	80
Effective diameter of anchor	d_{nom}	[mm]	8	10	12	16

Würth Fixanchor W-FAZ-IG

Performance
Characteristic values for shear loads, **W-FAZ-IG**,
cracked and non-cracked concrete, static and quasi-static action

Annex C12

Table C13: Characteristic values for tension and shear load under fire exposure, W-FAZ-IG
cracked and non-cracked concrete C20/25 to C50/60

Anchor size		M6	M8	M10	M12		
Tension load							
Steel failure							
Steel zinc plated							
Characteristic resistance	R30	$N_{Rk,s,fi}$	[kN]	0.7	1.4	2.5	3.7
	R60			0.6	1.2	2.0	2.9
	R90			0.5	0.9	1.5	2.2
	R120			0.4	0.8	1.3	1.8
Stainless steel A4, HCR							
Characteristic resistance	R30	$N_{Rk,s,fi}$	[kN]	2.9	5.4	8.7	12.6
	R60			1.9	3.8	6.3	9.2
	R90			1.0	2.1	3.9	5.7
	R120			0.5	1.3	2.7	4.0
Shear load							
Steel failure without lever arm							
Steel zinc plated							
Characteristic resistance	R30	$V_{Rk,s,fi}$	[kN]	0.7	1.4	2.5	3.7
	R60			0.6	1.2	2.0	2.9
	R90			0.5	0.9	1.5	2.2
	R120			0.4	0.8	1.3	1.8
Stainless steel A4, HCR							
Characteristic resistance	R30	$V_{Rk,s,fi}$	[kN]	2.9	5.4	8.7	12.6
	R60			1.9	3.8	6.3	9.2
	R90			1.0	2.1	3.9	5.7
	R120			0.5	1.3	2.7	4.0
Steel failure with lever arm							
Steel zinc plated							
Characteristic resistance	R30	$M^0_{Rk,s,fi}$	[Nm]	0.5	1.4	3.3	5.7
	R60			0.4	1.2	2.6	4.6
	R90			0.4	0.9	2.0	3.4
	R120			0.3	0.8	1.6	2.8
Stainless steel A4, HCR							
Characteristic resistance	R30	$M^0_{Rk,s,fi}$	[Nm]	2.2	5.5	11.2	19.6
	R60			1.5	3.9	8.1	14.3
	R90			0.7	2.2	5.1	8.9
	R120			0.4	1.3	3.5	6.2

The characteristic resistance for pull-out failure, concrete cone failure, concrete pry-out failure and concrete edge failure can be designed according to TR020 / CEN/TS 1992-4.

Würth Fixanchor W-FAZ-IG

Performance

Characteristic values for tension and shear loads under fire exposure, **W-FAZ-IG**
cracked and non-cracked concrete C20/25 to C50/60

Annex C13

Table C14: Displacements under tension load, W-FAZ-IG

Anchor size		M6	M8	M10	M12
Tension load in cracked concrete	N [kN]	2.0	3.6	4.8	8.0
Displacements	δ_{N0} [mm]	0.6	0.6	0.8	1.0
	$\delta_{N\infty}$ [mm]	0.8	0.8	1.2	1.4
Tension load in non-cracked concrete	N [kN]	4.8	6.4	8.0	12.0
Displacements	δ_{N0} [mm]	0.4	0.5	0.7	0.8
	$\delta_{N\infty}$ [mm]	0.8	0.8	1.2	1.4

Table C15: Displacements under shear load, W-FAZ-IG

Anchor size		M6	M8	M10	M12
Shear load in cracked and non-cracked concrete	V [kN]	4.2	5.3	6.2	16.9
Displacements	δ_{V0} [mm]	2.8	2.9	2.5	3.6
	$\delta_{V\infty}$ [mm]	4.2	4.4	3.8	5.3

Würth Fixanchor W-FAZ-IG

Performance
Displacements under tension load and under shear load

Annex C14