

Approval body for construction products
and types of construction

Bautechnisches Prüfamt

An institution established by the Federal and
Laender Governments



European Technical Assessment

ETA-05/0139
of 1 March 2016

English translation prepared by DIBt - Original version in German language

General Part

Technical Assessment Body issuing the
European Technical Assessment:

Deutsches Institut für Bautechnik

Trade name of the construction product

TOX Drop-in anchor E / ES

Product family
to which the construction product belongs

Deformation-controlled expansion anchor for use in
non-cracked concrete

Manufacturer

TOX-Dübel-Technik GmbH
Brunnenstraße 31
72505 Krauchenwies-Ablach
DEUTSCHLAND

Manufacturing plant

TOX Werk 10, Deutschland

This European Technical Assessment
contains

16 pages including 3 annexes which form an integral part
of this assessment

This European Technical Assessment is
issued in accordance with Regulation (EU)
No 305/2011, on the basis of

Guideline for European technical approval of "Metal
anchors for use in concrete", ETAG 001 Part 4:
"Deformation controlled expansion anchors", April 2013,
used as European Assessment Document (EAD)
according to Article 66 Paragraph 3 of Regulation (EU)
No 305/2011.

This version replaces

ETA-05/0139 issued on 4 March 2015

**European Technical Assessment
ETA-05/0139**

Page 2 of 16 | 1 March 2016

English translation prepared by DIBt

The European Technical Assessment is issued by the Technical Assessment Body in its official language. Translations of this European Technical Assessment in other languages shall fully correspond to the original issued document and shall be identified as such.

Communication of this European Technical Assessment, including transmission by electronic means, shall be in full. However, partial reproduction may only be made with the written consent of the issuing Technical Assessment Body. Any partial reproduction shall be identified as such.

This European Technical Assessment may be withdrawn by the issuing Technical Assessment Body, in particular pursuant to information by the Commission in accordance with Article 25(3) of Regulation (EU) No 305/2011.

Specific Part

1 Technical description of the product

The TOX Drop-in Anchor E / ES is an anchor made of galvanised steel, made of stainless steel or high corrosion resistant steel which is placed into a drilled hole and anchored by deformation-controlled expansion.

The product description is given in Annex A.

2 Specification of the intended use in accordance with the applicable European Assessment Document

The performances given in Section 3 are only valid if the anchor is used in compliance with the specifications and conditions given in Annex B.

The verifications and assessment methods on which this European Technical Assessment is based lead to the assumption of a working life of the anchor of at least 50 years. The indications given on the working life cannot be interpreted as a guarantee given by the producer, but are to be regarded only as a means for choosing the right products in relation to the expected economically reasonable working life of the works.

3 Performance of the product and references to the methods used for its assessment

3.1 Mechanical resistance and stability (BWR 1)

Essential characteristic	Performance
Characteristic resistance for tension and shear loads as well as bending moments in concrete	See Annex C 1 to C 4
Edge distances and spacing	See Annex C 1 to C 2
Displacements under tension and shear loads	See Annex C 5

3.2 Safety in case of fire (BWR 2)

Essential characteristic	Performance
Reaction to fire	Anchorage satisfy requirements for Class A1
Resistance to fire	No performance assessed

3.3 Safety in use (BWR 4)

The essential characteristics regarding Safety in use are included under the Basic Works Requirement Mechanical resistance and stability.

4 Assessment and verification of constancy of performance (AVCP) system applied, with reference to its legal base

In accordance with guideline for European technical approval ETAG 001, April 2013, used as European Assessment Document (EAD) according to Article 66 Paragraph 3 of Regulation (EU) No 305/2011, the applicable European legal act is: [96/582/EC].

The system to be applied is: 1

English translation prepared by DIBt

5 Technical details necessary for the implementation of the AVCP system, as provided for in the applicable European Assessment Document

Technical details necessary for the implementation of the AVCP system are laid down in the control plan deposited with Deutsches Institut für Bautechnik.

Issued in Berlin on 1 March 2016 by Deutsches Institut für Bautechnik

Andreas Kummerow
p.p. Head of Department

beglaubigt:
Baderschneider

Drop-in Anchor E / ES

Anchor size

E M6x30



ES M6x30



E M8x30



ES M8x30



E M8x40



ES M8x40



ES M10x30
(zinc plated only)

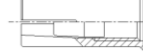

E M10x40



ES M10x40



E M12x50



ES M12x50



E M12x80



ES M12x80



E M16x65



ES M16x65



E M16x80



ES M16x80



E M20x80



TOX Drop-in Anchor E / ES

Product description
Anchor size

Annex A1

Installation situation

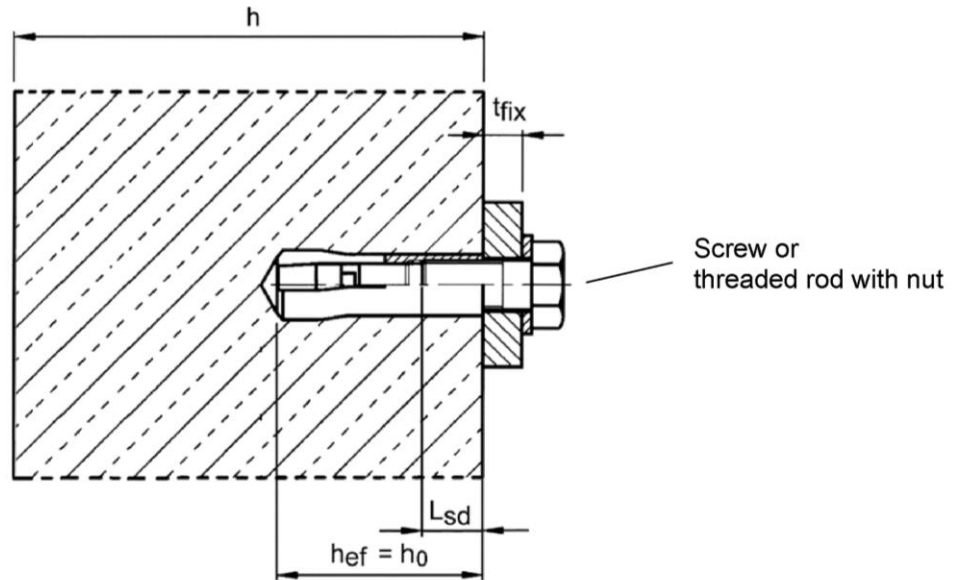

Table A1: Designations of anchor parts and material

Part	Designation	Steel, zinc plated	Stainless steel A4	High corrosion resistant steel HCR
1	Anchor sleeve	Cold formed or machining steel, zinc plated, EN ISO 4042:1999	Stainless steel, 1.4401, 1.4404, 1.4571, 1.4362, EN 10088:2005, Property class 70, acc. to EN ISO 3506:2010	Stainless steel, 1.4529, 1.4565, EN 10088:2005, Property class 70, acc. to EN ISO 3506:2010
2	Cone	Steel for cold forming acc. to EN 10263-2:2001	Stainless steel, 1.4401, 1.4404, 1.4571, 1.4362, EN 10088:2005	

TOX Drop-in Anchor E / ES

Product description
Installation situation and material

Annex A2

Anchor sleeve

Anchor version without shoulder (E)

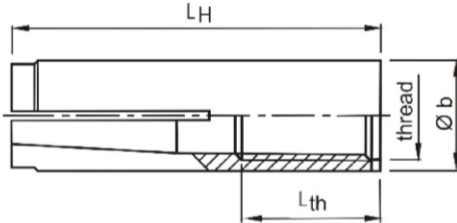

Marking: see Table A2

e.g.: \diamond E M8x40

\diamond Identifying mark of manufacturing plant
E Anchor identity (version without shoulder)
ES Anchor identity (version with shoulder)
M8 Size of thread
40 Anchorage depth

Anchor version with shoulder (ES)

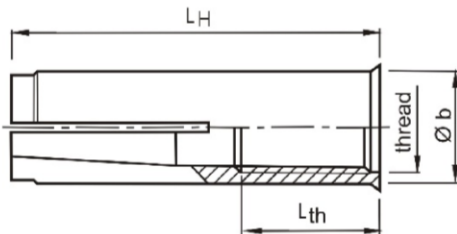

A4 additional marking
of stainless steel A4

HCR additional marking of
high corrosion resistant steel

Cone

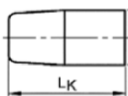

Size M6x30 and M10x30

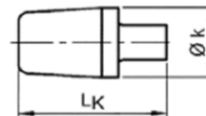

Size M8x30 – M20x80

Table A2: Dimensions and marking

Anchor size	Anchor sleeve				Cone		Marking		
	thread	Ø b	L _H	L _{th}	Ø k	L _K	version E	version ES	alternatively
M6x30	M6	8	30	13	5,0	13	\diamond E M6x30	\diamond ES M6x30	\diamond E M6
M8x30	M8	10	30	13			6,5	12	\diamond E M8x30
M8x40	M8	10	40	20	-				\diamond E M8x40
M10x30	M10	12	30	12	8,2	12	-	\diamond ES M10x30	\diamond E M10x30
M10x40	M10	12	40	15			8,2	16	\diamond E M10x40
M12x50	M12	15	50	18	10,3	20			\diamond E M12x50
M12x80	M12	15	80	45			13,8	29	\diamond E M12x80
M16x65	M16	19,7	65	23	13,8	29			\diamond E M16x65
M16x80	M16	19,7	80	38			\diamond E M16x80	\diamond ES M16x80	\diamond E M16x80
M20x80	M20	24,7	80	34	16,5	30	\diamond E M20x80	-	\diamond E M20

Dimensions in mm

TOX Drop-in Anchor E / ES

Product description
Dimensions and marking

Annex A3

Setting tool for marking

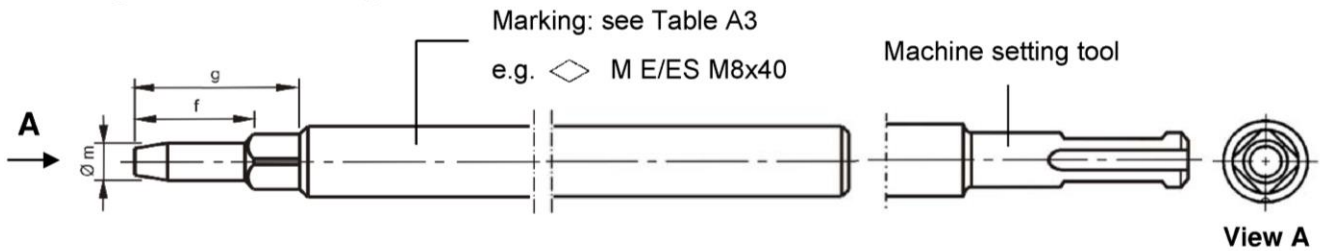

Verification of correct installation with setting tool for marking
The setting tool leaves a visible marking after correct installation.

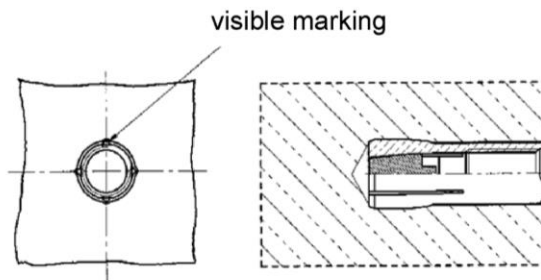

Setting tool

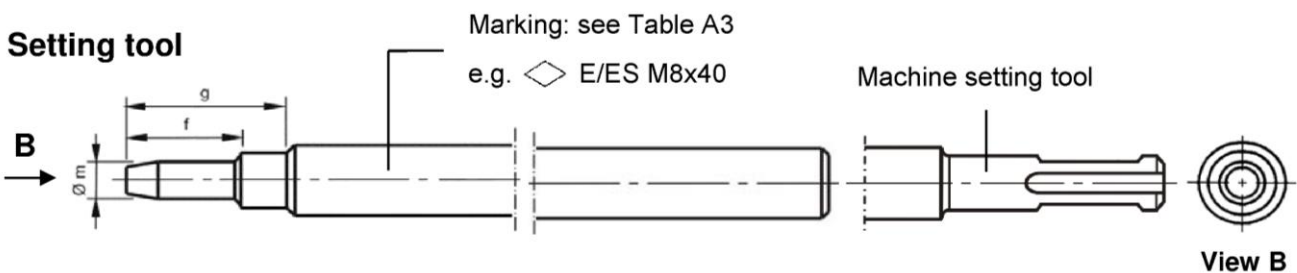

Table A3: Dimensions and marking of setting tools

Anchor size	Ø m	f	g	Setting tool for marking		Setting tool	
					alternatively		alternatively
M6x30	4,9	17	27	◇ M E/ES M6x30	◇ M E M6	◇ E/ES M6x30	◇ E M6
M8x30	6,4	18	28	◇ M E/ES M8x30	◇ M E M8	◇ E/ES M8x30	◇ E M8
M8x40	6,4	28	38	◇ M E/ES M8x40	◇ M E M8x40	◇ E/ES M8x40	◇ E M8x40
M10x30	8,0	18	28	◇ M ES M10x30	◇ M E M10x30	◇ ES M10x30	◇ E M10x30
M10x40	8,0	24	34	◇ M E/ES M10x40	◇ M E M10	◇ E/ES M10x40	◇ E M10
M12x50	10,0	30	40	◇ M E/ES M12x50	◇ M E M12	◇ E/ES M12x50	◇ E M12
M12x80	10,0	60	70	◇ M E/ES M12x80	◇ M E M12x80	◇ E/ES M12x80	◇ E M12x80
M16x65	13,5	36	46	◇ M E/ES M16x65	◇ M E M16	◇ E/ES M16x65	◇ E M16
M16x80	13,5	51	61	◇ M E/ES M16x80	◇ M E M16x80	◇ E/ES M16x80	◇ E M16x80
M20x80	16,5	50	60	◇ M E M20x80	◇ M E M20	◇ E M20x80	◇ E M20

Dimensions in mm

TOX Drop-in Anchor E / ES

Product description
Setting tools, dimensions and marking

Annex A4

Specifications of intended use

Anchorage subject to:

- Static and quasi-static loads

Base materials:

- Reinforced or unreinforced normal weight concrete according to EN 206-1:2000
- Non-cracked concrete
- Strength classes C20/25 to C50/60 according to EN 206-1:2000

Use conditions:

- Structures subject to dry internal conditions (zinc plated steel, stainless steel or high corrosion resistant steel).
- Structures subject to external atmospheric exposure including industrial and marine environment or exposure to permanently damp internal condition, if no particular aggressive conditions exist (stainless steel or high corrosion resistant steel).
- Structures subject to external atmospheric exposure and to permanently damp internal condition, if other particular aggressive conditions (high corrosion resistant steel).

Note: Particular aggressive conditions are e.g. permanent, alternating immersion in seawater or the splash zone of seawater, chloride atmosphere of indoor pools or atmosphere with extreme chemical pollution (e.g. in desulphurization plants or road tunnels where de-icing materials are used.)

Design:

- Anchorages are designed under the responsibility of an engineer experienced in anchorages and concrete work.
- Verifiable calculation notes and drawings are prepared taking account of the loads to be anchored. The position of the anchor is indicated on the design drawings (e.g. position of the anchor relative to reinforcement or to supports, etc.).
- The strength class and the length of the fastening screw or threaded rod shall be defined by the designing engineer
- Anchorages under static or quasi-static actions are designed in accordance with:
 - ETAG 001, Annex C, design method A, Edition August 2010 or
 - CEN/TS 1992-4:2009, Annex C, design method A

Installation:

- Anchor installation carried out by appropriately qualified personnel and under the supervision of the person responsible for technical matters of the site,
- Anchor installation in accordance with the manufacturer's specifications and drawings and using the appropriate tools,
- Drill hole by hammer drilling only,
- Positioning of the drill holes without damaging the reinforcement.

TOX Drop-in Anchor E / ES

Intended use
Specifications

Annex B1

Table B1: Installation parameters

Anchor size		M6x30	M8x30	M8x40	M10x30	M10x40	M12x50	M12x80	M16x65	M16x80	M20x80
Depth of drill hole	$h_0 =$ [mm]	30	30	40	30	40	50	80	65	80	80
Drill hole diameter	$d_0 =$ [mm]	8	10	10	12	12	15	15	20	20	25
Cutting diameter of drill bit	$d_{cut} \leq$ [mm]	8,45	10,45	10,45	12,5	12,5	15,5	15,5	20,55	20,55	25,55
Max. installation torque ¹⁾	$T_{inst} \leq$ [Nm]	4	8	8	15	15	35	35	60	60	120
Diameter of clearance hole in the fixture	$d_f \leq$ [mm]	7	9	9	12	12	14	14	18	18	22
Available thread length	L_{th} [mm]	13	13	20	12	15	18	45	23	38	34
Minimum screw-in depth	L_{sdmin} [mm]	7	9	9	10	11	13	13	18	18	22
Steel, zinc plated											
Minimum thickness of member	h_{min} [mm]	100	100	100	120	120	130	130	160	160	200
Minimum spacing	s_{min} [mm]	55	60	80	100	100	120	120	150	150	160
Minimum edge distance	c_{min} [mm]	95	95	95	115	135	165	165	200	200	260
Stainless steel A4, HCR											
Minimum thickness of member	h_{min} [mm]	100	100	100	-	130	140	140	160	160	250
Minimum spacing	s_{min} [mm]	50	60	80	-	100	120	120	150	150	160
Minimum edge distance	c_{min} [mm]	80	95	95	-	135	165	165	200	200	260

¹⁾ If the screw or threaded rod is otherwise secured against unscrewing, the torque can be omitted.

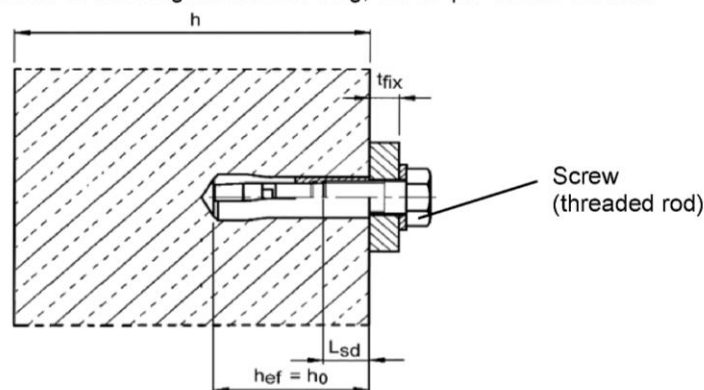

Requirements of the fastening screw or the threaded rod and nut according to the engineering documents:

- Minimum screw-in depth L_{sdmin} see Table B1
- The length of screw or the threaded rod shall be determined depending on the thickness of fixture t_{fix} , available thread length L_{th} (= maximum screw-in depth) and the minimum screw-in depth L_{sdmin} .
- $A_5 > 8$ % ductility

Steel, zinc plated

- Property class 4.6 / 5.6 / 5.8 or 8.8 according to EN ISO 898-1:2013 or EN ISO 898-2:2012

Stainless steel A4

- Material 1.4401; 1.4404; 1.4578; 1.4571; 1.4439; 1.4362 EN 10088:2005
- Property class 70 or 80 according to EN ISO 3506:2010

High corrosion resistant steel (HCR)

- Material 1.4529; 1.4565 EN 10088:2005
- Property class 70 or 80 according to EN ISO 3506:2010

TOX Drop-in Anchor E / ES

Intended use
Installation parameters

Annex B2

Installation instructions

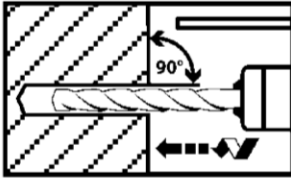

Drill hole perpendicular to concrete surface.

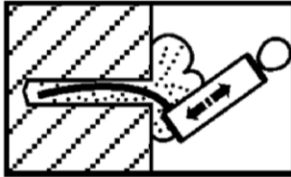

Blow out dust.

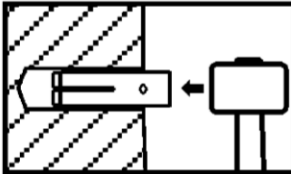

Drive in anchor.

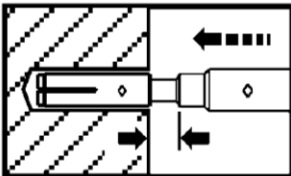

Drive in cone by using setting tool.

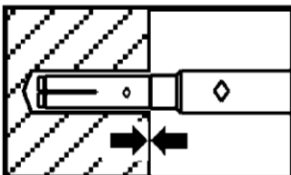

Shoulder of setting tool must fit on anchor rim.

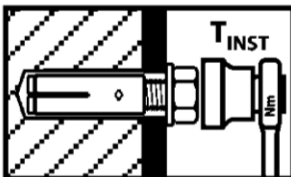

Apply installation torque T_{inst} by using torque wrench.

TOX Drop-in Anchor E / ES

Intended use
Installation instructions

Annex B3

Table C1: Characteristic values for tension loads, zinc plated steel
(Design method A according to ETAG 001, Annex C or CEN/TS 1992-4)

Anchor size			M6x30 ¹⁾	M8x30 ¹⁾	M8x40	M10x30 ¹⁾	M10x40	M12x50 M12x80	M16x65 M16x80	M20x80	
Installation safety factor	$\gamma_2 = \gamma_{inst}$	[-]	1,2								
Steel failure											
Characteristic resistance Steel 4.6	$N_{RK,s}$	[kN]	8,0	14,6		23,2		33,7	62,8	98,0	
Partial safety factor	γ_{Ms}	[-]	2,0								
Characteristic resistance Steel 5.6	$N_{RK,s}$	[kN]	10,0	18,3		18,0	20,2	42,1	78,3	122,4	
Partial safety factor	γ_{Ms}	[-]	2,0			1,5		2,0			
Characteristic resistance Steel 5.8	$N_{RK,s}$	[kN]	10,0	17,6	18,3	18,0	20,2	42,1	67,1	106,4	
Partial safety factor	γ_{Ms}	[-]	1,5						1,6		
Characteristic resistance Steel 8.8	$N_{RK,s}$	[kN]	15,0	17,6	19,9	18,0	20,2	43,0	67,1	106,4	
Partial safety factor	γ_{Ms}	[-]	1,5						1,6		
Pull-out failure											
Characteristic resistance in concrete C20/25	$N_{RK,p}$	[kN]	2)	2)	9	2)	2)	2)	2)	2)	
Increasing factor for $N_{RK,p}$	ψ_C	[-]	$\left(\frac{f_{ck,cube}}{25}\right)^{0,3}$								
Concrete cone failure and splitting											
Effective anchorage depth	h_{ef}	[mm]	30	30	40	30	40	50	65	80	
Spacing (edge distance)	$s_{cr,N} (= 2 c_{cr,N})$	[mm]	3 h_{ef}								
	$s_{cr,sp} (= 2 c_{cr,sp})$	[mm]	190	190	190	230	270	330	400	520	
Factor according to CEN/TS 1992-4	k_{ucr}	[-]	10,1								

¹⁾ Use restricted to anchoring of structural components statically indeterminate

²⁾ Pull-out is not decisive

TOX Drop-in Anchor E / ES

Performance

Characteristic values for **tension loads, zinc plated steel**
(Design method A according to ETAG 001, Annex C or CEN/TS 1992-4)

Annex C1

Table C2: Characteristic values for tension loads, stainless steel A4, HCR
(Design method A according to ETAG 001, Annex C or CEN/TS 1992-4)

Anchor size		M6x30 ¹⁾	M8x30 ¹⁾	M8x40	M10x40	M12x50 M12x80	M16x65 M16x80	M20x80
Installation safety factor	$\gamma_2 = \gamma_{inst}$ [-]	1,0						
Steel failure								
Characteristic resistance (property class 70)	$N_{Rk,s}$ [kN]	14,1	23,3	29,4	50,2	83,8	133,0	
Characteristic resistance (property class 80)	$N_{Rk,s}$ [kN]	17,5	23,3	29,4	50,2	83,8	133,0	
Partial safety factor	γ_{Ms} [-]	1,87						
Pull-out failure								
Characteristic resistance in concrete C20/25	$N_{Rk,p}$ [kN]	2)	2)	9	2)	2)	2)	2)
Increasing factor for $N_{Rk,p}$	ψ_C [-]	$\left(\frac{f_{ck,cube}}{25}\right)^{0,5}$						
Concrete cone failure and splitting								
Effective anchorage depth	h_{ef} [mm]	30 ³⁾	30	40	40	50	65	80
Spacing (edge distance)	$s_{cr,N} (= 2 c_{cr,N})$ [mm]	3 h_{ef}						
	$s_{cr,sp} (= 2 c_{cr,sp})$ [mm]	160	190	190	270	330	400	520
Factor according to CEN/TS 1992-4	k_{ucr} [-]	10,1						

¹⁾ Use restricted to anchoring of structural components statically indeterminate

²⁾ Pull-out is not decisive

³⁾ For proof against concrete cone failure as per ETAG 001, annex C or CEN/TS 1992-4-4, $N_{Rk,c}^0$ must be multiplied by the factor $(25/f_{ck,cube})^{0,2}$.

TOX Drop-in Anchor E / ES

Performance

Characteristic values for tension loads, stainless steel A4, HCR
(Design method A according to ETAG 001, Annex C or CEN/TS 1992-4)

Annex C2

Table C3: Characteristic values for **shear loads, zinc plated steel**
(Design method A according to ETAG 001, Annex C or CEN/TS 1992-4)

Anchor size			M6x30 ¹⁾	M8x30 ¹⁾	M8x40	M10x30 ¹⁾	M10x40	M12x50 M12x80	M16x65 M16x80	M20x80
Steel failure without lever arm										
Characteristic resistance Steel 4.6	$V_{Rk,s}$	[kN]	4,0	7,3	11,6	9,6	16,8	31,3	49,0	
Partial safety factor	γ_{Ms}	[-]	1,67							
Characteristic resistance Steel 5.6	$V_{Rk,s}$	[kN]	5,0	9,1	10,1	9,6	21,1	39,2	61,2	
Partial safety factor	γ_{Ms}	[-]	1,67		1,25	1,67				
Characteristic resistance Steel 5.8	$V_{Rk,s}$	[kN]	5,0	6,9	10,1	7,2	21,1	33,5	53,2	
Partial safety factor	γ_{Ms}	[-]	1,25						1,33	
Characteristic resistance Steel 8.8	$V_{Rk,s}$	[kN]	5,0	6,9	10,1	7,2	21,5	33,5	53,2	
Partial safety factor	γ_{Ms}	[-]	1,25						1,33	
Factor of ductility	k_2	[-]	1,0							
Steel failure with lever arm										
Characteristic resistance Steel 4.6	$M^0_{Rk,s}$	[Nm]	6,1	15	30	30	52	133	259	
Partial safety factor	γ_{Ms}	[-]	1,67							
Characteristic resistance Steel 5.6	$M^0_{Rk,s}$	[Nm]	7,6	19	37	37	65	166	324	
Partial safety factor	γ_{Ms}	[-]	1,67							
Characteristic resistance Steel 5.8	$M^0_{Rk,s}$	[Nm]	7,6	19	37	37	65	166	324	
Partial safety factor	γ_{Ms}	[-]	1,25							
Characteristic resistance Steel 8.8	$M^0_{Rk,s}$	[Nm]	12	30	59	60	105	266	519	
Partial safety factor	γ_{Ms}	[-]	1,25							
Factor of ductility	k_2	[-]	1,0							
Concrete pry-out failure										
Factor k acc. ETAG 001, Annex C or k ₃ acc. CEN/TS 1992-4	$k_{(3)}$	[-]	1,0					1,5	2,0	
Concrete edge failure										
Effective length of anchor under shear loading	l_f	[mm]	30	30	40	30	40	50	65	80
Outside diameter of anchor	d_{nom}	[mm]	8	10	10	12	12	15	20	25

¹⁾ Use restricted to anchoring of structural components statically indeterminate

TOX Drop-in Anchor E / ES

Performance

Characteristic values for **shear loads, zinc plated steel**
(Design method A according to ETAG 001, Annex C or CEN/TS 1992-4)

Annex C3

Table C4: Characteristic values for shear loads, stainless steel A4, HCR
(Design method A according to ETAG 001, Annex C or CEN/TS 1992-4)

Anchor size			M6x30 ¹⁾	M8x30 ¹⁾	M8x40	M10x40	M12x50 M12x80	M16x65 M16x80	M20x80
Steel failure without lever arm									
Characteristic resistance (property class 70)	$V_{Rk,s}$	[kN]	7,0	10,6	13,4	25,1	41,9	66,5	
Characteristic resistance (property class 80)	$V_{Rk,s}$	[kN]	8,7	10,6	13,4	25,1	41,9	66,5	
Partial safety factor	γ_{Ms}	[-]	1,56						
Factor of ductility	k_2	[-]	1,0						
Steel failure with lever arm									
Characteristic resistance (property class 70)	$M^0_{Rk,s}$	[Nm]	11	26	52	92	233	454	
Partial safety factor	γ_{Ms}	[-]	1,56						
Characteristic resistance (property class 80)	$M^0_{Rk,s}$	[Nm]	12	30	60	105	266	519	
Partial safety factor	γ_{Ms}	[-]	1,33						
Factor of ductility	k_2	[-]	1,0						
Concrete pry-out failure									
Factor k acc. ETAG 001, Annex C or k_3 acc. CEN/TS 1992-4	$k_{(3)}$	[-]	1,0	1,7	1,7	2,0			
Concrete edge failure									
Effective length of anchor under shear loading	l_f	[mm]	30	30	40	40	50	65	80
Outside diameter of anchor	d_{nom}	[mm]	8	10	10	12	15	20	25

¹⁾ Use restricted to anchoring of structural components statically indeterminate

TOX Drop-in Anchor E / ES

Performance

Characteristic values for **shear loads, stainless steel A4, HCR**
(Design method A according to ETAG 001, Annex C or CEN/TS 1992-4)

Annex C4

Table C5: Displacements under tension loads

Anchor size			M6x30	M8x30	M8x40	M10x30	M10x40	M12x50 M12x80	M16x65 M16x80	M20x80
Steel zinc plated										
Tension load in non-cracked concrete	N	[kN]	3	3	3,6	3,3	4,8	6,4	10	14,8
Displacement	δ_{N0}	[mm]	0,24							
	$\delta_{N\infty}$	[mm]	0,36							
Stainless steel A4 / HCR										
Tension load in non-cracked concrete	N	[kN]	4	4	4,3	-	6,1	8,5	12,6	17,2
Displacement	δ_{N0}	[mm]	0,12							
	$\delta_{N\infty}$	[mm]	0,24							

Table C6: Displacements under shear loads

Anchor size			M6x30	M8x30	M8x40	M10x30	M10x40	M12x50 M12x80	M16x65 M16x80	M20x80
Steel zinc plated										
Shear load in non-cracked concrete	V	[kN]	2	4	4	5,7	4,0	11,3	18,8	32,2
Displacement	δ_{V0}	[mm]	0,9	0,9	1,0	1,5	0,6	1,2	1,2	1,6
	$\delta_{V\infty}$	[mm]	1,3	1,3	1,5	2,3	0,9	1,9	1,9	2,4
Stainless steel A4 / HCR										
Shear load in non-cracked concrete	V	[kN]	3,5	5,2	5,2	-	6,5	11,5	19,2	30,4
Displacement	δ_{V0}	[mm]	1,9	1,1	0,7	-	1,0	1,7	2,4	2,6
	$\delta_{V\infty}$	[mm]	2,8	1,6	1,0	-	1,5	2,6	3,6	3,8

TOX Drop-in Anchor E / ES

Performance
Displacements

Annex C5