

Approval body for construction products
and types of construction

Bautechnisches Prüfamt

An institution established by the Federal and
Laender Governments



European Technical Assessment

ETA-06/0144
of 30 June 2016

English translation prepared by DIBt - Original version in German language

General Part

Technical Assessment Body issuing the
European Technical Assessment:

Deutsches Institut für Bautechnik

Trade name of the construction product

Kenngott Hanging Stair

Product family
to which the construction product belongs

Prefabricated stair with steps and a load-bearing handrail
made of solid wood for use as an indoor stair in buildings

Manufacturer

Kenngott - Treppen Servicezentrale
Longlife - Treppen GmbH
Neulandstraße 31
74889 Sinsheim
DEUTSCHLAND

Manufacturing plant

Longlife - Treppen GmbH, Werk 1 und 2

This European Technical Assessment
contains

14 pages including 3 annexes which form an integral part
of this assessment

This European Technical Assessment is
issued in accordance with Regulation (EU)
No 305/2011, on the basis of

European Assessment Document (EAD)
340006-00-0506

The European Technical Assessment is issued by the Technical Assessment Body in its official language. Translations of this European Technical Assessment in other languages shall fully correspond to the original issued document and shall be identified as such.

Communication of this European Technical Assessment, including transmission by electronic means, shall be in full. However, partial reproduction may only be made with the written consent of the issuing Technical Assessment Body. Any partial reproduction shall be identified as such.

This European Technical Assessment may be withdrawn by the issuing Technical Assessment Body, in particular pursuant to information by the Commission in accordance with Article 25(3) of Regulation (EU) No 305/2011.

Specific Part

1 Technical description of the product

The Kenngott Hanging Stair is a prefabricated stair, which consists of steps, a railing (consisting of handrail, posts and balusters), fasteners, load-bearing bolts and wall ties.

On the wall-free side the steps are connected with each other by a load-bearing bolt and via balusters with the load-bearing handrail. On the wall side each step is equipped with two wall ties which are anchored in the staircase wall. Alternatively, the staircase wall may also be replaced by a stringer or as on the wall-free side by a load-bearing handrail.

The steps, the handrail and the posts are made of solid wood, the balusters are made of steel or solid wood and the fasteners, load-bearing bolts and wall ties are made of steel.

The product description is given in Annex A.

2 Specification of the intended use in accordance with the applicable European Assessment Document

The performances given in Section 3 are only valid if the stair is used in compliance with the specifications and conditions given in Annex B.

The verification and assessment methods on which this European Technical Assessment is based lead to the assumption of a working life of the stair of at least 50 years. The indications given on the working life cannot be interpreted as a guarantee given by the producer, but are to be regarded only as a means for choosing the right products in relation to the expected economically reasonable working life of the works.

3 Performance of the product and references to the methods used for its assessment

3.1 Mechanical resistance and stability (BWR 1)

Essential characteristic	Performance
Load-bearing capacity of stair	See Annex C2
Load-bearing capacity of fixings	See technical documentation of this European Technical Assessment
Load/displacement behaviour	See Annex C2
Vibration behaviour	First natural frequency: $f_1 \geq 5$ Hz (inclusive a single mass of 100 kg) Deflection under a single load $F = 1$ kN: $w \leq 5$ mm
Prevention of progressive collapse	Failure of individual components of the stair does not lead to a progressive collapse of the complete stair
Residual load-bearing capacity	Local material failure does not lead to an abrupt total loss of load-bearing capacity of the steps.
Long-term behaviour	Load-bearing capacity are ensured under an appropriate use and maintenance over the indicated working life
Resistance to earthquakes	No performance assessed
Durability against physical, chemical and biological agents	Adequate durability for the intended use under an appropriate use and maintenance

3.2 Safety in case of fire (BWR 2)

Essential characteristic	Performance
Reaction to fire	See Annex A5
Fire resistance	No performance assessed

3.3 Hygiene, health and the environment (BWR 3)

Essential characteristic	Performance
Release of formaldehyde	Class E1
Release of pentachlorophenol	No pentachlorophenol treated materials are used
Radioactive emission	Not relevant

English translation prepared by DIBt

3.4 Safety in use (BWR 4)

Essential characteristic	Performance
Geometry	See Annex C1
Slipperiness	No performance assessed
Equipment of the stair for a safe use	Barrier and handrail are components of the stair (see Annexes A1 to A4 and C1) If vertical balusters, arranged between step and handrail, used as fill-in elements, a climb ability for infants will not be supported Tactility and visibility: No performance assessed
Safe breakage of components	No brittle failure of individual components
Impact resistance	No performance assessed

4 Assessment and verification of constancy of performance (AVCP) system applied, with reference to its legal base

In accordance with the European Assessment Document EAD No. 340006-00-0506 the applicable European legal act is: 1999/89/EC

The System to be applied is: 2+

In addition, with regard to reaction to fire for products covered by the European Assessment Document EAD No. 340006-00-0506 the applicable European legal act is: 2001/596/EC

The System to be applied is: 4

5 Technical details necessary for the implementation of the AVCP system, as provided for in the applicable European Assessment Document

Technical details necessary for the implementation of the AVCP system are laid down in the control plan deposited at Deutsches Institut für Bautechnik.

Issued in Berlin on 30 June 2016 by Deutsches Institut für Bautechnik

Uwe Bender
Head of Department

beglaubigt:
Stiller

Types of plan

Walking line exemplified, position may be chosen freely within the walking zone, walking zone is 20 % of the clear width of the stair in the middle of the stair

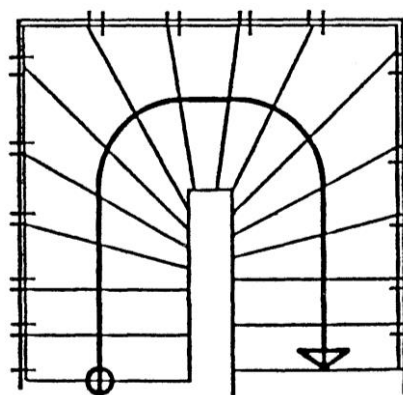
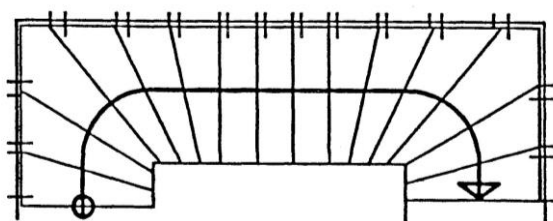
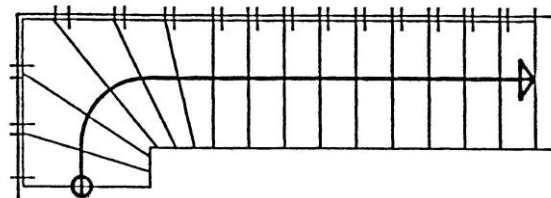
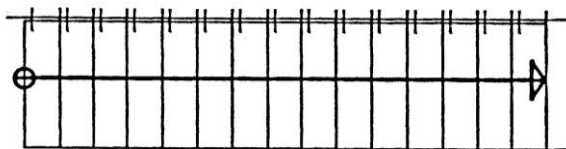

Types of construction

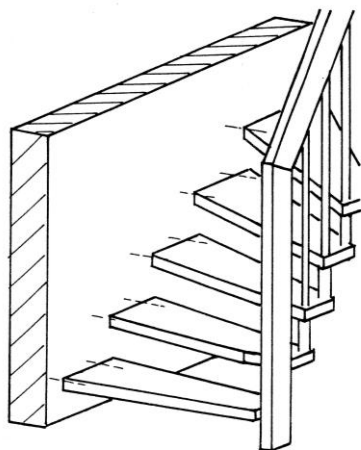

Length according Annex C1

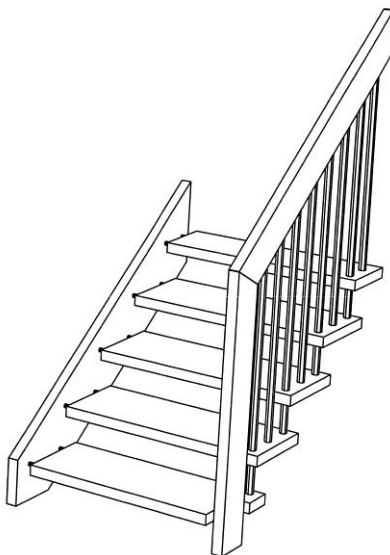

Length according Annex C1, horizontal wall fastening according to the technical documentation

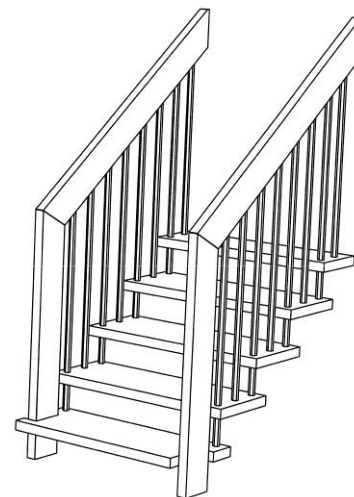

Length and horizontal wall fastening according to the technical documentation

Kenngott Hanging Stair

Product and intended use

Annex A1

System baluster

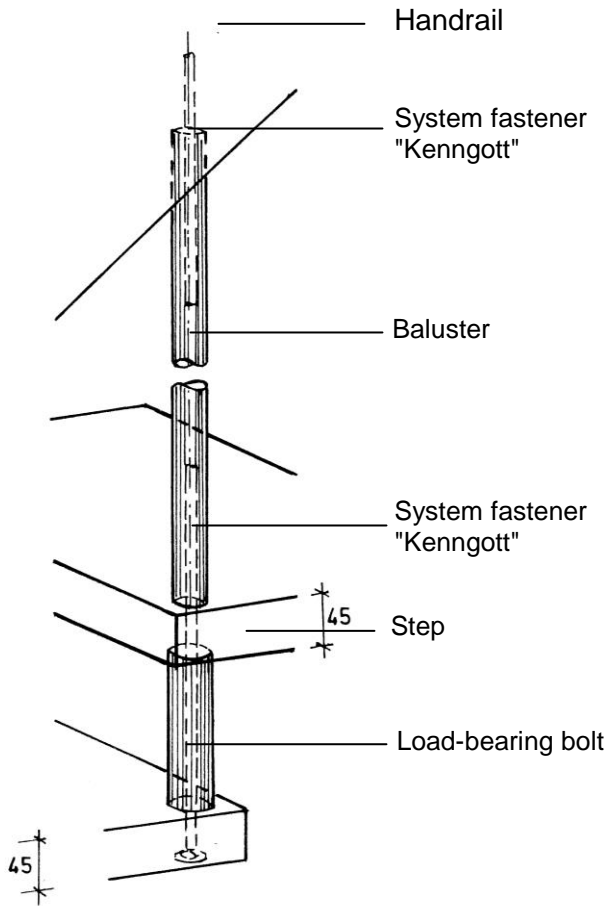

Fastener handrail

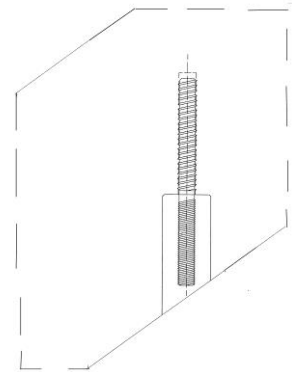

Fastener baluster

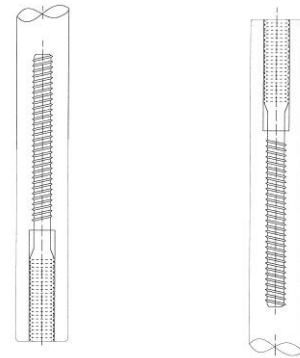

Load-bearing bolt between steps

Load-bearing bolt SE V11

Load-bearing bolt steel

Load-bearing bolt wood

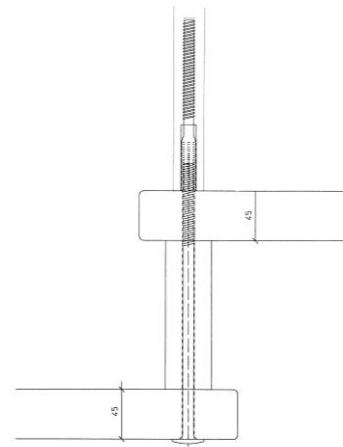
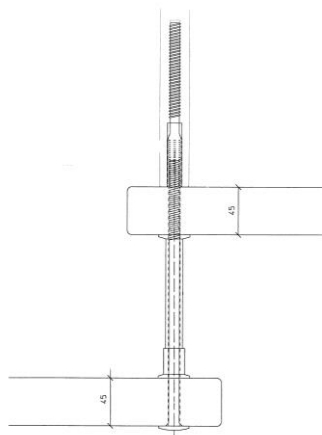
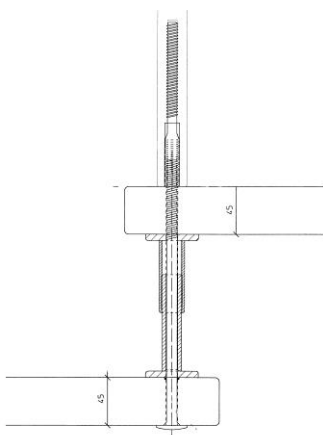

Kenngott Hanging Stair

System baluster, Fastener handrail and baluster,
Load-bearing bolts

Annex A2

English translation prepared by DIBt

Post – handrail joint

finger jointed

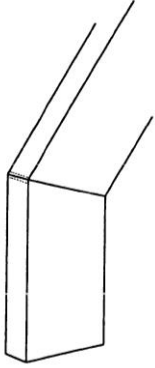

screwed

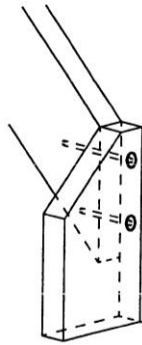

screwed

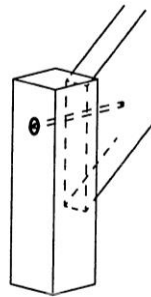

screwed

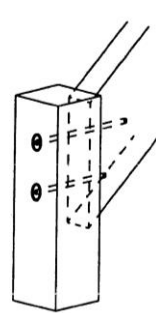

Handrail corner joint

screwed

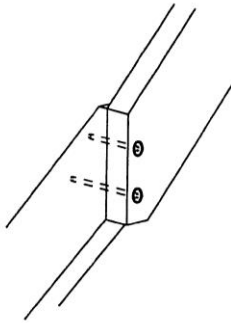

screwed

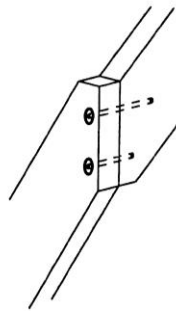

finger jointed

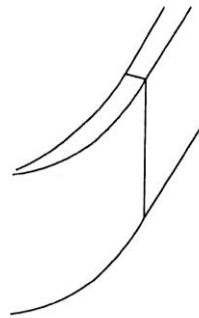

Wall tie

Minimum wall thickness and minimum strength of the wall material as well as distances to the wall according to the technical documentation

Masonry

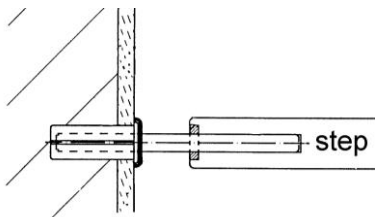

Concrete

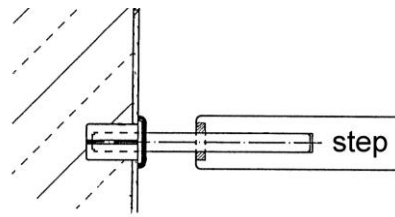

Particle board or OSB plate

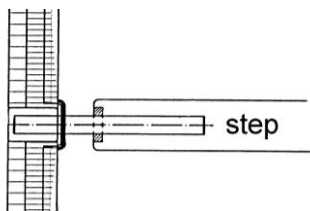

Stringer (solid wood)

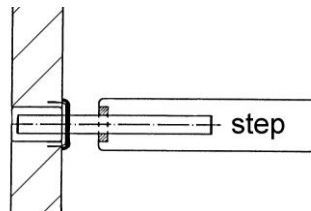

Kenngott Hanging Stair

Post - handrail joints, Handrail corner joints,
Wall ties

Annex A3

Post joint at bottom ¹⁾

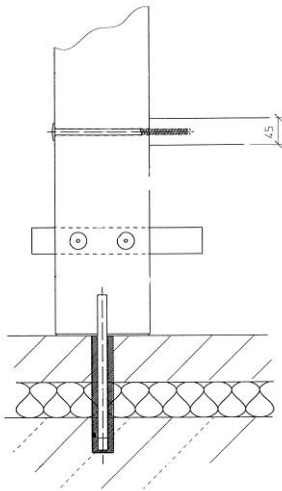

Post joint at the top ¹⁾

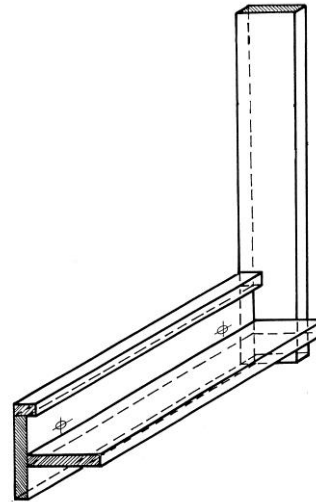

Post – step joint ¹⁾

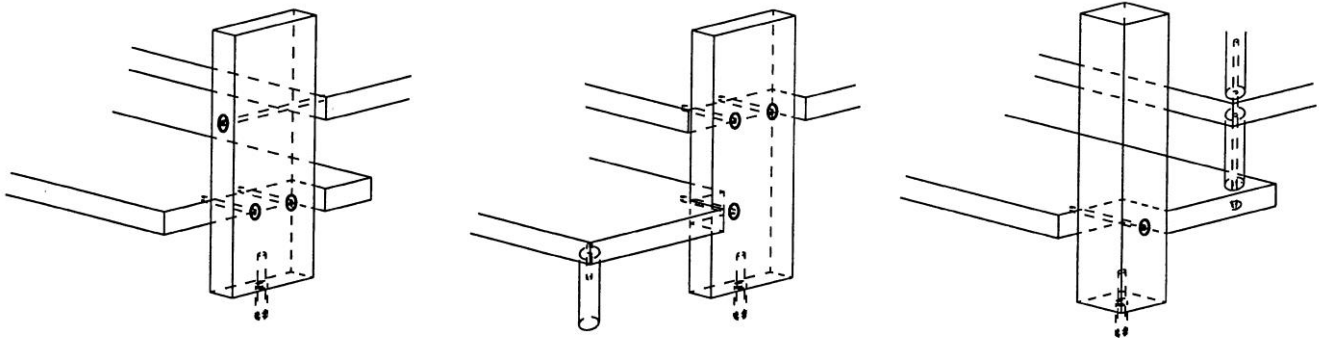

¹⁾ more details according to the technical documentation

Kenngott Hanging Stair

Post joint at bottom, Post joint at the top,
Post – step joint

Annex A4

Table 1: Minimum dimensions of components of the stair and reaction to fire

Component of stair		Material ⁴⁾	Dimension		Value	Reaction to fire
steps		solid wood ¹⁾	thickness	[mm]	45	D-s2, d0
upper flange of the railing / handrail	straight flights only finger jointed	solid wood ¹⁾	height / width	[mm]	160 / 53 (45) ²⁾	D-s2, d0
	other flights	solid wood ¹⁾	height / width	[mm]	160 / 45	
posts	straight flights only finger jointed	solid wood ¹⁾	cross section a/b	[mm]	160 / 53 (45) ²⁾	D-s2, d0
	other flights	solid wood ¹⁾	cross section a/b	[mm]	80 / 80 or 160 / 45	
			diameter	[mm]	90	
baluster		solid wood ¹⁾	diameter	[mm]	28	D-s2, d0
		steel pipe	diameter	[mm]	16	A1
			wall thickness	[mm]	1.5	
load-bearing bolt / system fastener		steel	- ³⁾		- ³⁾	A1
load-bearing bolt / distance sleeve		solid wood ¹⁾	diameter	[mm]	16 or SE V11	
		steel	diameter	[mm]	42	D-s2, d0
wall ties		round steel	diameter	[mm]	16	A1
			embedment depth wall	[mm]	60 (40) ⁵⁾	
			embedment depth step	[mm]	100	
bearing sleeve for wall tie		plastic	diameter	[mm]	40	not relevant
stringer		solid wood ¹⁾	thickness / height	[mm]	45 / 300	D-s2, d0

¹⁾ only hardwood of the following species: beech, oak, common ash, maple

²⁾ value in brackets if handrail is fixed in height of the floor slab

³⁾ characteristic values according to the technical documentation

⁴⁾ characteristic values of materials according to the technical documentation

⁵⁾ masonry: embedment depth 60 mm,
concrete, particle board, OSB, stringer: embedment depth 40 mm

Kenngott Hanging Stair

Minimum dimensions of components of the stair
and reaction to fire

Annex A5

Specification of intended use (Part 1)

Intended use:

- European Technical Assessment applies for a construction system.
- For the specific case of use the corresponding type of stair is manufactured within the context of the values defined in this European Technical Assessment.
- Values of this ETA applies to all types of stairs, the real dimensions follow in accordance with the relevant case of use.

Stair subject to:

- Static and quasi static loads

Use conditions:

- Indoor stair
- Air temperatures between +5 °C and +30 °C
- Relative air humidity between 30% and 70%

Design:

- Design of the stair according to the annexes and the technical documentation of this European Technical Assessment.
- Fastening of the stair to the construction works according to the annexes and the technical documentation of this Technical European Assessment.
- Verification of the transmission of loads to the construction works by the civil engineer responsible for the construction works.
- Load bearing capacity at ultimate limit state:

$$q_k \cdot \gamma_Q \leq q_{RK} / \gamma_M$$

$$Q_k \cdot \gamma_Q \leq Q_{RK} / \gamma_M$$

$$h_k \cdot \gamma_Q \cdot \psi_0 \leq h_{RK} / \gamma_M$$

with

q_{RK}, Q_{RK}, h_{RK} : characteristic values of resistance; see Table 3

γ_M : recommended material partial safety factor; see Table 3

q_k, Q_k, h_k : characteristic values of imposed loads according to EN 1991-1-1:2010-12

$\gamma_Q = 1.5$: recommended partial safety factor, in absence of other national regulations

$\psi_0 = 0.7$: recommended combination factor, in absence of other national regulations

- Maximum characteristic values of imposed loads under consideration of the partial factors mentioned above; see Table 5

Kenngott Hanging Stair	Annex B1
Specification of intended use (Part 1)	

Specification of intended use (Part 2)

Installation:

- Installation by personal appropriately trained and authorized by the holder of the assessment by means of the technical documentation of this European Technical Assessment
- Installation only in the way as specified in the technical documentation of this European Technical Assessment
- Installation of timber components when moisture content of timber components is $8 \pm 2 \%$
- Sufficient support of the stair when assembling
- Installation of stair components without imposed deformations
- Installation of stair components without significant defects and cracks
- Replacing of stair components, which begin tearing when assembling
- Bolted connection are protected such that they will not be loosened by vibrations

Indication of the manufacturer:

- Ensure that all persons involved will be appropriately informed about the specific conditions according to sections 1 and 2 (including the annexes to which reference is being made as well as the not confidential parts of the technical documentation deposited to this European Technical Assessment)
- Packaging of timber components such that the wood moisture is $8 \pm 2 \%$ during transport and storage
- Instructions for use should provide information as to use, maintenance and repair of the stair. Including the information of avoidance of moisture penetration of the timber components and of retightens the bolting of the load-bearing bolts and connections according to Annexes A2 to A4 after the first heating season and the information on the relationship between moisture content of timber components, air temperature and relative air humidity

electronic copy of the eta by dibt: eta-06/0144

Kenngott Hanging Stair	Annex B2
Specification of intended use (Part 2)	

Table 2: Geometry

designation			dimension	
			minimum	maximum
going	step on walking line ¹⁾	[mm]	210	370 ²⁾
	tapered step	[mm]	60 ^{2) 3)}	600 ^{2) 4)}
rise of the stairs ¹⁾		[mm]	140 ²⁾	210
pitch of the walking line ¹⁾		[°]	21	45
overlap of the steps		[mm]	40	- ⁵⁾
number of rises		[-]	3	16
openings	between barrier and other parts of the stair	[mm]	0	0
	between stairs and wall	[mm]	- ⁵⁾	50
	between consecutive steps	[mm]	- ⁵⁾	165
	between balusters	[mm]	40	120
clear width of stairs		[mm]	500	1000
minimum headroom		[mm]	- ⁵⁾	
length of the flight		[mm]	- ⁵⁾	4050
thickness of steps		[mm]	45	- ⁵⁾
height of the railing (barrier) / handrail		[mm]	800	1200
thickness of the handrail		[mm]	45	53
height of the handrail		[mm]	160	- ⁵⁾

- 1) values are constant within one flight
 2) tolerance between nominal value and actual value= ± 5 mm
 3) inside of tapered step
 4) outside of tapered step
 5) not relevant

- 1 going
 2 rise
 3 overlap
 4 opening between consecutive steps
 5 length of the flight
 6 thickness of steps
 7 height of the railing / barrier
 8 opening between balusters

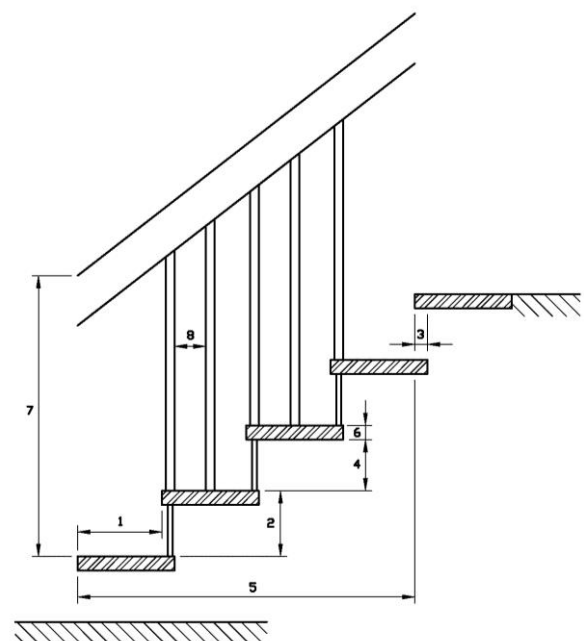

Kenngott Hanging Stair

Geometry of the stair

Annex C1

Table 3: Load-bearing capacity – Characteristic values of resistance

Type of loading	Characteristic values of resistance			γ_M ¹⁾
vertical variable uniformly distributed load	$q_{R,k}$	[kN/m ²]	10.5	1,5
vertical variable single load	$Q_{R,k}$	[kN]	4.5	
horizontal variable uniformly distributed load on barrier	$h_{R,k}$	[kN/m]	0.8	

¹⁾ Recommended partial safety factor, in absence of other national regulations

Table 4: Deflections under loading

Deflection of the flight under uniformly distributed load			
uniformly distributed load	q_k	[kN/m ²]	3.0
length of the median line of the flight	L	[mm]	4050
deflection under load F_S related to the median line of the flight	w	[-]	$\leq L/200$
Deflection of the step under single point load			
single load	Q_k	[kN]	2.0
clear width of the stair	L	[mm]	1000
deflection under load F_S related to the clear width of the stair	w	[-]	$\leq L/200$

Table 5: Imposed loads

Type of loading	Imposed loads		
vertical variable uniformly distributed load	q	[kN/m ²]	3.5
vertical variable single load	Q	[kN]	2.0
horizontal variable uniformly distributed load on barrier	h	[kN/m]	0.5

Kenngott Hanging Stair

Load-bearing capacity – Characteristic values of resistance
Deflections under loading,
Imposed loads

Annex C2