

Approval body for construction products  
and types of construction

Bautechnisches Prüfamt

An institution established by the Federal and  
Laender Governments



## European Technical Assessment

**ETA-09/0078**  
**of 19 January 2016**

English translation prepared by DIBt - Original version in German language

### General Part

Technical Assessment Body issuing the  
European Technical Assessment:

Deutsches Institut für Bautechnik

Trade name of the construction product

Injection System GEBOFIX PRO VE-SF,  
GEBOFIX PRO VE-SF NORDIC for concrete

Product family  
to which the construction product belongs

Bonded Anchor with Anchor rod for use in concrete

Manufacturer

G&B FISSAGGI  
Corso Savona, 22  
10029 Villatellone (TO)  
ITALIEN

Manufacturing plant

G&B Fissaggi S.R.L., Plant4

This European Technical Assessment  
contains

22 pages including 3 annexes which form an integral part  
of this assessment

This European Technical Assessment is  
issued in accordance with Regulation (EU)  
No 305/2011, on the basis of

Guideline for European technical approval of "Metal  
anchors for use in concrete", ETAG 001 Part 5: "Bonded  
anchors", April 2014,  
used as European Assessment Document (EAD)  
according to Article 66 Paragraph 3 of Regulation (EU)  
No 305/2011.

This version replaces

ETA-09/0078 issued on 30 January 2015

The European Technical Assessment is issued by the Technical Assessment Body in its official language. Translations of this European Technical Assessment in other languages shall fully correspond to the original issued document and shall be identified as such.

Communication of this European Technical Assessment, including transmission by electronic means, shall be in full. However, partial reproduction may only be made with the written consent of the issuing Technical Assessment Body. Any partial reproduction shall be identified as such.

This European Technical Assessment may be withdrawn by the issuing Technical Assessment Body, in particular pursuant to information by the Commission in accordance with Article 25(3) of Regulation (EU) No 305/2011.

## Specific Part

### 1 Technical description of the product

The "Injection system GEBOFIX PRO VE-SF, GEBOFIX PRO VE-SF NORDIC for concrete" is a bonded anchor consisting of a cartridge with injection mortar GEBOFIX PRO VE-SF, GEBOFIX PRO VE-SF NORDIC and a steel element. The steel element consist of a commercial threaded rod with washer and hexagon nut in the range of M8 to M30 or a reinforcing bar in the range of diameter 8 to 32 mm.

The steel element is placed into a drilled hole filled with injection mortar and is anchored via the bond between metal part, injection mortar and concrete.

The product description is given in Annex A.

### 2 Specification of the intended use in accordance with the applicable European Assessment Document

The performances given in Section 3 are only valid if the anchor is used in compliance with the specifications and conditions given in Annex B.

The verifications and assessment methods on which this European Technical Assessment is based lead to the assumption of a working life of the anchor of at least 50 years. The indications given on the working life cannot be interpreted as a guarantee given by the producer, but are to be regarded only as a means for choosing the right products in relation to the expected economically reasonable working life of the works.

### 3 Performance of the product and references to the methods used for its assessment

#### 3.1 Mechanical resistance and stability (BWR 1)

Essential characteristic	Performance
Characteristic resistance tension and shear loads	See Annex C 1 to C 4
Displacements under tension and shear loads	See Annex C 7 to C 8

#### 3.2 Safety in case of fire (BWR 2)

Essential characteristic	Performance
Reaction to fire	Anchorage satisfy requirements for Class A1
Resistance to fire	No performance assessed

#### 3.3 Hygiene, health and the environment (BWR 3)

Regarding dangerous substances there may be requirements (e.g. transposed European legislation and national laws, regulations and administrative provisions) applicable to the products falling within the scope of this European Technical Assessment. In order to meet the provisions of Regulation (EU) No 305/2011, these requirements need also to be complied with, when and where they apply.

#### 3.4 Safety in use (BWR 4)

The essential characteristics regarding Safety in use are included under the Basic Works Requirement Mechanical resistance and stability.

English translation prepared by DIBt

**4 Assessment and verification of constancy of performance (AVCP) system applied, with reference to its legal base**

In accordance with guideline for European technical approval ETAG 001, April 2013 used as European Assessment Document (EAD) according to Article 66 Paragraph 3 of Regulation (EU) No 305/2011 the applicable European legal act is: [96/582/EC].

The system to be applied is: 1

**5 Technical details necessary for the implementation of the AVCP system, as provided for in the applicable EAD**

Technical details necessary for the implementation of the AVCP system are laid down in the control plan deposited with Deutsches Institut für Bautechnik.

Issued in Berlin on 19 January 2016 by Deutsches Institut für Bautechnik

Uwe Bender  
Head of Department

*beglaubigt:*  
Aksünger

### Installation threaded rod

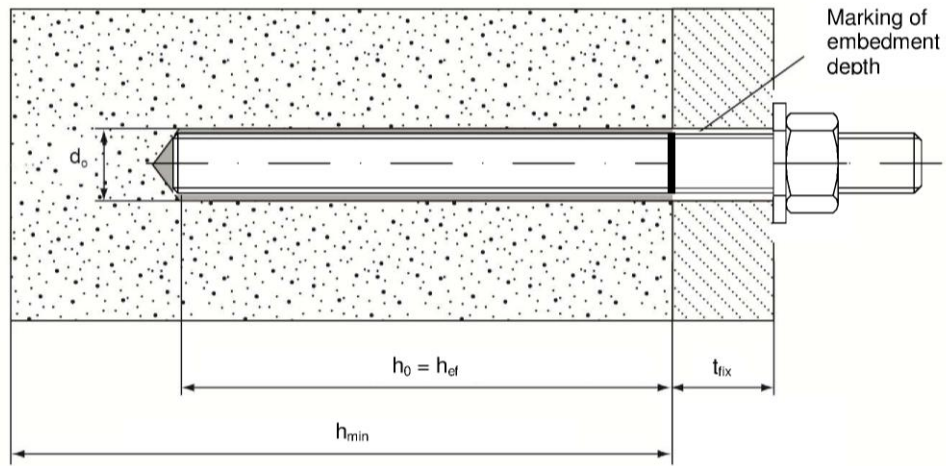

### Installation reinforcing bar

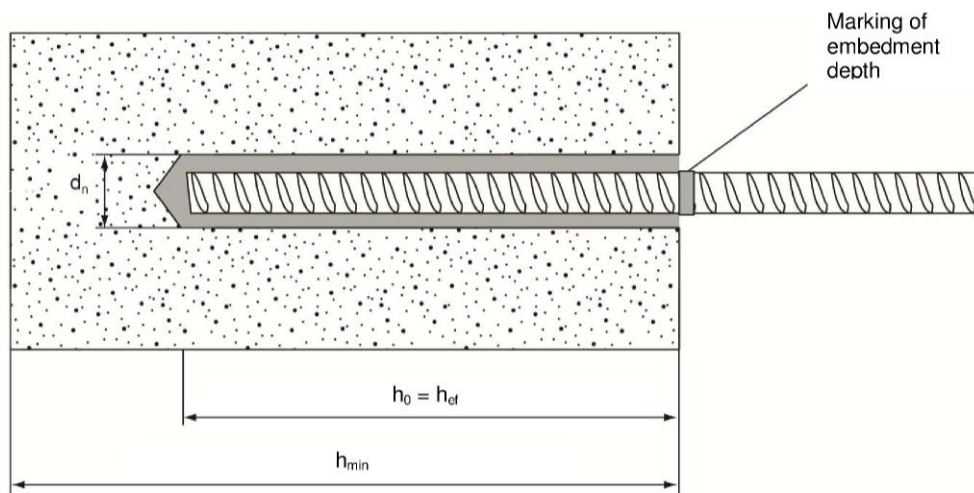

- $d_f$  = diameter of clearance hole in the fixture
- $t_{fix}$  = thickness of fixture
- $h_{ef}$  = effective anchorage depth
- $h_0$  = depth of drill hole
- $h_{min}$  = minimum thickness of member

**Injection system GEBOFIX PRO VE-SF, GEBOFIX PRO VE-SF NORDIC for concrete**

**Product description**  
Installed condition

**Annex A1**

### Injection mortar: GEBOFIX PRO VE-SF

150 ml, 280 ml, 300 ml to 330 ml, 380 ml to 420 ml cartridge (Type: coaxial)



235 ml, 345 ml and 825 ml cartridge (Type: "side-by-side")

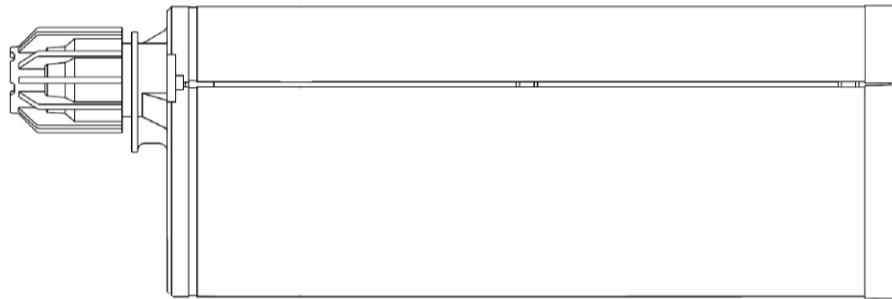

165 ml and 300 ml cartridge (Type: "foil tube")



Cartridge label: GEBOFIX PRO VE-SF or GEBOFIX PRO VE-SF NORDIC, processing notes, charge-code, shelf life, hazard-code, curing- and processing time (depending on the temperature), with as well as without travel scale

### Static mixer



Injection system GEBOFIX PRO VE-SF, GEBOFIX PRO VE-SF NORDIC for concrete

Product description  
Injection system

Annex A2

**Threaded rod M8, M10, M12, M16, M20, M24, M27, M30 with washer and hexagon nut**

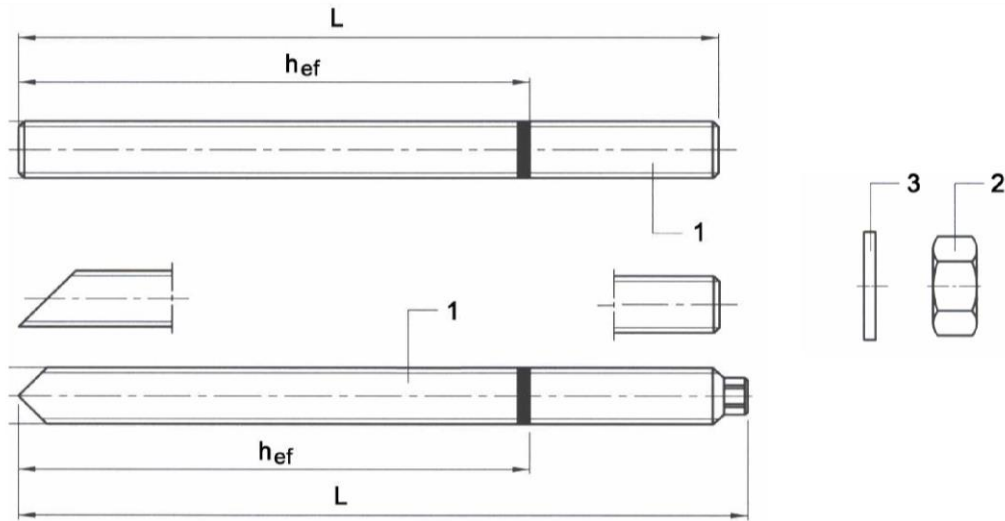

Commercial standard rod with:

- Materials, dimensions and mechanical properties acc. Table A1
- Inspection certificate 3.1 acc. to EN 10204:2004
- Marking of embedment depth

**Reinforcing bar  $\varnothing 8, \varnothing 10, \varnothing 12, \varnothing 14, \varnothing 16, \varnothing 20, \varnothing 25, \varnothing 28, \varnothing 32$**

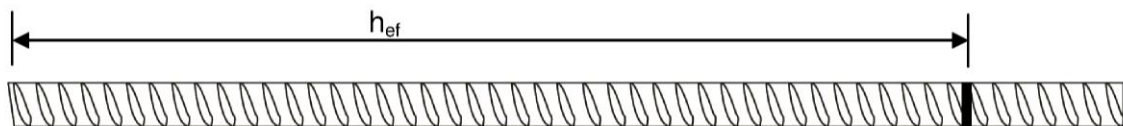

- Minimum value of related rip area  $f_{R,min}$  according to EN 1992-1-1:2004+AC:2010
- Rib height of the bar shall be in the range  $0,05d \leq h \leq 0,07d$   
(d: Nominal diameter of the bar; h: Rip height of the bar)

**Injection system GEBOFIX PRO VE-SF, GEBOFIX PRO VE-SF NORDIC for concrete**

**Product description**  
Threaded rod and reinforcing bar

**Annex A3**

**Table A1: Materials**

Part	Designation	Material
<b>Steel, zinc plated <math>\geq 5 \mu\text{m}</math> acc. to EN ISO 4042:1999 or Steel, hot-dip galvanised <math>\geq 40 \mu\text{m}</math> acc. to EN ISO 1461:2009 and EN ISO 10684:2004+AC:2009</b>		
1	Anchor rod	Steel, EN 10087:1998 or EN 10263:2001 Property class 4.6, 4.8, 5.8, 8.8, EN 1993-1-8:2005+AC:2009 $A_5 > 8\%$ fracture elongation
2	Hexagon nut, EN ISO 4032:2012	Steel acc. to EN 10087:1998 or EN 10263:2001 Property class 4 (for class 4.6 or 4.8 rod) EN ISO 898-2:2012, Property class 5 (for class 5.8 rod) EN ISO 898-2:2012, Property class 8 (for class 8.8 rod) EN ISO 898-2:2012
3	Washer, EN ISO 887:2006, EN ISO 7089:2000, EN ISO 7093:2000 or EN ISO 7094:2000	Steel, zinc plated or hot-dip galvanised
<b>Stainless steel</b>		
1	Anchor rod	Material 1.4401 / 1.4404 / 1.4571, EN 10088-1:2005, > M24: Property class 50 EN ISO 3506-1:2009 $\leq$ M24: Property class 70 EN ISO 3506-1:2009 $A_5 > 8\%$ fracture elongation
2	Hexagon nut, EN ISO 4032:2012	Material 1.4401 / 1.4404 / 1.4571 EN 10088:2005, > M24: Property class 50 (for class 50 rod) EN ISO 3506-2:2009 $\leq$ M24: Property class 70 (for class 70 rod) EN ISO 3506-2:2009
3	Washer, EN ISO 887:2006, EN ISO 7089:2000, EN ISO 7093:2000 or EN ISO 7094:2000	Material 1.4401, 1.4404 or 1.4571, EN 10088-1:2005
<b>High corrosion resistance steel</b>		
1	Anchor rod	Material 1.4529 / 1.4565, EN 10088-1:2005, > M24: Property class 50 EN ISO 3506-1:2009 $\leq$ M24: Property class 70 EN ISO 3506-1:2009 $A_5 > 8\%$ fracture elongation
2	Hexagon nut, EN ISO 4032:2012	Material 1.4529 / 1.4565 EN 10088-1:2005, > M24: Property class 50 (for class 50 rod) EN ISO 3506-2:2009 $\leq$ M24: Property class 70 (for class 70 rod) EN ISO 3506-2:2009
3	Washer, EN ISO 887:2006, EN ISO 7089:2000, EN ISO 7093:2000 or EN ISO 7094:2000	Material 1.4529 / 1.4565, EN 10088-1:2005
<b>Reinforcing bars</b>		
1	Rebar according to EN 1992-1-1:2004+AC:2010, Annex C	Bars and de-coiled rods class B or C $f_{yk}$ and $k$ according to NDP or NCL of EN 1992-1-1/NA:2013 $f_{uk} = f_{tk} = k \cdot f_{yk}$

**Injection system GEBOFIX PRO VE-SF, GEBOFIX PRO VE-SF NORDIC for concrete**

**Product description**  
Materials

**Annex A4**



## Specifications of intended use

### Anchorage subject to:

- Static and quasi-static loads: M8 to M30, Rebar Ø8 to Ø32.
- Seismic action for Performance Category C1: M12 to M30, Rebar Ø12 to Ø32.

### Base materials:

- Reinforced or unreinforced normal weight concrete according to EN 206-1:2000.
- Strength classes C20/25 to C50/60 according to EN 206-1:2000.
- Non-cracked concrete: M8 to M30, Rebar Ø8 to Ø32.
- Cracked concrete: M12 to M30, Rebar Ø12 to Ø32.

### Temperature Range:

- I: - 40 °C to +40 °C (max long term temperature +24 °C and max short term temperature +40 °C)
- II: - 40 °C to +80 °C (max long term temperature +50 °C and max short term temperature +80 °C)
- III: - 40 °C to +120 °C (max long term temperature +72 °C and max short term temperature +120 °C)

### Use conditions (Environmental conditions):

- Structures subject to dry internal conditions (zinc coated steel, stainless steel or high corrosion resistant steel).
- Structures subject to external atmospheric exposure (including industrial and marine environment) and to permanently damp internal condition, if no particular aggressive conditions exist (stainless steel or high corrosion resistant steel).
- Structures subject to external atmospheric exposure and to permanently damp internal condition, if other particular aggressive conditions exist (high corrosion resistant steel).

Note: Particular aggressive conditions are e.g. permanent, alternating immersion in seawater or the splash zone of seawater, chloride atmosphere of indoor swimming pools or atmosphere with extreme chemical pollution (e.g. in desulphurization plants or road tunnels where de-icing materials are used).

### Design:

- Verifiable calculation notes and drawings are prepared taking account of the loads to be anchored. The position of the anchor is indicated on the design drawings (e. g. position of the anchor relative to reinforcement or to supports, etc.).
- Anchorages are designed under the responsibility of an engineer experienced in anchorages and concrete work.
- Anchorages under static or quasi-static actions are designed in accordance with:
  - EOTA Technical Report TR 029 "Design of bonded anchors", Edition September 2010 or
  - CEN/TS 1992-4:2009
- Anchorages under seismic actions are designed in accordance with:
  - EOTA Technical Report TR 045 "Design of Metal Anchors under Seismic Action", Edition February 2013
  - Anchorages shall be positioned outside of critical regions (e.g. plastic hinges) of the concrete structure.
  - Fastenings in stand-off installation or with a grout layer are not allowed.

### Installation:

- Dry or wet concrete: M8 to M30, Rebar Ø8 to Ø32.
- Flooded holes (not sea water): M8 to M16, Rebar Ø8 to Ø16.
- Hole drilling by hammer or compressed air drill mode.
- Overhead installation allowed.
- Anchor installation carried out by appropriately qualified personnel and under the supervision of the person responsible for technical matters of the site.

Injection system GEBOFIX PRO VE-SF, GEBOFIX PRO VE-SF NORDIC for concrete

Intended Use  
Specifications

Annex B1

**Table B1: Installation parameters for threaded rod**

Anchor size		M 8	M 10	M 12	M 16	M 20	M 24	M 27	M 30	
Nominal drill hole diameter	$d_0$ [mm] =	10	12	14	18	24	28	32	35	
Effective anchorage depth	$h_{ef,min}$ [mm] =	60	60	70	80	90	96	108	120	
	$h_{ef,max}$ [mm] =	160	200	240	320	400	480	540	600	
Diameter of clearance hole in the fixture	$d_f$ [mm] ≤	9	12	14	18	22	26	30	33	
Diameter of steel brush	$d_b$ [mm] ≥	12	14	16	20	26	30	34	37	
Torque moment	$T_{inst}$ [Nm] ≤	10	20	40	80	120	160	180	200	
Thickness of fixture	$t_{fix,min}$ [mm] >	0								
	$t_{fix,max}$ [mm] <	1500								
Minimum thickness of member	$h_{min}$ [mm]	$h_{ef} + 30$ mm ≥ 100 mm			$h_{ef} + 2d_0$					
Minimum spacing	$s_{min}$ [mm]	40	50	60	80	100	120	135	150	
Minimum edge distance	$c_{min}$ [mm]	40	50	60	80	100	120	135	150	

**Table B2: Installation parameters for rebar**





Rebar size		Ø 8	Ø 10	Ø 12	Ø 14	Ø 16	Ø 20	Ø 25	Ø 28	Ø 32
Nominal drill hole diameter	$d_0$ [mm] =	12	14	16	18	20	24	32	35	40
Effective anchorage depth	$h_{ef,min}$ [mm] =	60	60	70	75	80	90	100	112	128
	$h_{ef,max}$ [mm] =	160	200	240	280	320	400	480	540	640
Diameter of steel brush	$d_b$ [mm] ≥	14	16	18	20	22	26	34	37	41,5
Minimum thickness of member	$h_{min}$ [mm]	$h_{ef} + 30$ mm ≥ 100 mm			$h_{ef} + 2d_0$					
Minimum spacing	$s_{min}$ [mm]	40	50	60	70	80	100	125	140	160
Minimum edge distance	$c_{min}$ [mm]	40	50	60	70	80	100	125	140	160

Injection system GEBOFIX PRO VE-SF, GEBOFIX PRO VE-SF NORDIC for concrete

Intended Use  
Installation parameters

**Annex B2**

**Table B3: Parameter cleaning and setting tools**

Anchor	Size (mm)	Nominal drill bit diameter $d_0$ (mm)	Steel Brush $d_b$ (mm)	Steel Brush (min brush diameter) $d_{b,min}$ (mm)	Piston plug
					
<b>Threaded Rod</b>  	M8	10,0	12,0	10,5	
	M10	12,0	14,0	12,5	
	M12	14,0	16,0	14,5	
	M16	18,0	20,0	18,5	
	M20	24,0	26,0	24,5	#24
	M24	28,0	30,0	28,5	#28
	M27	32,0	34,0	32,5	#32
	M30	35,0	37,0	35,5	#35
<b>Rebar</b>  	Ø8	12,0	14,0	12,5	
	Ø10	14,0	16,0	14,5	
	Ø12	16,0	18,0	16,5	
	Ø14	18,0	20,0	18,5	
	Ø16	20,0	22,0	20,5	
	Ø20	24,0	26,0	24,5	#24
	Ø25	32,0	34,0	32,5	#32
	Ø28	35,0	37,0	35,5	#35
	Ø32	40,0	41,5	40,5	#38

**Hand pump (volume 750 ml)**

Drill bit diameter ( $d_0$ ): 10 mm to 20 mm



**Compressed air tool (min 6 bar)**

Drill bit diameter ( $d_0$ ): 10 mm to 40 mm



**Injection system GEBOFIX PRO VE-SF, GEBOFIX PRO VE-SF NORDIC for concrete**

**Intended Use**

Cleaning and setting tools

**Annex B3**

## Installation instructions

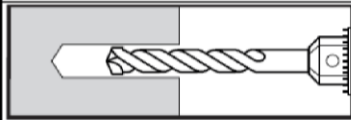

1. Drill with hammer drill a hole into the base material to the size and embedment depth required by the selected anchor (Table B1 or Table B2). In case of aborted drill hole: the drill hole shall be filled with mortar

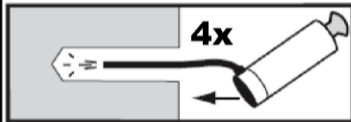

or

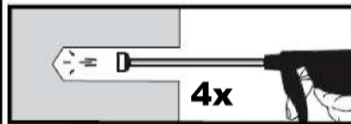

**Attention! Standing water in the bore hole must be removed before cleaning.**

- 2a. Starting from the bottom or back of the bore hole, blow the hole clean with compressed air (min. 6 bar) or a hand pump (Annex B3) a minimum of four times. If the bore hole ground is not reached an extension shall be used.

The hand-pump can **only** be used for anchor sizes in uncracked concrete up to bore hole diameter 20mm or embedment depth up to 240mm.

Compressed air (min. 6 bar) can be used for all sizes in cracked and uncracked concrete.

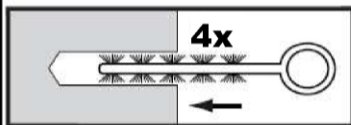

- 2b. Check brush diameter (Table B3) and attach the brush to a drilling machine or a battery screwdriver. Brush the hole with an appropriate sized wire brush  $> d_{b,min}$  (Table B3) a minimum of four times.

If the bore hole ground is not reached with the brush, a brush extension shall be used (Table B3).

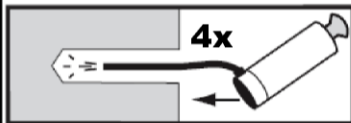

or

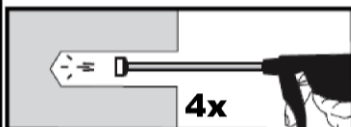

- 2c. Finally blow the hole clean again with compressed air or a hand pump (Annex B3) a minimum of four times. If the bore hole ground is not reached an extension shall be used.

The hand-pump can **only** be used for anchor sizes in uncracked concrete up to bore hole diameter 20mm or embedment depth up to 240mm.

Compressed air (min. 6 bar) can be used for all sizes in cracked and uncracked concrete.

**After cleaning, the bore hole has to be protected against re-contamination in an appropriate way, until dispensing the mortar in the bore hole. If necessary, the cleaning repeated has to be directly before dispensing the mortar.**

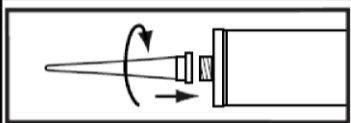

3. Attach a supplied static-mixing nozzle to the cartridge and load the cartridge into the correct dispensing tool. Cut off the foil tube clip before use. For every working interruption longer than the recommended working time (Table B4 and B5) as well as for new cartridges, a new static-mixer shall be used.

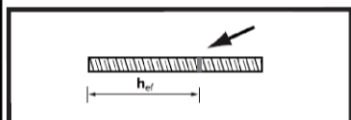

4. Prior to inserting the anchor rod into the filled bore hole, the position of the embedment depth shall be marked on the anchor rods.

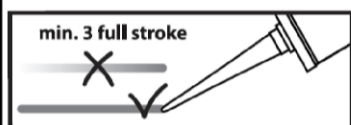

5. Prior to dispensing into the anchor hole, squeeze out separately a minimum of three full strokes and discard non-uniformly mixed adhesive components until the mortar shows a consistent colour. For foil tube cartridges is must be discarded a minimum of six full strokes.

Injection system GEBOFIX PRO VE-SF, GEBOFIX PRO VE-SF NORDIC for concrete

Intended use  
Installation instructions

Annex B4

### Installation instructions (continuation)

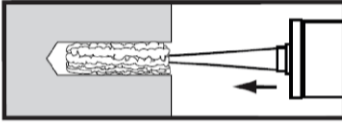

6. Starting from the bottom or back of the cleaned anchor hole fill the hole up to approximately two-thirds with adhesive. Slowly withdraw the static mixing nozzle as the hole fills to avoid creating air pockets. For embedment larger than 190 mm an extension nozzle shall be used. For overhead and horizontal installation in bore holes a piston plug and extension nozzle according to Annex B3 shall be used. Observe the gel-/ working times given in Table B4 and B5.

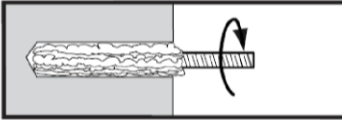

7. Push the threaded rod or reinforcing bar into the anchor hole while turning slightly to ensure positive distribution of the adhesive until the embedment depth is reached. The anchor should be free of dirt, grease, oil or other foreign material.

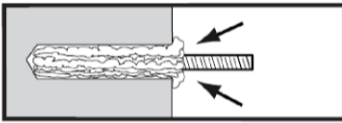

8. Be sure that the anchor is fully seated at the bottom of the hole and that excess mortar is visible at the top of the hole. If these requirements are not maintained, the application has to be renewed. For overhead application the anchor rod should be fixed (e.g. wedges).

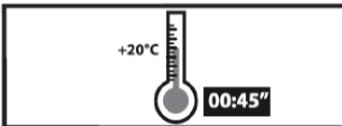

9. Allow the adhesive to cure to the specified time prior to applying any load or torque. Do not move or load the anchor until it is fully cured (attend Table B4 and B5).

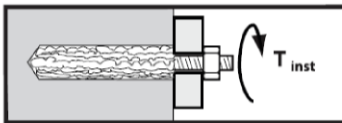

10. After full curing, the add-on part can be installed with the max. torque (Table B1) by using a calibrated torque wrench.

Injection system GEBOFIX PRO VE-SF, GEBOFIX PRO VE-SF NORDIC for concrete

Intended Use  
Installation instructions

Annex B5

**Table B4: Minimum curing time - GEBOFIX PRO VE-SF**

Base material temperature	Gel time (working time)	Minimum curing time in dry concrete <sup>2)</sup>
-10 °C to -6°C	90 min <sup>1)</sup>	24 h <sup>1)</sup>
-5 °C to -1°C	90 min	14 h
0 °C to +4°C	45 min	7 h
+5 °C to +9°C	25 min	2 h
+ 10 °C to +19°C	15 min	80 min
+ 20 °C to +29°C	6 min	45 min
+ 30 °C to +34°C	4 min	25 min
+ 35 °C to +39°C	2 min	20 min
≥ + 40 °C	1,5 min	15 min
Cartridge temperature	+5°C to +40°C	

<sup>1)</sup> Cartridge temperature **must** be at min. +15°C

<sup>2)</sup> In wet concrete the curing time **must** be doubled.

**Table B5: Minimum curing time - GEBOFIX PRO VE-SF NORDIC**

Base material temperature	Gel time (working time)	Minimum curing time in dry concrete <sup>1)</sup>
-20 °C to -16°C	75 min	24 h
-15 °C to -11°C	55 min	16 h
-10 °C to -6°C	35 min	10 h
-5 °C to -1°C	20 min	5 h
0 °C to +4°C	10 min	2,5 h
+5 °C to +9°C	6 min	80 Min
+ 10 °C	6 min	60 Min
Cartridge temperature	-20°C to +10°C	

<sup>1)</sup> In wet concrete the curing time **must** be doubled.

Injection system GEBOFIX PRO VE-SF, GEBOFIX PRO VE-SF NORDIC for concrete

Intended Use  
Curing time

**Annex B6**

**Table C1: Characteristic values of resistance for threaded rods under tension loads in non-cracked concrete**

Anchor size threaded rod			M 8	M 10	M 12	M 16	M 20	M 24	M 27	M 30	
<b>Steel failure</b>											
Characteristic tension resistance		$N_{Rk,s}$	[kN]	$A_s \times f_{uk}$							
<b>Combined pull-out and concrete failure</b>											
Characteristic bond resistance in non-cracked concrete C20/25											
Temperature range I: 40°C/24°C	dry and wet concrete	$\tau_{Rk,ucr}$	[N/mm <sup>2</sup> ]	8,5	10,0	10,0	10,0	10,0	9,5	8,5	7,5
	flooded bore hole	$\tau_{Rk,ucr}$	[N/mm <sup>2</sup> ]	6,0	7,5	7,5	7,5	No Performance Determined (NPD)			
Temperature range II: 80°C/50°C	dry and wet concrete	$\tau_{Rk,ucr}$	[N/mm <sup>2</sup> ]	6,5	7,5	7,5	7,5	7,5	7,0	6,5	5,5
	flooded bore hole	$\tau_{Rk,ucr}$	[N/mm <sup>2</sup> ]	4,5	5,5	5,5	5,5	No Performance Determined (NPD)			
Temperature range III: 120°C/72°C	dry and wet concrete	$\tau_{Rk,ucr}$	[N/mm <sup>2</sup> ]	4,5	5,5	5,5	5,5	5,5	5,5	4,5	4,0
	flooded bore hole	$\tau_{Rk,ucr}$	[N/mm <sup>2</sup> ]	3,5	4,0	4,0	4,0	No Performance Determined (NPD)			
Increasing factors for concrete $\psi_c$		C30/37		1,04							
		C40/50		1,08							
		C50/60		1,10							
Factor according to CEN/TS 1992-4-5 Section 6.2.2.3		$k_B$	[-]	10,1							
<b>Concrete cone failure</b>											
Factor according to CEN/TS 1992-4-5 Section 6.2.3.1		$k_{ucr}$	[-]	10,1							
Edge distance		$c_{cr,N}$	[mm]	1,5 $h_{ef}$							
Axial distance		$s_{cr,N}$	[mm]	3,0 $h_{ef}$							
<b>Splitting failure</b>											
Edge distance $c_{cr,sp}$ [mm] for		$h / h_{ef} \geq 2,0$		1,0 $h_{ef}$							
		$2,0 > h / h_{ef} > 1,3$		4,6 $h_{ef} - 1,8 h$							
		$h / h_{ef} \leq 1,3$		2,26 $h_{ef}$							
Axial distance		$s_{cr,sp}$	[mm]	2 $c_{cr,sp}$							
Installation safety factor (dry and wet concrete)		$\gamma_2 = \gamma_{inst}$		1,0	1,2						
Installation safety factor (flooded bore hole)		$\gamma_2 = \gamma_{inst}$		1,4				No Performance Determined (NPD)			

electronic copy of the eta by dibt: eta-09/0078

**Injection system GEBOFIX PRO VE-SF, GEBOFIX PRO VE-SF NORDIC for concrete**

**Performances**

Characteristic values of resistance for threaded rods under tension loads in non-cracked concrete

**Annex C1**

**Table C2: Characteristic values of resistance for threaded rods under tension loads in cracked concrete**

Anchor size threaded rod			M 12	M 16	M 20	M24	M27	M30	
<b>Steel failure</b>									
Characteristic tension resistance		$N_{Rk,s}=N_{Rk,s,seis,C1}$	[kN]	$A_s \times f_{uk}$					
<b>Combined pull-out and concrete failure</b>									
Characteristic bond resistance in cracked concrete C20/25									
Temperature range I: 40°C/24°C	dry and wet concrete	$\tau_{Rk,cr}$	[N/mm <sup>2</sup> ]	4,5	4,5	4,5	4,5	5,0	5,0
		$\tau_{Rk,seis,C1}$	[N/mm <sup>2</sup> ]	3,1	3,1	3,1	3,1	3,5	3,5
	flooded bore hole	$\tau_{Rk,cr}$	[N/mm <sup>2</sup> ]	4,5	4,5	No Performance Determined (NPD)			
		$\tau_{Rk,seis,C1}$	[N/mm <sup>2</sup> ]	3,1	3,1				
Temperature range II: 80°C/50°C	dry and wet concrete	$\tau_{Rk,cr}$	[N/mm <sup>2</sup> ]	3,0	3,0	3,0	3,0	4,0	4,0
		$\tau_{Rk,seis,C1}$	[N/mm <sup>2</sup> ]	2,0	2,0	2,0	2,1	2,8	2,8
	flooded bore hole	$\tau_{Rk,cr}$	[N/mm <sup>2</sup> ]	3,0	3,0	No Performance Determined (NPD)			
		$\tau_{Rk,seis,C1}$	[N/mm <sup>2</sup> ]	2,0	2,0				
Temperature range II: 120°C/72°C	dry and wet concrete	$\tau_{Rk,cr}$	[N/mm <sup>2</sup> ]	2,5	2,5	2,5	2,5	3,0	3,0
		$\tau_{Rk,seis,C1}$	[N/mm <sup>2</sup> ]	1,7	1,7	1,7	1,7	2,1	2,1
	flooded bore hole	$\tau_{Rk,cr}$	[N/mm <sup>2</sup> ]	2,5	2,5	No Performance Determined (NPD)			
		$\tau_{Rk,seis,C1}$	[N/mm <sup>2</sup> ]	1,7	1,7				
Increasing factors for concrete $\psi_c$		C30/37		1,04					
		C40/50		1,08					
		C50/60		1,10					
Factor according to CEN/TS 1992-4-5 Section 6.2.2.3		$k_8$	[-]	7,2					
<b>Concrete cone failure</b>									
Factor according to CEN/TS 1992-4-5 Section 6.2.3.1		$k_{cr}$	[-]	7,2					
Edge distance		$c_{cr,N}$	[mm]	1,5 $h_{ef}$					
Axial distance		$s_{cr,N}$	[mm]	3,0 $h_{ef}$					
Installation safety factor (dry and wet concrete)		$\gamma_2 = \gamma_{inst}$		1,2					
Installation safety factor (flooded bore hole)		$\gamma_2 = \gamma_{inst}$		1,4	No Performance Determined (NPD)				

**Injection system GEBOFIX PRO VE-SF, GEBOFIX PRO VE-SF NORDIC for concrete**

**Performances**

Characteristic values of resistance for threaded rods under tension loads in cracked concrete

**Annex C2**



**Table C3: Characteristic values of resistance for threaded rods under shear loads in cracked and non-cracked concrete**

Anchor size threaded rod		M 8	M 10	M 12	M 16	M 20	M24	M 27	M 30	
<b>Steel failure without lever arm</b>										
Characteristic shear resistance	$V_{Rk,s}$	[kN]	$0,50 \times A_s \times f_{uk}$							
	$V_{Rk,s,seis,C1}$	[kN]	No Performance Determined (NPD)	$0,35 \times A_s \times f_{uk}$						
Ductility factor according to CEN/TS 1992-4-5 Section 6.3.2.1	$k_2$		0,8							
<b>Steel failure with lever arm</b>										
Characteristic bending moment	$M_{Rk,s}^0$	[Nm]	$1,2 \cdot W_{el} \cdot f_{uk}$							
	$M_{Rk,s,seis,C1}^0$	[Nm]	No Performance Determined (NPD)							
<b>Concrete pry-out failure</b>										
Factor in equation (5.7) of Technical Report TR 029 Factor in equation (27) of CEN/TS 1992-4-5 Section 6.3.3	$k_{(3)}$		2,0							
Installation safety factor	$\gamma_2 = \gamma_{inst}$		1,0							
<b>Concrete edge failure<sup>3)</sup></b>										
Effective length of anchor	$l_f$	[mm]	$l_f = \min(h_{ef}; 8 d_{nom})$							
Outside diameter of anchor	$d_{nom}$	[mm]	8	10	12	16	20	24	27	30
Installation safety factor	$\gamma_2 = \gamma_{inst}$		1,0							

**Injection system GEBOFIX PRO VE-SF, GEBOFIX PRO VE-SF NORDIC for concrete**

**Performances**

Characteristic values of resistance for threaded rods under shear loads in cracked and non-cracked concrete

**Annex C3**

**Table C4: Characteristic values of resistance for rebar under tension loads in non-cracked concrete**

Anchor size reinforcing bar				Ø 8	Ø 10	Ø 12	Ø 14	Ø 16	Ø 20	Ø 25	Ø 28	Ø 32	
<b>Steel failure</b>													
Characteristic tension resistance		$N_{Rk,s}$	[kN]	$A_s \times f_{yk}$									
<b>Combined pull-out and concrete failure</b>													
Characteristic bond resistance in non-cracked concrete C20/25													
Temperature range I: 40°C/24°C	dry and wet concrete	$\tau_{Rk,ucr}$	[N/mm <sup>2</sup> ]	8,5	10	10	10	10	10	9,0	8,0	7,0	
	flooded bore hole	$\tau_{Rk,ucr}$	[N/mm <sup>2</sup> ]	6,0	7,5	7,5	7,5	7,5	No Performance Determined (NPD)				
Temperature range II: 80°C/50°C	dry and wet concrete	$\tau_{Rk,ucr}$	[N/mm <sup>2</sup> ]	6,5	7,5	7,5	7,5	7,5	7,5	7,0	6,0	5,0	
	flooded bore hole	$\tau_{Rk,ucr}$	[N/mm <sup>2</sup> ]	4,5	5,5	5,5	5,5	5,5	No Performance Determined (NPD)				
Temperature range III: 120°C/72°C	dry and wet concrete	$\tau_{Rk,ucr}$	[N/mm <sup>2</sup> ]	4,5	5,5	5,5	5,5	5,5	5,5	5,0	4,5	3,5	
	flooded bore hole	$\tau_{Rk,ucr}$	[N/mm <sup>2</sup> ]	3,5	4,0	4,0	4,0	4,0	No Performance Determined (NPD)				
Increasing factors for concrete $\psi_c$		C30/37		1,04									
		C40/50		1,08									
		C50/60		1,10									
Factor according to CEN/TS 1992-4-5 Section 6.2.2.3		$k_8$	[-]	10,1									
<b>Concrete cone failure</b>													
Factor according to CEN/TS 1992-4-5 Section 6.2.3.1		$k_{ucr}$	[-]	10,1									
Edge distance		$c_{cr,N}$	[mm]	1,5 $h_{ef}$									
Axial distance		$s_{cr,N}$	[mm]	3,0 $h_{ef}$									
<b>Splitting failure</b>													
Edge distance $c_{cr,sp}$ [mm] for		$h / h_{ef} \geq 2,0$		1,0 $h_{ef}$									
		$2,0 > h / h_{ef} > 1,3$		4,6 $h_{ef}$ - 1,8 h									
		$h / h_{ef} \leq 1,3$		2,26 $h_{ef}$									
Axial distance		$s_{cr,sp}$	[mm]	2 $c_{cr,sp}$									
Partial safety factor (dry and wet concrete)		$\gamma_2 = \gamma_{inst}$		1,0	1,2								
Partial safety factor (flooded bore hole)		$\gamma_2 = \gamma_{inst}$		1,4						No Performance Determined (NPD)			

Injection system GEBOFIX PRO VE-SF, GEBOFIX PRO VE-SF NORDIC for concrete

**Performances**  
Characteristic values of resistance for rebar under tension loads in non-cracked concrete

**Annex C4**

**Table C5: Characteristic values of resistance for rebar under tension loads in cracked concrete**

Anchor size reinforcing bar			Ø 12	Ø 14	Ø 16	Ø 20	Ø 25	Ø 28	Ø 32	
<b>Steel failure</b>										
Characteristic tension resistance	$N_{Rk,s}=N_{Rk,s,seis,C1}$	[kN]	$A_s \times f_{uk}$							
<b>Combined pull-out and concrete failure</b>										
Characteristic bond resistance in cracked concrete C20/25										
Temperature range I: 40°C/24°C	dry and wet concrete	$\tau_{Rk,cr}$	[N/mm <sup>2</sup> ]	4,5	4,5	4,5	4,5	4,5	5,0	5,0
		$\tau_{Rk,seis,C1}$	[N/mm <sup>2</sup> ]	3,1	3,1	3,1	3,1	3,1	3,5	3,5
	flooded bore hole	$\tau_{Rk,cr}$	[N/mm <sup>2</sup> ]	4,5	4,5	4,5	No Performance Determined (NPD)			
		$\tau_{Rk,seis,C1}$	[N/mm <sup>2</sup> ]	3,1	3,1	3,1				
Temperature range II: 80°C/50°C	dry and wet concrete	$\tau_{Rk,cr}$	[N/mm <sup>2</sup> ]	3,0	3,0	3,0	3,0	3,0	4,0	4,0
		$\tau_{Rk,seis,C1}$	[N/mm <sup>2</sup> ]	2,0	2,0	2,0	2,0	2,1	2,8	2,8
	flooded bore hole	$\tau_{Rk,cr}$	[N/mm <sup>2</sup> ]	3,0	3,0	3,0	No Performance Determined (NPD)			
		$\tau_{Rk,seis,C1}$	[N/mm <sup>2</sup> ]	2,0	2,0	2,0				
Temperature range II: 120°C/72°C	dry and wet concrete	$\tau_{Rk,cr}$	[N/mm <sup>2</sup> ]	2,5	2,5	2,5	2,5	2,5	3,0	3,0
		$\tau_{Rk,seis,C1}$	[N/mm <sup>2</sup> ]	1,7	1,7	1,7	1,7	1,7	2,1	2,1
	flooded bore hole	$\tau_{Rk,cr}$	[N/mm <sup>2</sup> ]	2,5	2,5	2,5	No Performance Determined (NPD)			
		$\tau_{Rk,seis,C1}$	[N/mm <sup>2</sup> ]	1,7	1,7	1,7				
Increasing factors for concrete $\psi_c$		C30/37		1,04						
		C40/50		1,08						
		C50/60		1,10						
Factor according to CEN/TS 1992-4-5 Section 6.2.2.3	$k_8$	[-]	7,2							
<b>Concrete cone failure</b>										
Factor according to CEN/TS 1992-4-5 Section 6.2.3.1	$k_{cr}$	[-]	7,2							
Edge distance	$c_{cr,N}$	[mm]	1,5 $h_{ef}$							
Axial distance	$s_{cr,N}$	[mm]	3,0 $h_{ef}$							
Installation safety factor (dry and wet concrete)	$\gamma_2 = \gamma_{inst}$		1,2							
Installation safety factor (flooded bore hole)	$\gamma_2 = \gamma_{inst}$		1,4			No Performance Determined (NPD)				

**Injection system GEBOFIX PRO VE-SF, GEBOFIX PRO VE-SF NORDIC for concrete**

**Performances**

Characteristic values of resistance for rebar under tension loads in cracked concrete

**Annex C5**

**Table C6: Characteristic values of resistance for rebar under shear loads in cracked and non-cracked concrete**

Anchor size reinforcing bar		Ø 8	Ø 10	Ø 12	Ø 14	Ø 16	Ø 20	Ø 25	Ø 28	Ø 32	
<b>Steel failure without lever arm</b>											
Characteristic shear resistance	$V_{Rk,s}$	[kN]	$0,50 \times A_s \times f_{uk}$								
	$V_{Rk,s,seis,C1}$	[kN]	$0,35 \times A_s \times f_{uk}$								
Ductility factor according to CEN/TS 1992-4-5 Section 6.3.2.1	$k_2$		0,8								
<b>Steel failure with lever arm</b>											
Characteristic bending moment	$M^0_{Rk,s}$	[Nm]	$1,2 \cdot W_{el} \cdot f_{uk}$								
	$M^0_{Rk,s,seis,C1}$	[Nm]	No Performance Determined (NPD)								
<b>Concrete pry-out failure</b>											
Factor in equation (5.7) of Technical Report TR 029 Factor in equation (27) of CEN/TS 1992-4-5 Section 6.3.3	$k_{(3)}$		2,0								
Installation safety factor	$\gamma_2 = \gamma_{inst}$		1,0								
<b>Concrete edge failure<sup>3)</sup></b>											
Effective length of anchor	$l_f$	[mm]	$l_f = \min(h_{ef}; 8 d_{nom})$								
Outside diameter of anchor	$d_{nom}$	[mm]	8	10	12	14	16	20	25	28	32
Installation safety factor	$\gamma_2 = \gamma_{inst}$		1,0								

**Injection system GEBOFIX PRO VE-SF, GEBOFIX PRO VE-SF NORDIC for concrete**

**Performances**  
Characteristic values of resistance for rebar under shear loads

**Annex C6**

**Table C7: Displacements under tension load<sup>1)</sup> (threaded rod)**

Anchor size threaded rod			M 8	M 10	M 12	M 16	M 20	M24	M 27	M 30	
<b>Non-cracked concrete C20/25</b>											
40°C/24°C	$\delta_{N0}$ -Factor	[mm/(N/mm <sup>2</sup> )]	0,021	0,023	0,026	0,031	0,036	0,041	0,045	0,049	
	$\delta_{N\infty}$ -Factor	[mm/(N/mm <sup>2</sup> )]	0,030	0,033	0,037	0,045	0,052	0,060	0,065	0,071	
80°C/50°C	$\delta_{N0}$ -Factor	[mm/(N/mm <sup>2</sup> )]	0,050	0,056	0,063	0,075	0,088	0,100	0,110	0,119	
	$\delta_{N\infty}$ -Factor	[mm/(N/mm <sup>2</sup> )]	0,072	0,081	0,090	0,108	0,127	0,145	0,159	0,172	
120°C/72°C	$\delta_{N0}$ -Factor	[mm/(N/mm <sup>2</sup> )]	0,050	0,056	0,063	0,075	0,088	0,100	0,110	0,119	
	$\delta_{N\infty}$ -Factor	[mm/(N/mm <sup>2</sup> )]	0,072	0,081	0,090	0,108	0,127	0,145	0,159	0,172	
<b>Cracked concrete C20/25</b>											
40°C/24°C	$\delta_{N0}$ -Factor	[mm/(N/mm <sup>2</sup> )]	No Performance Determined (NPD)				0,070				
	$\delta_{N\infty}$ -Factor	[mm/(N/mm <sup>2</sup> )]					0,105				
80°C/50°C	$\delta_{N0}$ -Factor	[mm/(N/mm <sup>2</sup> )]					0,170				
	$\delta_{N\infty}$ -Factor	[mm/(N/mm <sup>2</sup> )]					0,245				
120°C/72°C	$\delta_{N0}$ -Factor	[mm/(N/mm <sup>2</sup> )]					0,170				
	$\delta_{N\infty}$ -Factor	[mm/(N/mm <sup>2</sup> )]					0,245				

<sup>1)</sup> Calculation of the displacement

$$\delta_{N0} = \delta_{N0}\text{-factor} \cdot \tau; \quad \tau: \text{action bond stress for tension}$$

$$\delta_{N\infty} = \delta_{N\infty}\text{-factor} \cdot \tau;$$

**Table C8: Displacements under shear load<sup>1)</sup> (threaded rod)**

Anchor size threaded rod			M 8	M 10	M 12	M 16	M 20	M24	M 27	M 30
For non-cracked concrete C20/25										
All temperatures	$\delta_{V0}$ -Factor	[mm/(kN)]	0,06	0,06	0,05	0,04	0,04	0,03	0,03	0,03
	$\delta_{V\infty}$ -Factor	[mm/(kN)]	0,09	0,08	0,08	0,06	0,06	0,05	0,05	0,05
For cracked concrete C20/25										
All temperatures	$\delta_{V0}$ -Factor	[mm/(kN)]	No Performance Determined (NPD)		0,11	0,10	0,09	0,08	0,08	0,07
	$\delta_{V\infty}$ -Factor	[mm/(kN)]			0,17	0,15	0,14	0,13	0,12	0,10

<sup>1)</sup> Calculation of the displacement

$$\delta_{V0} = \delta_{V0}\text{-factor} \cdot V; \quad V: \text{action shear load}$$

$$\delta_{V\infty} = \delta_{V\infty}\text{-factor} \cdot V;$$

**Injection system GEBOFIX PRO VE-SF, GEBOFIX PRO VE-SF NORDIC for concrete**

**Performances**  
Displacements (threaded rods)

**Annex C7**

**Table C9: Displacements under tension load<sup>1)</sup> (rebar)**

Anchor size reinforcing bar			Ø 8	Ø 10	Ø 12	Ø 14	Ø 16	Ø 20	Ø 25	Ø 28	Ø 32	
<b>Non-cracked concrete C20/25</b>												
40°C/24°C	δ <sub>N0</sub> -Factor	[mm/(N/mm <sup>2</sup> )]	0,021	0,023	0,026	0,028	0,031	0,036	0,043	0,047	0,052	
	δ <sub>N∞</sub> -Factor	[mm/(N/mm <sup>2</sup> )]	0,030	0,033	0,037	0,041	0,045	0,052	0,061	0,071	0,075	
80°C/50°C	δ <sub>N0</sub> -Factor	[mm/(N/mm <sup>2</sup> )]	0,050	0,056	0,063	0,069	0,075	0,088	0,104	0,113	0,126	
	δ <sub>N∞</sub> -Factor	[mm/(N/mm <sup>2</sup> )]	0,072	0,081	0,090	0,099	0,108	0,127	0,149	0,163	0,181	
120°C/72°C	δ <sub>N0</sub> -Factor	[mm/(N/mm <sup>2</sup> )]	0,050	0,056	0,063	0,069	0,075	0,088	0,104	0,113	0,126	
	δ <sub>N∞</sub> -Factor	[mm/(N/mm <sup>2</sup> )]	0,072	0,081	0,090	0,099	0,108	0,127	0,149	0,163	0,181	
<b>Cracked concrete C20/25</b>												
40°C/24°C	δ <sub>N0</sub> -Factor	[mm/(N/mm <sup>2</sup> )]	No Performance Determined (NPD)					0,070				
	δ <sub>N∞</sub> -Factor	[mm/(N/mm <sup>2</sup> )]						0,105				
80°C/50°C	δ <sub>N0</sub> -Factor	[mm/(N/mm <sup>2</sup> )]						0,170				
	δ <sub>N∞</sub> -Factor	[mm/(N/mm <sup>2</sup> )]						0,245				
120°C/72°C	δ <sub>N0</sub> -Factor	[mm/(N/mm <sup>2</sup> )]						0,170				
	δ <sub>N∞</sub> -Factor	[mm/(N/mm <sup>2</sup> )]						0,245				

<sup>1)</sup> Calculation of the displacement

$$\delta_{N0} = \delta_{N0}\text{-factor} \cdot \tau; \quad \tau: \text{action bond stress for tension}$$

$$\delta_{N\infty} = \delta_{N\infty}\text{-factor} \cdot \tau;$$

**Table C10: Displacement under shear load<sup>1)</sup> (rebar)**

Anchor size reinforcing bar			Ø 8	Ø 10	Ø 12	Ø 14	Ø 16	Ø 20	Ø 25	Ø 28	Ø 32	
For non-cracked concrete C20/25												
All temperatures	δ <sub>V0</sub> -Factor	[mm/(kN)]	0,06	0,05	0,05	0,04	0,04	0,04	0,03	0,03	0,03	
	δ <sub>V∞</sub> -Factor	[mm/(kN)]	0,09	0,08	0,08	0,06	0,06	0,05	0,05	0,04	0,04	
For cracked concrete C20/25												
All temperatures	δ <sub>V0</sub> -Factor	[mm/(kN)]	No Performance Determined (NPD)			0,11	0,11	0,10	0,09	0,08	0,07	0,06
	δ <sub>V∞</sub> -Factor	[mm/(kN)]				0,17	0,16	0,15	0,14	0,12	0,11	0,10

<sup>1)</sup> Calculation of the displacement

$$\delta_{V0} = \delta_{V0}\text{-factor} \cdot V; \quad V: \text{action shear load}$$

$$\delta_{V\infty} = \delta_{V\infty}\text{-factor} \cdot V;$$

**Injection system GEBOFIX PRO VE-SF, GEBOFIX PRO VE-SF NORDIC for concrete**

**Performances**  
Displacements (rebar)

**Annex C8**