

Approval body for construction products
and types of construction

Bautechnisches Prüfamt

An institution established by the Federal and
Laender Governments



European Technical Assessment

ETA-13/1038
of 10 May 2016

English translation prepared by DIBt - Original version in German language

General Part

Technical Assessment Body issuing the
European Technical Assessment:

Deutsches Institut für Bautechnik

Trade name of the construction product

Hilti screw anchor HUS3

Product family
to which the construction product belongs

Concrete screw for use in concrete

Manufacturer

Hilti Aktiengesellschaft
9494 SCHAAN
FÜRSTENTUM LIECHTENSTEIN

Manufacturing plant

Hilti Werke

This European Technical Assessment
contains

24 pages including 3 annexes which form an integral part
of this assessment

This European Technical Assessment is
issued in accordance with Regulation (EU)
No 305/2011, on the basis of

Guideline for European technical approval of "Metal
anchors for use in concrete", ETAG 001 Part 3: "Undercut
anchors", April 2013, used as European Assessment
Document (EAD) according to Article 66 Paragraph 3 of
Regulation (EU) No 305/2011 and European Assessment
Document (EAD) 330011-00-0601 "Assessment of
adjustable concrete screws", July 2014.

This version replaces

ETA-13/1038 issued on 29 January 2016

The European Technical Assessment is issued by the Technical Assessment Body in its official language. Translations of this European Technical Assessment in other languages shall fully correspond to the original issued document and shall be identified as such.

Communication of this European Technical Assessment, including transmission by electronic means, shall be in full. However, partial reproduction may only be made with the written consent of the issuing Technical Assessment Body. Any partial reproduction shall be identified as such.

This European Technical Assessment may be withdrawn by the issuing Technical Assessment Body, in particular pursuant to information by the Commission in accordance with Article 25(3) of Regulation (EU) No 305/2011.

Specific Part

1 Technical description of the product

The Hilti screw anchor HUS3 is an anchor made of galvanised steel (HUS3-H, HUS3-HF, HUS3-C, HUS3-P, HUS3-PS, HUS3-A, HUS3-I, HUS3-I Flex) of sizes 6, 8, 10 and 14. The anchor is screwed into a predrilled cylindrical drill hole. The special thread of the anchor cuts an internal thread into the member while setting. The anchorage is characterised by mechanical interlock in the special thread.

The product description is given in Annex A.

2 Specification of the intended use in accordance with the applicable European Assessment Document

The performances given in Section 3 are only valid if the anchor is used in compliance with the specifications and conditions given in Annex B.

The verifications and assessment methods on which this European Technical Assessment is based lead to the assumption of a working life of the anchor of at least 50 years. The indications given on the working life cannot be interpreted as a guarantee given by the producer, but are to be regarded only as a means for choosing the right products in relation to the expected economically reasonable working life of the works.

3 Performance of the product and references to the methods used for its assessment

3.1 Mechanical resistance and stability (BWR 1)

Wesentliches Merkmal	Leistung
Characteristic resistance under static and quasi-static loading	See Annex C1 – C3
Characteristic resistance under seismic loading Category C1	See Annex C4
Displacements for tension and shear loads	See Annex C8

3.2 Safety in case of fire (BWR 2)

Essential characteristic	Performance
Reaction to fire	Anchorage satisfy requirements for Class A1
Resistance to fire	See Annex C5 – C7

3.3 Safety in use (BWR 4)

The essential characteristics regarding Safety in use are included under the Basic Works Requirement Mechanical resistance and stability.

4 Assessment and verification of constancy of performance (AVCP) system applied, with reference to its legal base

In accordance with guideline for European technical approval ETAG 001, April 2013, used as European Assessment Document (EAD) according to Article 66 Paragraph 3 of Regulation (EU) No 305/2011, and European Assessment Document EAD 330011-00-0601 the applicable European legal act is: [96/582/EC].

The system to be applied is: 1

English translation prepared by DIBt

5 Technical details necessary for the implementation of the AVCP system, as provided for in the applicable European Assessment Document

Technical details necessary for the implementation of the AVCP system are laid down in the control plan deposited with Deutsches Institut für Bautechnik.

Issued in Berlin on 10 May 2016 by Deutsches Institut für Bautechnik

Uwe Bender
Head of Department

beglaubigt:
Baderschneider

Product and installed condition without adjustment

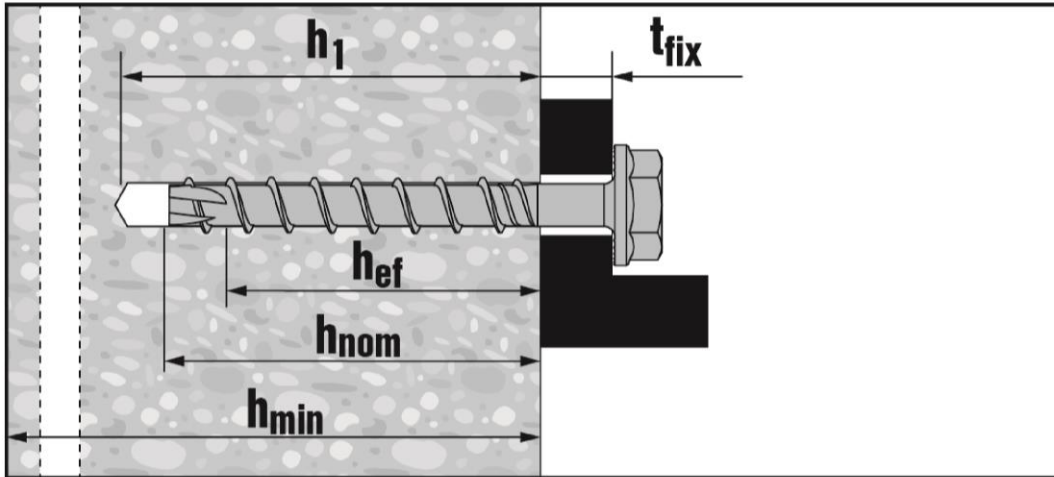

HUS3-H (hexagon head configuration sizes 6, 8, 10 and 14)

HUS3-HF (hexagon head configuration sizes 8, 10 and 14)

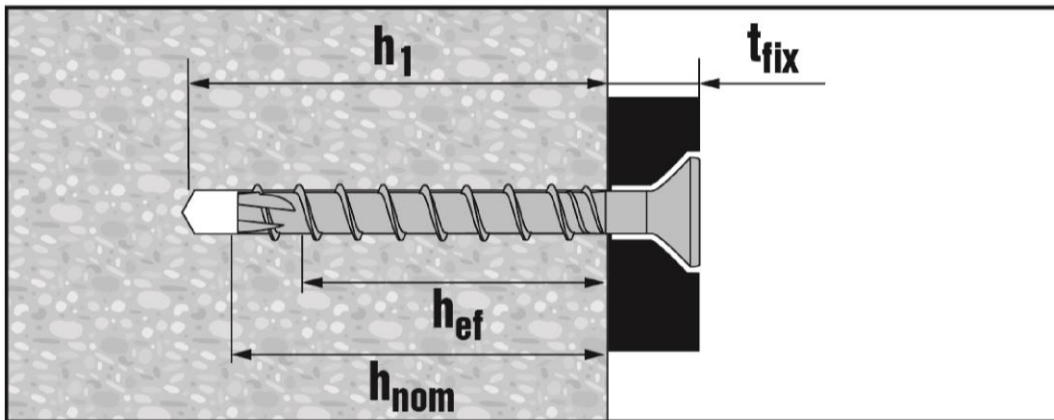

HUS3-C (countersunk head configuration sizes 6, 8 and 10)

electronic copy of the eta by dibt: eta-13/1038

Hilti Screw anchor HUS3

Product description
Installed condition without adjustment

Annex A1

Product and installed condition without adjustment

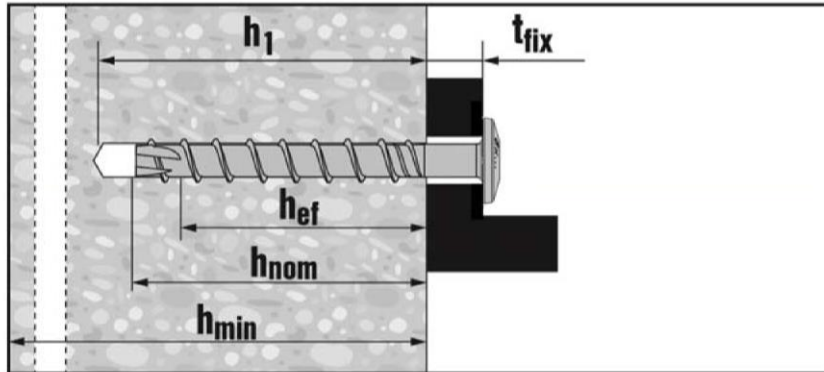

HUS3-P/PS (pan head configuration size 6)

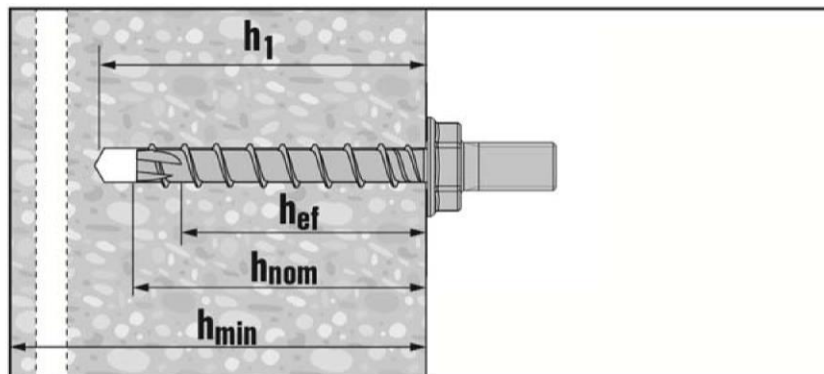

HUS3-A (size 6 with external thread configuration M8 or M10)

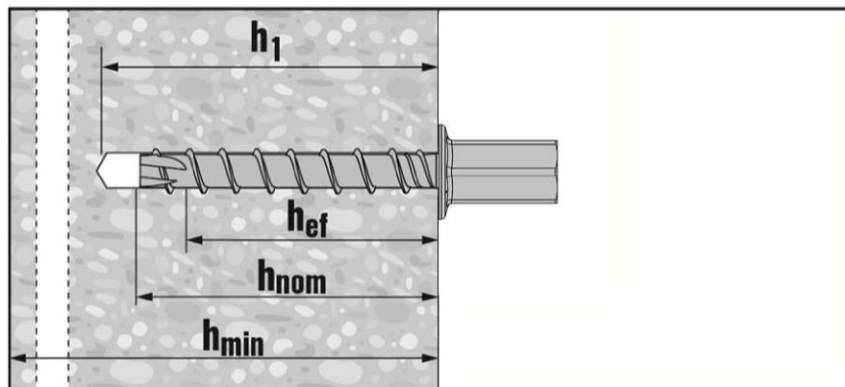

HUS3-I (size 6 with internal thread configuration M8/M10)

Hilti Screw anchor HUS3

Product description
Installed condition without adjustment

Annex A2

Product and installed condition with adjustment

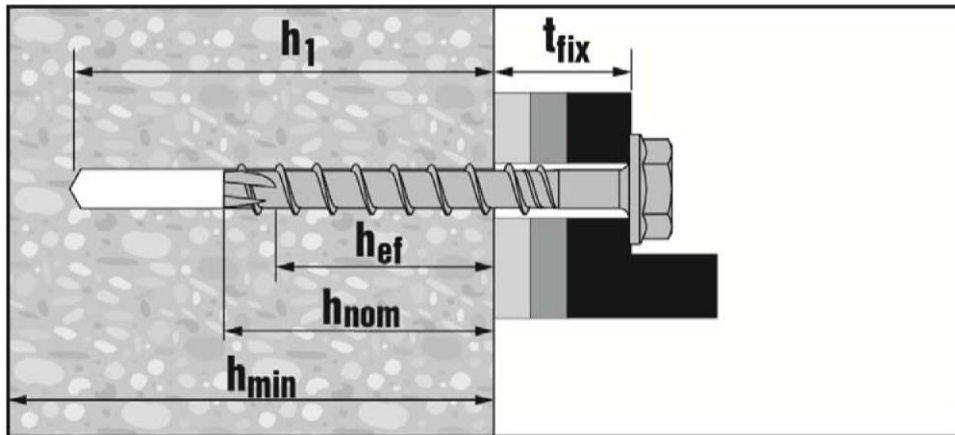

HUS3-H (hexagon head configuration sizes 8, 10 – h_{nom2} , h_{nom3})

HUS3-HF (hexagon head configuration sizes 8 and 10 – h_{nom2} , h_{nom3})

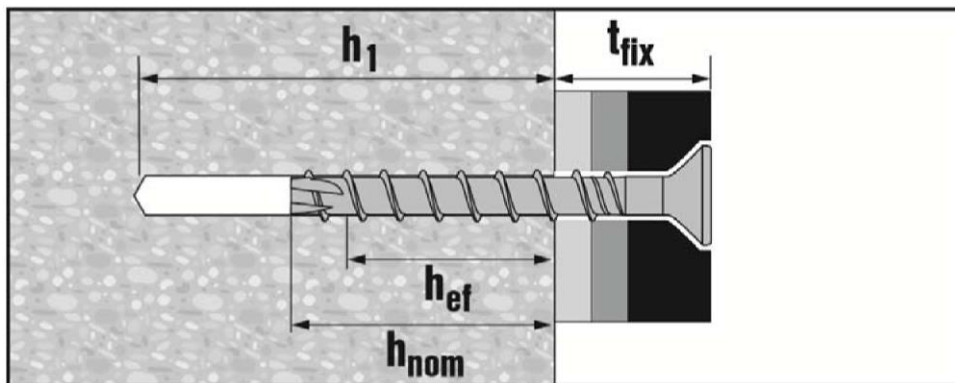

HUS3-C (countersunk head configuration sizes 8 and 10 – h_{nom2} , h_{nom3})



electronic copy of the eta by dibt: eta-13/1038

Hilti Screw anchor HUS3

Product description
Installed condition with adjustment

Annex A3

Table A1: Material and screw types

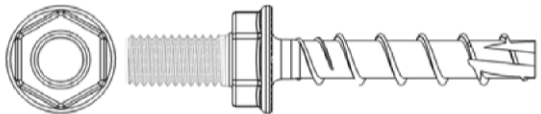
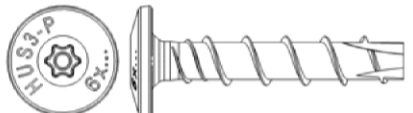
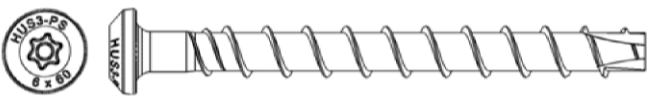
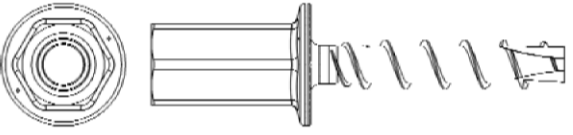
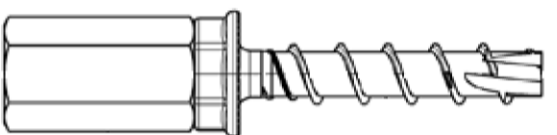
Part	Designation / Material						
1, 2,	Screw anchor / Carbon steel						
3, 4,	Anchor size HUS3						
5, 6,							6
7.	Characteristic yield strength	f_{yk}	[N/mm ²]	745	695	690	630
	Characteristic ultimate strength	f_{uk}	[N/mm ²]	930	810	805	730
	Elongation at rupture	A_5	[%]	≤8			
	1) Hilti HUS3-H, sizes 6, 8,10 and 14, hexagonal head configuration, galvanized 2) Hilti HUS3-HF, sizes 8,10 and 14, hexagonal head configuration, multilayer coating						
	3) Hilti HUS3-C, sizes 6, 8 and 10, countersunk head configuration, galvanized						
	4) Hilti HUS3-A, size 6, external thread M8/16 and M10/21, galvanized						
	5) Hilti HUS3-P, size 6, pan head configuration, galvanized						
	6) Hilti HUS3-PS, size6, pan head (small) configuration, galvanized						
	7) Hilti HUS3-I, size 6, internal thread M8 and M10, galvanized						
	8) Hilti HUS3-I Flex, size 6, galvanized, with external thread - M8/16 preassembled with coupler M6 or M8, - M10/21 preassembled with coupler M10 or M12.						

Hilti Screw anchor HUS3

Production description
Material and screw types

Annex A4

Table A2: Specification and marking

Anchor size HUS3			6		8			10			14		
Type			H, C, A, P, PS, I, I-Flex		H, HF, C			H, HF, C			H, HF		H
Nominal embedment depth [mm]			h_{nom}	h_{nom1}	h_{nom2}	h_{nom3}	h_{nom1}	h_{nom2}	h_{nom3}	h_{nom1}	h_{nom2}	h_{nom3}	
			55	50	60	70	55	75	85	65	85	115	
Threaded outer diameter	d_t	[mm]	7,85	10,30			12,40			16,85			
Core diameter	d_k	[mm]	5,85	7,85			9,90			12,95			
Shaft diameter	d_s	[mm]	6,15	8,45			10,55			13,80			
Stressed section	A_s	[mm ²]	26,9	48,4			77,0			131,7			

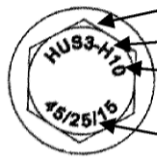
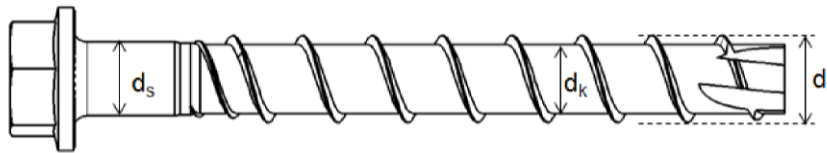

HUS3 : Hilti Universal Screw 3rd generation

H : Hexagonal head

10 : screw diameter

45/25/15 : maximum thickness fixture $t_{fix1}/t_{fix2}/t_{fix3}$ related to the embedment depth $h_{nom1}/h_{nom2}/h_{nom3}$ (see Annex B4 and B5)

Hilti Screw anchor HUS3

Production description
Material and screw types

Annex A5

Specifications of intended use

Anchorage subject to:

- Static and quasi-static loads: All sizes and all embedment depths.
- Seismic action for Performance Category C1:
 - HUS3-H sizes 8, 10 and 14, standard and maximum embedment depth (h_{nom2} and h_{nom3}).
 - HUS3-C and HUS3-HF sizes 8 and 10, standard and maximum embedment depth (h_{nom2} and h_{nom3}).
- Fire exposure: All sizes and all embedment depths.

Base materials:

- Reinforced or unreinforced normal weight concrete according to EN 206-1:2000,
- Strength classes C20/25 to C50/60 according to EN 206-1:2000,
- Non-cracked or cracked concrete: all sizes and all embedment depths.

Use conditions (Environmental conditions):

- Anchorages subject to dry internal conditions.

Design:

- Anchorages are designed under the responsibility of an engineer experienced in anchorages and concrete work.
- Verifiable calculation notes and drawings are prepared taking account of the loads to be anchored. The position of the anchor is indicated on the design drawings (e.g. position of the anchor relative to reinforcement or to supports, etc.).
- Anchorages under static or quasi-static actions are designed in accordance with:
 - ETAG 001, Annex C, design method A, Edition August 2010 or
 - CEN/TS 1992-4:2009, design method A
- Anchorages under seismic actions (cracked concrete) are designed in accordance with:
 - EOTA Technical Report TR 045, Edition February 2013
 - Anchorages shall be positioned outside of critical regions (e.g. plastic hinges) of the concrete structure
 - Fastenings in stand-off installation or with a grout layer are not allowed
- Anchorages under fire exposure are designed in accordance with:
 - ETAG 001, Annex C, design method A, Edition August 2010 and EOTA Technical Report TR 020, Edition May 2004 or
 - CEN/TS 1992-4: 2009, Annex D
 - It must be ensured that local spalling of the concrete cover does not occur

Installation:

- Hammer drilling only: all sizes and all embedment depths.
- Anchor installation carried out by appropriately qualified personnel and under the supervision of the person responsible for technical matters of the site.
- In case of aborted hole: new drilling at a minimum distance away of twice the depth of the aborted hole or smaller distance if the aborted hole is filled with high strength mortar and if under shear or oblique tension load it is not the direction of the load application.
- After installation further turning of the anchor must not be possible.
- The head of the anchor must be supported on the fixture and is not damaged.
- Adjustability according to Annex B7 for:
 - HUS3-H, HUS3-HF and HUS3-C size 8 ($h_{nom2} = 60$ mm and $h_{nom3}=70$ mm)
 - HUS3-H, HUS3-HF and HUS3-C size 10 ($h_{nom2} = 75$ mm and $h_{nom3}=85$ mm)

Hilti Screw anchor HUS3

Intended Use
Specifications

Annex B1

Table B1: Installation parameters HUS3-6

Anchor size HUS3			6				
Type			H	C	A	P- PS	I I-Flex
Nominal embedment depth		[mm]	55				
Nominal drill hole diameter	d_0	[mm]	6				
Cutting diameter of drill bit	$d_{cut} \leq$	[mm]	6,40				
Clearance hole diameter	$d_f \leq$	[mm]	9				
Wrench size (H, A, I-type)	SW	[mm]	13	-	13	-	13
Countersunk head diameter	d_h	[mm]	-	11,5	-		
Torx size (C, P, PS –type)	TX	-	-	30	-	30	-
Depth of drill hole in floor/ wall position	$h_1 \geq$	[mm]	65				
Depth of drill hole in ceiling position	$h_1 \geq$	[mm]	58				
Installation Torque	T_{inst}	[Nm]	25				
Setting tool ¹⁾	Strength class	C20/25 and >20/25	Hilti SIW 14 A or Hilti SIW 22 A or				

Table B2: Installation parameters HUS3-8, 10 and 14

Anchor size HUS3			8			10			14		
Type			H, HF, C			H, HF, C			H, HF		H
			h_{nom1}	h_{nom2}	h_{nom3}	h_{nom1}	h_{nom2}	h_{nom3}	h_{nom1}	h_{nom2}	h_{nom3}
Nominal embedment depth	h_{nom}	[mm]	50	60	70	55	75	85	65	85	115
Nominal drill hole diameter	d_0	[mm]	8			10			14		
Cutting diameter of drill bit	$d_{cut} \leq$	[mm]	8,45			10,45			14,50		
Clearance hole diameter	$d_f \leq$	[mm]	12			14			18		
Wrench size (H, HF-type)	SW	[mm]	13			15			21		
Diameter of countersunk head	d_h	[mm]	18			21			-		
Torx size (C-type)	TX	-	45			50			-		
Depth of drill hole	$h_1 \geq$	[mm]	60	70	80	65	85	95	75	95	125
Depth of drill hole (with adjustability setting process)	$h_1 \geq$	[mm]	-	80	90	-	95	105	-		
Setting tool ¹⁾	Strength class	C20/25	Hilti SIW 14 A or Hilti SIW 22 A or Hilti SIW 22 T-A			Hilti SIW 22 A or Hilti SIW 22 T-A			Hilti SIW 22 T-A		
		> C20/25	Hilti SIW 22 T-A								

¹⁾ Installation with other impact screw driver of equivalent power is possible

Hilti Screw anchor HUS3

Intended Use
Installation parameter

Annex B2

Table B3: Minimum thickness of concrete member, minimum edge distance and spacing HUS3-6

Anchor size HUS3			6
Nominal embedment depth	h_{nom}	[mm]	55
Minimum thickness of concrete member	h_{min}	[mm]	100
Cracked and non-cracked concrete	Minimum spacing	s_{min}	35
	Minimum edge distance	c_{min}	35

Table B4: Minimum thickness of concrete member, minimum edge distance and spacing HUS3-8, 10 und 14

Anchor size HUS3			8			10			14		
			h_{nom1}	h_{nom2}	h_{nom3}	h_{nom1}	h_{nom2}	h_{nom3}	h_{nom1}	h_{nom2}	h_{nom3}
Nominal embedment depth	h_{nom}	[mm]	50	60	70	55	75	85	65	85	115
Minimum thickness of concrete member	h_{min}	[mm]	100	100	120	100	130	140	120	160	200
Cracked and non-cracked concrete	Minimum spacing	s_{min}	40	50	50	50	50	60	60	75	75
	Minimum edge distance	c_{min}	50	50	50	50	50	60	60	75	75

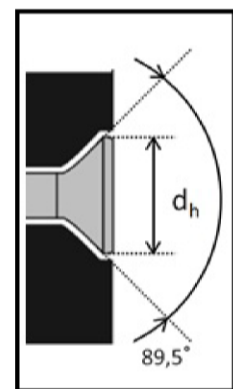
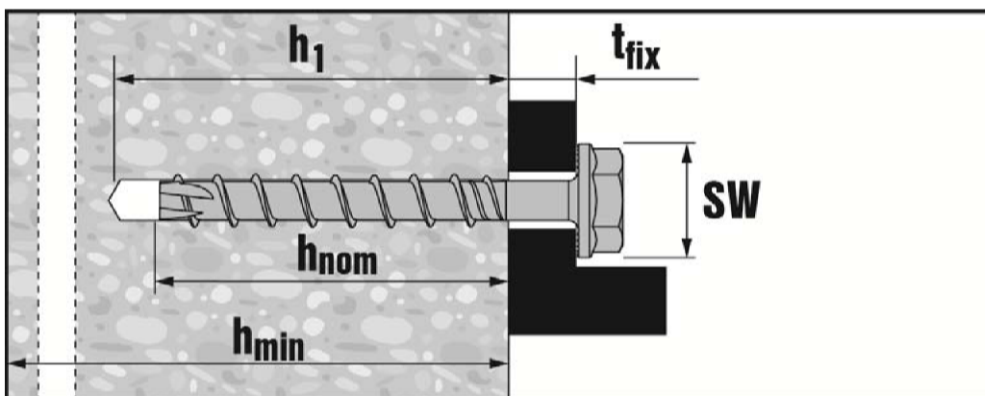

Hilti Screw anchor HUS3

Intended Use
Minimum thickness and minimum edge distance and spacing

Annex B3

Table B5: Screw length and maximum thickness of fixture for HUS3-6

Anchor size	6					
	H	C	A	I I-Flex	P	PS
embedment depth [mm]	55					
Length of screw [mm]	Thickness of fixture [mm]					
55			0	0		
60	5	5			5	5
70		15				
80	25				25	
100	45					
120	65					
135			80			
155			100			
175			120			
195			140			

Table B6: Screw length and maximum thickness of fixture for HUS3-C 8 and 10

Anchor size	8			10		
	h_{nom1}	h_{nom2}	h_{nom3}	h_{nom1}	h_{nom2}	h_{nom3}
Nominal embedment depth [mm]	50	60	70	55	75	85
Length of screw [mm]	Thickness of fixture [mm]					
	t_{fix1}	t_{fix2}	t_{fix3}	t_{fix1}	t_{fix2}	t_{fix3}
65	15	5	-	-	-	-
70	-	-	-	15	-	-
75	25	15	-	-	-	-
85	35	25	15	-	-	-
90	-	-	-	35	15	-
100	-	-	-	45	25	15

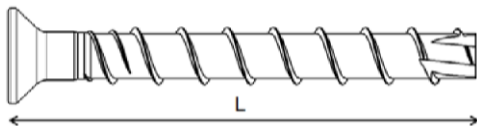

Hilti Screw anchor HUS3

Intended Use
Screw Length / thickness of fixture

Annex B4

Table B7: Screw length and maximum thickness of fixture for HUS3-H and HUS3-HF¹⁾

Anchor size	8			10			14		
	h_{nom1} 50	h_{nom2} 60	h_{nom3} 70	h_{nom1} 55	h_{nom2} 75	h_{nom3} 85	h_{nom1} 65	h_{nom2} 85	h_{nom3} 115
Nominal embedment depth [mm]	Thickness of fixture [mm]								
Length of screw [mm]	t_{fix1}	t_{fix2}	t_{fix3}	t_{fix1}	t_{fix2}	t_{fix3}	t_{fix1}	t_{fix2}	t_{fix3}
55	5	-	-	-	-	-	-	-	-
60	-	-	-	5	-	-	-	-	-
65	15	5	-	-	-	-	-	-	-
70	-	-	-	15	-	-	-	-	-
75	25	15	5	-	-	-	10	-	-
80	-	-	-	25	5	-	-	-	-
85	35	25	15	-	-	-	-	-	-
90	-	-	-	35	15	5	-	-	-
100	50	40	30	45	25	15	35	15	-
110	-	-	-	55	35	25	-	-	-
120	70	60	50	-	-	-	-	-	-
130	-	-	-	75	55	45	65	45	15
150	100	90	80	95	75	65	85	65	35

1) HUS3-HF available for size 14 with h_1 and h_2 only

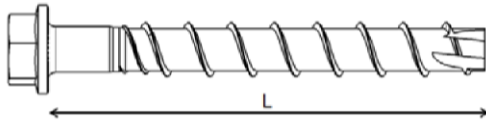

Hilti Screw anchor HUS3

Intended Use
Screw Length / thickness of fixture

Annex B5

Installation instruction without adjustment

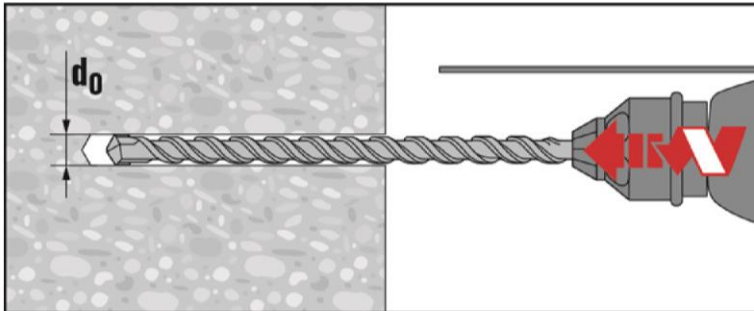

Make a cylindrical hole

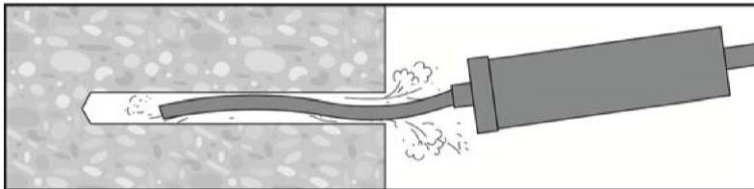

Clean the borehole

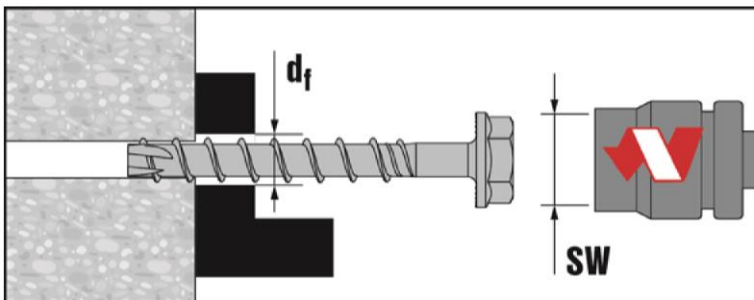

Install the screw anchor by impact screw driver (sizes 6, 8, 10 and 14)
or by torque wrench (size 6)

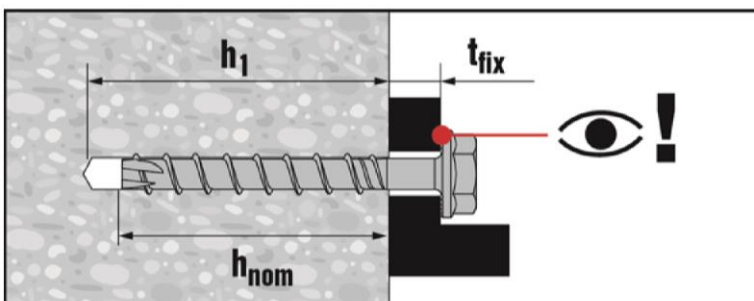
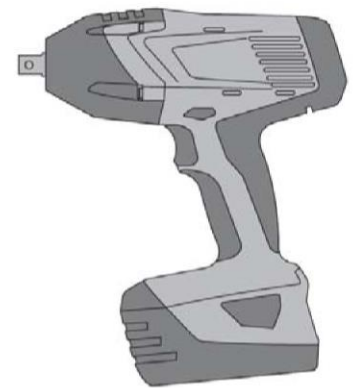

Ensure that the head of the anchor is fully supported on the fixture and it is not damaged.

Hilti Screw anchor HUS3

Intended Use

Installation Instruction without adjustment

Annex B6

Installation instruction with adjustment

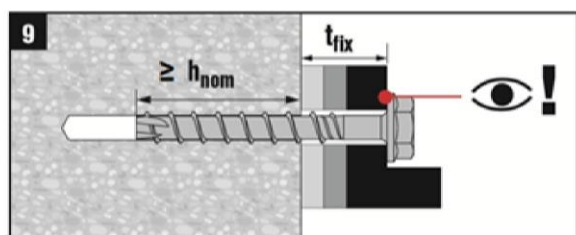
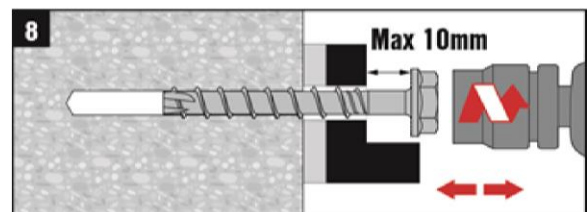
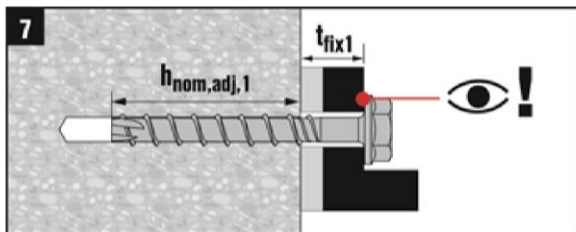
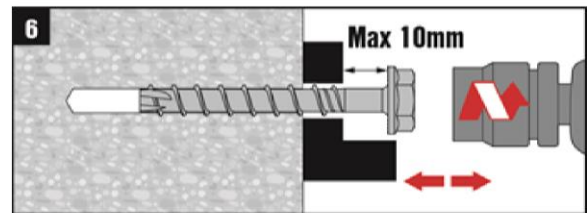
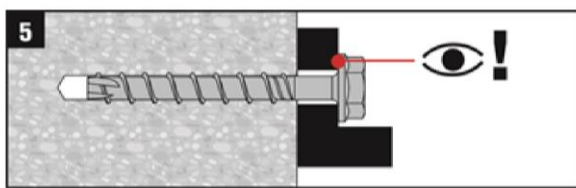
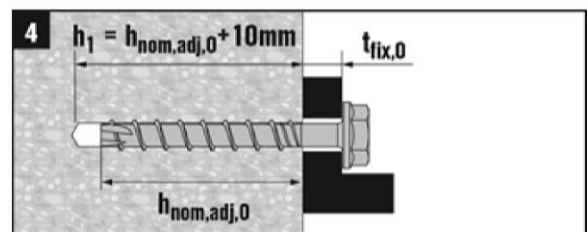
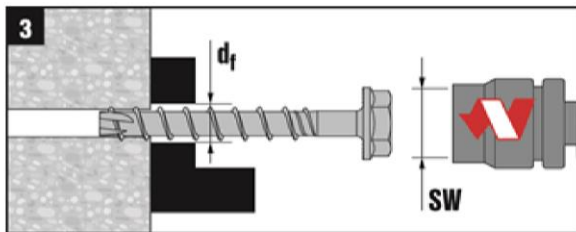
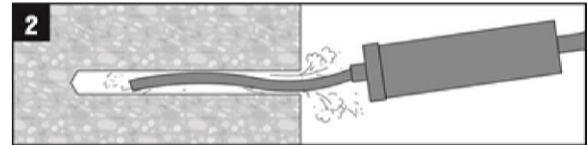
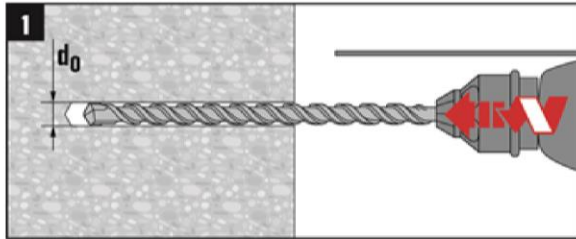

The anchor can be adjusted maximum two times.

The total allowed thickness of shims added during the adjustment process is 10mm.

The final embedment depth after adjustment process must be larger or equal than h_{nom2} or h_{nom3} .

Hilti Screw anchor HUS3

Intended Use
Installation instruction with adjustment

Annex B7

Table C1: Characteristic values for static and quasi-static action HUS3-6

Anchor size HUS3			6						
Type			H	C	A	I I-Flex	P	PS	
Nominal embedment depth	h_{nom}	[mm]	55						
Steel failure for tension and shear load									
Characteristic resistance	$N_{Rk,s}$	[kN]	24	22	24		21		
Partial safety factor	$\gamma_{Ms,N}$	[-]	1,4						
Characteristic resistance	$V_{Rk,s}$	[kN]	12,5						
Partial safety factor	$\gamma_{Ms,V}$	[-]	1,5						
k_2 factor	$k_2^{1)}$	[-]	0,8						
Characteristic resistance	$M_{Rk,s}^0$	[Nm]	21						
Pull-out failure									
Characteristic resistance in non-cracked concrete C20/25	$N_{Rk,p}$	[kN]	9				7,5		
Characteristic resistance in cracked concrete C20/25	$N_{Rk,p}$	[kN]	6						
Increasing factor concrete	C30/37	ψ_c	[-]	1,22					
	C40/50			1,41					
	C50/60			1,55					
Concrete cone and splitting failure									
Effective embedment depth	h_{ef}	[mm]	42						
Factor for	Cracked	$k_{cr}^{1)}$	[-]	7,2					
	Non-cracked	$k_{ucr}^{1)}$	[-]	10,1					
Concrete cone failure	Edge distance	$c_{cr,N}$	[mm]	$1,5 h_{ef}$					
	Spacing	$s_{cr,N}$	[mm]	$3 h_{ef}$					
Splitting failure	Edge distance	$c_{cr,sp}$	[mm]	63					
	Spacing	$s_{cr,sp}$	[mm]	126					
Installation safety factor	$\gamma_2^{2)} = \gamma_{inst}^{1)}$	[-]	1,2						
Concrete pry-out failure									
k factor	$K^{2)} = k_3^{1)}$	[-]	1,5						
Concrete edge failure									
Effective length of anchor	$l_f = h_{ef}$	[-]	42						
Outside diameter of anchor	d_{nom}	[mm]	6						

¹⁾ Parameters relevant only for design according to CEN/TS 1992-4:2009

²⁾ Parameter relevant only for design according to ETAG001 Annex C

Hilti Screw anchor HUS3

Performances

Characteristic values for static and quasi-static action

Annex C1

Table C2: Characteristic values for static and quasi-static action HUS3-8, 10 and 14

Anchor size HUS3			8			10			14		
			h_{nom1}	h_{nom2}	h_{nom3}	h_{nom1}	h_{nom2}	h_{nom3}	h_{nom1}	h_{nom2}	h_{nom3}
Nominal embedment depth	h_{nom}	[mm]	50	60	70	55	75	85	65	85	115
Adjustment											
Total max. thickness of adjustment layers	t_{adj}	[mm]	-	10	10	-	10	10	-	-	-
Max. number of adjustments	n_a	[-]	-	2	2	-	2	2	-	-	-
Steel failure for tension load											
Characteristic resistance	$N_{Rk,s}$	[kN]	39,2			62,2			96,6		
Partial safety factor	$\gamma_{Ms,N}$	[-]	1,4								
Pull-out failure											
Characteristic resistance in non-cracked concrete C20/25	$N_{Rk,p}$	[kN]	9	12	16	12	20	1)	1)	1)	1)
Characteristic resistance in cracked concrete C20/25	$N_{Rk,p}$	[kN]	6	9	12	1)	1)	1)	1)	1)	1)
Increasing factor concrete	C30/37	ψ_c	[-]	1,22							
	C40/50			1,41							
	C50/60			1,55							
Concrete cone and splitting failure											
Effective embedment depth	h_{ef}	[mm]	40	46,4	54,9	41,6	58,6	67,1	49,3	66,3	91,8
Factor for	Cracked	$k_{cr}^{2)}$	7,2								
	Non-cracked	$k_{ucr}^{2)}$	10,1								
Concrete cone failure	Edge distance	$c_{cr,N}$	$1,5 h_{ef}$								
	Spacing	$s_{cr,N}$	$3 h_{ef}$								
Splitting failure	Edge distance	$c_{cr,sp}$	60	70	85	65	90	110	85	100	140
	Spacing	$s_{cr,sp}$	120	140	170	130	180	220	170	200	280
Installation safety factor	$\gamma_2^{3)} = \gamma_{inst}^{2)}$	[-]	1,0								

1) Pull-out failure is not decisive

2) Parameters relevant only for design according to CEN/TS 1992-4:2009

3) Parameter relevant only for design according to ETAG001 Annex C

Hilti Screw anchor HUS3

Performances

Characteristic values for static and quasi-static action

Annex C2

Table C2 continued

Anchor size HUS3			8			10			14		
			h_{nom1}	h_{nom2}	h_{nom3}	h_{nom1}	h_{nom2}	h_{nom3}	h_{nom1}	h_{nom2}	h_{nom3}
Nominal embedment depth	h_{nom}	[mm]	50	60	70	55	75	85	65	85	115
Adjustment											
Total max. thickness of adjustment layers	t_{adj}	[mm]	-	10	10	-	10	10	-	-	-
Max. number of adjustments	n_a	[-]	-	2	2	-	2	2	-	-	-
Steel failure for shear load											
Characteristic resistance	$V_{Rk,s}$	[kN]	17			28			45		
Partial safety factor	$\gamma_{Ms,V}$	[-]				1,5					
k_2 factor	$k_2^{1)}$	[-]				0,8					
Characteristic resistance	$M^0_{Rk,s}$	[Nm]	46			92			187		
Concrete pry-out failure											
k factor	$K^{2)} = k_3^{1)}$	[-]	1,0	2,0		1,0			2,0		
Concrete edge failure											
Effective length of anchor	$l_f = h_{ef}$	[-]	40	46,4	54,9	41,6	58,6	67,1	49,3	66,3	91,8
Outside diameter of anchor	d_{nom}	[mm]	8			10			14		

¹⁾ Parameters relevant only for design according to CEN/TS 1992-4:2009

²⁾ Parameter relevant only for design according to ETAG001 Annex C

Hilti Screw anchor HUS3

Performances

Characteristic values for static and quasi-static action

Annex C3

Table C3: Characteristic values for seismic category C1

Anchor size HUS3			8		10		14	
			h_{nom2}	h_{nom3}	h_{nom2}	h_{nom3}	h_{nom2}	h_{nom3}
Nominal embedment depth	h_{nom}	[mm]	60	70	75	85	85	115
Steel failure for tension and shear load								
Characteristic resistance	$N_{Rk,s,seis}$	[kN]	39,2		62,2		96,6	
Partial safety factor	$\gamma_{Ms,N}$	[-]	1,4					
Characteristic resistance	$V_{Rk,s,seis}$	[kN]	11,9		16,8		22,5	
Partial safety factor	$\gamma_{Ms,V}$	[-]	1,5					
Pull-out failure								
Characteristic resistance in cracked concrete	$N_{Rk,p,seis}$	[kN]	9	12	1)	1)	1)	1)
Concrete cone failure								
Effective embedment depth	h_{ef}	[mm]	46,4	54,9	58,6	67,1	66,3	91,8
Concrete cone failure	Edge distance	$c_{cr,N}$	1,5 h_{ef}					
	Spacing	$s_{cr,N}$	3 h_{ef}					
Installation safety factor	γ_2	[-]	1,0					
Concrete pry-out failure								
k factor	k	[-]	2,0					
Concrete edge failure								
Effective length of anchor	$l_f = h_{ef}$	[-]	46,4	54,9	58,6	67,1	66,3	91,8
Outside diameter of anchor	d_{nom}	[mm]	8		10		14	

¹⁾ Pull-out failure is not decisive

Hilti Screw anchor HUS3

Performances

Characteristic values for seismic category C1

Annex C4

Table C4: Characteristic values for resistance to Fire

Anchor HUS3				6					
Type				H	C	A	I I-Flex	P	PS
Nominal embedment depth		h_{nom}	[mm]	55					
Steel failure for tension and shear load ($F_{Rk,s,fi} = N_{Rk,s,fi} = V_{Rk,s,fi}$)									
Characteristic resistance	R30	$F_{Rk,s,fi}$	[kN]	1,6					
	R60	$F_{Rk,s,fi}$	[kN]	1,2					
	R90	$F_{Rk,s,fi}$	[kN]	0,8					
	R120	$F_{Rk,s,fi}$	[kN]	0,7					
	R30	$M_{Rk,s,fi}^0$	[Nm]	1,4					
	R60	$M_{Rk,s,fi}^0$	[Nm]	1,1					
	R90	$M_{Rk,s,fi}^0$	[Nm]	0,7					
	R120	$M_{Rk,s,fi}^0$	[Nm]	0,6					
Pull-out failure									
Characteristic resistance	R30	$N_{Rk,p,fi}$	[kN]	1,5					
	R60								
	R90								
	R120	$N_{Rk,p,fi}$	[kN]	1,2					
Concrete cone failure									
Characteristic resistance	R30	$N_{Rk,c,fi}^0$	[kN]	1,8					
	R60								
	R90								
	R120	$N_{Rk,c,fi}^0$	[kN]	1,5					
Edge distance									
R30 to R120		$c_{cr,fi}$	[mm]	2 h_{ef}					
In case of fire attack from more than one side, the minimum edge distance shall be ≥ 300 mm.									
Anchor spacing									
R30 to R120		$s_{cr,fi}$	[mm]	2 $c_{cr,fi}$					
Concrete pry-out failure									
R30 to R120		k	[-]	1,5					
The anchorage depth has to be increased for wet concrete by at least 30 mm compared to the given value.									

Hilti Screw anchor HUS3

Performances

Characteristic values for resistance to fire

Annex C5

Table C5: Characteristic values for resistance to Fire

Anchor HUS3-H and HUS3-HF			8			10			14			
			h_{nom1}	h_{nom2}	h_{nom3}	h_{nom1}	h_{nom2}	h_{nom3}	h_{nom1}	h_{nom2}	h_{nom3}	
Nominal embedment depth	h_{nom}	[mm]	50	60	70	55	75	85	65	85	115	
Steel failure for tension and shear load ($F_{Rk,s,fi} = N_{Rk,s,fi} = V_{Rk,s,fi}$)												
Characteristic resistance	R30	$F_{Rk,s,fi}$	[kN]	3,2	3,5	3,8	6,1	6,2	10,4	10,6		
	R60	$F_{Rk,s,fi}$	[kN]	2,4	2,6	2,8	4,6	4,7	7,8	8,1		
	R90	$F_{Rk,s,fi}$	[kN]	1,6	1,6	1,9	3,1	3,2	5,3	5,5		
	R120	$F_{Rk,s,fi}$	[kN]	1,2	1,2	1,5	2,4	2,5	4,0	4,3		
	R30	$M^0_{Rk,s,fi}$	[Nm]	3,8	4,1	4,4	9,1	9,2	20,4	20,6		
	R60	$M^0_{Rk,s,fi}$	[Nm]	2,8	3,0	3,4	6,9	7,0	15,4	15,7		
	R90	$M^0_{Rk,s,fi}$	[Nm]	1,9	1,9	2,3	4,6	4,8	10,4	10,7		
	R120	$M^0_{Rk,s,fi}$	[Nm]	1,5	1,4	1,7	3,5	3,7	7,9	8,3		
Pull-out failure												
Characteristic resistance	R30 R60 R90	$N_{Rk,p,fi}$	[kN]	1,5	2,3	3,0	2,4	4,0	4,9	3,1	4,8	7,8
	R120	$N_{Rk,p,fi}$	[kN]	1,2	1,8	2,4	1,9	3,2	3,9	2,5	3,8	6,3
Concrete cone failure												
Characteristic resistance	R30 R60 R90	$N^0_{Rk,c,fi}$	[kN]	1,8	2,6	4,0	2,0	4,7	6,6	3,0	6,4	14,4
	R120	$N^0_{Rk,c,fi}$	[kN]	1,4	2,1	3,2	1,6	3,8	5,3	2,4	5,1	11,5
Edge distance												
R30 to R120	$c_{cr,fi}$	[mm]	2 h_{ef}									
In case of fire attack from more than one side, the minimum edge distance shall be ≥ 300 mm.												
Anchor spacing												
R30 to R120	$s_{cr,fi}$	[mm]	2 $c_{cr,fi}$									
Concrete pry-out failure												
R30 to R120	k	[-]	1,0	2,0	1,0	2,0						
The anchorage depth has to be increased for wet concrete by at least 30 mm compared to the given value.												

Hilti Screw anchor HUS3

Performances
Characteristic values for resistance to fire

Annex C6

Table C6: Characteristic values for resistance to Fire

Anchor HUS3-C				8			10		
				h_{nom1}	h_{nom2}	h_{nom3}	h_{nom1}	h_{nom2}	h_{nom3}
Nominal embedment depth h_{nom} [mm]				50	60	70	55	75	85
Steel failure for tension and shear load ($F_{Rk,s,fi} = N_{Rk,s,fi} = V_{Rk,s,fi}$)									
Characteristic resistance	R30	$F_{Rk,s,fi}$	[kN]	0,5			1,2		
	R60	$F_{Rk,s,fi}$	[kN]	0,4			1,0		
	R90	$F_{Rk,s,fi}$	[kN]	0,3			0,8		
	R120	$F_{Rk,s,fi}$	[kN]	0,2			0,6		
	R30	$M_{Rk,s,fi}^0$	[Nm]	0,6			1,7		
	R60	$M_{Rk,s,fi}^0$	[Nm]	0,5			1,5		
	R90	$M_{Rk,s,fi}^0$	[Nm]	0,4			1,1		
	R120	$M_{Rk,s,fi}^0$	[Nm]	0,3			0,9		
Pull-out failure									
Characteristic resistance	R30 R60 R90	$N_{Rk,p,fi}$	[kN]	1,5	2,3	3,0	2,4	4,0	5,0
	R120	$N_{Rk,p,fi}$	[kN]	1,2	1,8	2,4	1,9	3,2	4,0
Concrete cone failure									
Characteristic resistance	R30 R60 R90	$N_{Rk,c,fi}^0$	[kN]	1,8	2,6	4,0	2,0	4,7	6,6
	R120	$N_{Rk,c,fi}^0$	[kN]	1,5	2,1	3,2	1,6	3,8	5,3
Edge distance									
R30 to R120		$c_{cr,fi}$	[mm]	2 h_{ef}					
In case of fire attack from more than one side, the minimum edge distance shall be ≥ 300 mm.									
Anchor spacing									
R30 to R120		$s_{cr,fi}$	[mm]	2 $c_{cr,fi}$					
Concrete pry-out failure									
R30 to R120		k	[-]	1,0	2,0	1,0	2,0		
The anchorage depth has to be increased for wet concrete by at least 30 mm compared to the given value.									

Hilti Screw anchor HUS3

Performances
Characteristic values for resistance to fire

Annex C7

Table C7: Displacements under tension load HUS3-6

Anchor size HUS3				6	
Type				H, C, A, I	P, PS
Nominal embedment depth		h_{nom}	[mm]	55	
Cracked concrete C20/25 to C50/60	Tension Load	N	[kN]	2,4	
		δ_{N0}	[mm]	0,1	
	Displacement	$\delta_{N\infty}$	[mm]	0,6	
		$\delta_{N,seis}$	[mm]	-	
Non-cracked concrete C20/25 to C50/60	Tension Load	N	[kN]	3,6	3,0
		δ_{N0}	[mm]	0,2	
	Displacement	$\delta_{N\infty}$	[mm]	0,3	

Table C8: Displacements under tension load HUS3-8, 10, 14

Anchor size HUS3				8			10			14		
				h_{nom1}	h_{nom2}	h_{nom3}	h_{nom1}	h_{nom2}	h_{nom3}	h_{nom1}	h_{nom2}	h_{nom3}
Nominal embedment depth				50	60	70	55	75	85	65	85	115
Cracked concrete C20/25 to C50/60	Tension Load	N	[kN]	4,3	5,7	7,6	5,7	9,5	13,2	8,3	13,0	21,2
		δ_{N0}	[mm]	0,3	0,4	0,3	0,4	0,4	0,4	0,6	0,5	0,5
	Displacement	$\delta_{N\infty}$	[mm]	0,7	0,7	0,6	0,4	0,4	0,5	0,9	1,2	1,0
		$\delta_{N,seis}$	[mm]	-	-	0,6	-	-	0,9	-	-	1,3
Non-cracked concrete C20/25 to C50/60	Tension Load	N	[kN]	6,6	8,9	11,8	8,7	14,8	20,5	12,9	20,1	32,8
		δ_{N0}	[mm]	0,1	0,2	0,1	0,1	0,1	0,1	0,1	0,2	0,3
	Displacement	$\delta_{N\infty}$	[mm]	0,3			0,2			0,5		

Table C9: Displacements under shear load HUS3-6, 8, 10 and 14

Anchor size HUS3				6	8			10			14		
				h_{nom}	h_{nom1}	h_{nom2}	h_{nom3}	h_{nom1}	h_{nom2}	h_{nom3}	h_{nom1}	h_{nom2}	h_{nom3}
Nominal embedment depth				55	50	60	70	55	75	85	65	85	115
Cracked concrete C20/25 to C50/60	Shear Load	V	[kN]	6,0	8,1			13,3			21,4		
		δ_{V0}	[mm]	1,9	2,5	3,4	2,9	3,8	3,7	3,2	3,6	3,2	2,4
	Displacement	$\delta_{V\infty}$	[mm]	2,8	3,7	5,1	4,4	5,7	5,5	4,9	5,4	6,9	3,5
		$\delta_{V,seis}$	[mm]	-	-	-	0,6	-	-	0,9	-	-	1,3

Hilti Screw anchor HUS3

Performances
Displacements

Annex C8