

Approval body for construction products
and types of construction

Bautechnisches Prüfamt

An institution established by the Federal and
Laender Governments



European Technical Assessment

ETA-16/0043
of 4 April 2016

English translation prepared by DIBt - Original version in German language

General Part

Technical Assessment Body issuing the
European Technical Assessment:

Deutsches Institut für Bautechnik

Trade name of the construction product

Würth Concrete Screw W-BS/S, W-BS/A4, W-BS/HCR

Product family
to which the construction product belongs

Concrete Screw of sizes 6, 8, 10, 12 and 14 mm for use in
concrete

Manufacturer

Adolf Würth GmbH & Co. KG
Reinhold-Würth-Straße 12-17
74653 Künzelsau
DEUTSCHLAND

Manufacturing plant

Herstellwerk W9

This European Technical Assessment
contains

16 pages including 3 annexes which form an integral part
of this assessment

This European Technical Assessment is
issued in accordance with Regulation (EU)
No 305/2011, on the basis of

Guideline for European technical approval of "Metal
anchor for use in concrete", ETAG 001 Part 3: "Undercut
anchors, April 2013,
used as European Assessment Document (EAD)
according to Article 66 Paragraph 3 of Regulation (EU)
No 305/2011 and European Assessment Document
(EAD) 330011-00-0601.

The European Technical Assessment is issued by the Technical Assessment Body in its official language. Translations of this European Technical Assessment in other languages shall fully correspond to the original issued document and shall be identified as such.

Communication of this European Technical Assessment, including transmission by electronic means, shall be in full. However, partial reproduction may only be made with the written consent of the issuing Technical Assessment Body. Any partial reproduction shall be identified as such.

This European Technical Assessment may be withdrawn by the issuing Technical Assessment Body, in particular pursuant to information by the Commission in accordance with Article 25(3) of Regulation (EU) No 305/2011.

Specific Part

1 Technical description of the product

The Würth Concrete Screw W-BS an anchor in size 6, 8, 10, 12 and 14 made of galvanised steel or stainless steel. The anchor is screwed into a predrilled cylindrical drill hole. The special thread of the anchor cuts an internal thread into the member while setting. The anchorage is characterised by mechanical interlock in the special thread.

Product and product description is given in Annex A.

2 Specification of the intended use in accordance with the applicable European Assessment Document

The performances given in Section 3 are only valid if the anchor is used in compliance with the specifications and conditions given in Annex B.

The verifications and assessment methods on which this European Technical Assessment is based lead to the assumption of a working life of the anchor of at least 50 years. The indications given on the working life cannot be interpreted as a guarantee given by the producer, but are to be regarded only as a means for choosing the right products in relation to the expected economically reasonable working life of the works.

3 Performance of the product and references to the methods used for its assessment

3.1 Mechanical resistance and stability (BWR 1)

Essential characteristic	Performance
Product performance for static and quasi static action	See Annex C 1 and C 2
Product performance for seismic category C1	See Annex C 4
Displacements under tension and shear loads	See Annex C 3

3.2 Safety in case of fire (BWR 2)

Essential characteristic	Performance
Reaction to fire	Anchorage satisfy requirements for Class A1
Resistance to fire	See Annex C 5

3.3 Safety in use (BWR 4)

The essential characteristics regarding Safety in use are included under the Basic Works Requirement Mechanical resistance and stability.

4 Assessment and verification of constancy of performance (AVCP) system applied, with reference to its legal base

In accordance with guideline for European technical approval ETAG 001, April 2013 used as European Assessment Document (EAD) according to Article 66 Paragraph 3 of Regulation (EU) No 305/2011, and European Assessment Document EAD 330011-00-0601 the applicable European legal act is: [96/582/EC].

The system to be applied is: 1

5 Technical details necessary for the implementation of the AVCP system, as provided for in the applicable European Assessment Document

Technical details necessary for the implementation of the AVCP system are laid down in the control plan deposited at Deutsches Institut für Bautechnik.

Issued in Berlin on 4 April 2016 by Deutsches Institut für Bautechnik

Uwe Bender
Head of Department

beglaubigt:
Tempel

Product and installed condition

Concrete Screw W-BS

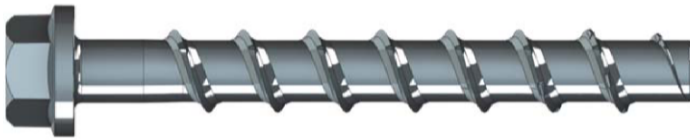

steel, zinc plated



stainless steel A4 and HCR

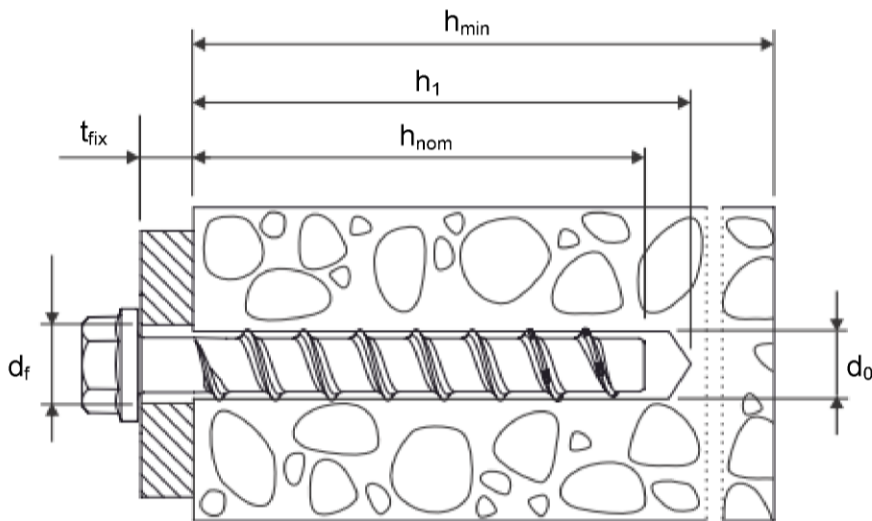

- d_0 = nominal drill bit diameter
- h_{nom} = nominal anchorage depth
- h_1 = depth of the drill hole
- h_{min} = minimum thickness of member
- t_{fix} = thickness of fixture
- d_f = diameter of clearance hole in the fixture

Würth Concrete Screw W-BS/S, W-BS/A4, W-BS/HCR























Product description

Installed condition

Annex A 1

Table A1: materials and variants

part	name	Material			
1, 2, 3, 4, 5, 6, 7, 8, 9, 10, 11	Concrete screw	W-BS/S	Steel EN 10263-4 galvanized acc. to EN ISO 4042 or zinc flake coating acc. to EN ISO 10683 ($\geq 5\mu\text{m}$)		
W-BS/A4		1.4401, 1.4404, 1.4571, 1.4578			
W-BS/HCR		1.4529			
				W-BS/S, W-BS/A4, W-BS/HCR	
		nominal characteristic steel yield strength	f_{yk}	[N/mm ²]	560
		nominal characteristic steel ultimate strength	f_{uk}	[N/mm ²]	700
		elongation at rupture	A_5	[%]	≤ 8

		1)	Anchor version with connection thread and hexagon socket e.g. W-BS 8x105 M10 SW5
		2)	Anchor version with connection thread and hexagon drive e.g. W-BS 8x105 M10 SW7
		3)	Anchor version with washer, hexagon head e.g. W-BS 8x80 SW13
		4)	Anchor version with washer and hexagon head and TORX e.g. W-BS 8x80 SW13 TX40
		5)	Anchor version with washer, hexagon head e.g. W-BS 8x80 SW13
		6)	Anchor version with countersunk head e.g. W-BS 8x80 TX40
		7)	Anchor version with pan head e.g. W-BS 8x80 TX40
		8)	Anchor version with large pan head e.g. W-BS 8x80 TX40
		9)	Anchor version with countersunk head and connection thread e.g. W-BS 6x55 M8
		10)	Anchor version with hexagon drive and connection thread e.g. W-BS 6x55 M8 SW10
		11)	Anchor version with internal thread and hexagon drive e.g. W-BS 6x55 IM M8/10

Würth Concrete Screw W-BS/S, W-BS/A4, W-BS/HCR

Product descriptions
Materials und versions

Annex A 2

Table A2: dimensions and markings

Anchor size W-BS			6		8			10		
Nominal embedment depth h_{nom} [mm]			h_{nom1}	h_{nom2}	h_{nom1}	h_{nom2}	h_{nom3}	h_{nom1}	h_{nom2}	h_{nom3}
			40	55	45	55	65	55	75	85
Length of the anchor	$L \leq$	[mm]	500							
Diameter of shaft	d_k	[mm]	5.1		7.1			9.1		
Diameter of thread	d_s	[mm]	7.5		10.6			12.6		
Anchor size W-BS			12			14				
Nominal embedment depth h_{nom} [mm]			h_{nom1}	h_{nom2}	h_{nom3}	h_{nom1}	h_{nom2}	h_{nom3}		
			65	85	100	75	100	115		
Length of the anchor	$L \leq$	[mm]	500							
Diameter of shaft	d_k	[mm]	11.1			13.1				
Diameter of thread	d_s	[mm]	14.6			16.6				



Marking

W-BS/S
Description:
Anchor size:
Length of the anchor:

W-BS
e.g. 6
e.g. 60



W-BS/A4
Description:
Anchor size:
Length of the anchor:
Material:

TSM or W-BS
e.g. 6
e.g. 60
A4



W-BS/HCR
Description:
Anchor size:
Length of the anchor:
Material:

TSM or W-BS
e.g. 6
e.g. 60
HCR

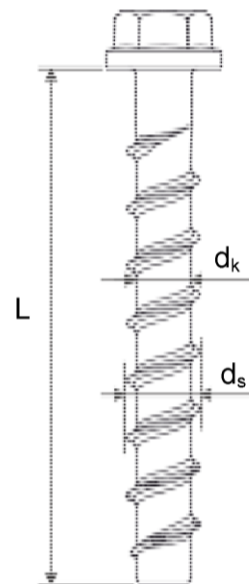

Würth Concrete Screw W-BS/S, W-BS/A4, W-BS/HCR

Product descriptions
Dimensions and markings

Annex A 3

Intended use

Anchorage subject to:

- static and quasi-static loads, all sizes and all embedment depth
- Used for anchorages with requirements related to resistance of fire, all sizes and all embedment depth,
- used for anchorages with seismic actions category C1, sizes 8-14 for maximum embedment depth h_{nom3} .

Base materials:

- reinforced and unreinforced concrete according to EN 206-1:2000-12,
- strength classes C20/25 to C50/60 according to EN 206-1:2000-12,
- cracked and uncracked concrete.

Use conditions (Environmental conditions):

- The anchor may only be used in dry internal conditions: All screw types,
- Structural subject to external atmospheric exposure (including industrial and marine environment) and to permanently damp internal condition no particular aggressive conditions exists: screw types made of stainless steel with marking A4,
- Structural subject to external atmospheric exposure (including industrial and marine environment) and to permanently damp internal condition if particular aggressive conditions exists: screw types made of stainless steel with marking HCR.

Design:

- Anchorages are designed under the responsibility of an engineer experienced in anchorages and concrete work,
- Verifiable calculation notes and drawings are prepared taking account of the loads to be anchored. The position of the anchor is indicated on the design drawings (e.g. position of the anchor relative to reinforcement or to supports, etc.),
- Anchorages under static or quasi-static actions are designed for design Method A in accordance with:
 - ETAG 001, Annex C, Edition August 2010 or
 - CEN/TS 1992-4:2009,
- Anchorages under seismic actions are designed in accordance with:
 - EOTA Technical Report TR 045, Edition February 2013
 - Anchorages shall be positioned outside of critical regions (e.g. plastic hinges) of the concrete structure
 - Fastenings in stand-off installation or with a grout layer are not allowed
- Anchorages under fire exposure are designed in accordance with:
 - EOTA Technical Report TR 020, Edition May 2004 or
 - CEN/TS 1992-4:2009, Annex D (It must be ensured that local spalling of the concrete cover does not occur).
- In general, the conditions given in ETAG 001, Annex C, section 4.2.2.1 a) and section 4.2.2.2 b) are not fulfilled because the diameter of clearance hole in the fixture according to Annex B2, Table B1 is greater than values given in ETAG 001, Annex C, Table 4.1 for the corresponding diameter of the anchor.

Installation:

- Hammer drilling only.
- Anchor installation carried out by appropriately qualified personal and under the supervision of the person responsible for technical matters of the site.
- In case of aborted hole: new drilling at a minimum distance away of twice the depth of aborted hole or smaller distance if the aborted hole is filled with high strength mortar and if under shear or oblique tension load it is not the direction of the load application.
- After installation further turning of the anchor is not possible. The head of the anchor is supported on the fixture and is not damaged.
- The drill hole may be filled with injection mortar WIT-BS.
- Adjustability according to Annex B4: sizes 8-14, all anchorage depths.

Würth Concrete Screw W-BS/S, W-BS/A4, W-BS/HCR

Intended use
Specifications

Annex B 1

Table B1: Installation parameters

Anchor size W-BS			6		8			10		
Nominal embedment depth h_{nom} [mm]			h_{nom1}	h_{nom2}	h_{nom1}	h_{nom2}	h_{nom3}	h_{nom1}	h_{nom2}	h_{nom3}
			40	55	45	55	65	55	75	85
Nominal drill bit diameter	d_0	[mm]	6		8			10		
Cutting diameter of drill bit	$d_{cut} \leq$	[mm]	6.40		8.45			10.45		
Depth of drill hole	$h_1 \geq$	[mm]	45	60	55	65	75	65	85	95
Diameter of clearing hole in the fixture	$d_f \leq$	[mm]	8		12			14		
Installation torque	$T_{inst} \leq$	[Nm]	10		20			40		
Anchor size W-BS			12			14				
Nominal embedment depth h_{nom} [mm]			h_{nom1}	h_{nom2}	h_{nom3}	h_{nom1}	h_{nom2}	h_{nom3}		
			65	85	100	75	100	115		
Nominal drill bit diameter	d_0	[mm]	12			14				
Cutting diameter of drill bit	$d_{cut} \leq$	[mm]	12.50			14.50				
Depth of drill hole	$h_1 \geq$	[mm]	75	95	110	85	110	125		
Diameter of clearing hole in the fixture	$d_f \leq$	[mm]	16			18				
Installation torque	$T_{inst} \leq$	[Nm]	60			80				

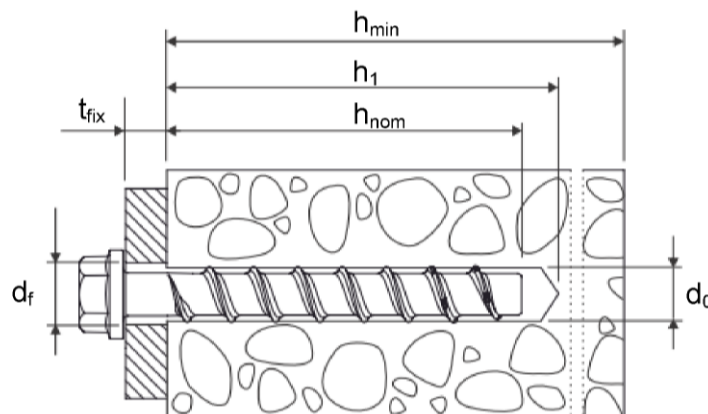

Würth Concrete Screw W-BS/S, W-BS/A4, W-BS/HCR

Intended use

Installation parameters

Annex B 2

Table B2: Minimum thickness of member, minimum edge distance and minimum spacing

Anchor size W-BS			6		8			10		
Nominal embedment depth h_{nom} [mm]			h_{nom1}	h_{nom2}	h_{nom1}	h_{nom2}	h_{nom3}	h_{nom1}	h_{nom2}	h_{nom3}
			40	55	45	55	65	55	75	85
Minimum thickness of member	h_{min}	[mm]	100		100		120	100	130	130
Minimum edge distance	c_{min}	[mm]	40		40	50		50		
Minimum spacing	s_{min}	[mm]	40		40	50		50		
Anchor size W-BS			12			14				
Nominal embedment depth h_{nom} [mm]			h_{nom1}	h_{nom2}	h_{nom3}	h_{nom1}	h_{nom2}	h_{nom3}		
			65	85	100	75	100	115		
Minimum thickness of member	h_{min}	[mm]	120	130	150	130	150	170		
Minimum edge distance	c_{min}	[mm]	50		70	50	70			
Minimum spacing	s_{min}	[mm]	50		70	50	70			

Installation instructions

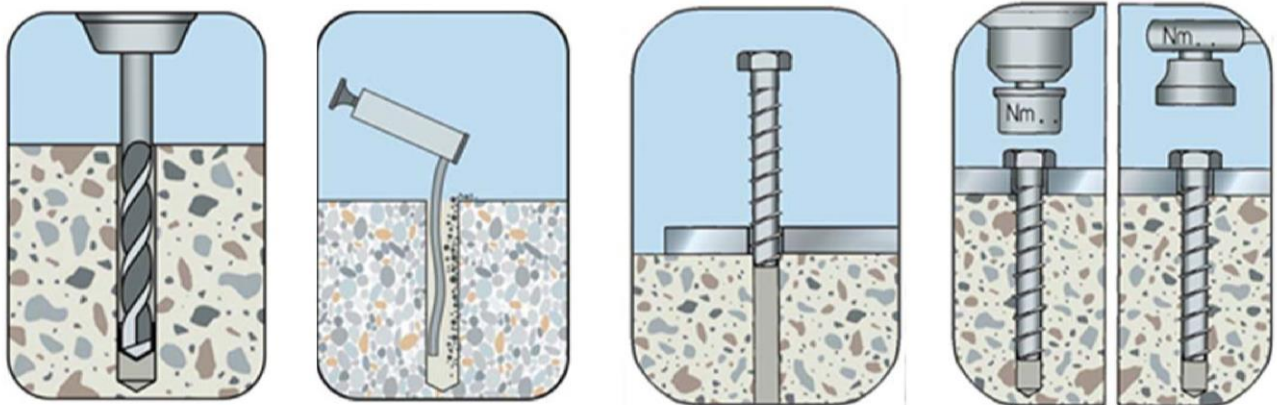

Würth Concrete Screw W-BS/S, W-BS/A4, W-BS/HCR

Intended use

Minimum thickness of member, minimum spacing, minimum edge distance and installation instructions

Annex B 3

Installation instructions for adjustability

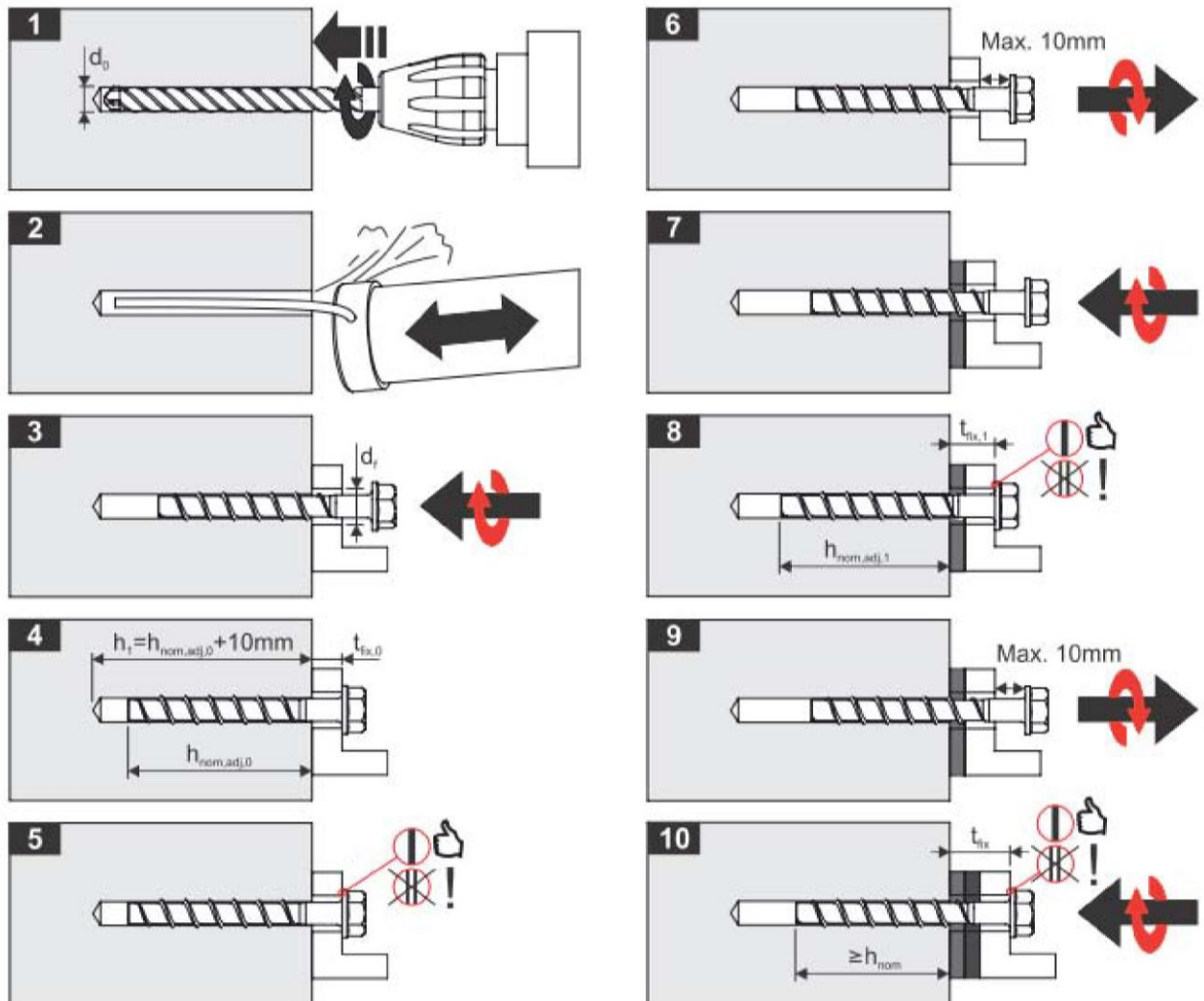

Installation instructions

The anchor may be adjusted maximum two times while the anchor may turn back at most 10 mm.
The total allowed thickness of shims added during the adjustment process is 10mm.
The final embedment depth after adjustment process must be equal or larger than h_{nom} .

Würth Concrete Screw W-BS/S, W-BS/A4, W-BS/HCR

Intended use

Installation instruction for adjustability

Annex B 4

Table C1: Characteristic values for design method A according to ETAG 001, Annex C or CEN/TS 1992-4 for W-BS 6, 8 and 10

Anchor size W-BS			6		8			10			
Nominal embedment depth h_{nom} [mm]			h_{nom1}	h_{nom2}	h_{nom1}	h_{nom2}	h_{nom3}	h_{nom1}	h_{nom2}	h_{nom3}	
			40	55	45	55	65	55	75	85	
steel failure for tension- and shear load											
characteristic load	$N_{Rk,s}$	[kN]	14.0		27.0			45.0			
	$V_{Rk,s}$	[kN]	7.0		17.0			34.0			
	$k_2^{1)}$	[-]	0.8		0.8			0.8			
	$M_{Rk,s}^0$	[Nm]	10.0		26.0			56.0			
partial safety factor	γ_{Ms}	[-]	1.5								
pull-out failure											
characteristic tension load in cracked concrete C20/25	$N_{Rk,p}$	[kN]	2.0	4.0	5.0	9.0	12.0	9.0	Pull-out failure is not decisive		
characteristic tension load in uncracked concrete C20/25	$N_{Rk,p}$	[kN]	4.0	9.0	7.5	12.0	16.0	12.0	20.0	25.0	
increasing factor for $N_{Rk,p}$	ψ_C	C30/37	1.22								
		C40/50	1.41								
		C50/60	1.55								
concrete cone and splitting failure											
effective anchorage depth	h_{ef}	[mm]	31	44	35	43	52	43	60	68	
factor for	cracked	$k_{cr}^{1)}$	7.2								
	uncracked	$k_{ucr}^{1)}$	10.1								
concrete cone failure	spacing	$s_{cr,N}$	$3 \times h_{ef}$								
	edge distance	$c_{cr,N}$	$1.5 \times h_{ef}$								
splitting failure	spacing	$s_{cr,Sp}$	120	160	120	140	150	140	180	210	
	edge distance	$c_{cr,Sp}$	60	80	60	70	75	70	90	105	
installation safety factor	$\gamma_2^{2)}$	[-]	1.0								
	$\gamma_{inst}^{1)}$	[-]									
concrete pry out failure (pry-out)											
k-Factor	$k^{2)}$	[-]	1.0						2.0		
	$k_3^{1)}$										
concrete edge failure											
effective length of anchor	$l_f = h_{ef}$	[mm]	31	44	35	43	52	43	60	68	
outside diameter of anchor	d_{nom}	[mm]	6		8			10			

¹⁾ Parameter relevant only for design according to CEN/TS 1992-4:2009

²⁾ Parameter relevant only for design according to ETAG 001, Annex C

Würth Concrete Screw W-BS/S, W-BS/A4, W-BS/HCR

Performances

Characteristic values for W-BS 6, 8 and 10

Annex C 1

Table C2: Characteristic values for design method A according to ETAG 001, Annex C or CEN/TS 1992-4 for W-BS 12 and 14

Anchor size W-BS			12			14			
Nominal embedment depth h_{nom} [mm]			h_{nom1}	h_{nom2}	h_{nom3}	h_{nom1}	h_{nom2}	h_{nom3}	
			65	85	100	75	100	115	
steel failure for tension- and shear load									
characteristic load	$N_{RK,s}$	[kN]	67.0			94.0			
	$V_{RK,s}$	[kN]	40.0			56.0			
	$k_2^{1)}$	[-]	0.8			0.8			
	$M^0_{RK,s}$	[Nm]	113.0			185.0			
partial safety factor	γ_{Ms}	[-]	1.5						
pull-out failure									
characteristic tension load in cracked concrete C20/25	$N_{RK,p}$	[kN]	12.0	Pull-out failure is not decisive			Pull-out failure is not decisive		
characteristic tension load in uncracked concrete C20/25	$N_{RK,p}$	[kN]	16.0						
increasing factor for $N_{RK,p}$	ψ_C	C30/37	1.22						
		C40/50	1.41						
		C50/60	1.55						
concrete cone and splitting failure									
effective anchorage depth	h_{ef}	[mm]	50	67	80	58	79	92	
factor for	cracked	$k_{cr}^{1)}$	7.2						
	uncracked	$k_{ucr}^{1)}$	10.1						
concrete cone failure	spacing	$s_{cr,N}$	$3 \times h_{ef}$						
	edge distance	$c_{cr,N}$	$1.5 \times h_{ef}$						
splitting failure	spacing	$s_{cr,Sp}$	150	210	240	180	240	280	
	edge distance	$c_{cr,Sp}$	75	105	120	90	120	140	
installation safety factor	$\gamma_2^{2)}$	[-]	1.0						
	$\gamma_{inst}^{1)}$	[-]							
concrete pry out failure (pry-out)									
k-Factor	$k^{2)}$	[-]	1.0	2.0		1.0	2.0		
	$k_3^{1)}$								
concrete edge failure									
effective length of anchor	$l_f = h_{ef}$	[mm]	50	67	80	58	79	92	
outside diameter of anchor	d_{nom}	[mm]	12			14			

¹⁾ Parameter relevant only for design according to CEN/TS 1992-4:2009

²⁾ Parameter relevant only for design according to ETAG 001, Annex C

Würth Concrete Screw W-BS/S, W-BS/A4, W-BS/HCR

Performances

Characteristic values for W-BS 12 and 14

Annex C 2

Table C3: Displacements under tension load for W-BS

Anchor size W-BS				6		8			10		
Nominal embedment depth h_{nom} [mm]				h_{nom1}	h_{nom2}	h_{nom1}	h_{nom2}	h_{nom3}	h_{nom1}	h_{nom2}	h_{nom3}
				40	55	45	55	65	55	75	85
cracked concrete	tension load	N	[kN]	0.95	1.9	2.4	4.3	5.7	4.3	7.9	9.6
	displacement	δ_{N0}	[mm]	0.3	0.6	0.6	0.7	0.8	0.6	0.5	0.9
		$\delta_{N\infty}$	[mm]	0.4	0.4	0.6	1.0	0.9	0.4	1.2	1.2
un- cracked concrete	tension load	N	[kN]	1.9	4.3	3.6	5.7	7.6	5.7	9.5	11.9
	displacement	δ_{N0}	[mm]	0.4	0.6	0.7	0.9	0.5	0.7	1.1	1.0
		$\delta_{N\infty}$	[mm]	0.4	0.4	0.6	1.0	0.9	0.4	1.2	1.2
Anchor size W-BS				12			14				
Nominal embedment depth h_{nom} [mm]				h_{nom1}	h_{nom2}	h_{nom3}	h_{nom1}	h_{nom2}	h_{nom3}		
				65	85	100	75	100	115		
cracked concrete	tension load	N	[kN]	5.7	9.4	12.3	7.6	12.0	15.1		
	displacement	δ_{N0}	[mm]	0.9	0.5	1.0	0.5	0.8	0.7		
		$\delta_{N\infty}$	[mm]	1.0	1.2	1.2	0.9	1.2	1.0		
un- cracked concrete	tension load	N	[kN]	7.6	13.2	17.2	10.6	16.9	21.2		
	displacement	δ_{N0}	[mm]	1.0	1.1	1.2	0.9	1.2	0.8		
		$\delta_{N\infty}$	[mm]	1.0	1.2	1.2	0.9	1.2	1.0		

Table C4 : Displacements under shear load for W-BS

Anchor size W-BS				6		8			10		
Nominal embedment depth h_{nom} [mm]				h_{nom1}	h_{nom2}	h_{nom1}	h_{nom2}	h_{nom3}	h_{nom1}	h_{nom2}	h_{nom3}
				40	55	45	55	65	55	75	85
shear load	V		[kN]	3.3		8.6			16.2		
displacement	δ_{V0}		[mm]	1.55		2.7			2.7		
	$\delta_{V\infty}$		[mm]	3.10		4.1			4.3		
Anchor size W-BS				12			14				
Nominal embedment depth h_{nom} [mm]				h_{nom1}	h_{nom2}	h_{nom3}	h_{nom1}	h_{nom2}	h_{nom3}		
				65	85	100	75	100	115		
shear load	N		[kN]	20.0			30.5				
displacement	δ_{V0}		[mm]	4.0			3.1				
	$\delta_{V\infty}$		[mm]	6.0			4.7				

Würth Concrete Screw W-BS/S, W-BS/A4, W-BS/HCR

Performances

Displacements under tension and shear loads

Annex C 3

Table C5: Characteristic values for seismic category C1

Anchor size W-BS			8	10	12	14
Nominal embedment depth h_{nom} [mm]			h_{nom3}			
			65	85	100	115
steel failure for tension- and shear load						
characteristic load	$N_{Rk,s,seis}$	[kN]	27.0	45.0	67.0	94.0
	$V_{Rk,s,seis}$	[kN]	8.5	15.3	21.0	22.4
partial safety factor	γ_{Ms}	[-]	1.5			
pull-out failure						
characteristic tension load in cracked concrete C20/25	$N_{Rk,p,seis}$	[kN]	12.0	Pull-out failure is not decisive		
concrete cone failure						
effective anchorage depth	h_{ef}	[mm]	52	68	80	92
concrete spacing	$s_{cr,N}$	[mm]	$3 \times h_{ef}$			
concrete edge distance	$c_{cr,N}$	[mm]	$1.5 \times h_{ef}$			
installation safety factor	γ_2	[-]	1.0			
concrete pry out failure (pry-out)						
k-Factor	k	[-]	1.0			
concrete edge failure						
effective length of anchor	$l_f = h_{ef}$	[mm]	52	68	80	92
outside diameter of anchor	d_{nom}	[mm]	8	10	12	14

Würth Concrete Screw W-BS/S, W-BS/A4, W-BS/HCR

Performances

Characteristic values for seismic category C1

Annex C 4

Table C6: Characteristic values of resistance to fire exposure for W-BS

Anchor size W-BS				6		8			10			12			14		
Nominal embedment depth	h_{nom}			1	2	1	2	3	1	2	3	1	2	3	1	2	3
	[mm]			40	55	45	55	65	55	75	85	65	85	100	75	100	115
steel failure for tension- and shear load ($F_{Rk,s,fi} = N_{Rk,s,fi} = V_{Rk,s,fi}$)																	
Fire resistance class																	
R30	Characteristic Resistance	$F_{Rk,s,fi30}$	[kN]	0,9	2,4	4,4	7,3	10,3									
R60		$F_{Rk,s,fi60}$	[kN]	0,8	1,7	3,3	5,8	8,2									
R90		$F_{Rk,s,fi90}$	[kN]	0,6	1,1	2,3	4,2	5,9									
R120		$F_{Rk,s,fi120}$	[kN]	0,4	0,7	1,7	3,4	4,8									
R30		$M^0_{Rk,s,fi30}$	[Nm]	0,7	2,4	5,9	12,3	20,4									
R60		$M^0_{Rk,s,fi60}$	[Nm]	0,6	1,8	4,5	9,7	15,9									
R90		$M^0_{Rk,s,fi90}$	[Nm]	0,5	1,2	3,0	7,0	11,6									
R120		$M^0_{Rk,s,fi120}$	[Nm]	0,3	0,9	2,3	5,7	9,4									
edge distance																	
R30 bis R120	$C_{cr, fi}$		[mm]	2 x h_{ef}													
spacing																	
R30 bis R120	$S_{cr, fi}$		[mm]	4 x h_{ef}													

The characteristic resistance to fire exposure for pull-out failure, concrete cone failure, concrete pry-out failure and concrete edge failure shall be calculated according to TR 020 or CEN/TS 1992-4. If no value for $N_{Rk,p}$ is given, in the equation 2.4 and 2.5, TR 020 or in equation D.1 and D.2, CEN/TS 1992-4 the value of $N^0_{Rk,c}$ shall be inserted instead of $N_{Rk,p}$.

Würth Concrete Screw W-BS/S, W-BS/A4, W-BS/HCR

Performances

Characteristic values of resistance to fire exposure

Annex C 5