

Approval body for construction products
and types of construction

Bautechnisches Prüfamt

An institution established by the Federal and
Laender Governments



European Technical Assessment

ETA-16/0357
of 13 September 2016

English translation prepared by DIBt - Original version in German language

General Part

Technical Assessment Body issuing the
European Technical Assessment:

Deutsches Institut für Bautechnik

Trade name of the construction product

Den Braven Chemical anchor PURE EPOXY for concrete

Product family
to which the construction product belongs

Bonded anchor for use in concrete

Manufacturer

Den Braven Czech and Slovak, A.S.
Úvalno 353
793 91 ÚVALNO
TSCHECHISCHE REPUBLIK

Manufacturing plant

Plant 2 / Výrobní závod c. 2

This European Technical Assessment
contains

27 pages including 3 annexes which form an integral part
of this assessment

This European Technical Assessment is
issued in accordance with Regulation (EU)
No 305/2011, on the basis of

Guideline for European technical approval of "Metal
anchors for use in concrete", ETAG 001 Part 5: "Bonded
anchors", April 2013,
used as European Assessment Document (EAD)
according to Article 66 Paragraph 3 of Regulation (EU)
No 305/2011.

The European Technical Assessment is issued by the Technical Assessment Body in its official language. Translations of this European Technical Assessment in other languages shall fully correspond to the original issued document and shall be identified as such.

Communication of this European Technical Assessment, including transmission by electronic means, shall be in full. However, partial reproduction may only be made with the written consent of the issuing Technical Assessment Body. Any partial reproduction shall be identified as such.

This European Technical Assessment may be withdrawn by the issuing Technical Assessment Body, in particular pursuant to information by the Commission in accordance with Article 25(3) of Regulation (EU) No 305/2011.

Specific Part

1 Technical description of the product

The "Den Braven Chemical anchor PURE POXY for concrete" is a bonded anchor consisting of a cartridge with injection mortar Chemical anchor PURE EPOXY and a steel element. The steel element consist of a commercial threaded rod with washer and hexagon nut in the range of M8 to M30 or a reinforcing bar in the range of diameter 8 to 32 mm.

The steel element is placed into a drilled hole filled with injection mortar and is anchored via the bond between metal part, injection mortar and concrete.

The product description is given in Annex A.

2 Specification of the intended use in accordance with the applicable European Assessment Document

The performances given in Section 3 are only valid if the anchor is used in compliance with the specifications and conditions given in Annex B.

The verifications and assessment methods on which this European Technical Assessment is based lead to the assumption of a working life of the anchor of at least 50 years. The indications given on the working life cannot be interpreted as a guarantee given by the producer, but are to be regarded only as a means for choosing the right products in relation to the expected economically reasonable working life of the works.

3 Performance of the product and references to the methods used for its assessment

3.1 Mechanical resistance and stability (BWR 1)

Essential characteristic	Performance
Characteristic resistance for design according to TR 029 and TR 045	See Annex C 1 to C6
Characteristic resistance for design according to CEN/TS 1992-4:2009 and TR 045	See Annex C 7 to C 12
Displacements under tension and shear loads	See Annex C 13 / C 14

3.2 Safety in case of fire (BWR 2)

Essential characteristic	Performance
Reaction to fire	Anchorage satisfy requirements for Class A1
Resistance to fire	No performance determined (NPD)

3.3 Hygiene, health and the environment (BWR 3)

Regarding dangerous substances there may be requirements (e.g. transposed European legislation and national laws, regulations and administrative provisions) applicable to the products falling within the scope of this European Technical Assessment. In order to meet the provisions of Regulation (EU) No 305/2011, these requirements need also to be complied with, when and where they apply..

3.4 Safety in use (BWR 4)

The essential characteristics regarding Safety in use are included under the Basic Works Requirement Mechanical resistance and stability.

English translation prepared by DIBt

4 Assessment and verification of constancy of performance (AVCP) system applied, with reference to its legal base

In accordance with guideline for European technical approval ETAG 001, April 2013, used as European Assessment Document (EAD) according to Article 66 Paragraph 3 of Regulation (EU) No 305/2011, the applicable European legal act is: [96/582/EC].

The system to be applied is: 1

5 Technical details necessary for the implementation of the AVCP system, as provided for in the applicable European Assessment Document

Technical details necessary for the implementation of the AVCP system are laid down in the control plan deposited at Deutsches Institut für Bautechnik.

Issued in Berlin on 13 September 2016 by Deutsches Institut für Bautechnik

Andreas Kummerow
p.p. Head of Department

beglaubigt:
Baderschneider

Installation threaded rod

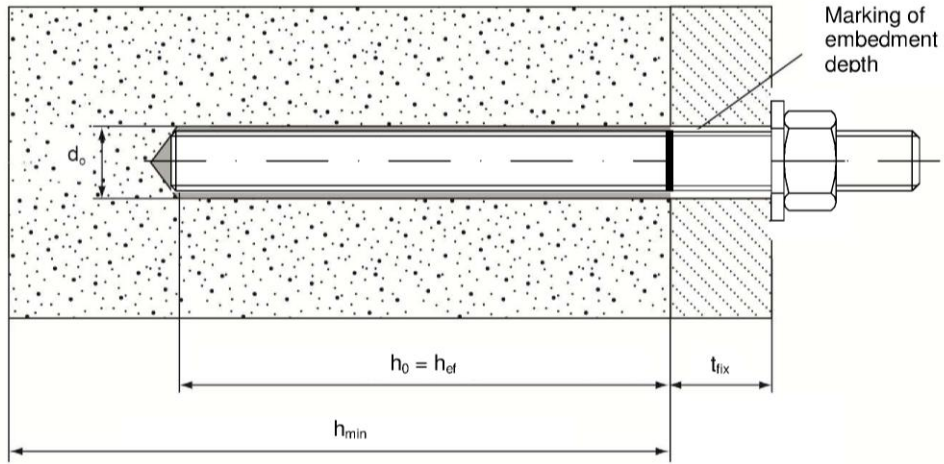

Installation reinforcing bar

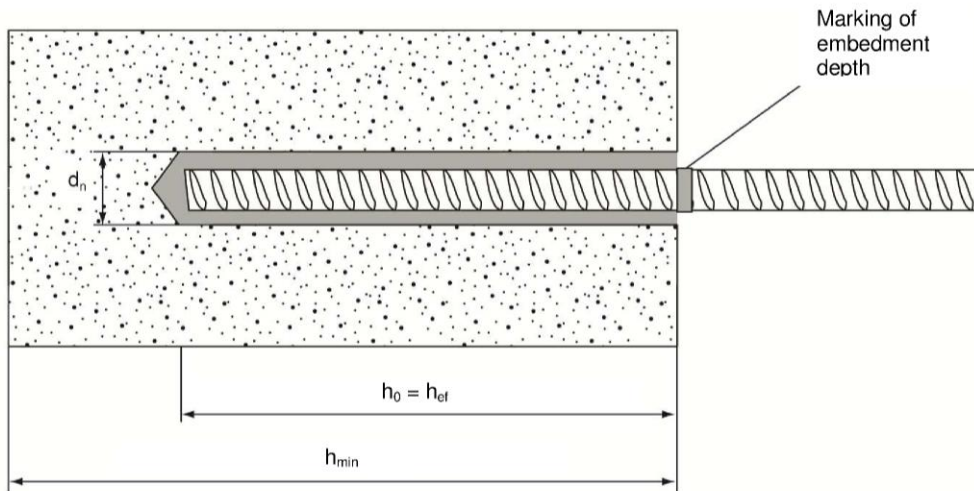

- d_0 = diameter of bore hole
- t_{fix} = thickness of fixture
- h_{ef} = effective anchorage depth
- h_0 = depth of drill hole
- h_{min} = minimum thickness of member

Den Braven Chemical anchor PURE EPOXY for concrete

Product description
Installed condition

Annex A 1

Injection mortar: Chemical anchor PURE EPOXY, Injektionsmörtel PURE EPOXY, Chemická kotva PURE EPOXY

Side-by-Side cartridge
385ml, 585ml, 1000ml and 1400ml

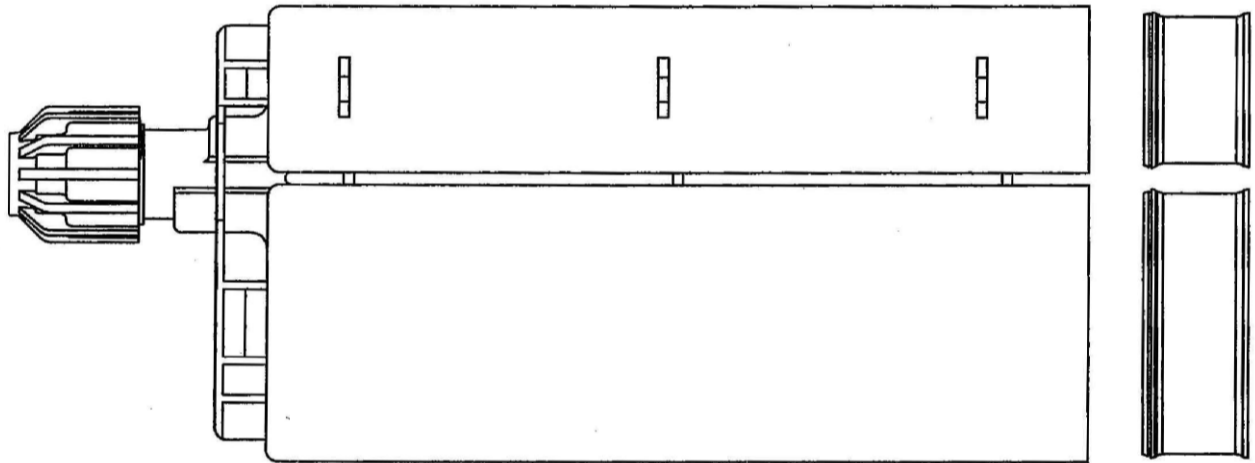

Cartridge label: Chemical anchor PURE EPOXY, Injektionsmörtel PURE EPOXY, Chemická kotva PURE EPOXY, processing notes, charge-code, shelf life, hazard-code, curing- and processing time (depending on the temperature), with as well as without travel scale

Static mixer

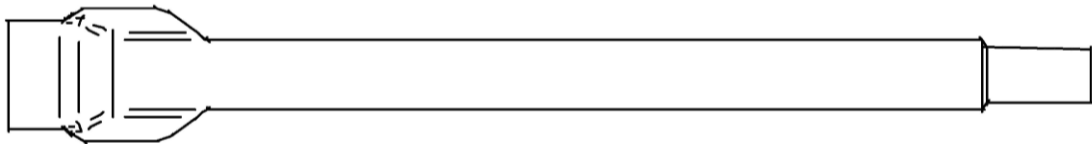

Den Braven Chemical anchor PURE EPOXY for concrete

Product description
Injection system

Annex A 2

Threaded rod M8, M10, M12, M16, M20, M24, M27, M30 with washer and hexagon nut

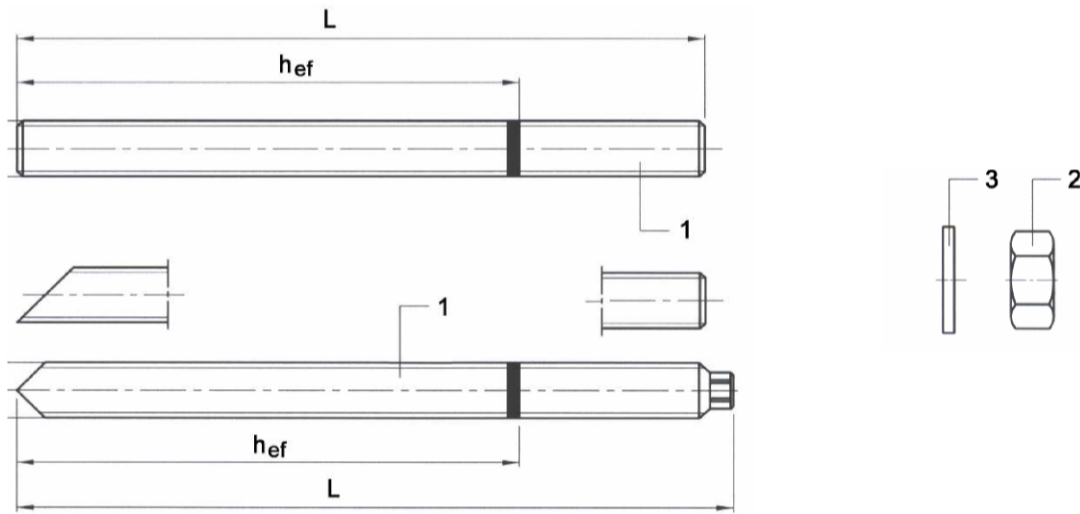

Commercial standard rod with:

- Materials, dimensions and mechanical properties acc. Table A1
- Inspection certificate 3.1 acc. to EN 10204:2004
- Marking of embedment depth

Reinforcing bar $\varnothing 8, \varnothing 10, \varnothing 12, \varnothing 14, \varnothing 16, \varnothing 20, \varnothing 25, \varnothing 28, \varnothing 32$

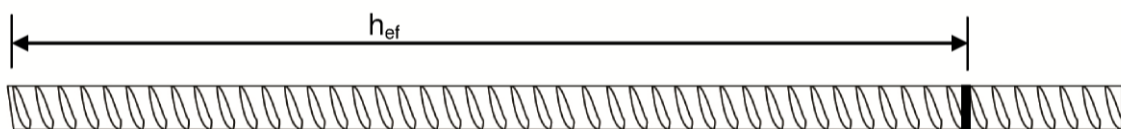

Minimum value of related rip area $f_{R,min}$ according to EN 1992-1-12004+AC:2010
Rib height of the bar shall be in the range $0,05 * d \leq h_{rib} \leq 0,07 * d$
(d = Nominal diameter of the rebar; h: Rib height of the bar)

electronic copy of the eta by dibt: eta-16/0357

Den Braven Chemical anchor PURE EPOXY for concrete

Product description
Threaded rod and reinforcing bar

Annex A 3

Table A1: Materials

Part	Designation	Material
Steel, zinc plated $\geq 5 \mu\text{m}$ acc. to EN ISO 4042 or Steel, hot-dip galvanised $\geq 40 \mu\text{m}$ acc. to EN ISO 1461:2009 and EN ISO 10684:2004+AC:2009		
1	Anchor rod	Steel, EN 10087:1998 or EN 10263:2001 Property class 4.6, 5.8, 8.8, EN 1993-1-8:2005+AC:2009
2	Hexagon nut, EN ISO 4032:2012	Steel acc. to EN 10087:1998 or EN 10263:2001 Property class 4 (for class 4.6 rod) EN ISO 898-2:2012, Property class 5 (for class 5.8 rod) EN ISO 898-2:2012, Property class 8 (for class 8.8 rod) EN ISO 898-2:2012
3	Washer, EN ISO 887:2006, EN ISO 7089:2000, EN ISO 7093:2000 or EN ISO 7094:2000	Steel, zinc plated or hot-dip galvanised
Stainless steel		
1	Anchor rod	Material 1.4401 / 1.4404 / 1.4571, EN 10088-1:2005, > M24: Property class 50 EN ISO 3506-1:2009 \leq M24: Property class 70 EN ISO 3506-1:2009
2	Hexagon nut, EN ISO 4032:2012	Material 1.4401 / 1.4404 / 1.4571 EN 10088:2005, > M24: Property class 50 (for class 50 rod) EN ISO 3506-2:2009 \leq M24: Property class 70 (for class 70 rod) EN ISO 3506-2:2009
3	Washer, EN ISO 887:2006, EN ISO 7089:2000, EN ISO 7093:2000 or EN ISO 7094:2000	Material 1.4401, 1.4404 or 1.4571, EN 10088-1:2005
High corrosion resistance steel		
1	Anchor rod	Material 1.4529 / 1.4565, EN 10088-1:2005, > M24: Property class 50 EN ISO 3506-1:2009 \leq M24: Property class 70 EN ISO 3506-1:2009
2	Hexagon nut, EN ISO 4032:2012	Material 1.4529 / 1.4565 EN 10088-1:2005, > M24: Property class 50 (for class 50 rod) EN ISO 3506-2:2009 \leq M24: Property class 70 (for class 70 rod) EN ISO 3506-2:2009
3	Washer, EN ISO 887:2006, EN ISO 7089:2000, EN ISO 7093:2000 or EN ISO 7094:2000	Material 1.4529 / 1.4565, EN 10088-1:2005
Reinforcing bars		
1	Rebar EN 1992-1-1:2004+AC:2010, Annex C	Bars and de-coiled rods class B or C f_{yk} and k according to NDP or NCL of EN 1992-1-1/NA:2013 $f_{tk} = f_{tk} = k \cdot f_{yk}$

Den Braven Chemical anchor PURE EPOXY for concrete

Product description
Materials

Annex A 4

Specifications of intended use

Anchorage subject to:

- Static and quasi-static loads: M8 to M30, Rebar Ø8 to Ø32.
- Seismic action for Performance Category C1: M12 to M30, Rebar Ø12 to Ø32.
- Seismic action for Performance Category C2: M12 and M16.

Base materials:

- Reinforced or unreinforced normal weight concrete according to EN 206-1:2000.
- Strength classes C20/25 to C50/60 according to EN 206-1:2000.
- Non-cracked concrete: M8 to M30, Rebar Ø8 to Ø32.
- Cracked concrete: M12 to M30, Rebar Ø12 to Ø32.

Temperature Range:

- I: - 40 °C to +40 °C (max long term temperature +24 °C and max short term temperature +40 °C)
- II: - 40 °C to +60 °C (max long term temperature +43 °C and max short term temperature +60 °C)

Use conditions (Environmental conditions):

- Structures subject to dry internal conditions (zinc coated steel, stainless steel or high corrosion resistant steel).
- Structures subject to external atmospheric exposure (including industrial and marine environment) and to permanently damp internal condition, if no particular aggressive conditions exist (stainless steel or high corrosion resistant steel).
- Structures subject to external atmospheric exposure and to permanently damp internal condition, if other particular aggressive conditions exist (high corrosion resistant steel).

Note: Particular aggressive conditions are e.g. permanent, alternating immersion in seawater or the splash zone of seawater, chloride atmosphere of indoor swimming pools or atmosphere with extreme chemical pollution (e.g. in desulphurization plants or road tunnels where de-icing materials are used).

Design:

- Verifiable calculation notes and drawings are prepared taking account of the loads to be anchored. The position of the anchor is indicated on the design drawings (e. g. position of the anchor relative to reinforcement or to supports, etc.).
- Anchorages are designed under the responsibility of an engineer experienced in anchorages and concrete work.
- Anchorages under static or quasi-static actions are designed in accordance with:
 - EOTA Technical Report TR 029 "Design of bonded anchors", Edition September 2010 or
 - CEN/TS 1992-4:2009
- Anchorages under seismic actions (cracked concrete) are designed in accordance with:
 - EOTA Technical Report TR 045 "Design of Metal Anchors under Seismic Action", Edition February 2013
 - Anchorages shall be positioned outside of critical regions (e.g. plastic hinges) of the concrete structure.
 - Fastenings in stand-off installation or with a grout layer are not allowed.

Installation:

- Dry or wet concrete: M8 to M30, Rebar Ø8 to Ø32.
- Flooded holes (not sea water): M8 to M30, Rebar Ø8 to Ø32.
- Hole drilling by hammer or compressed air drill mode.
- Overhead installation allowed.
- Anchor installation carried out by appropriately qualified personnel and under the supervision of the person responsible for technical matters of the site.

Den Braven Chemical anchor PURE EPOXY for concrete

Intended Use
Specifications

Annex B 1

Table B1: Installation parameters for threaded rod

Anchor size		M 8	M 10	M 12	M 16	M 20	M 24	M 27	M 30	
Nominal drill hole diameter	d_0 [mm] =	10	12	14	18	24	28	32	35	
Effective anchorage depth	$h_{ef,min}$ [mm] =	64	80	96	128	160	192	216	240	
	$h_{ef,max}$ [mm] =	96	120	144	192	240	288	324	360	
Diameter of clearance hole in the fixture	d_f [mm] ≤	9	12	14	18	22	26	30	33	
Diameter of steel brush	d_b [mm] ≥	12	14	16	20	26	30	34	37	
Torque moment	T_{inst} [Nm] ≤	10	20	40	80	120	160	180	200	
Thickness of fixture	$t_{fix,min}$ [mm] >	0								
	$t_{fix,max}$ [mm] <	1500								
Minimum thickness of member	h_{min} [mm]	$h_{ef} + 30$ mm ≥ 100 mm			$h_{ef} + 2d_0$					
Minimum spacing	s_{min} [mm]	40	50	60	80	100	120	135	150	
Minimum edge distance	c_{min} [mm]	40	50	60	80	100	120	135	150	

Table B2: Installation parameters for rebar

Rebar size		Ø 8	Ø 10	Ø 12	Ø 14	Ø 16	Ø 20	Ø 25	Ø 28	Ø 32
Nominal drill hole diameter	d_0 [mm] =	12	14	16	18	20	24	32	35	40
Effective anchorage depth	$h_{ef,min}$ [mm] =	64	80	96	112	128	160	200	224	256
	$h_{ef,max}$ [mm] =	96	120	144	168	192	240	300	336	384
Diameter of steel brush	d_b [mm] ≥	14	16	18	20	22	26	34	37	41,5
Minimum thickness of member	h_{min} [mm]	$h_{ef} + 30$ mm ≥ 100 mm			$h_{ef} + 2d_0$					
Minimum spacing	s_{min} [mm]	40	50	60	70	80	100	125	140	160
Minimum edge distance	c_{min} [mm]	40	50	60	70	80	100	125	140	160

Den Braven Chemical anchor PURE EPOXY for concrete

Intended Use
Installation parameters

Annex B 2

Installation instructions

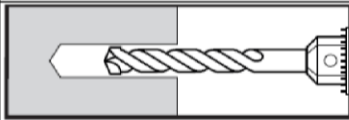

1. Drill with hammer drill a hole into the base material to the size and embedment depth required by the selected anchor (Table B1 or Table B2).

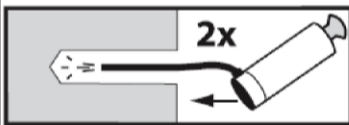

Attention! Standing water in the bore hole must be removed before cleaning.

- 2a. Starting from the bottom or back of the bore hole, blow the hole clean with compressed air (min. 6 bar) or a hand pump (Annex B 5) a minimum of two times. If the bore hole ground is not reached an extension shall be used.

or

The hand-pump can be used for anchor sizes up to bore hole diameter 20 mm.

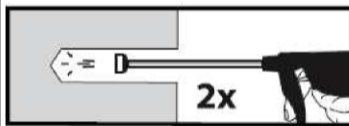

For bore holes larger than 20 mm or deeper 240 mm, compressed air (min. 6 bar) **must** be used.

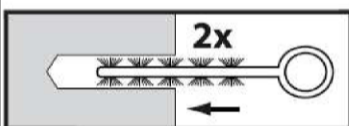

- 2b. Check brush diameter (Table B4) and attach the brush to a drilling machine or a battery screwdriver. Brush the hole with an appropriate sized wire brush $> d_{b,min}$ (Table B4) a minimum of two times. If the bore hole ground is not reached with the brush, a brush extension shall be used (Table B4).

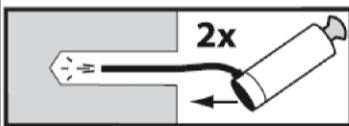

- 2c. Finally blow the hole clean again with compressed air or a hand pump (Annex B 5) a minimum of two times. If the bore hole ground is not reached an extension shall be used.

The hand-pump can be used for anchor sizes up to bore hole diameter 20 mm. For bore holes larger than 20 mm or deeper 240 mm, compressed air (min. 6 bar) **must** be used.

or

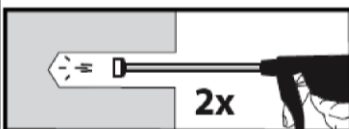

After cleaning, the bore hole has to be protected against re-contamination in an appropriate way, until dispensing the mortar in the bore hole. If necessary, the cleaning repeated has to be directly before dispensing the mortar.

In-flowing water must not contaminate the bore hole again.

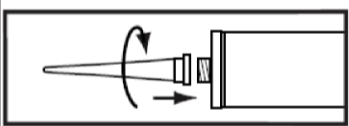

3. Attach a supplied static-mixing nozzle to the cartridge and load the cartridge into the correct dispensing tool. For every working interruption longer than the recommended working time (Table B3) as well as for new cartridges, a new static-mixer shall be used.

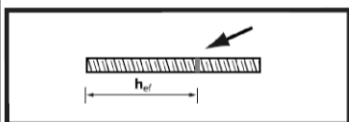

4. Prior to inserting the anchor rod into the filled bore hole, the position of the embedment depth shall be marked on the anchor rods.

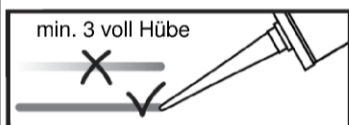

5. Prior to dispensing into the anchor hole, squeeze out separately a minimum of three full strokes and discard non-uniformly mixed adhesive components until the mortar shows a consistent colour.

Den Braven Chemical anchor PURE EPOXY for concrete

Intended Use
Installation instructions

Annex B 3

Installation instructions (continuation)

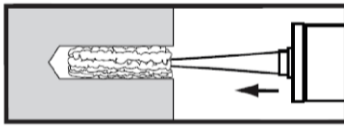

6. Starting from the bottom or back of the cleaned anchor hole fill the hole up to approximately two-thirds with adhesive. Slowly withdraw the static mixing nozzle as the hole fills to avoid creating air pockets. For embedment larger than 190 mm an extension nozzle shall be used. For overhead and horizontal installation in bore holes larger than \varnothing 20 mm a piston plug and extension nozzle (Annex B 5) shall be used. Observe the gel-/ working times given in Table B3.

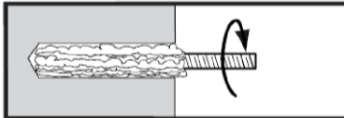

7. Push the threaded rod or reinforcing bar into the anchor hole while turning slightly to ensure positive distribution of the adhesive until the embedment depth is reached. The anchor should be free of dirt, grease, oil or other foreign material.

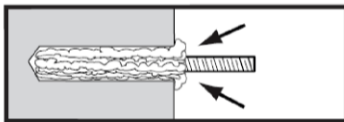

8. Be sure that the anchor is fully seated at the bottom of the hole and that excess mortar is visible at the top of the hole. If these requirements are not maintained, the application has to be renewed. For overhead application the anchor rod should be fixed (e.g. wedges).

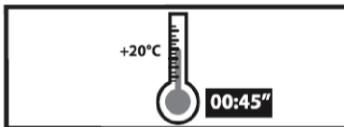

9. Allow the adhesive to cure to the specified time prior to applying any load or torque. Do not move or load the anchor until it is fully cured (attend Table B3).

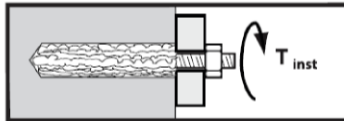

10. After full curing, the add-on part can be installed with the max. torque (Table B1) by using a calibrated torque wrench.

Table B3: Minimum curing time

Base material temperature	Gel time (working time)	Minimum curing time in dry concrete	Minimum curing time in wet concrete
+5°C to +9°C	120 min	50 h	100 h
+10°C to +19°C	90 min	30 h	60 h
+20°C to +29°C	30 min	10 h	20 h
+30°C to +39°C	20 min	6 h	12 h
+40 °C	12 min	4 h	8 h

Den Braven Chemical anchor PURE EPOXY for concrete





Intended Use

Installation instructions (continuation)

Curing time

Annex B 4

Table B4: Parameter cleaning and setting tools

Anchor	Size (mm)	Nominal drill bit diameter d_0 (mm)	Steel Brush d_b (mm)	Steel Brush (min brush diameter) $d_{b,min}$ (mm)	Piston plug
					
Threaded Rod 	M8	10,0	12,0	10,5	Not necessary
	M10	12,0	14,0	12,5	
	M12	14,0	16,0	14,5	
	M16	18,0	20,0	18,5	
	M20	24,0	26,0	24,5	#24
	M24	28,0	30,0	28,5	#28
	M27	32,0	34,0	32,5	#32
	M30	35,0	37,0	35,5	#35
Rebar 	Ø8	12,0	14,0	12,5	Not necessary
	Ø10	14,0	16,0	14,5	
	Ø12	16,0	18,0	16,5	
	Ø14	18,0	20,0	18,5	
	Ø16	20,0	22,0	20,5	
	Ø20	24,0	26,0	24,5	#24
	Ø25	32,0	34,0	32,5	#32
	Ø28	35,0	37,0	35,5	#35
	Ø32	40,0	41,5	38,5	#38

Hand pump (volume 750 ml)

Drill bit diameter (d_0): 10 mm to 20 mm



Compressed air tool (min 6 bar)

Drill bit diameter (d_0): 10 mm to 40 mm



Den Braven Chemical anchor PURE EPOXY for concrete

Intended Use

Cleaning and setting tools

Annex B 5

Table C1: Characteristic values of resistance for threaded rods under tension loads in non-cracked concrete (Design according to TR 029)

Anchor size threaded rod			M 8	M 10	M 12	M 16	M 20	M24	M 27	M 30	
Steel failure											
Characteristic tension resistance, Steel, property class 4.6	$N_{Rk,s}$	[kN]	15	23	34	63	98	141	184	224	
Characteristic tension resistance, Steel, property class 5.8	$N_{Rk,s}$	[kN]	18	29	42	78	122	176	230	280	
Characteristic tension resistance, Steel, property class 8.8	$N_{Rk,s}$	[kN]	29	46	67	125	196	282	368	449	
Characteristic tension resistance, Stainless steel A4 and HCR, property class 50 (>M24) and 70 (\leq M24)	$N_{Rk,s}$	[kN]	26	41	59	110	171	247	230	281	
Combined pull-out and concrete cone failure											
Characteristic bond resistance in non-cracked concrete C20/25											
Temperature range I: 40°C/24°C	dry and wet concrete	$\tau_{Rk,ucr}$	[N/mm ²]	13	13	12	12	11	10	10	10
	flooded bore hole	$\tau_{Rk,ucr}$	[N/mm ²]	13	12	11	9,0	8,0	7,0	6,5	6,0
Temperature range II: 60°C/43°C	dry and wet concrete	$\tau_{Rk,ucr}$	[N/mm ²]	8,0	8,0	7,5	7,0	6,5	6,5	6,0	6,0
	flooded bore hole	$\tau_{Rk,ucr}$	[N/mm ²]	8,0	8,0	7,5	7,0	6,5	6,0	5,5	5,0
Increasing factors for concrete ψ_c		C30/37		1,04							
		C40/50		1,08							
		C50/60		1,10							
Splitting failure											
Edge distance	$h / h_{ef} \geq 2,0$		1,0 h_{ef}								
	$2,0 > h / h_{ef} > 1,3$		4,6 h_{ef} - 1,8 h								
	$h / h_{ef} \leq 1,3$		2,26 h_{ef}								
Axial distance	$s_{cr,sp}$	[mm]	2 $c_{cr,sp}$								
Installation safety factor (dry and wet concrete)	γ_2		1,2				1,4				
Installation safety factor (flooded bore hole)	γ_2		1,4								

Den Braven Chemical anchor PURE EPOXY for concrete

Performances

Characteristic values of resistance for threaded rods under tension loads in non-cracked concrete
Design according to TR 029

Annex C 1

Table C2: Characteristic values of resistance for threaded rods under tension loads in cracked concrete (Design according to TR 029 and TR 045)

Anchor size threaded rod			M 12	M 16	M 20	M24	M 27	M 30	
Steel failure									
Characteristic tension resistance, Steel, property class 4.6	$N_{Rk,s} = N_{Rk,s,seis}$	[kN]	34	63	98	141	184	224	
Characteristic tension resistance, Steel, property class 5.8	$N_{Rk,s} = N_{Rk,s,seis}$	[kN]	42	78	122	176	230	280	
Characteristic tension resistance, Steel, property class 8.8	$N_{Rk,s} = N_{Rk,s,seis}$	[kN]	67	125	196	282	368	449	
Characteristic tension resistance, Stainless steel A4 and HCR, property class 50 (>M24) and 70 (\leq M24)	$N_{Rk,s} = N_{Rk,s,seis}$	[kN]	59	110	171	247	230	281	
Combined pull-out and concrete cone failure									
Characteristic bond resistance in cracked concrete C20/25									
Temperature range I: 40°C/24°C	dry and wet concrete	$\tau_{Rk,cr}$	[N/mm ²]	6,5	5,5	5,0	4,5	4,5	4,5
		$\tau_{Rk,seis,C1}$	[N/mm ²]	6,0	5,2	4,8	4,5	4,5	4,5
		$\tau_{Rk,seis,C2}$	[N/mm ²]	2,1	1,9	No Performance Determined (NPD)			
	flooded bore hole	$\tau_{Rk,cr}$	[N/mm ²]	6,5	5,0	4,0	3,5	3,5	3,5
		$\tau_{Rk,seis,C1}$	[N/mm ²]	6,0	4,8	3,8	3,5	3,5	3,5
		$\tau_{Rk,seis,C2}$	[N/mm ²]	2,1	1,7	No Performance Determined (NPD)			
Temperature range II: 60°C/43°C	dry and wet concrete	$\tau_{Rk,cr}$	[N/mm ²]	4,0	3,0	3,0	2,5	2,5	2,5
		$\tau_{Rk,seis,C1}$	[N/mm ²]	3,7	2,9	2,9	2,5	2,5	2,5
		$\tau_{Rk,seis,C2}$	[N/mm ²]	1,3	1,0	No Performance Determined (NPD)			
	flooded bore hole	$\tau_{Rk,cr}$	[N/mm ²]	4,0	3,0	3,0	2,5	2,5	2,5
		$\tau_{Rk,seis,C1}$	[N/mm ²]	3,7	2,9	2,9	2,5	2,5	2,5
		$\tau_{Rk,seis,C2}$	[N/mm ²]	1,3	1,0	No Performance Determined (NPD)			
Increasing factors for concrete (only static or quasi-static actions) ψ_c	C30/37		1,04						
	C40/50		1,08						
	C50/60		1,10						
Installation safety factor (dry and wet concrete)		γ_2	1,2		1,4				
Installation safety factor (flooded bore hole)		γ_2	1,4						

Den Braven Chemical anchor PURE EPOXY for concrete

Performances

Characteristic values of resistance for threaded rods under tension loads in cracked concrete
Design according to TR 029 and TR 045

Annex C 2

Table C3: Characteristic values of resistance for threaded rods under shear loads in cracked and non-cracked concrete (Design according to TR 029 and TR 045)

Anchor size threaded rod			M 8	M 10	M 12	M 16	M 20	M 24	M 27	M 30
Steel failure without lever arm										
Characteristic shear resistance, Steel, property class 4.6	$V_{Rk,s}$	[kN]	7	12	17	31	49	71	92	112
	$V_{Rk,s,seis,C1}$	[kN]	No Performance Determined (NPD)		14	27	42	56	72	88
	$V_{Rk,s,seis,C2}$	[kN]			13	25	No Performance Determined (NPD)			
Characteristic shear resistance, Steel, property class 5.8	$V_{Rk,s}$	[kN]	9	15	21	39	61	88	115	140
	$V_{Rk,s,seis,C1}$	[kN]	No Performance Determined (NPD)		18	34	53	70	91	111
	$V_{Rk,s,seis,C2}$	[kN]			17	31	No Performance Determined (NPD)			
Characteristic shear resistance, Steel, property class 8.8	$V_{Rk,s}$	[kN]	15	23	34	63	98	141	184	224
	$V_{Rk,s,seis,C1}$	[kN]	No Performance Determined (NPD)		30	55	85	111	145	177
	$V_{Rk,s,seis,C2}$	[kN]			27	50	No Performance Determined (NPD)			
Characteristic shear resistance, Stainless steel A4 and HCR, property class 50 (>M24) and 70 (≤ M24)	$V_{Rk,s}$	[kN]	13	20	30	55	86	124	115	140
	$V_{Rk,s,seis,C1}$	[kN]	No Performance Determined (NPD)		26	48	75	98	91	111
	$V_{Rk,s,seis,C2}$	[kN]			24	44	No Performance Determined (NPD)			
Steel failure with lever arm										
Characteristic bending moment, Steel, property class 4.6	$M^0_{Rk,s}$	[Nm]	15	30	52	133	260	449	666	900
	$M^0_{Rk,s,seis,C1}$	[Nm]	No Performance Determined (NPD)							
	$M^0_{Rk,s,seis,C2}$	[Nm]								
Characteristic bending moment, Steel, property class 5.8	$M^0_{Rk,s}$	[Nm]	19	37	65	166	324	560	833	1123
	$M^0_{Rk,s,seis,C1}$	[Nm]	No Performance Determined (NPD)							
	$M^0_{Rk,s,seis,C2}$	[Nm]								
Characteristic bending moment, Steel, property class 8.8	$M^0_{Rk,s}$	[Nm]	30	60	105	266	519	896	1333	1797
	$M^0_{Rk,s,seis,C1}$	[Nm]	No Performance Determined (NPD)							
	$M^0_{Rk,s,seis,C2}$	[Nm]								
Characteristic bending moment, Stainless steel A4 and HCR, property class 50 (>M24) and 70 (≤ M24)	$M^0_{Rk,s}$	[Nm]	26	52	92	232	454	784	832	1125
	$M^0_{Rk,s,seis,C1}$	[Nm]	No Performance Determined (NPD)							
	$M^0_{Rk,s,seis,C2}$	[Nm]								
Concrete pry-out failure										
Factor k in equation (5.7) of Technical Report TR 029 for the design of Bonded Anchors			2,0							
Installation safety factor			γ_2 1,0							
Concrete edge failure										
See section 5.2.3.4 of Technical Report TR 029 for the design of Bonded Anchors										
Installation safety factor			γ_2 1,0							

Den Braven Chemical anchor PURE EPOXY for concrete

Performances

Characteristic values of resistance for threaded rods under shear loads in cracked and non-cracked concrete, Design according to TR 029 and TR 045

Annex C 3

Table C4: Characteristic values of resistance for rebar under tension loads in non-cracked concrete (Design according to TR 029)

Anchor size reinforcing bar			Ø 8	Ø 10	Ø 12	Ø 14	Ø 16	Ø 20	Ø 25	Ø 28	Ø 32	
Steel failure												
Characteristic tension resistance	$N_{Rk,s}$	[kN]	$A_s \times f_{uk}$									
Combined pull-out and concrete cone failure												
Characteristic bond resistance in non-cracked concrete C20/25												
Temperature range I: 40°C/24°C	dry and wet concrete	$\tau_{Rk,ucr}$	[N/mm ²]	12	12	11	11	10	10	9,5	9,0	9,0
	flooded bore hole	$\tau_{Rk,ucr}$	[N/mm ²]	12	11	9,5	9,0	8,0	7,0	6,0	6,0	5,5
Temperature range II: 60°C/43°C	dry and wet concrete	$\tau_{Rk,ucr}$	[N/mm ²]	7,0	7,0	7,0	6,5	6,5	6,0	5,5	5,5	5,5
	flooded bore hole	$\tau_{Rk,ucr}$	[N/mm ²]	7,0	7,0	7,0	6,5	6,5	6,0	5,0	4,5	4,5
Increasing factors for concrete ψ_c	C30/37		1,04									
	C40/50		1,08									
	C50/60		1,10									
Splitting failure												
Edge distance	$h / h_{ef} \geq 2,0$		1,0 h_{ef}									
	$2,0 > h / h_{ef} > 1,3$		4,6 $h_{ef} - 1,8 h$									
	$h / h_{ef} \leq 1,3$		2,26 h_{ef}									
Axial distance	$s_{cr,sp}$	[mm]	2 $c_{cr,sp}$									
Installation safety factor (dry and wet concrete)	γ_2	1,2						1,4				
Installation safety factor (flooded bore hole)	γ_2	1,4										

Den Braven Chemical anchor PURE EPOXY for concrete

Performances

Characteristic values of resistance for rebar under tension loads in non-cracked concrete
Design according to TR 029

Annex C 4

Table C5: Characteristic values of resistance for rebar under tension loads in cracked concrete (Design according to TR 029 and TR 045)

Anchor size reinforcing bar				Ø 12	Ø 14	Ø 16	Ø 20	Ø 25	Ø 28	Ø 32
Steel failure										
Characteristic tension resistance	$N_{Rk,s} = N_{Rk,s,seis,C1}$	[kN]	$A_s \times f_{uk}$							
Combined pull-out and concrete cone failure										
Characteristic bond resistance in cracked concrete C20/25										
Temperature range I: 40°C/24°C	dry and wet concrete	$\tau_{Rk,cr}$	[N/mm ²]	6,5	5,5	5,5	5,0	4,5	4,5	4,5
		$\tau_{Rk,seis,C1}$	[N/mm ²]	6,0	5,0	5,2	4,8	4,5	4,5	4,5
	flooded bore hole	$\tau_{Rk,cr}$	[N/mm ²]	6,5	5,5	5,0	4,0	3,5	3,5	3,5
		$\tau_{Rk,seis,C1}$	[N/mm ²]	6,0	5,0	4,8	3,8	3,5	3,5	3,5
Temperature range II: 60°C/43°C	dry and wet concrete	$\tau_{Rk,cr}$	[N/mm ²]	4,0	3,5	3,0	3,0	2,5	2,5	2,5
		$\tau_{Rk,seis,C1}$	[N/mm ²]	3,7	3,2	2,9	2,9	2,5	2,5	2,5
	flooded bore hole	$\tau_{Rk,cr}$	[N/mm ²]	4,0	3,5	3,0	3,0	2,5	2,5	2,5
		$\tau_{Rk,seis,C1}$	[N/mm ²]	3,7	3,2	2,9	2,9	2,5	2,5	2,5
Increasing factors for concrete (only static or quasi-static actions) ψ_c		C30/37		1,04						
		C40/50		1,08						
		C50/60		1,10						
Installation safety factor (dry and wet concrete)		γ_2	1,2				1,4			
Installation factor (flooded bore hole)		γ_2	1,4							

Den Braven Chemical anchor PURE EPOXY for concrete

Performances

Characteristic values of resistance for rebar under tension loads in cracked concrete
Design according to TR 029 and TR 045

Annex C 5

Table C6: Characteristic values of resistance for rebar under shear loads in cracked and non-cracked concrete (Design according to TR 029 and TR 045)

Anchor size reinforcing bar		Ø 8	Ø 10	Ø 12	Ø 14	Ø 16	Ø 20	Ø 25	Ø 28	Ø 32
Steel failure without lever arm										
Characteristic shear resistance	$V_{Rk,s}$	[kN]	$0,50 \times A_s \times f_{uk}$							
	$V_{Rk,s,seis,C1}$	[kN]	No Performance Determined (NPD)	$0,44 \times A_s \times f_{uk}$						
Steel failure with lever arm										
Characteristic bending moment	$M^0_{Rk,s}$	[Nm]	$1.2 \cdot W_{el} \cdot f_{uk}$							
	$M^0_{Rk,s,seis,C1}$	[Nm]	No Performance Determined (NPD)							
Concrete pry-out failure										
Factor k in equation (5.7) of Technical Report TR 029 for the design of bonded anchors		2,0								
Installation safety factor	γ_2	1,0								
Concrete edge failure										
See section 5.2.3.4 of Technical Report TR 029 for the design of Bonded Anchors										
Installation safety factor	γ_2	1,0								

Den Braven Chemical anchor PURE EPOXY for concrete

Performances

Characteristic values of resistance for rebar under shear loads in cracked and non-cracked concrete, Design according to TR 029 and TR 045

Annex C 6

Table C7: Characteristic values of resistance for threaded rods under tension loads in non-cracked concrete (Design according to CEN/TS 1992-4)

Anchor size threaded rod			M 8	M 10	M 12	M 16	M 20	M24	M 27	M 30	
Steel failure											
Characteristic tension resistance, Steel, property class 4.6	$N_{Rk,s}$	[kN]	15	23	34	63	98	141	184	224	
Characteristic tension resistance, Steel, property class 5.8	$N_{Rk,s}$	[kN]	18	29	42	78	122	176	230	280	
Characteristic tension resistance, Steel, property class 8.8	$N_{Rk,s}$	[kN]	29	46	67	125	196	282	368	449	
Characteristic tension resistance, Stainless steel A4 and HCR, property class 50 (>M24) and 70 (\leq M24)	$N_{Rk,s}$	[kN]	26	41	59	110	171	247	230	281	
Combined pull-out and concrete failure											
Characteristic bond resistance in non-cracked concrete C20/25											
Temperature range I: 40°C/24°C	dry and wet concrete	$\tau_{Rk,ucr}$	[N/mm ²]	13	13	12	12	11	10	10	10
	flooded bore hole	$\tau_{Rk,ucr}$	[N/mm ²]	13	12	11	9,0	8,0	7,0	6,5	6,0
Temperature range II: 60°C/43°C	dry and wet concrete	$\tau_{Rk,ucr}$	[N/mm ²]	8,0	8,0	7,5	7,0	6,5	6,5	6,0	6,0
	flooded bore hole	$\tau_{Rk,ucr}$	[N/mm ²]	8,0	8,0	7,5	7,0	6,5	6,0	5,5	5,0
Increasing factors for concrete ψ_c	C30/37			1,04							
	C40/50			1,08							
	C50/60			1,10							
Factor according to CEN/TS 1992-4-5 Section 6.2.2.3	k_B	[-]	10,1								
Concrete cone failure											
Factor according to CEN/TS 1992-4-5 Section 6.2.3.1	k_{ucr}	[-]	10,1								
Edge distance	$c_{cr,N}$	[mm]	1,5 h_{ef}								
Axial distance	$s_{cr,N}$	[mm]	3,0 h_{ef}								
Splitting failure											
Edge distance	$h / h_{ef} \geq 2,0$			1,0 h_{ef}							
	$2,0 > h / h_{ef} > 1,3$			4,6 h_{ef} - 1,8 h							
	$h / h_{ef} \leq 1,3$			2,26 h_{ef}							
Axial distance	$s_{cr,sp}$	[mm]	2 $c_{cr,sp}$								
Installation safety factor (dry and wet concrete)	γ_{inst}		1,2				1,4				
Installation safety factor (flooded bore hole)	γ_{inst}		1,4								

Den Braven Chemical anchor PURE EPOXY for concrete

Performances

Characteristic values of resistance for threaded rods under tension loads in non-cracked concrete
Design according to CEN/TS 1992-4

Annex C 7

Table C8: Characteristic values of resistance for threaded rods under tension loads in cracked concrete (Design according to CEN/TS 1992-4 and TR 045)

Anchor size threaded rod			M 12	M 16	M 20	M24	M27	M30	
Steel failure									
Characteristic tension resistance, Steel, property class 4.6	$N_{Rk,s} = N_{Rk,seis}$	[kN]	34	63	98	141	184	224	
Characteristic tension resistance, Steel, property class 5.8	$N_{Rk,s} = N_{Rk,seis}$	[kN]	42	78	122	176	230	280	
Characteristic tension resistance, Steel, property class 8.8	$N_{Rk,s} = N_{Rk,seis}$	[kN]	67	125	196	282	368	449	
Characteristic tension resistance, Stainless steel A4 and HCR, property class 50 (>M24) and 70 (\leq M24)	$N_{Rk,s} = N_{Rk,seis}$	[kN]	59	110	171	247	230	281	
Combined pull-out and concrete failure									
Characteristic bond resistance in cracked concrete C20/25									
Temperature range I: 40°C/24°C	dry and wet concrete	$\tau_{Rk,cr}$	[N/mm ²]	6,5	5,5	5,0	4,5	4,5	4,5
		$\tau_{Rk,seis,C1}$	[N/mm ²]	6,0	5,2	4,8	4,5	4,5	4,5
		$\tau_{Rk,seis,C2}$	[N/mm ²]	2,1	1,9	No Performance Determined (NPD)			
	flooded bore hole	$\tau_{Rk,cr}$	[N/mm ²]	6,5	5,0	4,0	3,5	3,5	3,5
		$\tau_{Rk,seis,C1}$	[N/mm ²]	6,0	4,8	3,8	3,5	3,5	3,5
		$\tau_{Rk,seis,C2}$	[N/mm ²]	2,1	1,7	No Performance Determined (NPD)			
Temperature range II: 60°C/43°C	dry and wet concrete	$\tau_{Rk,cr}$	[N/mm ²]	4,0	3,0	3,0	2,5	2,5	2,5
		$\tau_{Rk,seis,C1}$	[N/mm ²]	3,7	2,9	2,9	2,5	2,5	2,5
		$\tau_{Rk,seis,C2}$	[N/mm ²]	1,3	1,0	No Performance Determined (NPD)			
	flooded bore hole	$\tau_{Rk,cr}$	[N/mm ²]	4,0	3,0	3,0	2,5	2,5	2,5
		$\tau_{Rk,seis,C1}$	[N/mm ²]	3,7	2,9	2,9	2,5	2,5	2,5
		$\tau_{Rk,seis,C2}$	[N/mm ²]	1,3	1,0	No Performance Determined (NPD)			
Increasing factors for concrete (only static or quasi-static actions) ψ_c	C30/37		1,04						
	C40/50		1,08						
	C50/60		1,10						
Factor according to CEN/TS 1992-4-5 Section 6.2.2.3	k_B	[-]	7,2						
Concrete cone failure									
Factor according to CEN/TS 1992-4-5 Section 6.2.3.1	k_{cr}	[-]	7,2						
Edge distance	$c_{cr,N}$	[mm]	1,5 h_{ef}						
Axial distance	$s_{cr,N}$	[mm]	3,0 h_{ef}						
Installation safety factor (dry and wet concrete)	γ_{inst}		1,2			1,4			
Installation safety factor (flooded bore hole)	γ_{inst}		1,4						

Den Braven Chemical anchor PURE EPOXY for concrete

Performances

Characteristic values of resistance for threaded rods under tension loads in cracked concrete
Design according to CEN/TS 1992-4 and TR 045

Annex C 8

Table C9: Characteristic values of resistance for threaded rods under shear loads in cracked and non-cracked concrete (Design according to CEN/TS 1992-4 and TR 045)

Anchor size threaded rod			M 8	M 10	M 12	M 16	M 20	M24	M 27	M 30
Steel failure without lever arm										
Characteristic shear resistance, Steel, property class 4.6	$V_{Rk,s}$	[kN]	7	12	17	31	49	71	92	112
	$V_{Rk,s,seis,C1}$	[kN]	No Performance Determined (NPD)		14	27	42	56	72	88
	$V_{Rk,s,seis,C2}$	[kN]	No Performance Determined (NPD)		13	25	No Performance Determined (NPD)			
Characteristic shear resistance, Steel, property class 5.8	$V_{Rk,s}$	[kN]	9	15	21	39	61	88	115	140
	$V_{Rk,s,seis,C1}$	[kN]	No Performance Determined (NPD)		18	34	53	70	91	111
	$V_{Rk,s,seis,C2}$	[kN]	No Performance Determined (NPD)		17	31	No Performance Determined (NPD)			
Characteristic shear resistance, Steel, property class 8.8	$V_{Rk,s}$	[kN]	15	23	34	63	98	141	184	224
	$V_{Rk,s,seis,C1}$	[kN]	No Performance Determined (NPD)		30	55	85	111	145	177
	$V_{Rk,s,seis,C2}$	[kN]	No Performance Determined (NPD)		27	50	No Performance Determined (NPD)			
Characteristic shear resistance, Stainless steel A4 and HCR, property class 50 (>M24) and 70 (≤ M24)	$V_{Rk,s}$	[kN]	13	20	30	55	86	124	115	140
	$V_{Rk,s,seis,C1}$	[kN]	No Performance Determined (NPD)		26	48	75	98	91	111
	$V_{Rk,s,seis,C2}$	[kN]	No Performance Determined (NPD)		40	44	No Performance Determined (NPD)			
Ductility factor according to CEN/TS 1992-4-5 Section 6.3.2.1	k_2		0,8							
Steel failure with lever arm										
Characteristic bending moment, Steel, property class 4.6	$M_{Rk,s}^0$	[Nm]	15	30	52	133	260	449	666	900
	$M_{Rk,s,seis,C1}^0$	[Nm]	No Performance Determined (NPD)							
	$M_{Rk,s,seis,C2}^0$	[Nm]	No Performance Determined (NPD)							
Characteristic bending moment, Steel, property class 5.8	$M_{Rk,s}^0$	[Nm]	19	37	65	166	324	560	833	1123
	$M_{Rk,s,seis,C1}^0$	[Nm]	No Performance Determined (NPD)							
	$M_{Rk,s,seis,C2}^0$	[Nm]	No Performance Determined (NPD)							
Characteristic bending moment, Steel, property class 8.8	$M_{Rk,s}^0$	[Nm]	30	60	105	266	519	896	1333	1797
	$M_{Rk,s,seis,C1}^0$	[Nm]	No Performance Determined (NPD)							
	$M_{Rk,s,seis,C2}^0$	[Nm]	No Performance Determined (NPD)							
Characteristic bending moment, Stainless steel A4 and HCR, property class 50 (>M24) and 70 (≤ M24)	$M_{Rk,s}^0$	[Nm]	26	52	92	232	454	784	832	1125
	$M_{Rk,s,seis,C1}^0$	[Nm]	No Performance Determined (NPD)							
	$M_{Rk,s,seis,C2}^0$	[Nm]	No Performance Determined (NPD)							
Concrete pry-out failure										
Factor in equation (27) of CEN/TS 1992-4-5 Section 6.3.3	k_3		2,0							
Installation safety factor	γ_{inst}		1,0							
Concrete edge failure										
Effective length of anchor	l_f	[mm]	$l_f = \min(h_{ef}; 8 d_{nom})$							
Outside diameter of anchor	d_{nom}	[mm]	8	10	12	16	20	24	27	30
Installation safety factor	γ_{inst}		1,0							

Den Braven Chemical anchor PURE EPOXY for concrete

Performances

Characteristic values of resistance for threaded rods under shear loads in cracked and non-cracked concrete, Design according to CEN/TS 1992-4 and TR 045

Annex C 9

Table C10: Characteristic values of resistance for rebar under tension loads in non cracked concrete (Design according to CEN/TS 1992-4)

Anchor size reinforcing bar			Ø 8	Ø 10	Ø 12	Ø 14	Ø 16	Ø 20	Ø 25	Ø 28	Ø 32	
Steel failure												
Characteristic tension resistance		$N_{Rk,s}$	[kN]		$A_s \times f_{uk}$							
Combined pull-out and concrete failure												
Characteristic bond resistance in non-cracked concrete C20/25												
Temperature range I: 40°C/24°C	dry and wet concrete	$\tau_{Rk,ucr}$	[N/mm ²]	12	12	11	11	10	10	9,5	9,0	9,0
	flooded bore hole	$\tau_{Rk,ucr}$	[N/mm ²]	12	11	9,5	9,0	8,0	7,0	6,0	6,0	5,5
Temperature range II: 60°C/43°C	dry and wet concrete	$\tau_{Rk,ucr}$	[N/mm ²]	7,0	7,0	7,0	6,5	6,5	6,0	5,5	5,5	5,5
	flooded bore hole	$\tau_{Rk,ucr}$	[N/mm ²]	7,0	7,0	7,0	6,5	6,5	6,0	5,0	4,5	4,5
Increasing factors for concrete ψ_c		C30/37		1,04								
		C40/50		1,08								
		C50/60		1,10								
Factor according to CEN/TS 1992-4-5 Section 6.2.2.3		k_8	[-]	10,1								
Concrete cone failure												
Factor according to CEN/TS 1992-4-5 Section 6.2.3.1		k_{ucr}	[-]	10,1								
Edge distance		$c_{cr,N}$	[mm]	$1,5 h_{ef}$								
Axial distance		$s_{cr,N}$	[mm]	$3,0 h_{ef}$								
Splitting failure												
Edge distance		$h / h_{ef} \geq 2,0$		$1,0 h_{ef}$								
		$2,0 > h / h_{ef} > 1,3$		$4,6 h_{ef} - 1,8 h$								
		$h / h_{ef} \leq 1,3$		$2,26 h_{ef}$								
Axial distance		$s_{cr,sp}$	[mm]	$2 c_{cr,sp}$								
Installation safety factor (dry and wet concrete)		γ_{inst}		1,2					1,4			
Installation safety factor (flooded bore hole)		γ_{inst}		1,4								

Den Braven Chemical anchor PURE EPOXY for concrete

Performances

Characteristic values of resistance for rebar under tension loads in non-cracked concrete
Design according to CEN/TS 1992-4

Annex C 10

Table C11: Characteristic values of resistance for rebar under tension loads in cracked concrete (Design according to CEN/TS 1992-4 and TR 045)

Anchor size reinforcing bar			Ø 12	Ø 14	Ø 16	Ø 20	Ø 25	Ø 28	Ø 32	
Steel failure										
Characteristic tension resistance	$N_{Rk,s} =$ $N_{Rk,s,seis,C1}$	[kN]	$A_s \times f_{uk}$							
Combined pull-out and concrete failure										
Characteristic bond resistance in cracked concrete C20/25										
Temperature range I: 40°C/24°C	dry and wet concrete	$\tau_{Rk,cr}$	[N/mm ²]	6,5	5,5	5,5	5,0	4,5	4,5	4,5
		$\tau_{Rk,seis,C1}$	[N/mm ²]	6,0	5,0	5,2	4,8	4,5	4,5	4,5
	flooded bore hole	$\tau_{Rk,cr}$	[N/mm ²]	6,5	5,5	5,0	4,0	3,5	3,5	3,5
		$\tau_{Rk,seis,C1}$	[N/mm ²]	6,0	5,0	4,8	3,8	3,5	3,5	3,5
Temperature range II: 60°C/43°C	dry and wet concrete	$\tau_{Rk,cr}$	[N/mm ²]	4,0	3,5	3,0	3,0	2,5	2,5	2,5
		$\tau_{Rk,seis,C1}$	[N/mm ²]	3,7	3,2	2,9	2,9	2,5	2,5	2,5
	flooded bore hole	$\tau_{Rk,cr}$	[N/mm ²]	4,0	3,5	3,0	3,0	2,5	2,5	2,5
		$\tau_{Rk,seis,C1}$	[N/mm ²]	3,7	3,2	2,9	2,9	2,5	2,5	2,5
Increasing factors for concrete (only static or quasi-static actions) ψ_c		C30/37		1,04						
		C40/50		1,08						
		C50/60		1,10						
Factor according to CEN/TS 1992-4-5 Section 6.2.2.3		k_8	[-]	7,2						
Concrete cone failure										
Factor according to CEN/TS 1992-4-5 Section 6.2.3.1		k_{cr}	[-]	7,2						
Edge distance		$c_{cr,N}$	[mm]	1,5 h_{ef}						
Axial distance		$s_{cr,N}$	[mm]	3,0 h_{ef}						
Installation safety factor (dry and wet concrete)		γ_{inst}		1,2			1,4			
Installation safety factor (flooded bore hole)		γ_{inst}		1,4						

Den Braven Chemical anchor PURE EPOXY for concrete

Performances

Characteristic values of resistance for rebar under tension loads in cracked concrete
Design according to CEN/TS 1992-4 and TR 045

Annex C 11

Table C12: Characteristic values of resistance for rebar under shear loads in cracked and non-cracked concrete (Design according to CEN/TS 1992-4 and TR 045)

Anchor size reinforcing bar		Ø 8	Ø 10	Ø 12	Ø 14	Ø 16	Ø 20	Ø 25	Ø 28	Ø 32	
Steel failure without lever arm											
Characteristic shear resistance	$V_{RK,s}$	[kN]	$0,50 \times A_s \times f_{uk}$								
	$V_{RK,s,seis,C1}$	[kN]	No Performance Determined (NPD)	$0,44 \times A_s \times f_{uk}$							
Ductility factor according to CEN/TS 1992-4-5 Section 6.3.2.1	k_2		0,8								
Steel failure with lever arm											
Characteristic bending moment	$M^0_{RK,s}$	[Nm]	$1,2 \cdot W_{el} \cdot f_{uk}$								
	$M^0_{RK,s,seis,C1}$	[Nm]	No Performance Determined (NPD)								
Concrete pry-out failure											
Factor in equation (27) of CEN/TS 1992-4-5 Section 6.3.3	k_3		2,0								
Installation safety factor	γ_{inst}		1,0								
Concrete edge failure											
Effective length of anchor	l_l	[mm]	$l_l = \min(h_{ef}; 8 d_{nom})$								
Outside diameter of anchor	d_{nom}	[mm]	8	10	12	14	16	20	24	27	30
Installation safety factor	γ_{inst}		1,0								

Den Braven Chemical anchor PURE EPOXY for concrete

Performances

Characteristic values of resistance for rebar under shear loads in cracked and non-cracked concrete, Design according to CEN/TS 1992-4 and TR 045

Annex C 12

Table C13: Displacements under tension load¹⁾ (threaded rod)

Anchor size threaded rod			M 8	M 10	M 12	M 16	M 20	M 24	M 27	M 30
Non-cracked concrete C20/25 under static and quasi-static action										
40°C/24°C ²⁾	δ_{N0} – factor	[mm/(N/mm ²)]	0,011	0,013	0,015	0,020	0,024	0,029	0,032	0,035
	$\delta_{N\infty}$ – factor	[mm/(N/mm ²)]	0,044	0,052	0,061	0,079	0,096	0,114	0,127	0,140
60°C/43°C ²⁾	δ_{N0} – factor	[mm/(N/mm ²)]	0,013	0,015	0,018	0,023	0,028	0,033	0,037	0,043
	$\delta_{N\infty}$ – factor	[mm/(N/mm ²)]	0,050	0,060	0,070	0,091	0,111	0,131	0,146	0,161
Cracked concrete C20/25 under static, quasi-static and seismic C1 action										
40°C/24°C ²⁾	δ_{N0} – factor	[mm/(N/mm ²)]	No Performance Determined (NPD)		0,032	0,037	0,042	0,048	0,053	0,058
	$\delta_{N\infty}$ – factor	[mm/(N/mm ²)]			0,21	0,21	0,21	0,21	0,21	0,21
60°C/43°C ²⁾	δ_{N0} – factor	[mm/(N/mm ²)]			0,037	0,043	0,049	0,055	0,061	0,067
	$\delta_{N\infty}$ – factor	[mm/(N/mm ²)]			0,24	0,24	0,24	0,24	0,24	0,24
Cracked concrete C20/25 under seismic C2 action										
40°C/24°C ²⁾	$\delta_{N,seis(DLS)}$	[mm/(N/mm ²)]	No Performance Determined (NPD)		0,03	0,05	No Performance Determined (NPD)			
	$\delta_{N,seis(ULS)}$	[mm/(N/mm ²)]			0,06	0,09				
60°C/43°C ²⁾	$\delta_{N,seis(DLS)}$	[mm/(N/mm ²)]			0,03	0,05				
	$\delta_{N,seis(ULS)}$	[mm/(N/mm ²)]			0,06	0,09				

¹⁾ Calculation of the displacement

$$\delta_{N0} = \delta_{N0} - \text{factor} \cdot \tau;$$

$$\delta_{N\infty} = \delta_{N\infty} - \text{factor} \cdot \tau;$$

Table C14: Displacements under shear load¹⁾ (threaded rod)

Anchor size threaded rod			M 8	M 10	M 12	M 16	M 20	M 24	M 27	M 30
Non-cracked and cracked concrete C20/25 under static, quasi-static and seismic C1 action										
All temperatures	δ_{V0} – factor	[mm/(kN)]	0,06	0,06	0,05	0,04	0,04	0,03	0,03	0,03
	$\delta_{V\infty}$ – factor	[mm/(kN)]	0,09	0,08	0,08	0,06	0,06	0,05	0,05	0,05
Cracked concrete C20/25 under seismic C2 action										
All temperatures	$\delta_{V,seis(DLS)}$	[mm/kN]	No Performance Determined (NPD)		0,2	0,1	No Performance Determined (NPD)			
	$\delta_{V,seis(ULS)}$	[mm/kN]			0,2	0,1				

¹⁾ Calculation of the displacement

$$\delta_{V0} = \delta_{V0} - \text{factor} \cdot V;$$

$$\delta_{V\infty} = \delta_{V\infty} - \text{factor} \cdot V;$$

Den Braven Chemical anchor PURE EPOXY for concrete

Performances
Displacements (threaded rods)

Annex C 13

Table C15: Displacements under tension load¹⁾ (rebar)

Anchor size reinforcing bar			Ø 8	Ø 10	Ø 12	Ø 14	Ø 16	Ø 20	Ø 25	Ø 28	Ø 32
Non-cracked concrete C20/25 under static and quasi-static action											
40°C/24°C ²⁾	δ _{N0} – factor	[mm/(N/mm ²)]	0,011	0,013	0,015	0,018	0,020	0,024	0,030	0,033	0,037
	δ _{N∞} – factor	[mm/(N/mm ²)]	0,044	0,052	0,061	0,070	0,079	0,096	0,118	0,132	0,149
60°C/43°C ²⁾	δ _{N0} – factor	[mm/(N/mm ²)]	0,013	0,015	0,018	0,020	0,023	0,028	0,034	0,038	0,043
	δ _{N∞} – factor	[mm/(N/mm ²)]	0,050	0,060	0,070	0,081	0,091	0,111	0,136	0,151	0,172
Cracked concrete C20/25 under static, quasi-static and seismic C1 action											
40°C/24°C ²⁾	δ _{N0} – factor	[mm/(N/mm ²)]	No Performance Determined (NPD)	0,032	0,035	0,037	0,042	0,049	0,055	0,061	
	δ _{N∞} – factor	[mm/(N/mm ²)]		0,21	0,21	0,21	0,21	0,21	0,21	0,21	
60°C/43°C ²⁾	δ _{N0} – factor	[mm/(N/mm ²)]		0,037	0,040	0,043	0,049	0,056	0,063	0,070	
	δ _{N∞} – factor	[mm/(N/mm ²)]		0,24	0,24	0,24	0,24	0,24	0,24	0,24	

¹⁾ Calculation of the displacement

$$\delta_{N0} = \delta_{N0} - \text{factor} \cdot \tau;$$

$$\delta_{N\infty} = \delta_{N\infty} - \text{factor} \cdot \tau;$$

Table C16: Displacement under shear load¹⁾ (rebar)

Anchor size reinforcing bar			Ø 8	Ø 10	Ø 12	Ø 14	Ø 16	Ø 20	Ø 25	Ø 28	Ø 32
For concrete C20/25 under static, quasi-static and seismic C1 action											
All temperatures	δ _{V0} – factor	[mm/(kN)]	0,06	0,05	0,05	0,04	0,04	0,04	0,03	0,03	0,03
	δ _{V∞} – factor	[mm/(kN)]	0,09	0,08	0,08	0,06	0,06	0,05	0,05	0,04	0,04

¹⁾ Calculation of the displacement

$$\delta_{V0} = \delta_{V0} - \text{factor} \cdot V;$$

$$\delta_{V\infty} = \delta_{V\infty} - \text{factor} \cdot V;$$

Den Braven Chemical anchor PURE EPOXY for concrete

Application with reinforcing bar
Displacements

Annex C 14