

Approval body for construction products
and types of construction

Bautechnisches Prüfamt

An institution established by the Federal and
Laender Governments



European Technical Assessment

ETA-16/0488
of 6 July 2016

English translation prepared by DIBt - Original version in German language

General Part

Technical Assessment Body issuing the
European Technical Assessment:

Deutsches Institut für Bautechnik

Trade name of the construction product

SMART nail anchor S-NA

Product family
to which the construction product belongs

Load controlled expansion anchor for
multiple use for non-structural applications
in concrete

Manufacturer

pgb - Polska Sp. z o.o.
ul. Jondy 5
44-100 GLIWICE
POLEN

Manufacturing plant

pgb-Polska plant 4

This European Technical Assessment
contains

10 pages including 3 annexes which form an integral part
of this assessment

This European Technical Assessment is
issued in accordance with Regulation (EU)
No 305/2011, on the basis of

Guideline for European technical approval of "Metal
anchors for use in concrete", ETAG 001 Part 6: "Anchors
for multiple use for non-structural applications", August
2010,
used as European Assessment Document (EAD)
according to Article 66 Paragraph 3 of Regulation (EU)
No 305/2011.

The European Technical Assessment is issued by the Technical Assessment Body in its official language. Translations of this European Technical Assessment in other languages shall fully correspond to the original issued document and shall be identified as such.

Communication of this European Technical Assessment, including transmission by electronic means, shall be in full. However, partial reproduction may only be made with the written consent of the issuing Technical Assessment Body. Any partial reproduction shall be identified as such.

This European Technical Assessment may be withdrawn by the issuing Technical Assessment Body, in particular pursuant to information by the Commission in accordance with Article 25(3) of Regulation (EU) No 305/2011.

Specific Part

1 Technical description of the product

The SMART Nail Anchor S-NA is an anchor made of galvanised steel, stainless steel (marking "A4") or high corrosion resistant steel 1.4529/1.4565 (marking "HCR") which is pushed into a drilled hole and expanded by loading. The anchor head is provided with connecting thread M6 or M8, with nail head, a coupling nut or with a loop, respectively.

The product description is given in Annex A.

2 Specification of the intended use in accordance with the applicable European Assessment Document

The performances given in Section 3 are only valid if the anchor is used in compliance with the specifications and conditions given in Annex B.

The verifications and assessment methods on which this European Technical Assessment is based lead to the assumption of a working life of the anchor of at least 50 years. The indications given on the working life cannot be interpreted as a guarantee given by the producer, but are to be regarded only as a means for choosing the right products in relation to the expected economically reasonable working life of the works.

3 Performance of the product and references to the methods used for its assessment

3.1 Mechanical resistance and stability (BWR 1)

Essential characteristic	Performance
Characteristic values	See Annex C 1

3.2 Safety in case of fire (BWR 2)

Essential characteristic	Performance
Reaction to fire	Anchorage satisfy requirements for Class A1
Resistance to fire	See Annex C 2

3.3 Safety in use (BWR 4)

The essential characteristics regarding Safety in use are included under the Basic Works Requirement Mechanical resistance and stability.

4 Assessment and verification of constancy of performance (AVCP) system applied, with reference to its legal base

In accordance with guideline for European technical approval ETAG 001, August 2010, used as European Assessment Document (EAD) according to Article 66 Paragraph 3 of Regulation (EU) No 305/2011, the applicable European legal act is: [97/161/EC].

The system to be applied is: 2+

English translation prepared by DIBt



5 Technical details necessary for the implementation of the AVCP system, as provided for in the applicable European Assessment Document

Technical details necessary for the implementation of the AVCP system are laid down in the control plan deposited at Deutsches Institut für Bautechnik.

Issued in Berlin on 6 July 2016 by Deutsches Institut für Bautechnik

Uwe Bender
Head of Department

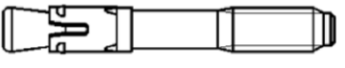
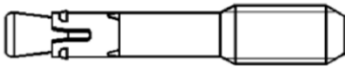
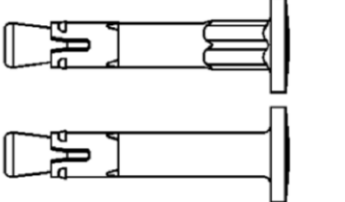
beglaubigt:
Baderschneider

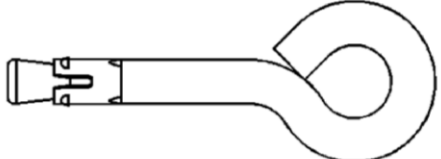
Anchor versions:	Marking (examples)	Explanation
N 6 Thread M6 	Marking of length e.g.: \textcircled{B} see table below ◇ N6 5/10 ◇ N6 5 A4 ◇ N8 5/10 ◇ N8 5 A4	N 6 Thread size M6 8 Thread size M8
N 8 Thread M8 		
N-K Nail head 	◇ N 5 10 ◇ N 5 A4	5 Max. thickness of fixture for $h_{ef} = 30$ mm 10 Max. thickness of fixture for $h_{ef} = 25$ mm (internal use only)
N-M Coupling Nut M8/M10, M8/M12 	◇ N8 5/10 ◇ N8 5 A4	A4 Additional marking of stainless steel A4 HCR Additional marking of high corrosion resistant steel HCR
N-O Loop 	◇ NO	O Anchor version: Loop

Anchor identifier	Marking		Thickness of fixture at $h_{ef} =$	
	Steel zinc plated, A4, HCR	Steel zinc plated only	30 mm	25 mm ¹⁾
A	0	/ 5	0	5
B	5	/ 10	5	10
C	10	/ 15	10	15
D	15	/ 20	15	20
E	20	/ 25	20	25
F	25	/ 30	25	30
G	30	/ 35	30	35
H	35	/ 40	35	40
I	40	/ 45	40	45
J	45	/ 50	45	50
K	50	/ 55	50	55
L	55	/ 60	55	60
M	60	/ 65	60	65

¹⁾ for internal use only

Anchor identifier	Marking		Thickness of fixture at $h_{ef} =$	
	Steel zinc plated, A4, HCR	Steel zinc plated only	30 mm	25 mm ¹⁾
N	65	/ 70	65	70
O	70	/ 75	70	75
P	75	/ 80	75	80
Q	80	/ 85	80	85
R	85	/ 90	85	90
S	90	/ 95	90	95
T	95	/ 100	95	100
U	100	/ 105	100	105
V	105	/ 110	105	110
W	110	/ 115	110	115
X	115	/ 120	115	120
Y	120	/ 125	120	125
Z	125	/ 130	125	130

SMART Nail Anchor S-NA

Product description
Anchor types and marking

Annex A1

Specifications of intended use

Anchorage subject to:

- static and quasi-static loads

Base materials:

- reinforced or unreinforced normal weight concrete according to EN 206-1:2000
- strength classes C12/15 to C50/60 according to EN 206-1:2000
- cracked and non-cracked concrete

Use conditions (environmental conditions):	Effective anchorage depth
<ul style="list-style-type: none"> • Structures subject to dry internal conditions; (zinc plated steel, stainless steel or high corrosion resistant steel). 	$h_{ef} \geq 30\text{mm}$ and $h_{ef,red} \geq 25\text{mm}$
<ul style="list-style-type: none"> • Structures subject to permanently damp internal conditions, if no particular aggressive conditions exist; (stainless steel or high corrosion resistant steel). 	$h_{ef} \geq 30\text{mm}$ and $h_{ef,red} \geq 25\text{mm}$
<ul style="list-style-type: none"> • Structures subject to external atmospheric exposure including industrial and marine environment, if no particular aggressive conditions exist; (stainless steel or high corrosion resistant steel). 	$h_{ef} \geq 30\text{mm}$
<ul style="list-style-type: none"> • Structures subject to external atmospheric exposure and to permanently damp internal condition, if other particular aggressive conditions; (high corrosion resistant steel). 	$h_{ef} \geq 30\text{mm}$

Note: Particular aggressive conditions are e.g. permanent, alternating immersion in seawater or the splash zone of seawater, chloride atmosphere of indoor pools or atmosphere with extreme chemical pollution (e.g. in desulphurization plants or road tunnels where de-icing materials are used.)

Design:

- Anchorages are designed under the responsibility of an engineer experienced in anchorages and concrete work.
- Verifiable calculation notes and drawings are prepared taking account of the loads to be anchored. The position of the anchor is indicated on the design drawings (e.g. position of the anchor relative to reinforcement or to supports, etc.).
- The design of the fixture is such that in case of excessive slip or failure of one anchor the load can be transmitted to neighbouring anchors.
- Anchorages under static or quasi-static actions for multiple use in non-structural applications are designed in accordance with:
 - ETAG 001, Annex C, Edition August 2010, design method C or
 - CEN/TS 1992-4: 2009, design method C
- Fasteners are only to be used for multiple use for non-structural application, according to ETAG 001 Part 6, Edition August 2010.
- Anchorages under fire exposure are designed in accordance with:
 - EOTA Technical Report TR 020, Edition May 2004 or
 - CEN/TS 1992-4: 2009, Annex D
 - It must be ensured that local spalling of the concrete cover does not occur.

Installation:

- Anchor installation carried out by appropriately qualified personnel and under the supervision of the person responsible for technical matters of the site,
- Anchor installation in accordance with the manufacturer's specifications and drawings and using the appropriate tools,
- Hammer drilling only,
- Anchor installation such that the effective setting depth is complied with. This compliance is ensured, if the admissible thickness of fixture is kept or the loop of Nail Anchor N-O rests on the concrete surface.

SMART Nail Anchor S-NA

Intended use
Specifications

Annex B1

Table B1: Installation parameters

Anchor type			N 6 N-K N-O	N 8 N-M	N 6 N-K N-O	N 8 N-M
Effective anchorage depth	$h_{ef} \geq$	[mm]	25 ¹⁾		30	
Nominal drill hole diameter	d_0	[mm]	6	6	6	6
Cutting diameter of drill bit	$d_{cut} \leq$	[mm]	6,40	6,40	6,40	6,40
Depth of drill hole	$h_1 \geq$	[mm]	35	35	40	40
Diameter of clearance hole in the fixture	$d_f \leq$	[mm]	7	9	7	9
Maximum tightening torque (N 6 and N 8 only)	$T_{inst} \leq$	[Nm]	4	4	4	4
Minimum member thickness	h_{min}	[mm]	80	80	80	80

¹⁾ Internal use only

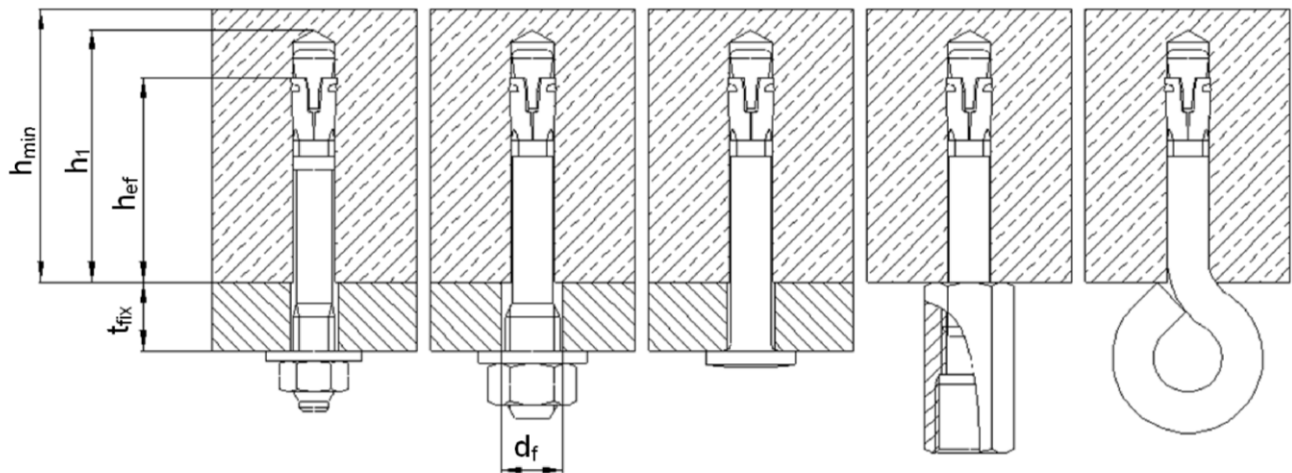













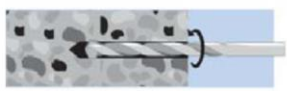



SMART Nail Anchor S-NA

Intended use
Installation parameters

Annex B2

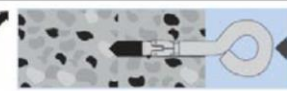
Installation instructions

N-K					Drill a hole 90° to concrete surface	Blow out dust	Drive-in the anchor by hammering	Anchor is placed
N6 / N8					Drill a hole 90° to concrete surface	Blow out dust	Check nut position and drive-in the anchor by hammering	Max tightening torque $T_{inst} \leq 4Nm$. Anchor is placed
N-M					Drill a hole 90° to concrete surface	Blow out dust	Check nut position and drive-in the anchor by hammering	Anchor is placed
N-O					Drill a hole 90° to concrete surface	Blow out dust	Drive-in the anchor by hammering	Anchor is placed

SMART Nail Anchor S-NA

Intended use
Installation instructions

Annex B3

Table C1: Characteristic and design resistance for a fixing point ¹⁾, design method C

Anchor types			N 6	N 8 N-K N-M	N-O	N 6	N 8 N-K N-M	N-O
Effective anchorage depth	$h_{ef} \geq$	[mm]	25			30		
Partial safety factor for any direction	γ_M	-	1,5					
Optimized for maximum load								
Characteristic resistance C12/15	F_{Rk}	[kN]	3,0	3,0 ⁴⁾	1,5	4,0	4,0 ⁴⁾	1,5
Characteristic resistance C20/25 to C50/60			4,5	4,5 ⁴⁾		5,9	5,9 ⁴⁾	
Design resistance C12/15	F_{Rd}	[kN]	2,0	2,0 ⁴⁾	1,0	2,7	2,7 ⁴⁾	1,0
Design resistance C20/25 to C50/60			3,0	3,0 ⁴⁾		3,9	3,9 ⁴⁾	
Respective spacing between fixing points ^{1) 2)}	$\frac{s_{cr}}{\text{for } c_{cr} \geq}$	[mm]	100					
			200					
Respective edge distance ²⁾	$\frac{c_{cr}}{\text{for } s_{cr} \geq}$	[mm]	100					
			200					
Optimized for minimum edge distance								
Characteristic resistance C12/15	F_{Rk}	[kN]	1,5	1,5 ⁴⁾	1,5	2,0	2,0 ⁴⁾	1,5
Characteristic resistance C20/25 to C50/60			2,0	2,0 ⁴⁾		2,5	2,5 ⁴⁾	
Design resistance C12/15	F_{Rd}	[kN]	1,0	1,0 ⁴⁾	1,0	1,3	1,3 ⁴⁾	1,0
Design resistance C20/25 to C50/60			1,3	1,3 ⁴⁾		1,7	1,7 ⁴⁾	
Respective spacing between fixing points ¹⁾	$\frac{c_{cr}}{\text{for } s_{cr} \geq}$	[mm]	50					
			100					
Shear load with lever arm								
Characteristic resistance, steel zinc plated	$M^0_{Rk,s}$	[Nm]	9,2	12,7	³⁾	9,2	12,7	³⁾
Characteristic resistance, stainless steel A4/HCR			9,2	13,5	³⁾	9,2	13,5	³⁾
Partial safety factor	γ_{Ms}	-	1,25					

¹⁾ A fixing point is defined as:

- Single anchor,
- Double anchor group with a minimum spacing s of $50 \text{ mm} \leq s < s_{cr}$ or
- Quadruple anchor group with a minimum spacing s of $50 \text{ mm} \leq s < s_{cr}$

If the spacing in a fixing point is greater than or equal to the respective spacing in this table, the characteristic resistances apply to every single anchor.

²⁾ Intermediate values can be linearly interpolated.

³⁾ Proof against failure due to shear load with lever arm is not required.

⁴⁾ When applying a shear load to anchor version N-M, shear load with lever arm must be proven.

SMART Nail Anchor S-NA

Performance
Characteristic and design resistance

Annex C1

Table C2: Characteristic resistance for a fixing point ¹⁾ under **fire exposure** in concrete C20/25 to C50/60, design method C

Fire resistance class		N 6 N 8	N-K	N-M ³⁾	N-O	N 6 N 8	N-K	N-M ³⁾	N-O		
Effective anchorage depth	$h_{ef} \geq$	[mm]	25				30				
Load in any direction											
R 30	Characteristic resistance, steel zinc plated	$F_{Rk,fi}$	[kN]	0,6	0,6	0,6	0,2	0,9	0,9	0,8	-
R 60				0,6	0,6	0,6	0,2	0,7	0,8	0,7	-
R 90				0,5	0,6	0,6	0,1	0,5	0,6	0,6	-
R120				0,4	0,5	0,5	0,1	0,4	0,5	0,6	-
R 30	Characteristic resistance, stainless steel A4 / HCR	$F_{Rk,fi}$	[kN]	0,6	0,6	0,6	0,2	0,9	0,9	0,8	0,2
R 60				0,6	0,6	0,6	0,2	0,9	0,9	0,7	0,2
R 90				0,5	0,6	0,6	0,1	0,9	0,9	0,6	0,1
R120				0,4	0,5	0,5	0,1	0,7	0,7	0,6	0,1
R 30 – R 120	Edge distance	$c_{cr,fi}$	[mm]	50							
	Spacing	$s_{cr,fi}$	[mm]	100							
Shear load with lever arm											
R 30	Characteristic resistance, steel zinc plated	$M^0_{Rk,fi}$	[Nm]	0,7	1,0	0,7	²⁾	0,7	1,0	0,7	-
R 60				0,5	0,8	0,7	²⁾	0,5	0,8	0,7	-
R 90				0,4	0,5	0,6	²⁾	0,4	0,5	0,6	-
R120				0,3	0,4	0,5	²⁾	0,3	0,4	0,5	-
R 30	Characteristic resistance, stainless steel A4 / HCR	$M^0_{Rk,fi}$	[Nm]	1,4	2,1	0,7	²⁾	1,4	2,1	0,7	²⁾
R 60				1,1	1,5	0,7	²⁾	1,1	1,5	0,7	²⁾
R 90				0,7	1,0	0,6	²⁾	0,7	1,0	0,6	²⁾
R120				0,5	0,7	0,5	²⁾	0,5	0,7	0,5	²⁾

If the fire attack is from more than one side, the edge distance shall be ≥ 300 mm.

¹⁾ A fixing point is defined as:

- Single anchor,
- Double anchor group with a minimum spacing s of $50 \text{ mm} \leq s < s_{cr,fi}$ or
- Quadruple anchor group with a minimum spacing s of $50 \text{ mm} \leq s < s_{cr,fi}$

If the spacing in a fixing point is greater than or equal to the respective spacing in this table, the characteristic resistances apply to every single anchor.

²⁾ Proof against failure due to shear load with lever arm is not required.

³⁾ Only in connection with threaded rods M8, M10 or M12 minimum strength class 5.8. When applying shear load to this anchor version, shear load with lever arm must be proven.

SMART Nail Anchor S-NA

Performance
Characteristic resistance under fire exposure

Annex C2