

Approval body for construction products  
and types of construction

Bautechnisches Prüfamt

An institution established by the Federal and  
Laender Governments



## European Technical Assessment

ETA-16/0708  
of 26 August 2016

English translation prepared by DIBt - Original version in German language

### General Part

Technical Assessment Body issuing the  
European Technical Assessment:

Deutsches Institut für Bautechnik

Trade name of the construction product

NOVIPro Nail Anchor

Product family  
to which the construction product belongs

Anchor for multiple use for non-structural  
applications in concrete

Manufacturer

Saint-Gobain Building Distribution  
Deutschland GmbH  
Hafeninsel 9  
63067 Offenbach/Main  
DEUTSCHLAND

Manufacturing plant

Herstellwerk Saint-Gobain 1

This European Technical Assessment  
contains

8 pages including 3 annexes which form an integral part  
of this assessment

This European Technical Assessment is  
issued in accordance with Regulation (EU)  
No 305/2011, on the basis of

Guideline for European technical approval of "Metal  
anchors for use in concrete", ETAG 001 Part 6: "Anchors  
for multiple use for non-structural applications", August  
2010,  
used as European Assessment Document (EAD)  
according to Article 66 Paragraph 3 of Regulation (EU)  
No 305/2011.

**European Technical Assessment  
ETA-16/0708**

**Page 2 of 8 | 26 August 2016**

English translation prepared by DIBt

The European Technical Assessment is issued by the Technical Assessment Body in its official language. Translations of this European Technical Assessment in other languages shall fully correspond to the original issued document and shall be identified as such.

Communication of this European Technical Assessment, including transmission by electronic means, shall be in full. However, partial reproduction may only be made with the written consent of the issuing Technical Assessment Body. Any partial reproduction shall be identified as such.

This European Technical Assessment may be withdrawn by the issuing Technical Assessment Body, in particular pursuant to information by the Commission in accordance with Article 25(3) of Regulation (EU) No 305/2011.

## Specific Part

### 1 Technical description of the product

The NOVIPro Nail Anchor is an anchor made of zinc-plated steel which is placed into a drilled hole and anchored by deformation-controlled expansion.

The product description is given in Annex A.

### 2 Specification of the intended use in accordance with the applicable European Assessment Document

The performances given in Section 3 are only valid if the anchor is used in compliance with the specifications and conditions given in Annex B.

The verifications and assessment methods on which this European Technical Assessment is based lead to the assumption of a working life of the anchor of at least 50 years. The indications given on the working life cannot be interpreted as a guarantee given by the producer, but are to be regarded only as a means for choosing the right products in relation to the expected economically reasonable working life of the works.

### 3 Performance of the product and references to the methods used for its assessment

#### 3.1 Mechanical resistance and stability (BWR 1)

The essential characteristics regarding mechanical resistance and stability are included under the Basic Works Requirement Safety in use.

#### 3.2 Safety in case of fire (BWR 2)

Essential characteristic	Performance
Reaction to fire	Anchorage satisfy requirements for Class A1
Resistance to fire	See Annex C1

#### 3.3 Safety in use (BWR 4)

Essential characteristic	Performance
Characteristic resistance for all load directions	See Annex C1

### 4 Assessment and verification of constancy of performance (AVCP) system applied, with reference to its legal base

In accordance with guideline for European technical approval ETAG 001, August 2010, used as European Assessment Document (EAD) according to Article 66 Paragraph 3 of Regulation (EU) No 305/2011, the applicable European legal act is: [97/161/EC].

The system to be applied is: 2+

**5 Technical details necessary for the implementation of the AVCP system, as provided for in the applicable European Assessment Document**

Technical details necessary for the implementation of the AVCP system are laid down in the control plan deposited with Deutsches Institut für Bautechnik.

Issued in Berlin on 26 August 2016 by Deutsches Institut für Bautechnik

Uwe Bender  
Head of Department

*beglaubigt:*  
Baderschneider

**Only for multiple use for non-structural applications  
according to ETAG 001, Part 6, Annex 1**

Head marking: Identifying mark of the producer and anchor type

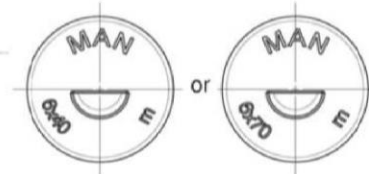
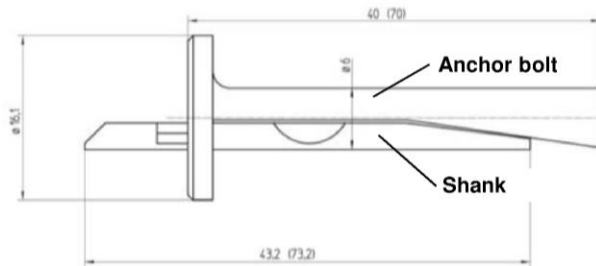

**Installed condition for NOVIPro Nail anchor**

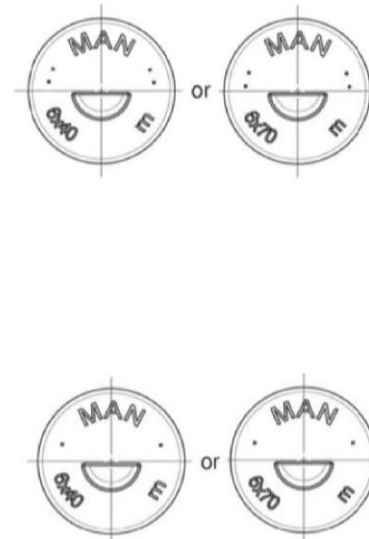
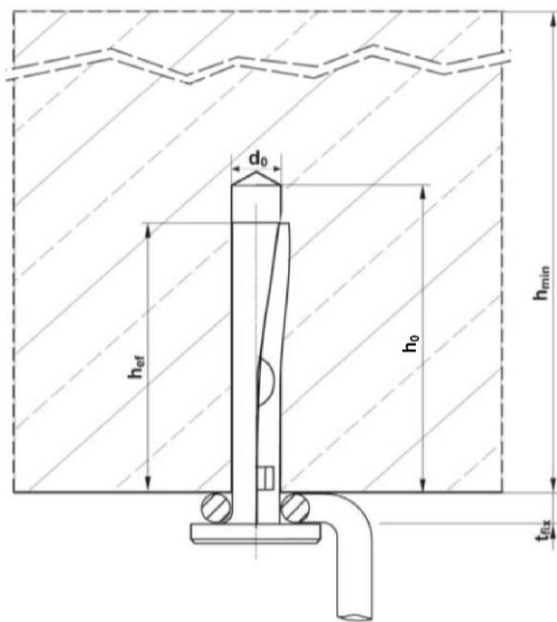

**Table A1: Anchor dimension, marking and material**

NOVIPro Nail anchor		6 x 40	6 x 70
Marking / embossing		MAN 6 x 40	MAN 6 x 70
Anchor length	[mm]	40	70
Material	Anchor bolt	Strength class 4.8 according to EN ISO 898-1:2013 galvanized steel, Zinc plating $\geq 5 \mu\text{m}$ according to EN ISO 4042:1999	
	Shank	Strength class 8.8 according to EN ISO 898-1:2013; galvanized steel, Zinc plating $\geq 5 \mu\text{m}$ according to EN ISO 4042:1999	

**NOVIPro Nail anchor**

**Product description**

Installed condition, anchor types, dimensions and materials

**Annex A1**

## Specifications of intended use

### Anchorage subject to:

- Static and quasi-static loads
- Multiple fixing of non-structural applications
- Fire exposure

### Base materials:

- Reinforced or unreinforced normal weight concrete according to EN 206-1:2000
- Strength classes C20/25 to C50/60 according to EN 206-1:2000
- Non-cracked and cracked concrete

### Use conditions:

- Structures subject to dry internal conditions

### Design:

- The anchorages are to be designed under the responsibility of an engineer experienced in anchorages and concrete work.
- Verifiable calculation notes and drawings shall be prepared taking account of the loads to be anchored, the nature and strength of the base materials and the dimensions of the anchorage members as well as of the relevant tolerances. The position of the anchor shall be indicated on the design drawings (e. g. position of the anchor relative to reinforcement or to supports, etc.).
- Anchorages under static or quasi-static actions are designed in accordance with ETAG 001, Annex C, design method C, Edition August 2010.
- Anchorages under fire exposure are designed in accordance with ETAG 001, Annex C, design Method C, Edition August 2010 and EOTA Technical Report TR 020, Edition May 2004. It must be ensured that local spalling of the concrete cover does not occur.
- Fasteners are only to be used for multiple use for non-structural application, according to ETAG 001 Part 6, Edition January 2011.

### Installation:

- Dry or wet concrete
- Anchor installation has to be carried out by appropriately qualified personnel according to Annex B2 under the supervision of the person responsible for technical matters of the site.
- Hole drilling by hammer drilling
- Anchor expansion by impact on the shank. The anchor is properly set, if no further driving by impact is possible and the excess of the shank is at maximum 2,5 mm.
- The anchor may only be set once.

**NOVIPro Nail anchor**

**Intended use  
Specifications**

**Annex B1**

**Table B1: Installation parameters**

NOVIPro Nail anchor			6 x 40	6 x 70
Effective anchorage depth	$h_{ef} \geq$	[mm]	32	
Thickness of fixture	$t_{fix}$	[mm]	0 - 5	0 - 35
Nominal drill hole diameter	$d_o$	[mm]	6	
Max. drill bit diameter	$d_{cut}$	[mm]	6,4	
Drill hole depth	$h_o \geq$	[mm]	40	
Minimum thickness of concrete member	$h_{min}$	[mm]	80	
Minimum spacing	$s_{min}$	[mm]	200	
Minimum edge distance	$c_{min}$	[mm]	150	

**Installation instructions:**



Make the drill hole

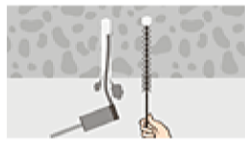

Clean the drill hole from drill dust

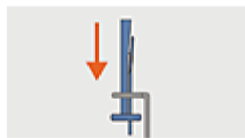

Place the fixture on the ceiling anchor

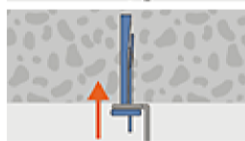

Place the ceiling anchor with the fixture concisely into the hole

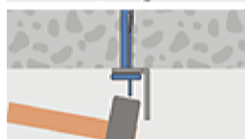

Drive in the nail with a hammer

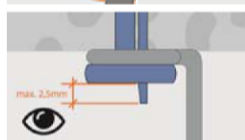

Installed ceiling anchor; control of maximum overlap of shank:  
 $\leq 2,5 \text{ mm}$

**NOVIPro Nail anchor**

**Intended use**

Installation parameters, edge distance and spacing  
Installation instructions

**Annex B2**

**Table C1: Characteristic values of resistance in concrete in all load directions (Design according to ETAG 001, Annex C, design method C)**

NOVIPro Nail anchor			6 x 40	6 x 70
<b>All load directions</b>				
Characteristic resistance in concrete C20/25 to C50/60	$F_{Rk}$	[kN]	3,0	
Installation safety factor	$\gamma_2$	[-]	1,0	
Minimum spacing	$s_{min}$	[mm]	200	
Minimum edge distance	$c_{min}$	[mm]	150	
<b>Shear load with lever arm</b>				
Characteristic bending moment	$M^0_{Rk,s}$ <sup>1)</sup>	[Nm]	5,4	
Installation safety factor	$\gamma_2$	[-]	1,0	

<sup>1)</sup> Characteristic bending moment  $M^0_{Rk,s}$  for Equation (5.5) in ETAG 001, Annex C

Only for multiple use for non-structural applications, the definition of multiple use according to the member states is given in the informative Annex 1 of ETAG 001, Part 6

**Table C2: Characteristic values under fire exposure in cracked and non-cracked concrete C20/25 to C50/60 in all load directions without lever arm (Design according to EOTA TR 020)**

Fire resistance class	NOVIPro Nail anchor			6 x 40	6 x 70
<b>R 30</b>	Characteristic resistance	$F^0_{Rk,fi}$ <sup>1)</sup>	[kN]	0,6	
<b>R 60</b>				0,5	
<b>R 90</b>				0,4	
<b>R 120</b>				0,3	
<b>R 30 - R 120</b>	Minimum spacing	$s_{min,fi}$	[mm]	200	
	Minimum edge distance <sup>2)</sup>	$c_{min,fi}$	[mm]	150	

<sup>1)</sup> In absence of other national regulations, the partial safety factor for resistance under fire exposure  $\gamma_{m,fi} = 1,0$  is recommended.

<sup>2)</sup> In case of fire attack from more than one side of the concrete member, the edge distance shall be  $\geq 300$  mm.

NOVIPro Nail anchor

**Performances**

Characteristic resistances in concrete  
Design method C according to ETAG 001, Annex C

**Annex C1**