

Approval body for construction products
and types of construction

Bautechnisches Prüfamt

An institution established by the Federal and
Laender Governments



European Technical Assessment

ETA-13/0470
of 1 June 2017

English translation prepared by DIBt - Original version in German language

General Part

Technical Assessment Body issuing the
European Technical Assessment:

Deutsches Institut für Bautechnik

Trade name of the construction product

Injection system Chemfix 500
for rebar connection

Product family
to which the construction product belongs

System for post installed rebar
connection with mortar

Manufacturer

CHEMFIX PRODUCTS LTD
Mill Street East
DEWSBURY, West Yorkshire WF12 9BQ
GROSSBRITANNIEN

Manufacturing plant

Chemfix Plant 2

This European Technical Assessment
contains

17 pages including 3 annexes which form an integral part
of this assessment

This European Technical Assessment is
issued in accordance with Regulation (EU)
No 305/2011, on the basis of

European Assessment Document (EAD)
330087-00-0601

This version replaces

ETA-13/0470 issued on 25 March 2014

**European Technical Assessment
ETA-13/0470**

Page 2 of 17 | 1 June 2017

English translation prepared by DIBt

The European Technical Assessment is issued by the Technical Assessment Body in its official language. Translations of this European Technical Assessment in other languages shall fully correspond to the original issued document and shall be identified as such.

Communication of this European Technical Assessment, including transmission by electronic means, shall be in full. However, partial reproduction may only be made with the written consent of the issuing Technical Assessment Body. Any partial reproduction shall be identified as such.

This European Technical Assessment may be withdrawn by the issuing Technical Assessment Body, in particular pursuant to information by the Commission in accordance with Article 25(3) of Regulation (EU) No 305/2011.

Specific Part

1 Technical description of the product

The subject of this European Technical Assessment is the post-installed connection, by anchoring or overlap connection joint, of reinforcing bars (rebars) in existing structures made of normal weight concrete, using the "Injection system Chemfix 500 for rebar connection" in accordance with the regulations for reinforced concrete construction.

Reinforcing bars made of steel with a diameter ϕ from 8 to 40 mm according to Annex A and injection mortar Chemfix 500 are used for rebar connections. The rebar is placed into a drilled hole filled with injection mortar and is anchored via the bond between rebar, injection mortar and concrete.

The product description is given in Annex A.

2 Specification of the intended use in accordance with the applicable European assessment Document

The performances given in Section 3 are only valid if the anchor is used in compliance with the specifications and conditions given in Annex B.

The verifications and assessment methods on which this European Technical Assessment is based lead to the assumption of a working life of the anchor of at least 50 years. The indications given on the working life cannot be interpreted as a guarantee given by the producer, but are to be regarded only as a means for choosing the right products in relation to the expected economically reasonable working life of the works.

3 Performance of the product and references to the methods used for its assessment

3.1 Mechanical resistance and stability (BWR 1)

Essential characteristic	Performance
Amplification factor α_{lb} , Bond resistance f_{bd}	See Annex C1

3.2 Safety in case of fire (BWR 2)

Essential characteristic	Performance
Reaction to fire	The products satisfy requirements for Class A1
Resistance to fire	See Annex C2

4 Assessment and verification of constancy of performance (AVCP) system applied, with reference to its legal base

In accordance with European Assessment Document EAD No. 330087-00-0601, the applicable European legal act is: [96/582/EC].

The system(s) to be applied is (are): 1

English translation prepared by DIBt

5 Technical details necessary for the implementation of the AVCP system, as provided for in the applicable EAD

Technical details necessary for the implementation of the AVCP system are laid down in the control plan deposited with Deutsches Institut für Bautechnik.

Issued in Berlin on 1 June 2017 by Deutsches Institut für Bautechnik

Andreas Kummerow
Head of Department

beglaubigt:
Baderschneider

Figure A1: Overlapping joint for rebar connections of slabs and beams

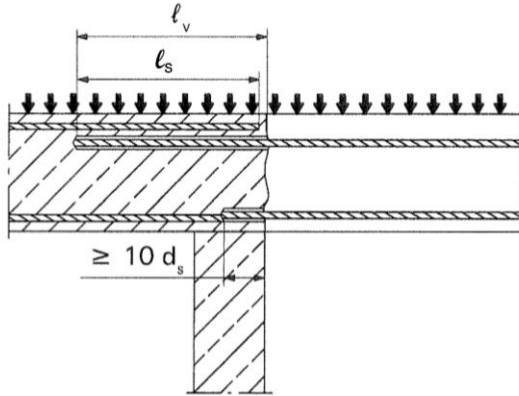

Figure A3: End anchoring of slabs or beams, designed as simply supported

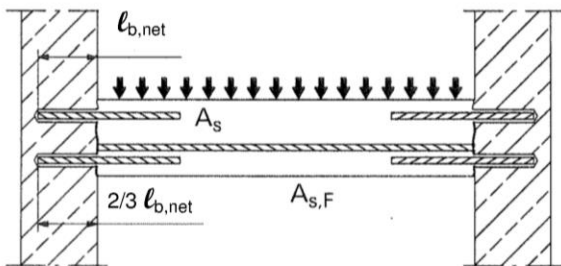

Figure A2: Overlapping joint at a foundation of a wall or column where the rebars are stressed in tension

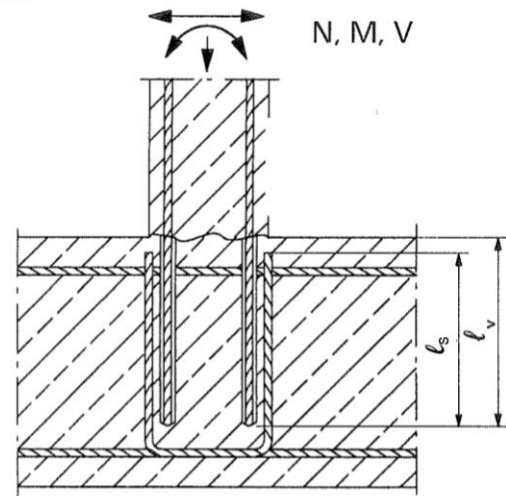

Figure A4: Rebar connection for components stressed primarily in compression. The rebars are stressed in compression

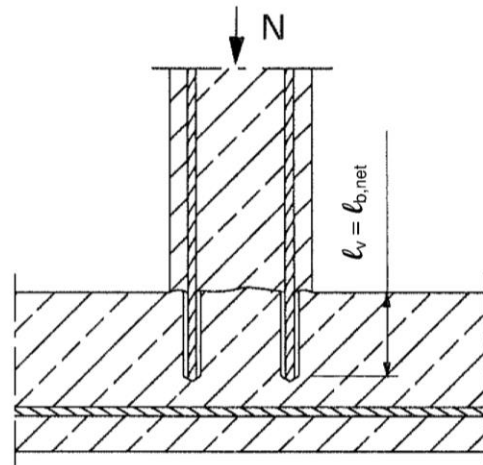
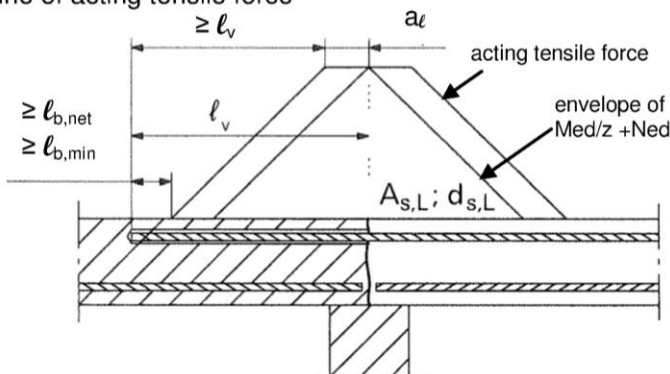

Figure A5: Anchoring of reinforcement to cover the line of acting tensile force



Note to Figure A1 to A5:

In the Figures no transverse reinforcement is plotted, the transverse reinforcement shall comply with EN 1992-1-1:2004+AC:2010.



Preparing of joints according to Annex B 2

Injection system Chemfix 500 for rebar connection

Product description

Installed condition and examples of use for rebars

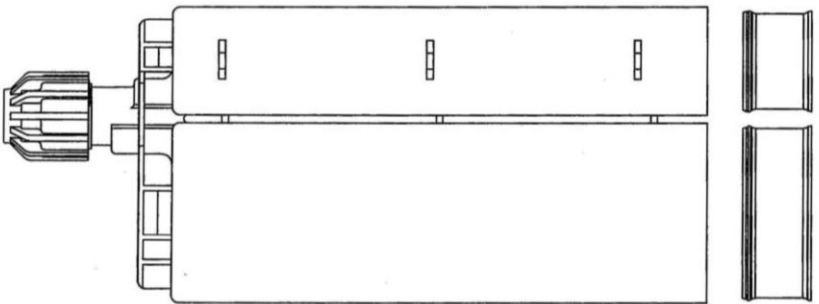
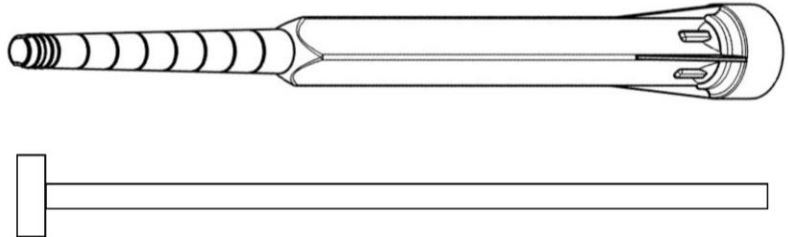
Annex A 1

Product description and intended use					
<p>Injection mortar: Chemfix 500</p> <p>Typ "side-by-side": 385 ml, 585 ml, 1000 ml and 1400 ml</p>	 <p>Label: Chemfix 500, processing notes, charge-code, shelf life, hazard-code, curing- and processing time (depending on the temperature), with as well as without travel scale</p>				
<p>Static Mixer</p> <p>Piston plug and mixer extension</p>					
<p>Reinforcing bar (rebar): ø8, ø10, ø12, ø14, ø16, ø20, ø22, ø24, ø25, ø28, ø32, ø34, ø36, ø40</p>					
					
<p>Minimum value of related rip area $f_{R,min}$ according to EN 1992-1-1:2004+AC:2010</p> <ul style="list-style-type: none"> Rib height of the bar shall be in the range $0,05d \leq h \leq 0,07d$ (d: Nominal diameter of the bar; h: Rip height of the bar) 					
<p>Table A1: Materials</p> <table border="1"> <thead> <tr> <th>Designation</th> <th>Material</th> </tr> </thead> <tbody> <tr> <td>Rebar EN 1992-1-1:2004+AC:2010, Annex C</td> <td>Bars and de-coiled rods class B or C f_{yk} and k according to NDP or NCL of EN 1992-1-1/NA:2013 $f_{tk} = f_{tk} = k \cdot f_{yk}$</td> </tr> </tbody> </table>		Designation	Material	Rebar EN 1992-1-1:2004+AC:2010, Annex C	Bars and de-coiled rods class B or C f_{yk} and k according to NDP or NCL of EN 1992-1-1/NA:2013 $f_{tk} = f_{tk} = k \cdot f_{yk}$
Designation	Material				
Rebar EN 1992-1-1:2004+AC:2010, Annex C	Bars and de-coiled rods class B or C f_{yk} and k according to NDP or NCL of EN 1992-1-1/NA:2013 $f_{tk} = f_{tk} = k \cdot f_{yk}$				
<p>Injection system Chemfix 500 for rebar connection</p>					
<p>Product description Injection mortar / Static mixer / Rebar Materials</p>	<p>Annex A 2</p>				

Specifications of intended use

Anchorage subject to:

- Static and quasi-static loads.
- Fire exposure

Base materials:

- Reinforced or unreinforced normal weight concrete according to EN 206-1:2000.
- Strength classes C12/15 to C50/60 according to EN 206-1:2000.
- Maximum chloride concrete of 0,40% (CL 0.40) related to the cement content according to EN 206-1:2000.
- Non-carbonated concrete.

Note: In case of a carbonated surface of the existing concrete structure the carbonated layer shall be removed in the area of the post-installed rebar connection with a diameter of $\phi + 60$ mm prior to the installation of the new rebar.

The depth of concrete to be removed shall correspond to at least the minimum concrete cover in accordance with EN 1992-1-1:2004+AC:2010.

The foregoing may be neglected if building components are new and not carbonated and if building components are in dry conditions.

Temperature Range:

- - 40°C to +80°C (max. short term temperature +80°C and max long term temperature +50°C).

Design:

- Anchorages are designed under the responsibility of an engineer experienced in anchorages and concrete work.
- Verifiable calculation notes and drawings are prepared taking account of the forces to be transmitted.
- The actual position of the reinforcement in the existing structure shall be determined on the basis of the construction documentation and taken into account when designing.
- Anchorages under static or quasi-static actions are designed in accordance with EN 1992-1-1:2004+AC:2010 and Annex B2.
- Anchorages under fire exposure are designed in accordance with EN 1992-1-2:2004+AC:2008.

Installation:

- Dry or wet concrete.
- It must not be installed in flooded holes.
- Hole drilling by hammer drill, compressed air drill or diamond drill mode.
- The installation of post-installed rebar shall be done only by suitable trained installer and under supervision on site; the conditions under which an installer may be considered as suitable trained and the conditions for supervision on site are up to the Member States in which the installation is done.
- Check the position of the existing rebars (if the position of existing rebars is not known, it shall be determined using a rebar detector suitable for this purpose as well as on the basis of the construction documentation and then marked on the building component for the overlap joint).

Injection system Chemfix 500 for rebar connection

Intended use
Specifications

Annex B 1

Figure B1: General design rules of construction for post-installed in rebars

- Only tension forces in the axis of the rebar may be transmitted
- The transfer of shear forces between new concrete and existing structure shall be designed additionally according to EN 1992-1-1:2004+AC:2010.
- The joints for concreting must be roughened to at least such an extent that aggregate protrude.

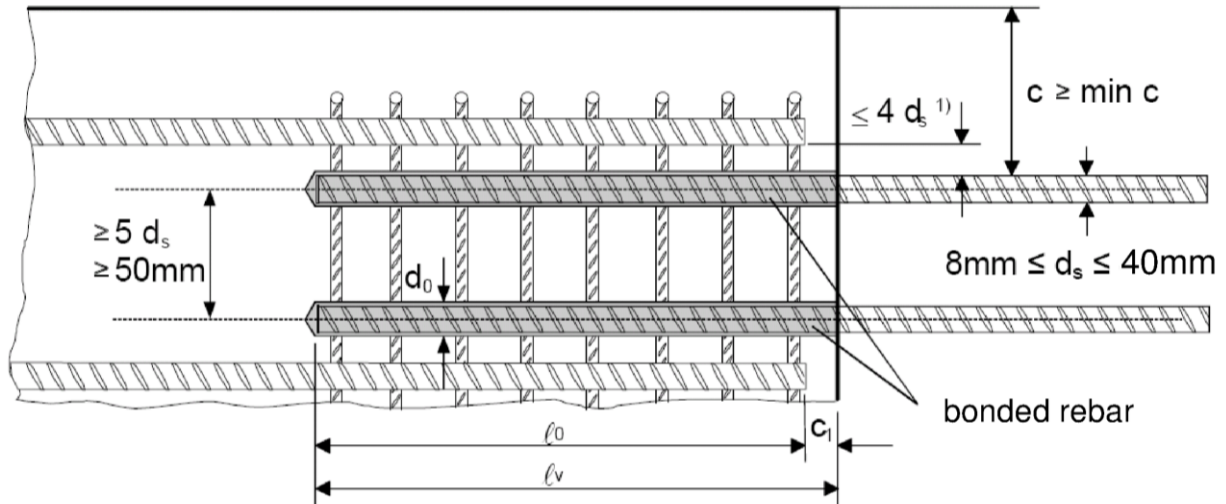

- 1) If the clear distance between lapped bars exceeds $4d_s$, then the lap length shall be increased by the difference between the clear bar distance and $4d_s$.

The following applies to Figure B1:

c	concrete cover of post-installed rebar
c_1	concrete cover at end-face of existing rebar
min c	minimum concrete cover according to Table B1 and to EN 1992-1-1:2004+AC:2010, Section 4.4.1.2
d_s	diameter of post-installed rebar
l_0	lap length, according to EN 1992-1-1:2004+AC:2010, Section 8.7.3
l_v	effective embedment depth, $\geq l_0 + c_1$
d_0	nominal drill bit diameter, see Annex B 3

Injection system Chemfix 500 for rebar connection

Intended use
General construction rules for post-installed rebars

Annex B 2

Table B1: Minimum concrete cover min c of bonded-in rebar depending of drilling method

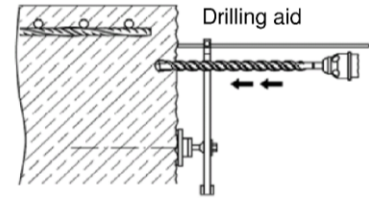

Drilling method	Rebar diameter	Without drilling aid	With drilling aid
Hammer drilling (HD)	< 25 mm	30 mm + 0,06 · l _v ≥ 2 d _s	30 mm + 0,02 · l _v ≥ 2 d _s
	≥ 25 mm	40 mm + 0,06 · l _v ≥ 2 d _s	40 mm + 0,02 · l _v ≥ 2 d _s
Compressed air drilling (CD)	< 25 mm	50 mm + 0,08 · l _v	50 mm + 0,02 · l _v
	≥ 25 mm	60 mm + 0,08 · l _v	60 mm + 0,02 · l _v
Diamond coring (DD)	< 25 mm	Drill stand used as drilling aid	30 mm + 0,02 · l _v ≥ 2 φ
	≥ 25 mm		40 mm + 0,02 · l _v ≥ 2 φ

¹⁾ see Annexes B2, Figures B1
Comments: The minimum concrete cover acc. EN 1992-1-1:2004+AC:2010 must be observed

Table B2: Bore hole diameter and maximum embedment depth l_{max}

Bar size φ (mm)	Drill bit - Ø (mm)			Cartridge: side-by-side (385, 585, 1000, 1400 ml)	Cartridge: side-by-side (385, 585 ml)	Cartridge: side-by-side (1000, 1400 ml)
				Hand or battery tool	Pneumatic tool	Pneumatic tool
	HD	CD	DD	l _{v,max} (mm)	l _{v,max} (mm)	l _{v,max} (mm)
8	12	-	12	700	800	800
10	14	-	14		1000	1000
12	16				1200	1200
14	18				1400	1400
16	20				1500	1600
20	25	26	25		500	1000
22	28			700		
24	32					
25	32			500		
28	35					
32	40					
34	40			-	500	
36	45					
40	55	55	52			

Injection system Chemfix 500 for rebar connection

Intended use
Minimum concrete cover
Maximum embedment depth

Annex B 3





Table B3: Base material temperature, gelling time and curing time

Concrete temperature	Gelling- / working time ¹⁾	Minimum curing time in dry concrete ²⁾
	t_{gel}	$t_{cure,dry}$
+5°C to +9°C	120 min	50 h
+10°C to +19°C	90 min	30 h
+20°C to +29°C	30 min	10 h
+30°C to +39°C	20 min	6 h
+40 °C	12 min	4 h

¹⁾ t_{gel} : maximum time from starting of mortar injection to completing of rebar setting.

²⁾ In wet concrete the curing time $t_{cure,dry}$ has to be doubled up

Table B4: Dispensing tools

Cartridge type/size	Hand tool	Pneumatic tool
Side-by-side cartridges 385, 585 ml	 e.g. SA 296C585	 e.g. Type TS 444 KX
Side-by-side cartridge 1000 ml	-	 e.g. Type TS 4104
Side-by-side cartridge 1400 ml	-	 e.g. Type TS 471

All cartridges could also be extruded by a battery tool.

Injection system Chemfix 500 for rebar connection

Intended Use
working time and curing times
Dispensing tools

Annex B 4

Table B5: Installation tools

Bar size ϕ	Drill and clean					Installation			
	Drill bit - ϕ			Brush	min Brush - ϕ	Air Nozzle	Piston plug	Mixer extension	Max embedment depth
	HD	PD	DD		$d_{b,min}$				l_v or $l_{e,ges}$
[mm]	[mm]			RB	[mm]	AN	VS	VL	[mm]
8	12	-	12	14	12,5	10	-	VL 10/0,75 or VL 16/1,8	800
10	14	-	14	16	14,5		14		1000
12	16			18	16,5	14	16		1200
14	18			20	18,5		18		1400
16	20			22	20,5	17	20		1600
20	25	-	25	27	25,5		25		2000
	-	26	-	27	26,5	25	2000		
22	28			30	28,5	27	28		2000
24	32			34	32,5		32		2000
25	32			34	32,5		32		2000
28	35			37	35,5		35		2000
32	40			42	40,5		40		2000
34	40			42	40,5		40	2000	
36	45			47	45,5	40	45	2000	
40	-	-	52	54	52,5		52	2000	
	55	55	-	58	55,5		55	2000	

Brush RB:

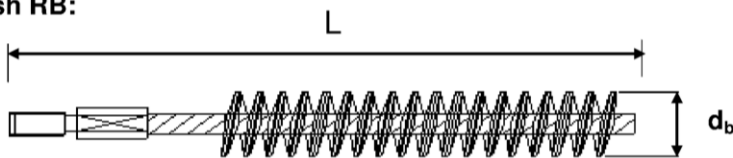

SDS Plus Adapter:



Rec. compressed air tool
hand slide valve (min 6 bar)

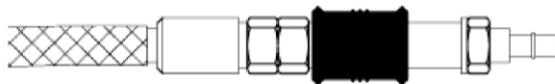

Hand pump (volume 750 ml)



Air nozzle AN:

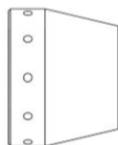

Brush extension:



Injection system Chemfix 500 for rebar connection

Intended use
Installation tools

Annex B 5

A) Bore hole drilling

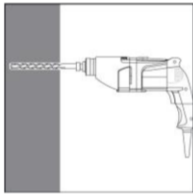

1. Drill a hole into the base material to the size and embedment depth required by the selected reinforcing bar with carbide hammer drill (HD), a compressed air drill (CD) or diamond core (DD). In case of aborted drill hole: the drill hole shall be filled with mortar. Drill bit sizes see Table B5.



Hammer drilling (HD)

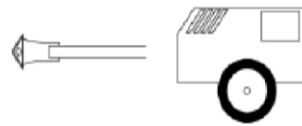

Compressed air drilling (CD)



Diamond coring (DD)

B1) Bore hole cleaning (HD and CD)

Attention! Standing water in the bore hole must be removed before cleaning.

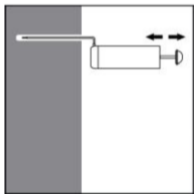

or



- 2a. Starting from the bottom or back of the bore hole, blow the hole clean with compressed air (min. 6 bar) or a hand pump a minimum of two times. If the bore hole ground is not reached an extension shall be used.

For bore holes deeper than 240 mm, compressed air (min. 6 bar **must** be used. For bore holes larger than 32 mm, compressed air (min. 6 bar) and the appropriate air nozzle (see Table B5) **must** be used.

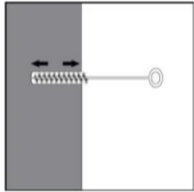

- 2b. Check brush diameter (Table B5) and attach the brush to a drilling machine or a battery screwdriver. Brush the hole with an appropriate sized wire brush $> d_{b,min}$ (Table B5) a minimum of two times. If the bore hole ground is not reached with the brush, a brush extension shall be used.

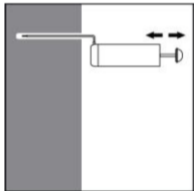

or

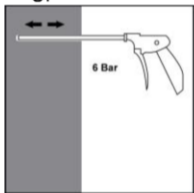

- 2c. Finally blow the hole clean again with compressed air (min. 6 bar) or a hand pump a minimum of two times. If the bore hole ground is not reached an extension shall be used.

For bore holes deeper than 240 mm, compressed air (min. 6 bar **must** be used. For bore holes larger than 32 mm, compressed air (min. 6 bar) and the appropriate air nozzle (see Table B5) **must** be used.

After cleaning, the bore hole has to be protected against re-contamination in an appropriate way, until dispensing the mortar in the bore hole. If necessary, the cleaning has to be repeated directly before dispensing the mortar. In-flowing water must not contaminate the bore hole again.

Injection system Chemfix 500 for rebar connection

Intended Use

Installation instruction: Bore hole drilling and
Bore hole cleaning

Annex B 6

B2) Bore hole cleaning (DD)

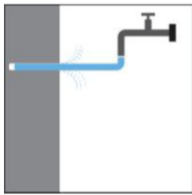

2a. Rinsing with water until clear water comes out.

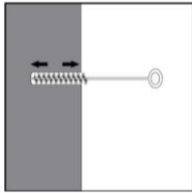

2b. Check brush diameter acc. Table B5 and attach the brush to a drilling machine or a battery screwdriver. Brush the hole with an appropriate sized wire brush $> d_{b,min}$ (Table B5) a minimum of two times. If the bore hole ground is not reached with the brush, a brush extension shall be used (Table B5).

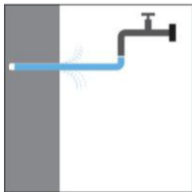

2c. Rinsing again with water until clear water comes out.

Attention! Standing water in the bore hole must be removed before cleaning.

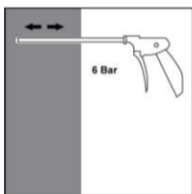

2d. Starting from the bottom or back of the bore hole, blow the hole clean with compressed air (min. 6 bar) with the appropriate air nozzle (see Table B5) a minimum of two times. If the bore hole ground is not reached an extension shall be used.

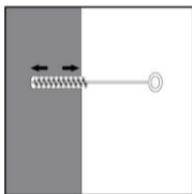

2e. Check brush diameter (Table B5) and attach the brush to a drilling machine or a battery screwdriver. Brush the hole with an appropriate sized wire brush $> d_{b,min}$ (Table B5) a minimum of two times. If the bore hole ground is not reached with the brush, a brush extension shall be used.

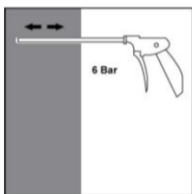

2f. Finally blow the hole clean again with compressed air (min. 6 bar) with the appropriate air nozzle (see Table B5) a minimum of two times. If the bore hole ground is not reached an extension shall be used.

After cleaning, the bore hole has to be protected against re-contamination in an appropriate way, until dispensing the mortar in the bore hole. If necessary, the cleaning has to be repeated directly before dispensing the mortar. In-flowing water must not contaminate the bore hole again.

Injection system Chemfix 500 for rebar connection

Intended Use

Installation instruction: Bore hole cleaning (DD)

Annex B 7

C) Preparation of bar and cartridge

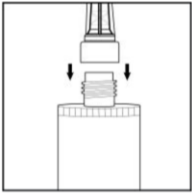

3. Attach the supplied static-mixing nozzle to the cartridge and load the cartridge into the correct dispensing tool.
For every working interruption longer than the recommended working time (Table B3) as well as for every new cartridges, a new static-mixer shall be used.



4. Prior to inserting the reinforcing bar into the filled bore hole, the position of the embedment depth shall be marked (e.g. with tape) on the reinforcing bar and insert bar in empty hole to verify hole and depth l_v .
The anchor should be free of dirt, grease, oil or other foreign material.



5. Prior to dispensing into the anchor hole, squeeze out separately the mortar until it shows a consistent grey colour, but a minimum of three full strokes, and discard non-uniformly mixed adhesive components.

D) Filling the bore hole

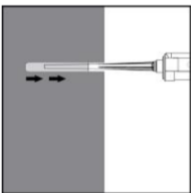

6. Starting from the bottom or back of the cleaned anchor hole fill the hole up to approximately two-thirds with adhesive. Slowly withdraw the static mixing nozzle as the hole fills to avoid creating air pockets. For embedment larger than 190 mm an extension nozzle shall be used.

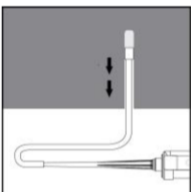

For overhead and horizontal installation and bore holes deeper than 240 mm a piston plug and the appropriate mixer extension must be used.

Observe the gel-/ working times given in Table B3.

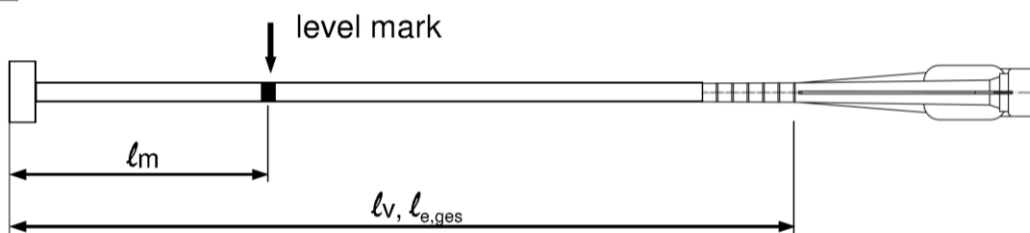

Injection tool must be marked by mortar level mark l_m and anchorage depth l_v resp. $l_{e,ges}$ with tape or marker.

Quick estimation: $l_m = 1/3 \cdot l_v$

Continue injection until the mortar level mark l_m becomes visible.

Optimum mortar volume: $l_m = l_v \text{ resp } l_{e,ges} \cdot \left(1,2 \cdot \frac{d_s^2}{d_0^2} - 0,2 \right)$ [mm]

Injection system Chemfix 500 for rebar connection

Intended Use
Preparation of bar and cartridge
Filling the bore hole

Annex B 8

E) Inserting the rebar



7. Push the reinforcing bar into the anchor hole while turning slightly to ensure positive distribution of the adhesive until the embedment depth is reached.

The bar should be free of dirt, grease, oil or other foreign material.

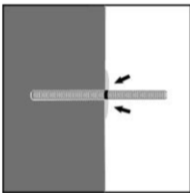

8. Be sure that the bar is inserted in the bore hole until the embedment mark is at the concrete surface and that excess mortar is visible at the top of the hole. If these requirements are not maintained, the application has to be renewed. For overhead installation fix embedded part (e.g. wedges).

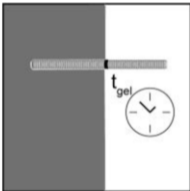

9. Observe gelling time t_{gel} . Attend that the gelling time can vary according to the base material temperature (see Table B3). It is not allowed to move the bar after gelling time t_{gel} has elapsed. Allow the adhesive to cure to the specified time prior to applying any load. Do not move or load the bar until it is fully cured (attend Table B3). After full curing time t_{cure} has elapsed, the add-on part can be installed.

Injection system Chemfix 500 for rebar connection

Annex B 9

Intended Use

Installation instruction: Inserting rebar

Minimum anchorage length and minimum lap length

The minimum anchorage length $\ell_{b,min}$ and the minimum lap length $\ell_{0,min}$ according to EN 1992-1-1:2004+AC:2010 ($\ell_{b,min}$ acc. to Eq. 8.6 and Eq. 8.7 and $\ell_{0,min}$ acc. to Eq. 8.11) shall be multiply by the amplification factor α_{lb} according to Table C1.

Table C1: Amplification factor α_{lb}

Concrete class	Drilling method	Bar size	Amplification factor α_{lb}
C12/15 to C50/60	Hammer drilling (HD) and compressed air drilling (CD)	8 mm to 32 mm	1,0
	Hammer drilling (HD) and compressed air drilling (CD)	> 32 mm	1,5
	Diamond coring (DD)	8 mm to 40 mm	1,5

Table C2: Design values of the ultimate bond resistance f_{bd} in N/mm² for hammer (HD) and compressed air drilling (CD) methods for good conditions

according to EN 1992-1-1:2004+AC:2010 for good bond conditions
(for all other bond conditions multiply the values by 0.7)

Rebar - \varnothing	Concrete class								
	C12/15	C16/20	C20/25	C25/30	C30/37	C35/45	C40/50	C45/55	C50/60
d_s									
8 to 32 mm	1,6	2,0	2,3	2,7	3,0	3,4	3,7	4,0	4,3
34 mm	1,6	2,0	2,3	2,6	2,9	3,3	3,6	3,9	4,2
36 mm	1,5	1,9	2,2	2,6	2,9	3,3	3,6	3,8	4,1
40 mm	1,5	1,8	2,1	2,5	2,8	3,1	3,4	3,7	4,0

Table C3: Design values of the ultimate bond resistance f_{bd} in N/mm² for Diamond coring (DD) method for good conditions

according to EN 1992-1-1:2004+AC:2010 for good bond conditions
(for all other bond conditions multiply the values by 0.7)

Rebar - \varnothing	Concrete class								
	C12/15	C16/20	C20/25	C25/30	C30/37	C35/45	C40/50	C45/55	C50/60
d_s									
8 to 28 mm	1,6	2,0	2,3	2,7	3,0	3,4	3,7	4,0	4,3
32 mm	1,6	2,0	2,3	2,7					
34 mm	1,6	2,0	2,3	2,6					
36 mm	1,5	1,9	2,2	2,6					
40 mm	1,5	1,8	2,1	2,5					

Injection system Chemfix 500 for rebar connection

Performances
Amplification factor
Design values of ultimate bond resistance f_{bd}

Annex C 1

Reduction factor $k_{fi}(\theta)$ for design in case of fire (all drilling methods)

according to EN 1992-1-2:2004 + AC:2008

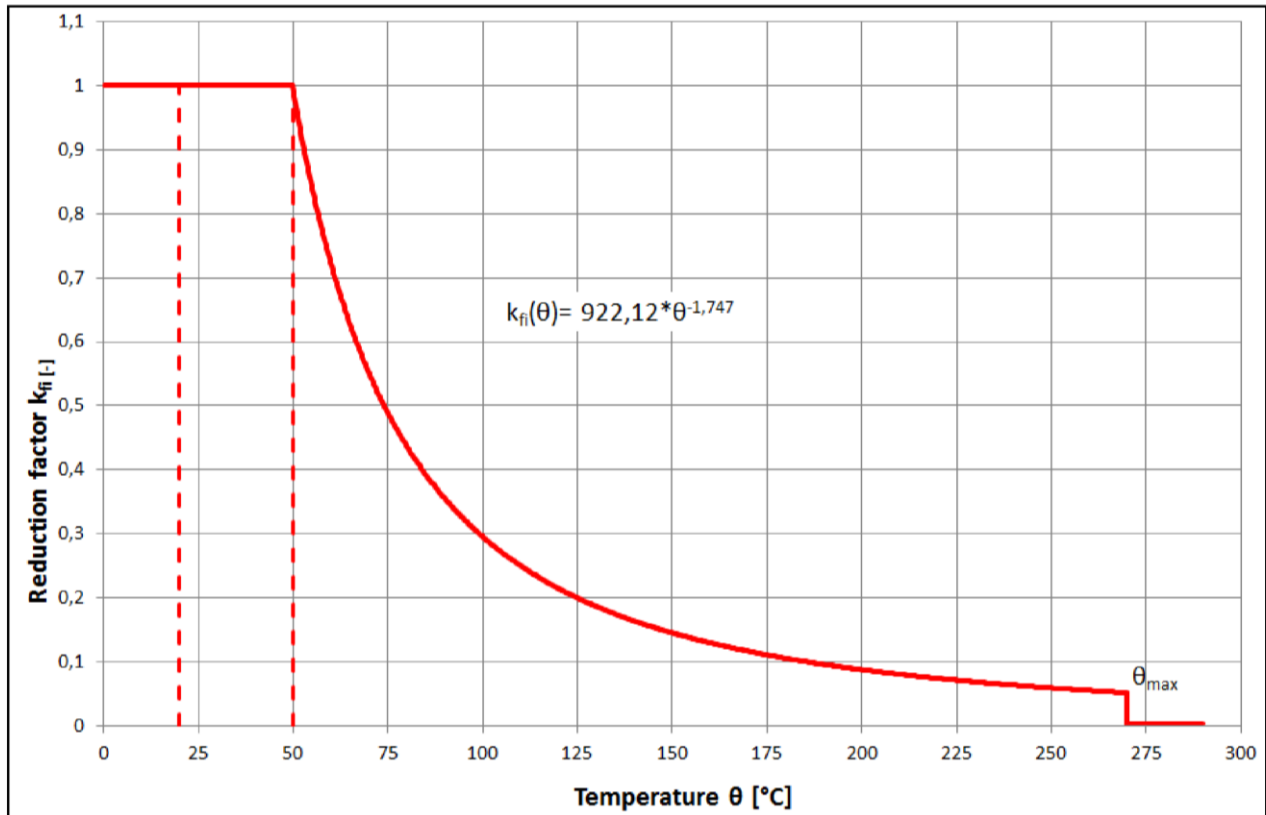

$$k_{fi}(\theta) = a \cdot \theta^b \quad \text{with } a = 922,12 \text{ and } b = -1,747$$

$$k_{fi}(\theta) < 1 \quad \text{for } 50^\circ\text{C} \leq \theta \leq 270^\circ\text{C}$$

$$k_{fi}(\theta) = 0 \quad \text{for } \theta > 270^\circ\text{C}$$

Design value of the bond strength $f_{bd,fi}$ under fire exposure

The design value of the bond strength $f_{bd,fi}$ under fire exposure will be calculated by the following equation:

$$f_{bd,fi} = k_{fi}(\theta) \cdot f_{bd} \cdot \gamma_c / \gamma_{M,fi}$$

with:

- $k_{fi}(\theta)$... Reduction factor under fire exposure, see Figure C4
- f_{bd} ... Design value of the bond strength according to Table C2 or C3
- $\gamma_c = 1,5$... recommended safety factor according to EN 1992-1-1
- $\gamma_{M,fi}$... safety factor according to EN 1992-1-2 under fire exposure

Injection system Chemfix 500 for rebar connection

Performances
Reduction factor $k_{fi}(\theta)$ for design in case of fire

Annex C 2