

Approval body for construction products
and types of construction

Bautechnisches Prüfamt

An institution established by the Federal and
Laender Governments



European Technical Assessment

ETA-13/0612
of 6 October 2017

English translation prepared by DIBt - Original version in German language

General Part

Technical Assessment Body issuing the
European Technical Assessment:

Deutsches Institut für Bautechnik

Trade name of the construction product

DRIZORO S.A.U. MAXFIX-ER Injection Adhesive

Product family
to which the construction product belongs

Bonded anchor for use in concrete

Manufacturer

DRIZORO S.A.
Industrial Las Monjas
C/ Primavera 50-52
28850 TORREJON DE ARDOZ
SPANIEN

Manufacturing plant

DRIZORO Manufacturing Facilities

This European Technical Assessment
contains

21 pages including 3 annexes which form an integral part
of this assessment

This European Technical Assessment is
issued in accordance with Regulation (EU)
No 305/2011, on the basis of

ETAG 001 Part 5: "Bonded anchors", April 2013,
used as EAD according to Article 66 Paragraph 3 of
Regulation (EU) No 305/2011.

This version replaces

ETA-13/0612 issued on 5 July 2016

The European Technical Assessment is issued by the Technical Assessment Body in its official language. Translations of this European Technical Assessment in other languages shall fully correspond to the original issued document and shall be identified as such.

Communication of this European Technical Assessment, including transmission by electronic means, shall be in full. However, partial reproduction may only be made with the written consent of the issuing Technical Assessment Body. Any partial reproduction shall be identified as such.

This European Technical Assessment may be withdrawn by the issuing Technical Assessment Body, in particular pursuant to information by the Commission in accordance with Article 25(3) of Regulation (EU) No 305/2011.

Specific Part

1 Technical description of the product

The DRIZORO S.A.U. MAXFIX-ER Injection Adhesive is a bonded anchor consisting of a cartridge with injection mortar ResEP-16 and a steel element. The steel elements are either

- Threaded rods in the range of M 12 to M 27 or
- Reinforcing bar in the range of ϕ 12 to ϕ 25 mm

The steel element is placed into a drilled hole filled with injection mortar and is anchored via the bond between metal part, injection mortar and concrete.

The product description is given in Annex A.

2 Specification of the intended use in accordance with the applicable European Assessment Document

The performances given in Section 3 are only valid if the anchor is used in compliance with the specifications and conditions given in Annex B.

The verifications and assessment methods on which this European Technical Assessment is based lead to the assumption of a working life of the anchor of at least 50 years. The indications given on the working life cannot be interpreted as a guarantee given by the producer, but are to be regarded only as a means for choosing the right products in relation to the expected economically reasonable working life of the works.

3 Performance of the product and references to the methods used for its assessment

3.1 Mechanical resistance and stability (BWR 1)

Essential characteristic	Performance
Characteristic resistance tension and shear loads	See Annex C 1 to C 4
Displacements under tension and shear loads	See Annex C 5 to C 6

3.2 Safety in case of fire (BWR 2)

Essential characteristic	Performance
Reaction to fire	Anchorage satisfy requirements for Class A1
Resistance to fire	No performance assessed

3.3 Hygiene, health and the environment (BWR 3)

Regarding dangerous substances there may be requirements (e.g. transposed European legislation and national laws, regulations and administrative provisions) applicable to the products falling within the scope of this European Technical Assessment. In order to meet the provisions of Regulation (EU) No 305/2011, these requirements need also to be complied with, when and where they apply.

3.4 Safety in use (BWR 4)

The essential characteristics regarding Safety in use are included under the Basic Works Requirement Mechanical resistance and stability.

English translation prepared by DIBt

4 Assessment and verification of constancy of performance (AVCP) system applied, with reference to its legal base

In accordance with guideline for European technical approval ETAG 001, April 2013 used as European Assessment Document (EAD) according to Article 66 Paragraph 3 of Regulation (EU) No 305/2011 the applicable European legal act is: [96/582/EC].

The system to be applied is: 1

5 Technical details necessary for the implementation of the AVCP system, as provided for in the applicable European Assessment Document

Technical details necessary for the implementation of the AVCP system are laid down in the control plan deposited with Deutsches Institut für Bautechnik.

Issued in Berlin on 6 October 2017 by Deutsches Institut für Bautechnik

BD Dipl.-Ing. Andreas Kummerow
Head of Department

Beglaubigt:
Baderschneider

MAXFIX-ER Epoxy Adhesive

MAXFIX-ER Injection mortar cartridges:
250 ml, 400 ml, 600 ml, 650 ml, 1500 ml and 1656 ml



Imprints:
Commercial name,
Manufacturer identification,
Installation instructions,
Shelf-life, Expiration date,
Batch-no., Hazard codes

Illustration: 650 ml Injection mortar cartridge (side-by-side)

Mixing nozzle: MN2



Mixing nozzle: MN2M



Extension tubes:

Flexible plastic hose: $\varnothing 8,0 - \varnothing 8,5$ mm



Rigid plastic tube: MNE



Threaded rod M12, M16, M20, M24 or M27

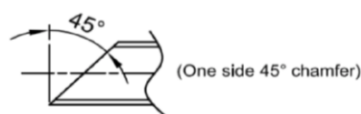
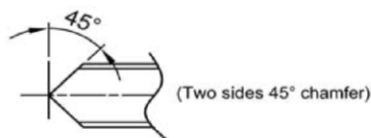
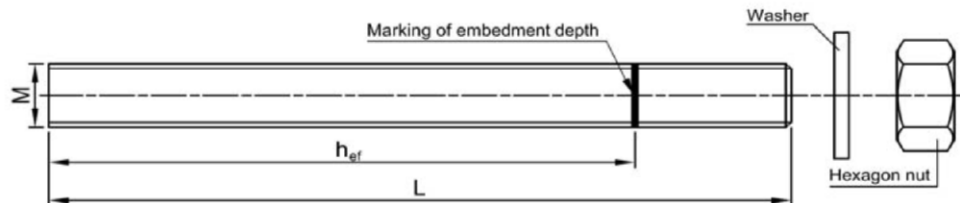

Reinforcing bar $\varnothing 12, \varnothing 14, \varnothing 16, \varnothing 20$ or $\varnothing 25$

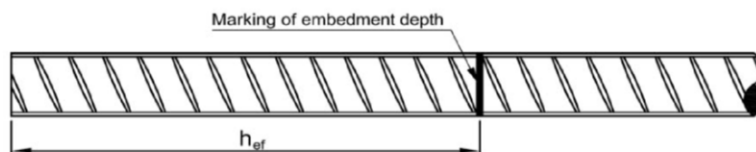

DRIZORO S.A.U. MAXFIX-ER Injection Adhesive

Product description
Injection mortar / Components / Anchoring parts

Annex A1

MAXFIX-ER Epoxy Adhesive

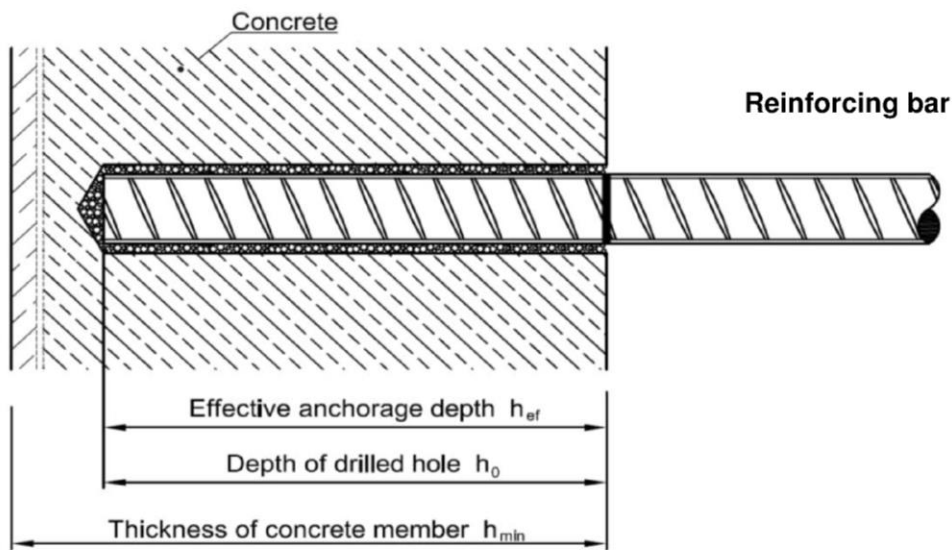
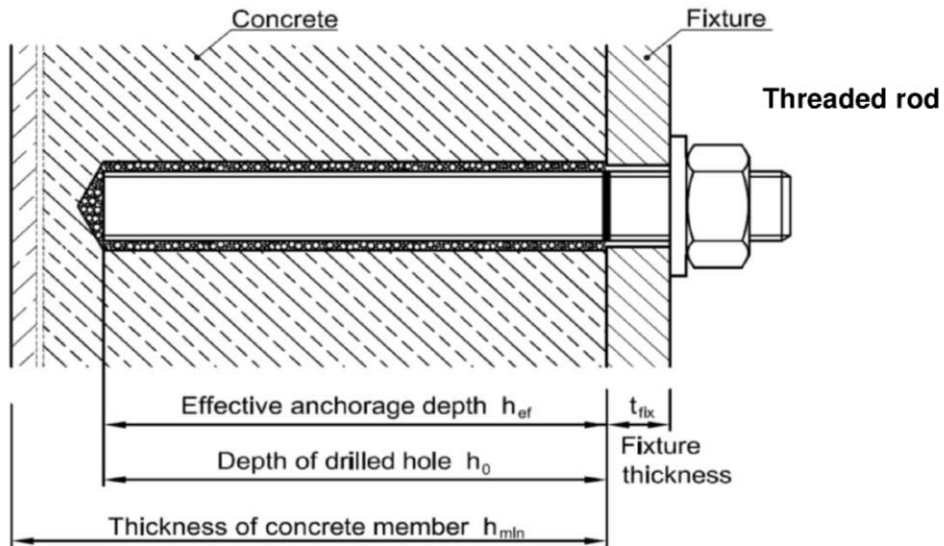

DRIZORO S.A.U. MAXFIX-ER Injection Adhesive

Product description
Installation

Annex A2

MAXFIX-ER Epoxy Adhesive

Table A1: Threaded rods

Designation	Material
Steel, zinc plated $\geq 5\mu\text{m}$ according EN ISO 4042, (A2), passivated Steel, hot-dip galvanised $> 40\mu\text{m}$ according EN ISO 10684	
Threaded rod	Carbon steel: Property class 5.8 and 8.8 acc. EN ISO 898-1:2013; A5 $\geq 8\%$ ductile
Washer	Steel: DIN 125-1:1990-03 (EN ISO 7089:2000), DIN 440:1990-05 (EN ISO 7094:2000), DIN 9021:1990-03 (EN ISO 7093-1:2000)
Hexagon nut	Steel: DIN 934:1987-10 (EN ISO 4032:2012), property class 8 acc. EN ISO 898-2:2012
Stainless steel	
Threaded rod	Stainless steel: 1.4362; 1.4401; 1.4404; 1.4439; 1.4571; 1.4578 acc. EN 10088-1:2014 $\leq M24$: Property class 70, EN ISO 3506-1:2009; A5 $\geq 8\%$ ductile $> M24$: Property class 50, EN ISO 3506-1:2009; A5 $\geq 8\%$ ductile
Washer	DIN 125-1:1990-03 (EN ISO 7089:2000), DIN 440:1990-05 (EN ISO 7094:2000), DIN 9021:1990-03 (EN ISO 7093-1:2000) Stainless steel: 1.4362; 1.4401; 1.4404; 1.4439; 1.4571; 1.4578 acc. EN 10088-1:2014
Hexagon nut	DIN 934:1987-10 (EN ISO 4032:2012), $\leq M24$: Property class 70, EN ISO 3506-2:2009 $> M24$: Property class 50 or 70, EN ISO 3506-2:2009 Stainless steel: 1.4362; 1.4401; 1.4404; 1.4439; 1.4571; 1.4578 acc. EN 10088-1:2014
Stainless steel - High corrosion resistance steel	
Threaded rod	Stainless steel: 1.4529; 1.4565 acc. EN 10088-1:2014 $\leq M24$: Property class 70, EN ISO 3506-2:2009 ; A5 $\geq 8\%$ ductile $> M24$: Property class 50, EN ISO 3506-2:2009 ; A5 $\geq 8\%$ ductile
Washer	DIN 125-1:1990-03 (EN ISO 7089:2000), DIN 440:1990-05 (EN ISO 7094:2000), DIN 9021:1990-03 (EN ISO 7093-1:2000) Stainless steel: 1.4529; 1.4565 acc. EN 10088-1:2014
Hexagon nut	DIN 934:1987-10 (EN ISO 4032:2012) $\leq M24$: Property class 70, EN ISO 3506-2:2009 $> M24$: Property class 50 or 70, EN ISO 3506-2:2009 Stainless steel: 1.4529; 1.4565 acc. EN 10088-1:2014
Commercial threaded rods with:	
Inspection certificate 3.1 according to EN 10204:2004	
Marking of embedment depth (This may be done by the manufacturer of the rod or by the worker on job site)	

DRIZORO S.A.U. MAXFIX-ER Injection Adhesive

Product description
Materials - Threaded rod

Annex A3

MAXFIX-ER Epoxy Adhesive

Table A2: Reinforcing bar

Designation	Material
Rebar according EN 1992-1-1:2004 + AC:2010, Annex C	Bars and de-coiled rods class B or C f_{yk} and k according to NDP or NCL of EN 1992-1-1/NA:2013 $f_{uk} = f_{tk} = k \cdot f_{yk}$

DRIZORO S.A.U. MAXFIX-ER Injection Adhesive

Product description
Materials - Reinforcement bar

Annex A4

Specification of intended use

Anchorage subject to:

- Static or quasi-static action
- Cracked concrete
- Non-cracked concrete

Base materials:

- Reinforced and unreinforced normal weight concrete according to EN 206-1: 2000
- Strength classes C20/25 to C50/60 according to EN 206-1: 2000

Temperature Range:

- **Installation:** $\geq 10^{\circ}\text{C}$
- **Use conditions:**
 - Temperatur Range I: -40°C to $+43^{\circ}\text{C}$ (max. long term temperature $+24^{\circ}\text{C}$ and max. short term temperature $+43^{\circ}\text{C}$)
 - Temperatur Range II: -40°C to $+65^{\circ}\text{C}$ (max. long term temperature $+43^{\circ}\text{C}$ and max. short term temperature $+65^{\circ}\text{C}$)

Use conditions (Environmental conditions)

- Structures subject to dry internal conditions (zinc coated steel, stainless steel or high corrosion resistant steel).
- Structures subject to external atmospheric exposure (including industrial and marine environment) and to permanent damp internal condition, if no particular aggressive conditions exist (stainless steel or high corrosion resistant steel).
- Structures subject to external atmospheric exposure and to permanently damp internal conditions, if other particular aggressive conditions exist (high corrosion resistant steel).

Note: Particular aggressive conditions are e.g. permanent, alternating immersion in seawater or the splash zone of seawater, chloride atmosphere of indoor swimming pools or atmosphere with extreme chemical pollution (e.g. in desulphurization plants or road tunnels where de-icing materials are used).

Design:

- Anchorages are to be designed under the responsibility of an engineer experienced in anchorages and concrete work.
- Verifiable calculation notes and drawings prepared are taking account of the loads to be anchored. The position of the anchor is indicated on the designed drawings (e.g. position of the anchor relative to reinforcement or to supports).
- Anchorages under static or quasi-static actions are designed in accordance with:
 - EOTA Technical Report TR 029 "Design of Bonded Anchors"; Edition September 2010
 - CEN/TS 1992-4:2009, "Design of Fastenings for use in concrete" part 4-1 and part 4-5,

Installation

- Use categorie: Dry or wet concrete (must not be installed in flooded holes).
- Anchor installation carried out by appropriately qualified personnel and under the supervision of the person responsible for technical matters of the site.
- Drilling by hammer-drilling.
- Overhead installation is allowed.

DRIZORO S.A.U. MAXFIX-ER Injection Adhesive

**Intended use
Specifications**

Annex B1

Table B1: Installation data for threaded rods

MAXFIX-ER Epoxy Adhesive			Threaded rod				
			M12	M16	M20	M24	M27
Nom. threaded rod diameter	d	[mm]	12	16	20	24	27
Drill hole diameter	d _o	[mm]	14	18	24	28	30
Effective anchorage depth	h _{ef, min}	[mm]	70	80	90	100	110
	h _{ef, max}		240	320	400	480	540
Diameter of clearance hole in the fixture	d _f ≤	[mm]	14	18	22	26	30
Installation torque	T _{inst, max}	[Nm]	40	60	80	100	120
Minimum thickness of concrete member	h _{min}	[mm]	h _{ef} +30 mm ≥ 100 mm	h _{ef} + 2d ₀			
Minimum allowable spacing	s _{min}	[mm]	80	100	115	135	155
Minimum allowable edge distance	c _{min}	[mm]	45	60	70	80	90

Table B2: Installation data for reinforcing bar

MAXFIX-ER Epoxy Adhesive			Reinforcing bar				
			Ø12	Ø14	Ø16	Ø20	Ø25
Nom. rebar diameter	d	[mm]	12	14	16	20	25
Drill hole diameter	d _o	[mm]	16	18	20	25	32
Effective anchorage depth	h _{ef, min}	[mm]	70	75	80	90	100
	h _{ef, max}		240	280	320	400	500
Minimum thickness of concrete member	h _{min}	[mm]	h _{ef} +30 mm ≥ 100 mm	h _{ef} + 2d ₀			
Minimum allowable spacing	s _{min}	[mm]	80	90	100	115	135
Minimum allowable edge distance	c _{min}	[mm]	45	50	60	70	80

DRIZORO S.A.U. MAXFIX-ER Injection Adhesive

Intended use
Installation data

Annex B2

HOLE PREPARATION

1.

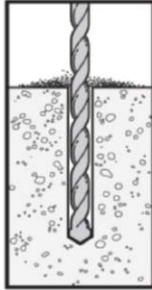

Drill hole to specified diameter and embedment depth.

2.

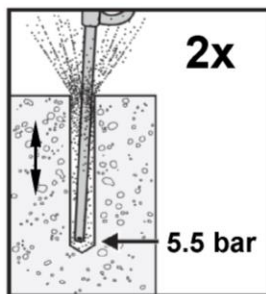

Blow dust from hole 2 times with oil-free compressed air (min. 5.5 bar) starting from the bottom of the hole.

3.

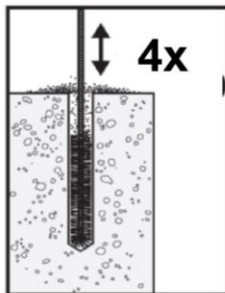

Brush 4 times with specified brush diameter (Annex B7).

4.

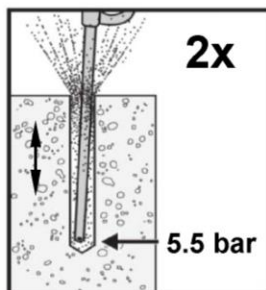

Blow 2 times with oil-free compressed air (min. 5.5 bar) and verify that the threaded rod and rebar can achieve the required embedment depth.

DRIZORO S.A.U. MAXFIX-ER Injection Adhesive

Intended use
Installation instructions

Annex B3

CARTRIDGE PREPARATION AND HOLE FILLING

1. Check cartridge expiration date. **Do not use expired product.** Product is usable until end of printed expiration month. Open cartridge per package instructions.

2.

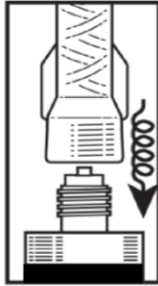

Attach proper mixing nozzle supplied by the manufacturer to the cartridge. Do not modify nozzle.

3.

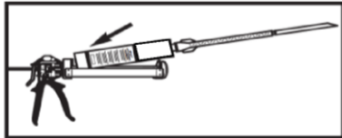

Insert cartridge into the appropriate dispensing tool.

4.

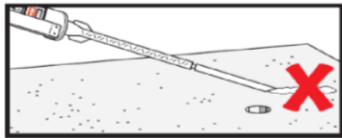

Dispense adhesive to the side until properly mixed, min. 3 strokes (uniform teal color). Discard initial adhesive!

5.

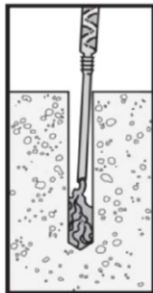

Fill hole approximately 2/3 full, starting from bottom or back of the cleaned drilled hole. Withdraw the nozzle slowly to avoid creating air pockets.

For drilled holes deeper than 150 mm (when $d_0 \leq 16\text{mm}$) and drilled holes deeper than 250 mm (when $16 < d_0 \leq 30\text{ mm}$) an extension tube shall be used (Annex A1). Adhesive retaining caps shall be used in overhead and horizontal installations (Annex B6).

DRIZORO S.A.U. MAXFIX-ER Injection Adhesive

Intended use
Installation instructions

Annex B4

ANCHOR INSTALLATION (vertical downward anchorage)

1.

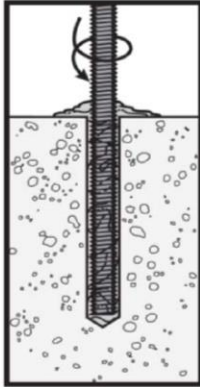

Insert clean, oil free anchor, turning slowly until the anchor contacts the bottom of the hole.
Setting control: Excess mortar flows out of the borehole.

2.

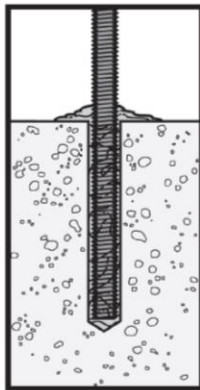

Do not disturb the anchor until fully cured. The curing time t_{cure} is given in table B3.

3.

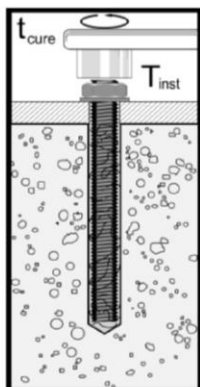

After required curing time t_{cure} anchor can be loaded. Apply the installation torque T_{inst} using calibrated torque-wrench.

DRIZORO S.A.U. MAXFIX-ER Injection Adhesive

Intended use
Installation instructions

Annex B5

ANCHOR INSTALLATION (horizontal and overhead anchorage)

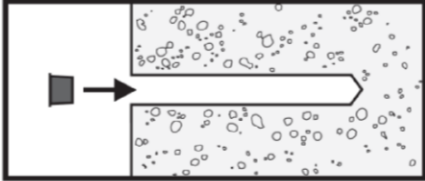
1. 

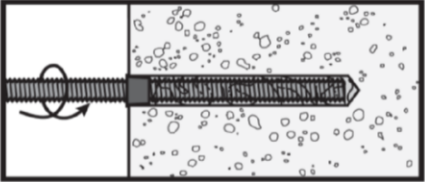
Install adhesive retaining cap.
2. 

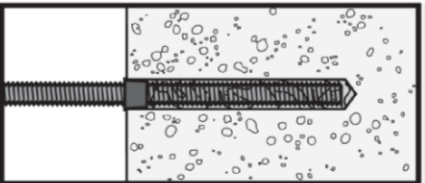
Insert clean, oil free anchor, turning slowly until the anchor contacts the bottom of the hole.
3. 

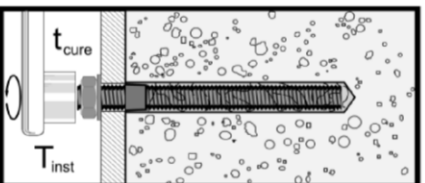
Do not disturb the anchor until fully cured. The curing time t_{cure} is given in table B3.
4. 

After required curing time t_{cure} anchor can be loaded. Apply the installation torque T_{inst} using calibrated torque-wrench.

Table B3: Maximum working and minimum curing time

Temperature in the anchorage base $T_{anchorage\ base}$	Working time t_{gel}	Curing time ¹⁾ t_{cure}
$T_{anchorage\ base} \geq 10^{\circ}C$	≤ 60 minutes	≥ 72 hours
$T_{anchorage\ base} \geq 21^{\circ}C$	≤ 45 minutes	≥ 24 hours
$T_{anchorage\ base} \geq 32^{\circ}C$	≤ 20 minutes	≥ 24 hours
$T_{anchorage\ base} \geq 43^{\circ}C$	≤ 12 minutes	≥ 24 hours

¹⁾ For installation in wet concrete, the curing times shall be doubled (installation in water-filled drilled holes is not allowed).

DRIZORO S.A.U. MAXFIX-ER Injection Adhesive

Intended use
Installation instructions

Annex B6

Table B4: Cleaning equipment

MAXFIX-ER Epoxy Adhesive		Threaded rod				
		M12	M16	M20	M24	M27
Drill bit	Diameter d_0 [mm]	14	18	24	28	30
Cleaning brush	Diameter d_b [mm]	19,1	19,1	25,4	31,8	31,8
	Length l_b [mm]	100	100	100	100	100
	Part number	ETB6	ETB6	ETB8	ETB10	ETB10

Table B5: Cleaning equipment

MAXFIX-ER Epoxy Adhesive		Reinforcing bar				
		Ø12	Ø14	Ø16	Ø20	Ø25
Drill bit	Diameter d_0 [mm]	16	18	20	25	32
Cleaning brush	Diameter d_b [mm]	19,1	19,1	25,4	31,8	41,3
	Length l_b [mm]	100	100	100	100	150
	Part number	ETB6	ETB6	ETB8	ETB10	ETB12

Cleaning brush (Nylon):



Compressed air cleaning tool



Air pressure: **min. 5,5 bar**
Orifice opening: **min. Ø3,5 mm**

DRIZORO S.A.U. MAXFIX-ER Injection Adhesive

Intended use
Installation equipment

Annex B7

**Table C1: Characteristic values of resistance to tension loads.
Design method TR 029 or CEN/TS 1992-4-5**

MAXFIX-ER Epoxy Adhesive			Threaded rod				
			M12	M16	M20	M24	M27
Steel failure							
Characteristic resistance, Steel grade 5.8	$N_{Rk,s}$	[kN]	42	79	123	177	230
Characteristic resistance, Steel grade 8.8	$N_{Rk,s}$	[kN]	67	126	196	282	367
Partial safety factor	$\gamma_{Ms}^{1)}$	[-]	1,5				
Stainless steel							
Characteristic resistance, Stainless steel A4 and HCR, property class 50 (>M24) and 70 (≤M24)	$N_{Rk,s}$	[kN]	59	110	172	247	230
Partial safety factor	$\gamma_{Ms}^{1)}$	[-]	1,87				2,86
Combined pull-out and concrete cone failure							
Nom. thread rod diameter	d	[mm]	12	16	20	24	27
Characteristic bond resistance in non-cracked concrete C20/25							
Temperature range I: 43°C / 24°C ²⁾	$\tau_{Rk,ucr}$	[N/mm ²]	17	10	10	9	7
Temperature range II: 65°C / 43°C ²⁾	$\tau_{Rk,ucr}$	[N/mm ²]	16	9,5	9,5	8,5	6,5
Factor according to CEN/TS 1992-4-5: 6.2.2.3	k_8	[-]	10,1				
Characteristic bond resistance in cracked concrete C20/25							
Temperature range I: 43°C / 24°C ²⁾	$\tau_{Rk,cr}$	[N/mm ²]	6	4,5	3	3	3
Temperature range II: 65°C / 43°C ²⁾	$\tau_{Rk,cr}$	[N/mm ²]	5,5	4,5	3	3	3
Factor according to CEN/TS 1992-4-5: 6.2.2.3	k_8	[-]	7,2				
Increasing factor for $\tau_{Rk,p}$ in non-cracked and cracked concrete	Ψ_c	C30/37	1,0				
		C40/50	1,0				
		C50/60	1,0				
Installation safety factor	$\gamma_2 = \gamma_{inst}$	[-]	1,4				
Concrete cone failure							
Factor according to CEN/TS 1992-4-5: 6.2.3.1	k_{cr}	[-]	7,2				
Factor according to CEN/TS 1992-4-5: 6.2.3.1	k_{ucr}	[-]	10,1				
Edge distance	$c_{cr,N}$	[mm]	1,5x h_{ef}				
Center spacing	$s_{cr,N}$	[mm]	3x h_{ef}				
Installation safety factor	$\gamma_2 = \gamma_{inst}$	[-]	1,4				
Splitting failure							
Edge distance (splitting)	$c_{cr,sp}^{3)4)}$	[mm]	$c_{cr,sp} = h_{ef} * \left(\frac{\tau_{k,ucr}}{8}\right)^{0,4} * \left(3,1 - 0,7 \frac{h}{h_{ef}}\right)$				
Center spacing (splitting)	$s_{cr,sp}$	[mm]	2x $c_{cr,sp}$				
Installation safety factor	$\gamma_2 = \gamma_{inst}$	[-]	1,4				

- 1) In absence of other national regulations
 2) Maximum short and long term temperatures
 3) Ratio value $[h/h_{ef}] \leq 2,4$

$$4) \tau_{k,ucr} \leq \frac{k_{ucr} * \sqrt{h_{ef} * f_{ck}}}{\pi * d}$$

DRIZORO S.A.U. MAXFIX-ER Injection Adhesive

Performances

Characteristic values of resistance to tension loads - Threaded rods
 Design method: EOTA TR 029:09/2010 or CEN/TS 1992-4-5:2009

Annex C1

**Table C2: Characteristic values of resistance to shear loads.
Design method TR 029 or CEN/TS 1992-4-5**

MAXFIX-ER Epoxy Adhesive			Threaded rod				
			M12	M16	M20	M24	M27
Steel failure without lever arm³⁾							
Characteristic shear resistance, Steel grade 5.8	$V_{Rk,s}$	[kN]	21	39	61	88	115
Characteristic shear resistance, Steel grade 8.8	$V_{Rk,s}$	[kN]	34	63	98	141	184
Partial safety factor	$\gamma_{Ms}^{1)}$	[-]	1,25				
Characteristic shear resistance, Stainless steel A4 and HCR, property class 50 (>M24) and 70 (\leq M24)	$V_{Rk,s}$	[kN]	30	55	86	124	115
Partial safety factor	$\gamma_{Ms}^{1)}$	[-]	1,56				
Steel failure with lever arm³⁾							
Characteristic bending moment, Steel grade 5.8	$M_{Rk,s}^0$	[Nm]	66	166	325	561	832
Characteristic bending moment, Steel grade 8.8	$M_{Rk,s}^0$	[Nm]	105	266	519	898	1332
Partial safety factor	$\gamma_{Ms}^{1)}$	[-]	1,25				
Characteristic bending moment, Stainless steel A4 and HCR, property class 50 (>M24) and 70 (\leq M24)	$M_{Rk,s}^0$	[Nm]	92	233	454	786	832
Partial safety factor	$\gamma_{Ms}^{1)}$	[-]	1,56				
Concrete pry-out failure							
Factor in equation (5.7) of TR 029 or in equation (27) to CEN/TS 1992-4-5	k / k_3	[-]	2				
Installation safety factor	$\gamma_2 = \gamma_{inst}$	[-]	1,0				
Concrete edge failure							
Effective anchor length	l_f	[-]	$h_{ef}^{2)}$				
Anchor diameter	$d = d_{nom}$	[-]	12	16	20	24	27
Installation safety factor	$\gamma_2 = \gamma_{inst}$	[-]	1,0				

¹⁾ In absence of other national regulations

²⁾ CEN/TS 1992-4-5: $h_{ef} \leq 8 d_{nom}$

³⁾ Ductility factor according to CEN/TS 1992-4-5: 6.3.2.1: $k_2 = 1,0$

DRIZORO S.A.U. MAXFIX-ER Injection Adhesive

Performances

Characteristic values of resistance to shear loads - Threaded rod
Design method: **EOTA TR 029:09/2010** or **CEN/TS 1992-4-5:2009**

Annex C2

**Table C3: Characteristic values of resistance to tension loads.
Design method TR 029 or CEN/TS 1992-4-5**

MAXFIX-ER Epoxy Adhesive			Reinforcing bar				
			Ø12	Ø14	Ø16	Ø20	Ø25
Steel failure							
Characteristic tension resistance B500B acc. DIN 488-2:2009-08 ⁴⁾	$N_{Rk,s}$	[kN]	62	85	111	173	270
Partial safety factor	γ_{Ms} ¹⁾	[-]	1,4				
Combined pull-out and concrete cone failure							
Nom. rebar diameter	d	[mm]	12	14	16	20	25
Characteristic bond resistance in non-cracked concrete C20/25							
Temperature range I: 43°C / 24°C ²⁾	$\tau_{Rk,ucr}$	[N/mm ²]	13,5	8	8	7	5,5
Temperature range II: 65°C / 43°C ²⁾	$\tau_{Rk,ucr}$	[N/mm ²]	12,5	7,5	7,5	6,5	5
Factor according to CEN/TS 1992-4-5: 6.2.2.3	k_g	[-]	10,1				
Characteristic bond resistance in cracked concrete C20/25							
Temperature range I: 43°C / 24°C ²⁾	$\tau_{Rk,cr}$	[N/mm ²]	5	3,5	2,5	2,5	2,5
Temperature range II: 65°C / 43°C ²⁾	$\tau_{Rk,cr}$	[N/mm ²]	4,5	3,5	2,5	2,5	2,5
Factor according to CEN/TS 1992-4-5: 6.2.2.3	k_g	[-]	7,2				
Increasing factor for $\tau_{Rk,p}$ in non-cracked and cracked concrete	Ψ_c	C30/37	1,0				
		C40/50	1,02				
		C50/60	1,04				
Installation safety factor	$\gamma_2 = \gamma_{inst}$	[-]	1,4				
Concrete cone failure							
Factor according to CEN/TS 1992-4-5: 6.2.3.1	k_{cr}	[-]	7,2				
Factor according to CEN/TS 1992-4-5: 6.2.3.1	k_{ucr}	[-]	10,1				
Edge distance (splitting)	$c_{cr,sp}$	[mm]	1,5x h_{ef}				
Center spacing (splitting)	$s_{cr,sp}$	[mm]	3x h_{ef}				
Installation safety factor	$\gamma_2 = \gamma_{inst}$	[-]	1,4				
Splitting failure							
Edge distance (splitting)	$c_{cr,sp}$ ³⁾⁵⁾	[mm]	$c_{cr,sp} = h_{ef} * \left(\frac{\tau_{k,ucr}}{8}\right)^{0,4} * \left(3,1 - 0,7 \frac{h}{h_{ef}}\right)$				
Center spacing (splitting)	$s_{cr,sp}$	[mm]	2x $c_{cr,sp}$				
Installation safety factor	$\gamma_2 = \gamma_{inst}$	[-]	1,4				

1) In absence of other national regulations

2) Maximum short and long term temperatures

3) Ratio value $[h/h_{ef}] \leq 2,4$

4) For reinforcement bars that do not comply with DIN 488: The characteristic tension resistance $N_{Rk,s}$ shall be determined acc. Technical Report TR 029, equation (5.5) or CEN/TS 1992-4-1, equation (B5).

$$5) \tau_{k,ucr} \leq \frac{k_{ucr} * \sqrt{h_{ef} * f_{ck}}}{\pi * d}$$

DRIZORO S.A.U. MAXFIX-ER Injection Adhesive

Performances

Characteristic values of resistance to tension loads - Reinforcing bar
Design method: EOTA TR 029:09/2010 or CEN/TS 1992-4-5:2009

Annex C3

**Table C4: Characteristic values of resistance to shear loads.
Design method TR 029 or CEN/TS 1992-4**

MAXFIX-ER Epoxy Adhesive			Reinforcing bar				
			Ø12	Ø14	Ø16	Ø20	Ø25
Steel failure without lever arm⁵⁾							
Characteristic resistance B500B acc. DIN 488-2:2009-08 ³⁾	$V_{Rk,s}$	[kN]	31	42	55	86	135
Partial safety factor	γ_{Ms} ¹⁾	[-]	1,5				
Steel failure with lever arm⁵⁾							
Characteristic bending moment B500B acc. DIN 488-2:2009-08 ⁴⁾	$M^0_{Rk,s}$	[Nm]	112	178	265	518	1012
Partial safety factor	γ_{Ms} ¹⁾	[-]	1,5				
Concrete pry-out failure							
Factor in equation (5.7) of TR 029 or in equation (27) to CEN/TS 1992-4-5	k / k_3	[-]	2				
Installation safety factor	$\gamma_2 = \gamma_{inst}$	[-]	1,0				
Concrete edge failure							
Effectiv anchor length	l_f	[-]	h_{ef} ²⁾				
Anchor diameter	$d = d_{nom}$	[-]	12	14	16	20	25
Installation safety factor	$\gamma_2 = \gamma_{inst}$	[-]	1,0				

1) In absence of other national regulations

2) CEN/TS 1992-4-5: $h_{ef} \leq 8 d_{nom}$

3) For reinforcing bars that do not comply with DIN 488: The characteristic resistance $V_{Rk,s}$ shall be determined acc. Technical report TR 029, equation (5.5) or CEN/TS 1992-4-1, equation (B8).

4) For reinforcing bars that do not comply with DIN 488: The characteristic bending moment $M^0_{Rk,s}$ shall be determined with: $M^0_{Rk,s} = 1,2 \times W_{el} \times f_{uk}$

5) Ductility factor according to CEN/TS 1992-4-5: 6.3.2.1: $k_2 = 1,0$

DRIZORO S.A.U. MAXFIX-ER Injection Adhesive

Performances

Characteristic values of resistance to shear loads - Reinforcing bar
Design method: EOTA TR 029:09/2010 or CEN/TS 1992-4-5:2009

Annex C4

Table C5: Displacements under tension loads ¹⁾

MAXFIX-ER Epoxy Adhesive			Threaded rod				
			M12	M16	M20	M24	M27
Non-cracked concrete							
Temperature range I: 43°C / 24°C ²⁾							
Factor for displacement	δ_{N0} -factor	[mm/(N/mm ²)]	0,020	0,030	0,010	0,010	0,030
	$\delta_{N\infty}$ -factor	[mm/(N/mm ²)]	0,024	0,040	0,040	0,044	0,064
Temperature range II: 65°C / 43°C ²⁾							
Factor for displacement	δ_{N0} -factor	[mm/(N/mm ²)]	0,020	0,030	0,010	0,012	0,031
	$\delta_{N\infty}$ -factor	[mm/(N/mm ²)]	0,025	0,042	0,042	0,047	0,070
Cracked concrete							
Temperature range I: 43°C / 24°C ²⁾							
Factor for displacement ¹⁾	δ_{N0} -factor	[mm/(N/mm ²)]	0,100	0,100	0,230	0,200	0,170
	$\delta_{N\infty}$ -factor	[mm/(N/mm ²)]	0,133	0,180	0,270	0,300	0,300
Temperature range II: 65°C / 43°C ²⁾							
Factor for displacement	δ_{N0} -factor	[mm/(N/mm ²)]	0,100	0,130	0,230	0,200	0,170
	$\delta_{N\infty}$ -factor	[mm/(N/mm ²)]	0,145	0,180	0,270	0,300	0,300

¹⁾ Calculation of the displacement:

$$\delta_{N0} = \delta_{N0}\text{-factor} \cdot \tau \quad \tau = \text{action bond stress for tension}$$

$$\delta_{N\infty} = \delta_{N\infty}\text{-factor} \cdot \tau$$

²⁾ Maximum short and long term temperatures

Table C6: Displacements under shear loads ³⁾

MAXFIX-ER Epoxy Adhesive			Threaded rod				
			M12	M16	M20	M24	M27
Factor for displacement	δ_{V0} -factor	[mm/kN]	0,022	0,015	0,012	0,005	0,005
	$\delta_{V\infty}$ -factor	[mm/kN]	0,033	0,022	0,018	0,010	0,010

³⁾ Calculation of the displacement:

$$\delta_{V0} = \delta_{V0}\text{-factor} \cdot V \quad V = \text{action shear load}$$

$$\delta_{V\infty} = \delta_{V\infty}\text{-factor} \cdot V$$

DRIZORO S.A.U. MAXFIX-ER Injection Adhesive

Performances
Displacements - Threaded rod

Annex C5

Table C7: Displacements under tension loads ¹⁾

MAXFIX-ER Epoxy Adhesive			Reinforcing bar				
			Ø12	Ø14	Ø16	Ø20	Ø25
Non-cracked concrete							
Temperature range I: 43°C / 24°C ²⁾							
Factor for displacement	δ_{N0} -factor	[mm/(N/mm ²)]	0,015	0,030	0,040	0,043	0,055
	$\delta_{N\infty}$ -factor	[mm/(N/mm ²)]	0,033	0,056	0,063	0,071	0,090
Temperature range II: 65°C / 43°C ²⁾							
Factor for displacement	δ_{N0} -factor	[mm/(N/mm ²)]	0,020	0,030	0,040	0,045	0,050
	$\delta_{N\infty}$ -factor	[mm/(N/mm ²)]	0,036	0,060	0,066	0,077	0,100
Cracked concrete							
Temperature range I: 43°C / 24°C ²⁾							
Factor for displacement	δ_{N0} -factor	[mm/(N/mm ²)]	0,100	0,170	0,280	0,240	0,200
	$\delta_{N\infty}$ -factor	[mm/(N/mm ²)]	0,160	0,220	0,320	0,440	0,440
Temperature range II: 65°C / 43°C ²⁾							
Factor for displacement	δ_{N0} -factor	[mm/(N/mm ²)]	0,110	0,170	0,280	0,240	0,200
	$\delta_{N\infty}$ -factor	[mm/(N/mm ²)]	0,178	0,228	0,320	0,440	0,440

¹⁾ Calculation of the displacement:

$$\delta_{N0} = \delta_{N0}\text{-factor} \cdot \tau \quad \tau = \text{action bond stress for tension}$$

$$\delta_{N\infty} = \delta_{N\infty}\text{-factor} \cdot \tau$$

²⁾

Maximum short and long term temperatures

Table C8: Displacements under shear loads

MAXFIX-ER Epoxy Adhesive			Reinforcing bar				
			Ø12	Ø14	Ø16	Ø20	Ø25
Factor for displacement ³⁾	δ_{V0}	[mm/kN]	0,010	0,010	0,013	0,015	0,015
	$\delta_{V\infty}$	[mm/kN]	0,013	0,015	0,019	0,023	0,023

³⁾ Calculation of the displacement:

$$\delta_{V0} = \delta_{V0}\text{-factor} \cdot V \quad V = \text{action shear load}$$

$$\delta_{V\infty} = \delta_{V\infty}\text{-factor} \cdot V$$

DRIZORO S.A.U. MAXFIX-ER Injection Adhesive

Performances
Displacements - Reinforcing bar

Annex C6