

Approval body for construction products  
and types of construction

Bautechnisches Prüfamt

An institution established by the Federal and  
Laender Governments



## European Technical Assessment

**ETA-16/0043**  
**of 30 March 2017**

English translation prepared by DIBt - Original version in German language

### General Part

Technical Assessment Body issuing the  
European Technical Assessment:

Deutsches Institut für Bautechnik

Trade name of the construction product

Würth Concrete Screw W-BS/S, W-BS/A4, W-BS/HCR

Product family  
to which the construction product belongs

Concrete Screw of sizes 6, 8, 10, 12 and 14 mm for use in  
concrete

Manufacturer

Adolf Würth GmbH & Co. KG  
Reinhold-Würth-Straße 12-17  
74653 Künzelsau  
DEUTSCHLAND

Manufacturing plant

Herstellwerk W9

This European Technical Assessment  
contains

16 pages including 3 annexes which form an integral part  
of this assessment

This European Technical Assessment is  
issued in accordance with Regulation (EU)  
No 305/2011, on the basis of

European Assessment Document (EAD)  
330232-00-0601 and 330011-00-0601

This version replaces

ETA-16/0043 issued on 4 April 2016

**European Technical Assessment  
ETA-16/0043**

**Page 2 of 16 | 30 March 2017**

English translation prepared by DIBt

The European Technical Assessment is issued by the Technical Assessment Body in its official language. Translations of this European Technical Assessment in other languages shall fully correspond to the original issued document and shall be identified as such.

Communication of this European Technical Assessment, including transmission by electronic means, shall be in full. However, partial reproduction may only be made with the written consent of the issuing Technical Assessment Body. Any partial reproduction shall be identified as such.

This European Technical Assessment may be withdrawn by the issuing Technical Assessment Body, in particular pursuant to information by the Commission in accordance with Article 25(3) of Regulation (EU) No 305/2011.

English translation prepared by DIBt

**Specific part**

**1 Technical description of the product**

The Würth Concrete Screw W-BS an anchor in size 6, 8, 10, 12 and 14 mm made of galvanised steel respectively steel with zinc flake coating, made of stainless or high corrosion resistant steel. The anchor is screwed into a predrilled cylindrical drill hole. The special thread of the anchor cuts an internal thread into the member while setting. The anchorage is characterised by mechanical interlock in the special thread.

Product and product description is given in Annex A.

**2 Specification of the intended use in accordance with the applicable European Assessment Document**

The performances given in Section 3 are only valid if the anchor is used in compliance with the specifications and conditions given in Annex B.

The verifications and assessment methods on which this European Technical Assessment is based lead to the assumption of a working life of the anchor of at least 50 years. The indications given on the working life cannot be interpreted as a guarantee given by the producer, but are to be regarded only as a means for choosing the right products in relation to the expected economically reasonable working life of the works.

**3 Performance of the product and references to the methods used for its assessment**

**3.1 Mechanical resistance and stability (BWR 1)**

Essential characteristic	Performance
Product performance for static and quasi static action	See Annex C 1 and C 2
Product performance for seismic category C1	See Annex C 4
Displacements under tension and shear loads	See Annex C 3

**3.2 Safety in case of fire (BWR 2)**

Essential characteristic	Performance
Reaction to fire	Anchorage satisfy requirements for Class A1
Resistance to fire	See Annex C 5

**3.3 Safety in use (BWR 4)**

The essential characteristics regarding Safety in use are included under the Basic Works Requirement Mechanical resistance and stability.

**4 Assessment and verification of constancy of performance (AVCP) system applied, with reference to its legal base**

In accordance with European Assessment Documents EAD No. 330232-00-0601 and EAD No. 330011-00-0601, the applicable European legal act is: [96/582/EC].

The system to be applied is: 1

English translation prepared by DIBt

**5 Technical details necessary for the implementation of the AVCP system, as provided for in the applicable EAD**

Technical details necessary for the implementation of the AVCP system are laid down in the control plan deposited with Deutsches Institut für Bautechnik.

Issued in Berlin on 30 March 2017 by Deutsches Institut für Bautechnik

Uwe Bender  
Head of Department

*beglaubigt:*  
Tempel

**Product and installed condition**

**Concrete Screw W-BS**



steel, zinc plated



stainless steel A4 and HCR

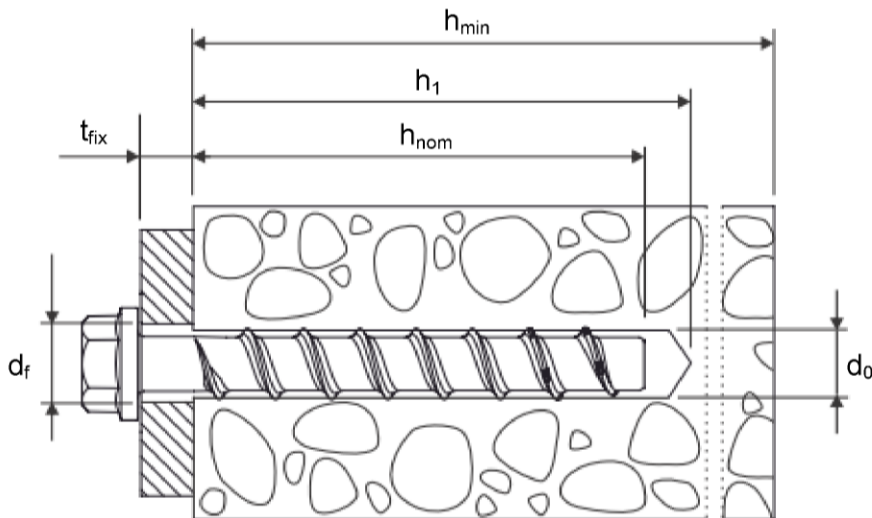

- $d_0$  = nominal drill bit diameter
- $h_{nom}$  = nominal anchorage depth
- $h_1$  = depth of the drill hole
- $h_{min}$  = minimum thickness of member
- $t_{fix}$  = thickness of fixture
- $d_f$  = diameter of clearance hole in the fixture

**Würth Concrete Screw W-BS/S, W-BS/A4, W-BS/HCR**























**Product description**

Installed condition

**Annex A 1**

**Table A1: materials and variants**

part	name	Material			
1, 2, 3, 4, 5, 6, 7, 8, 9, 10, 11	Concrete screw	W-BS/S	Steel EN 10263-4 galvanized acc. to EN ISO 4042 or zinc flake coating acc. to EN ISO 10683 ( $\geq 5\mu\text{m}$ )		
W-BS/A4		1.4401, 1.4404, 1.4571, 1.4578			
W-BS/HCR		1.4529			
				W-BS/S, W-BS/A4, W-BS/HCR	
		nominal characteristic steel yield strength	$f_{yk}$	[N/mm <sup>2</sup> ]	560
		nominal characteristic steel ultimate strength	$f_{uk}$	[N/mm <sup>2</sup> ]	700
		elongation at rupture	$A_5$	[%]	$\leq 8$

		1)	Anchor version with connection thread and hexagon socket e.g. W-BS 8x105 M10 SW5
		2)	Anchor version with connection thread and hexagon drive e.g. W-BS 8x105 M10 SW7
		3)	Anchor version with washer, hexagon head e.g. W-BS 8x80 SW13
		4)	Anchor version with washer and hexagon head and TORX e.g. W-BS 8x80 SW13 TX40
		5)	Anchor version with washer, hexagon head e.g. W-BS 8x80 SW13
		6)	Anchor version with countersunk head e.g. W-BS 8x80 TX40
		7)	Anchor version with pan head e.g. W-BS 8x80 TX40
		8)	Anchor version with large pan head e.g. W-BS 8x80 TX40
		9)	Anchor version with countersunk head and connection thread e.g. W-BS 6x55 M8
		10)	Anchor version with hexagon drive and connection thread e.g. W-BS 6x55 M8 SW10
		11)	Anchor version with internal thread and hexagon drive e.g. W-BS 6x55 IM M8/10

**Würth Concrete Screw W-BS/S, W-BS/A4, W-BS/HCR**

**Product descriptions**  
Materials und versions

**Annex A 2**

**Table A2: dimensions and markings**

Anchor size W-BS			6		8			10		
Nominal embedment depth $h_{nom}$ [mm]			$h_{nom1}$	$h_{nom2}$	$h_{nom1}$	$h_{nom2}$	$h_{nom3}$	$h_{nom1}$	$h_{nom2}$	$h_{nom3}$
			40	55	45	55	65	55	75	85
Length of the anchor	$L \leq$	[mm]	500							
Diameter of shaft	$d_k$	[mm]	5.1		7.1			9.1		
Diameter of thread	$d_s$	[mm]	7.5		10.6			12.6		
Anchor size W-BS			12			14				
Nominal embedment depth $h_{nom}$ [mm]			$h_{nom1}$	$h_{nom2}$	$h_{nom3}$	$h_{nom1}$	$h_{nom2}$	$h_{nom3}$		
			65	85	100	75	100	115		
Length of the anchor	$L \leq$	[mm]	500							
Diameter of shaft	$d_k$	[mm]	11.1			13.1				
Diameter of thread	$d_s$	[mm]	14.6			16.6				



**Marking**

W-BS/S  
Description:  
Anchor size:  
Length of the anchor:

W-BS  
e.g. 6  
e.g. 60



W-BS/A4  
Description:  
Anchor size:  
Length of the anchor:  
Material:

TSM or W-BS  
e.g. 6  
e.g. 60  
A4



W-BS/HCR  
Description:  
Anchor size:  
Length of the anchor:  
Material:

TSM or W-BS  
e.g. 6  
e.g. 60  
HCR

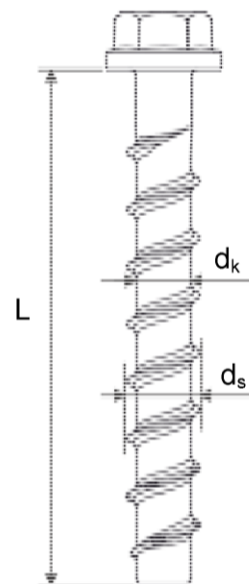

**Würth Concrete Screw W-BS/S, W-BS/A4, W-BS/HCR**

**Product descriptions**

Dimensions and markings

**Annex A 3**

## Intended use

### Anchorage subject to:

- static and quasi-static loads, all sizes and all embedment depth
- used for anchorages with requirements related to resistance of fire, all sizes and all embedment depth,
- used for anchorages with seismic actions category C1, sizes 8-14 for maximum embedment depth  $h_{nom3}$ .

### Base materials:

- reinforced and unreinforced concrete according to EN 206-1:2000,
- strength classes C20/25 to C50/60 according to EN 206-1:2000,
- cracked and uncracked concrete.

### Use conditions (Environmental conditions):

- The anchor may only be used in dry internal conditions: All screw types,
- Structural subject to external atmospheric exposure (including industrial and marine environment) and to permanently damp internal condition no particular aggressive conditions exists: screw types made of stainless steel with marking A4,
- Structural subject to external atmospheric exposure (including industrial and marine environment) and to permanently damp internal condition if particular aggressive conditions exists: screw types made of stainless steel with marking HCR.

Note: Such particular aggressive conditions are e.g. permanent, alternating immersion in seawater or the splash zone of seawater, chloride atmosphere of indoor swimming pools or atmosphere with chemical pollution (e.g. in desulphurization plants or road tunnels where de-icing materials are used)

### Design:

- Anchorages are designed under the responsibility of an engineer experienced in anchorages and concrete work,
- Verifiable calculation notes and drawings are prepared taking account of the loads to be anchored. The position of the anchor is indicated on the design drawings,
- Anchorages under static or quasi-static actions, under seismic actions and under fire exposure are designed in accordance with EN 1992-4:2017,
- The design of anchorages under shear load according to EN 1992-4:2017, Section 6.2.2 applies for all specified diameters  $d_f$  of clearance hole in the fixture in Annex B 2, Table B1.

### Installation:

- Hammer drilling only.
- Fastener installation in accordance with the manufacturer's specifications using the appropriate tools carried out by appropriately qualified personnel.
- After installation further turning of the anchor is not possible. The head of the anchor is supported on the fixture and is not damaged.
- The drill hole can be used without or with injection mortar WIT-BS.
- Adjustability according to Annex B 4: sizes 8-14, all anchorage depths.

Würth Concrete Screw W-BS/S, W-BS/A4, W-BS/HCR

Intended use  
Specifications

Annex B 1



**Table B1: Installation parameters**

Anchor size W-BS			6		8			10			
Nominal embedment depth $h_{nom}$ [mm]			$h_{nom1}$	$h_{nom2}$	$h_{nom1}$	$h_{nom2}$	$h_{nom3}$	$h_{nom1}$	$h_{nom2}$	$h_{nom3}$	
			40	55	45	55	65	55	75	85	
Nominal drill bit diameter	$d_0$	[mm]	6		8			10			
Cutting diameter of drill bit	$d_{cut} \leq$	[mm]	6,40		8,45			10,45			
Depth of drill hole	$h_1 \geq$	[mm]	45	60	55	65	75	65	85	95	
Diameter of clearing hole in the fixture	$d_f \leq$	[mm]	8		12			14			
Installation torque for version with connection thread	$T_{inst}$	[Nm]	10		20			40			
Impact screw driver		[Nm]	Max. torque according to manufacturer's instructions								
			160		300			400			
Anchor size W-BS			12			14					
Nominal embedment depth $h_{nom}$ [mm]			$h_{nom1}$	$h_{nom2}$	$h_{nom3}$	$h_{nom1}$	$h_{nom2}$	$h_{nom3}$			
			65	85	100	75	100	115			
Nominal drill bit diameter	$d_0$	[mm]	12			14					
Cutting diameter of drill bit	$d_{cut} \leq$	[mm]	12,50			14,50					
Depth of drill hole	$h_1 \geq$	[mm]	75	95	110	85	110	125			
Diameter of clearing hole in the fixture	$d_f \leq$	[mm]	16			18					
Installation torque for version with connection thread metrical	$T_{inst}$	[Nm]	60			80					
Impact screw driver			Max. torque according to manufacturer's instructions								
			650			650					

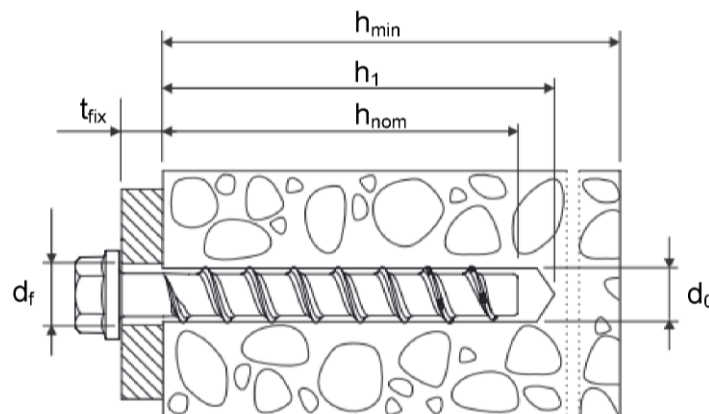

**Würth Concrete Screw W-BS/S, W-BS/A4, W-BS/HCR**

**Intended use**

Installation parameters

**Annex B 2**

**Table B2: Minimum thickness of member, minimum edge distance and minimum spacing**

Anchor size W-BS			6		8			10		
Nominal embedment depth $h_{nom}$ [mm]			$h_{nom1}$	$h_{nom2}$	$h_{nom1}$	$h_{nom2}$	$h_{nom3}$	$h_{nom1}$	$h_{nom2}$	$h_{nom3}$
			40	55	45	55	65	55	75	85
Minimum thickness of member	$h_{min}$	[mm]	100		100		120	100	130	130
Minimum edge distance	$c_{min}$	[mm]	40		40	50		50		
Minimum spacing	$s_{min}$	[mm]	40		40	50		50		
Anchor size W-BS			12			14				
Nominal embedment depth $h_{nom}$ [mm]			$h_{nom1}$	$h_{nom2}$	$h_{nom3}$	$h_{nom1}$	$h_{nom2}$	$h_{nom3}$		
			65	85	100	75	100	115		
Minimum thickness of member	$h_{min}$	[mm]	120	130	150	130	150	170		
Minimum edge distance	$c_{min}$	[mm]	50		70	50	70			
Minimum spacing	$s_{min}$	[mm]	50		70	50	70			

**Installation instructions**

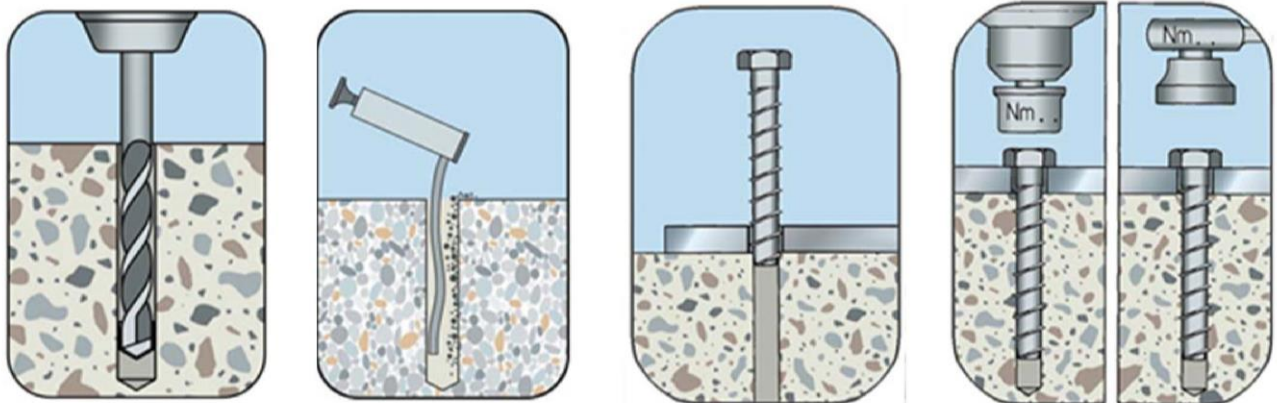

**Würth Concrete Screw W-BS/S, W-BS/A4, W-BS/HCR**

**Intended use**

Minimum thickness of member, minimum spacing, minimum edge distance and installation instructions

**Annex B 3**

### Installation instructions for adjustability

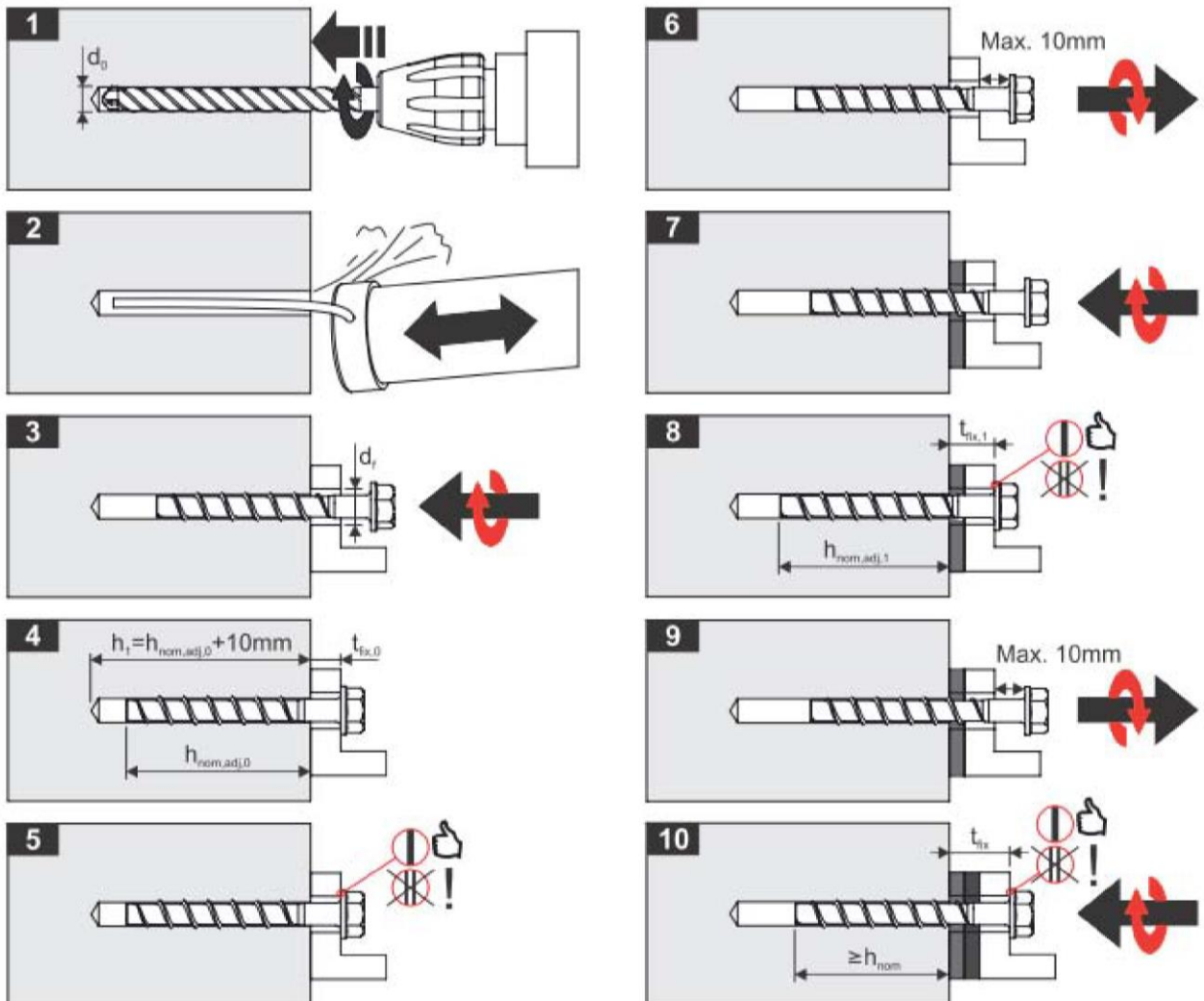

### Installation instructions

The anchor may be adjusted maximum two times while the anchor may turn back at most 10 mm.  
The total allowed thickness of shims added during the adjustment process is 10mm.  
The final embedment depth after adjustment process must be equal or larger than  $h_{nom}$ .

Würth Concrete Screw W-BS/S, W-BS/A4, W-BS/HCR

Intended use

Installation instruction for adjustability

Annex B 4

**Table C1: Characteristic values for design method A  
for W-BS 6, 8 and 10**

Anchor size W-BS			6		8			10			
Nominal embedment depth $h_{nom}$ [mm]			$h_{nom1}$	$h_{nom2}$	$h_{nom1}$	$h_{nom2}$	$h_{nom3}$	$h_{nom1}$	$h_{nom2}$	$h_{nom3}$	
			40	55	45	55	65	55	75	85	
<b>steel failure for tension- and shear load</b>											
characteristic load	$N_{RK,s}$	[kN]	14.0		27.0			45.0			
	$V_{RK,s}$	[kN]	7.0		13,5		17,0	22,5		34,0	
	$k_7$	[-]	0.8		0.8			0.8			
	$M^0_{RK,s}$	[Nm]	10.0		26.0			56.0			
partial safety factor	$\gamma_{Ms}$	[-]	1.5								
<b>pull-out failure</b>											
characteristic tension load in cracked concrete C20/25	$N_{RK,p}$	[kN]	2.0	4.0	5.0	9.0	12.0	9.0	Pull-out failure is not decisive		
characteristic tension load in uncracked concrete C20/25	$N_{RK,p}$	[kN]	4.0	9.0	7.5	12.0	16.0	12.0	20.0	26.0	
increasing factor for $N_{RK,p}$	$\psi_C$	C30/37	1.22								
		C40/50	1.41								
		C50/60	1.58								
<b>concrete cone and splitting failure</b>											
effective anchorage depth	$h_{ef}$	[mm]	31	44	35	43	52	43	60	68	
factor $k_1$	cracked	$k_{cr,N}$	7.7								
	uncracked	$k_{ucr,N}$	11.0								
concrete cone failure	spacing	$s_{cr,N}$	$3 \times h_{ef}$								
	edge distance	$c_{cr,N}$	$1.5 \times h_{ef}$								
splitting failure	spacing	$s_{cr,Sp}$	120	160	120	140	150	140	180	210	
	edge distance	$c_{cr,Sp}$	60	80	60	70	75	70	90	105	
installation safety factor	$\gamma_{inst}$	[-]	1.0								
<b>concrete pry out failure (pry-out)</b>											
factor	$k_8$	[-]	1.0						2.0		
<b>concrete edge failure</b>											
effective length of anchor	$l_f = h_{ef}$	[mm]	31	44	35	43	52	43	60	68	
outside diameter of anchor	$d_{nom}$	[mm]	6		8			10			

Würth Concrete Screw W-BS/S, W-BS/A4, W-BS/HCR

**Performances**

Characteristic values for W-BS 6, 8 and 10

**Annex C 1**

**Table C2: Characteristic values for design method A  
for W-BS 12 and 14**

Anchor size W-BS			12			14		
Nominal embedment depth $h_{nom}$ [mm]			$h_{nom1}$	$h_{nom2}$	$h_{nom3}$	$h_{nom1}$	$h_{nom2}$	$h_{nom3}$
			65	85	100	75	100	115
<b>steel failure for tension- and shear load</b>								
characteristic load	$N_{RK,s}$	[kN]	67.0			94.0		
	$V_{RK,s}$	[kN]	33,5	40,0		56.0		
	$k_7$	[-]	0.8			0.8		
	$M_{RK,s}^0$	[Nm]	113.0			185.0		
partial safety factor	$\gamma_{Ms}$	[-]	1.5					
<b>pull-out failure</b>								
characteristic tension load in cracked concrete C20/25	$N_{RK,p}$	[kN]	12.0	Pull-out failure is not decisive			Pull-out failure is not decisive	
characteristic tension load in uncracked concrete C20/25	$N_{RK,p}$	[kN]	16.0					
increasing factor for $N_{RK,p}$	$\psi_C$	C30/37	1.22					
		C40/50	1.41					
		C50/60	1.58					
<b>concrete cone and splitting failure</b>								
effective anchorage depth	$h_{ef}$	[mm]	50	67	80	58	79	92
factor $k_1$	cracked	$k_{cr,N}$	7.7					
	uncracked	$k_{ucr,N}$	11.0					
concrete cone failure	spacing	$s_{cr,N}$	$3 \times h_{ef}$					
	edge distance	$c_{cr,N}$	$1.5 \times h_{ef}$					
splitting failure	spacing	$s_{cr,Sp}$	150	210	240	180	240	280
	edge distance	$c_{cr,Sp}$	75	105	120	90	120	140
installation safety factor	$\gamma_{inst}$	[-]	1.0					
<b>concrete pry out failure (pry-out)</b>								
factor	$k_8$	[-]	1.0	2.0		1.0	2.0	
<b>concrete edge failure</b>								
effective length of anchor	$l_f = h_{ef}$	[mm]	50	67	80	58	79	92
outside diameter of anchor	$d_{nom}$	[mm]	12			14		

Würth Concrete Screw W-BS/S, W-BS/A4, W-BS/HCR

**Performances**

Characteristic values for W-BS 12 and 14

**Annex C 2**

**Table C3: Displacements under tension load for W-BS**

Anchor size W-BS				6		8			10		
Nominal embedment depth $h_{nom}$ [mm]				$h_{nom1}$	$h_{nom2}$	$h_{nom1}$	$h_{nom2}$	$h_{nom3}$	$h_{nom1}$	$h_{nom2}$	$h_{nom3}$
				40	55	45	55	65	55	75	85
cracked concrete	tension load	N	[kN]	0.95	1.9	2.4	4.3	5.7	4.3	7.9	9.6
	displacement	$\delta_{N0}$	[mm]	0.3	0.6	0.6	0.7	0.8	0.6	0.5	0.9
		$\delta_{\infty}$	[mm]	0.4	0.4	0.6	1.0	0.9	0.4	1.2	1.2
un- cracked concrete	tension load	N	[kN]	1.9	4.3	3.6	5.7	7.6	5.7	9.5	11.9
	displacement	$\delta_{N0}$	[mm]	0.4	0.6	0.7	0.9	0.5	0.7	1.1	1.0
		$\delta_{N\infty}$	[mm]	0.4	0.4	0.6	1.0	0.9	0.4	1.2	1.2

Anchor size W-BS				12			14		
Nominal embedment depth $h_{nom}$ [mm]				$h_{nom1}$	$h_{nom2}$	$h_{nom3}$	$h_{nom1}$	$h_{nom2}$	$h_{nom3}$
				65	85	100	75	100	115
cracked concrete	tension load	N	[kN]	5.7	9.4	12.3	7.6	12.0	15.1
	displacement	$\delta_{N0}$	[mm]	0.9	0.5	1.0	0.5	0.8	0.7
		$\delta_{\infty}$	[mm]	1.0	1.2	1.2	0.9	1.2	1.0
un- cracked concrete	tension load	N	[kN]	7.6	13.2	17.2	10.6	16.9	21.2
	displacement	$\delta_{N0}$	[mm]	1.0	1.1	1.2	0.9	1.2	0.8
		$\delta_{N\infty}$	[mm]	1.0	1.2	1.2	0.9	1.2	1.0

**Table C4 : Displacements under shear load for W-BS**

Anchor size W-BS				6		8			10		
Nominal embedment depth $h_{nom}$ [mm]				$h_{nom1}$	$h_{nom2}$	$h_{nom1}$	$h_{nom2}$	$h_{nom3}$	$h_{nom1}$	$h_{nom2}$	$h_{nom3}$
				40	55	45	55	65	55	75	85
shear load	V	[kN]		3.3		8.6			16.2		
displacement	$\delta_{V0}$	[mm]		1.55		2.7			2.7		
	$\delta_{V\infty}$	[mm]		3.10		4.1			4.3		

Anchor size W-BS				12			14		
Nominal embedment depth $h_{nom}$ [mm]				$h_{nom1}$	$h_{nom2}$	$h_{nom3}$	$h_{nom1}$	$h_{nom2}$	$h_{nom3}$
				65	85	100	75	100	115
shear load	N	[kN]		20.0			30.5		
displacement	$\delta_{V0}$	[mm]		4.0			3.1		
	$\delta_{V\infty}$	[mm]		6.0			4.7		

**Würth Concrete Screw W-BS/S, W-BS/A4, W-BS/HCR**

**Performances**

Displacements under tension and shear loads

**Annex C 3**

**Table C5: Characteristic values for seismic category C1**

Anchor size W-BS			8	10	12	14
Nominal embedment depth $h_{nom}$ [mm]			$h_{nom3}$			
			65	85	100	115
<b>steel failure for tension- and shear load</b>						
characteristic load	$N_{Rk,s,eq}$	[kN]	27.0	45.0	67.0	94.0
	$V_{Rk,s,eq}$	[kN]	8.5	15.3	21.0	22.4
partial safety factor	$\gamma_{Ms}$	[-]	1.5			
<b>pull-out failure</b>						
characteristic tension load in cracked concrete C20/25	$N_{Rk,p,eq}$	[kN]	12.0	Pull-out failure is not decisive		
<b>concrete cone failure</b>						
effective anchorage depth	$h_{ef}$	[mm]	52	68	80	92
concrete spacing	$s_{cr,N}$	[mm]	$3 \times h_{ef}$			
concrete edge distance	$c_{cr,N}$	[mm]	$1.5 \times h_{ef}$			
installation safety factor	$\gamma_{inst}$	[-]	1.0			
<b>concrete pry out failure (pry-out)</b>						
factor	$k_8$	[-]	1.0			
<b>concrete edge failure</b>						
effective length of anchor	$l_f = h_{ef}$	[mm]	52	68	80	92
outside diameter of anchor	$d_{nom}$	[mm]	8	10	12	14

**Würth Concrete Screw W-BS/S, W-BS/A4, W-BS/HCR**

**Performances**

Characteristic values for seismic category C1

**Annex C 4**

**Table C6: Characteristic values of resistance to fire exposure for W-BS**

Anchor size W-BS				6		8			10			12			14		
Nominal embedment depth	$h_{nom}$			1	2	1	2	3	1	2	3	1	2	3	1	2	3
	[mm]			40	55	45	55	65	55	75	85	65	85	100	75	100	115
<b>steel failure for tension- and shear load (<math>F_{Rk,s,fi} = N_{Rk,s,fi} = V_{Rk,s,fi}</math>)</b>																	
Fire resistance class																	
R30	Characteristic Resistance	$F_{Rk,s,fi30}$	[kN]	0,9	2,4	4,4	7,3	10,3									
R60		$F_{Rk,s,fi60}$	[kN]	0,8	1,7	3,3	5,8	8,2									
R90		$F_{Rk,s,fi90}$	[kN]	0,6	1,1	2,3	4,2	5,9									
R120		$F_{Rk,s,fi120}$	[kN]	0,4	0,7	1,7	3,4	4,8									
R30		$M^0_{Rk,s,fi30}$	[Nm]	0,7	2,4	5,9	12,3	20,4									
R60		$M^0_{Rk,s,fi60}$	[Nm]	0,6	1,8	4,5	9,7	15,9									
R90		$M^0_{Rk,s,fi90}$	[Nm]	0,5	1,2	3,0	7,0	11,6									
R120		$M^0_{Rk,s,fi120}$	[Nm]	0,3	0,9	2,3	5,7	9,4									
<b>edge distance</b>																	
R30 bis R120	$C_{cr, fi}$		[mm]	2 x $h_{ef}$													
<b>spacing</b>																	
R30 bis R120	$S_{cr, fi}$		[mm]	4 x $h_{ef}$													

The characteristic resistance to fire exposure for pull-out failure, concrete cone failure, concrete pry-out failure and concrete edge failure shall be calculated according to EN 1992-4. If no value for  $N_{Rk,p}$  is given, in the equation D.4 and D.5 the value of  $N^0_{Rk,c}$  shall be inserted instead of  $N_{Rk,p}$ .

**Würth Concrete Screw W-BS/S, W-BS/A4, W-BS/HCR**

**Performances**

Characteristic values of resistance to fire exposure

**Annex C 5**