

Approval body for construction products
and types of construction

Bautechnisches Prüfamt

An institution established by the Federal and
Laender Governments



European Technical Assessment

ETA-10/0457
of 22 March 2019

English translation prepared by DIBt - Original version in German language

General Part

Technical Assessment Body issuing the
European Technical Assessment:

Deutsches Institut für Bautechnik

Trade name of the construction product

Berner Simplexanchor BAZ

Product family
to which the construction product belongs

Mechanical anchor for use in concrete

Manufacturer

Berner Trading Holding GmbH
Bernerstraße 6
74653 Künzelsau
DEUTSCHLAND

Manufacturing plant

Berner Herstellwerk 6
Berner manufacturing plant 6

This European Technical Assessment
contains

18 pages including 3 annexes which form an integral part
of this assessment

This European Technical Assessment is
issued in accordance with Regulation (EU)
No 305/2011, on the basis of

EAD 330232-00-0601

This version replaces

ETA-10/0457 issued on 13 September 2016

The European Technical Assessment is issued by the Technical Assessment Body in its official language. Translations of this European Technical Assessment in other languages shall fully correspond to the original issued document and shall be identified as such.

Communication of this European Technical Assessment, including transmission by electronic means, shall be in full. However, partial reproduction may only be made with the written consent of the issuing Technical Assessment Body. Any partial reproduction shall be identified as such.

This European Technical Assessment may be withdrawn by the issuing Technical Assessment Body, in particular pursuant to information by the Commission in accordance with Article 25(3) of Regulation (EU) No 305/2011.

Specific Part

1 Technical description of the product

The Berner Simplexanchor BAZ is an anchor made of galvanised steel (BAZ) or made of stainless steel (BAZ A4) or high corrosion resistant steel (BAZ C) which is placed into a drilled hole and anchored by torque-controlled expansion.

The product description is given in Annex A.

2 Specification of the intended use in accordance with the applicable European Assessment Document

The performances given in Section 3 are only valid if the anchor is used in compliance with the specifications and conditions given in Annex B.

The verifications and assessment methods on which this European Technical Assessment is based lead to the assumption of a working life of the anchor of at least 50 years. The indications given on the working life cannot be interpreted as a guarantee given by the producer, but are to be regarded only as a means for choosing the right products in relation to the expected economically reasonable working life of the works.

3 Performance of the product and references to the methods used for its assessment

3.1 Mechanical resistance and stability (BWR 1)

Essential characteristic	Performance
Characteristic resistance to tension load (static and quasi-static loading)	See Annex C 1
Characteristic resistance to shear load (static and quasi-static loading)	See Annex C 2
Displacements (static and quasi-static loading)	See Annex C 5
Characteristic resistance and displacements for seismic performance categories C1 and C2	See Annex C 4 and C 5

3.2 Safety in case of fire (BWR 2)

Essential characteristic	Performance
Reaction to fire	Class A1
Resistance to fire	see Annex C 3

4 Assessment and verification of constancy of performance (AVCP) system applied, with reference to its legal base

In accordance with the European Assessment Document EAD Nr. 330232-00-0601 the applicable European legal act is: [96/582/EC].

The system to be applied is: 1

5 Technical details necessary for the implementation of the AVCP system, as provided for in the applicable European Assessment Document

Technical details necessary for the implementation of the AVCP system are laid down in the control plan deposited at Deutsches Institut für Bautechnik.

Issued in Berlin on 22 March 2019 by Deutsches Institut für Bautechnik

BD Dipl.-Ing. Andreas Kummerow
Head of Department

beglaubigt:
Baderschneider

Cone bolt manufactured by cold - forming:

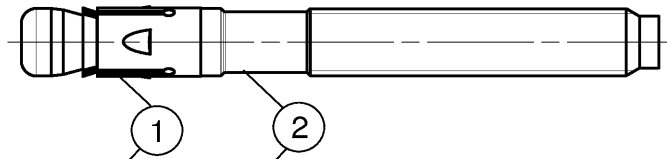

Cone bolt manufactured by turning:

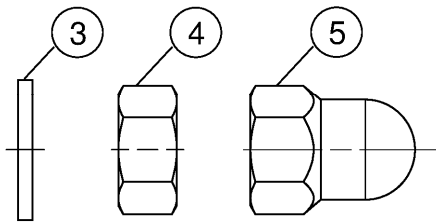
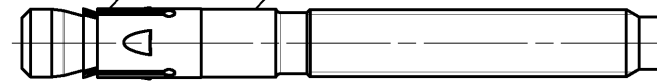

- ① Expansion sleeve
- ② Cone bolt (cold – formed or turned)
- ③ Washer
- ④ Hexagon nut
- ⑤ Berner BAZ dome nut

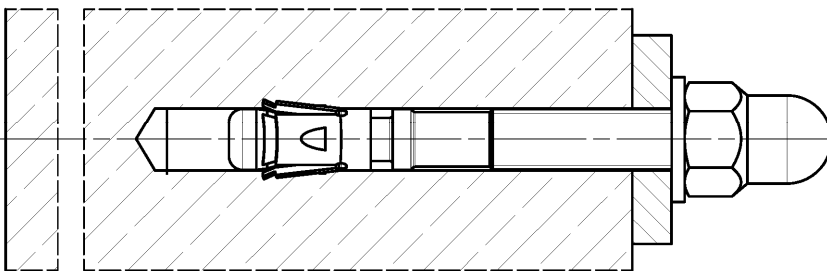
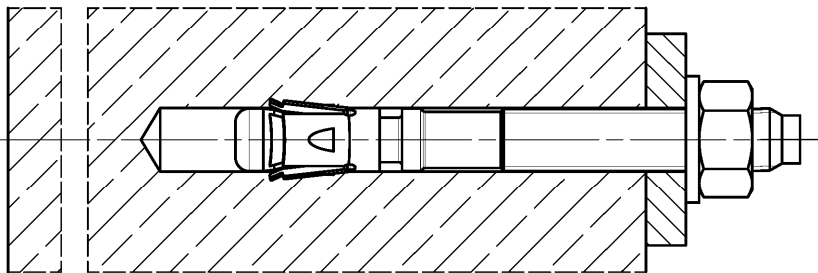

(Fig. not to scaled)

Berner Simplexanchor BAZ, BAZ A4, BAZ C

Product description
Installed condition

Annex A 1

Product label and letter-code:

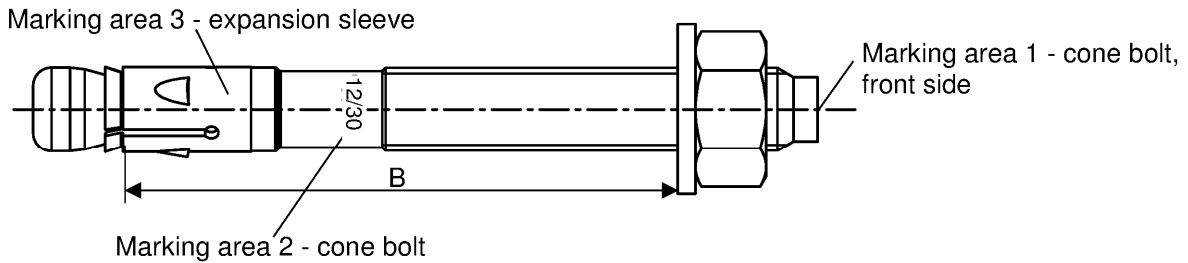

Product label, example:

BAZ 12/30 A4

Brand | type of fastener placed at marking area 2 or marking area 3

Thread size / max. thickness of the fixture (t_{fix}) identification A4 or C placed at marking area 2

- BAZ: carbon steel, galvanized
- BAZ A4: stainless steel
- BAZ C: high corrosion resistant steel

Table A2.1: Letter - code at marking area 1:

Marking	(a)	(b)	(c)	(d)	(A)	(B)	(C)	(D)	(E)	(F)	(G)	(H)	(I)	(K)	
Max. t_{fix}	5	10	15	20	5	10	15	20	25	30	35	40	45	50	
$B \geq [mm]$	M6	-				45	50	55	60	65	70	75	80	85	90
	M8	40	45	-		50	55	60	65	70	75	80	85	90	95
	M10	45	50	55	60	65	70	75	80	85	90	95	100	105	110
	M12	55	60	65	70	75	80	85	90	95	100	105	110	115	120
	M16	70	75	80	85	90	95	100	105	110	115	120	125	130	135
	M20	-				105	110	115	120	125	130	135	140	145	150
	M24	-				130	135	140	145	150	155	160	165	170	175
Marking	(L)	(M)	(N)	(O)	(P)	(R)	(S)	(T)	(U)	(V)	(W)	(X)	(Y)	(Z)	
Max. t_{fix}	60	70	80	90	100	120	140	160	180	200	250	300	350	400	
$B \geq [mm]$	M6	100	110	120	130	140	160	180	200	220	240	290	340	390	440
	M8	105	115	125	135	145	165	185	205	225	245	295	345	395	445
	M10	120	130	140	150	160	180	200	220	240	260	310	360	410	460
	M12	130	140	150	160	170	190	210	230	250	270	320	370	420	470
	M16	145	155	165	175	185	205	225	245	265	285	335	385	435	485
	M20	160	170	180	190	200	220	240	260	280	300	350	400	450	500
	M24	185	195	205	215	225	245	265	285	305	325	375	425	475	525

Calculation existing h_{ef} for installed fasteners:

$$\text{existing } h_{ef} = B_{(\text{according to table A2.1})} - \text{existing } t_{fix}$$

Thickness of the fixture t_{fix} including thickness of fastener plate t and e.g. thickness of grout layer t_{grout} or other non-structural layers

(Fig. not to scaled)

Berner Simplexanchor BAZ, BAZ A4, BAZ C

Product description
Product label and letter code

Annex A 2

Product dimensions

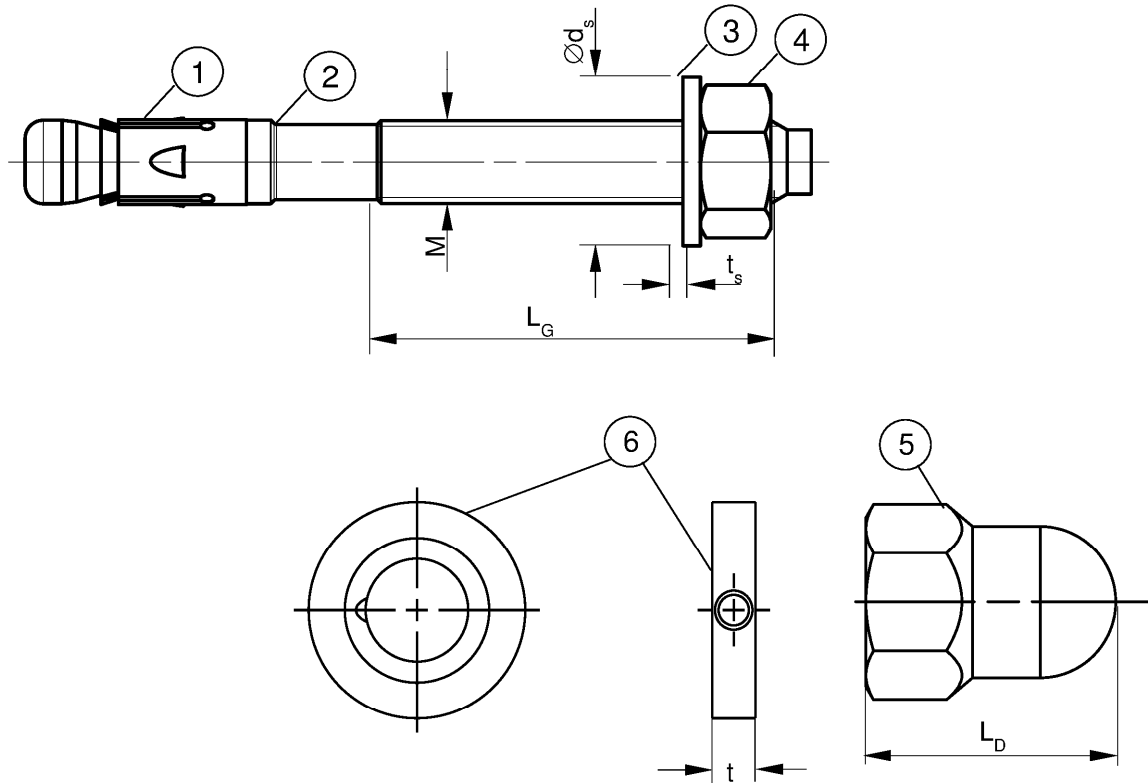

Table A3.1: Dimensions [mm]

Part	Designation		BAZ, BAZ A4, BAZ C						
			M6	M8	M10	M12	M16	M20	M24
1	Expansion sleeve	Sheet thickness	0,8	1,3	1,4	1,6	2,4		3,0
2	Cone bolt	Thread size M	6	8	10	12	16	20	24
		L_G	10	19	26	31	40	50	57
3	Washer	t_s	1,4		1,8	2,3	2,7		3,7
		$\varnothing d_s$	11	15	19	23	29	36	43
4 & 5	Hexagon nut / Berner BAZ dome nut	Wrench size	10	13	17	19	24	30	36
5		L_D	-		22	27	33	-	
6	Berner filling disc FFD	t	6				7	8	10

(Fig. not to scaled)

Berner Simplexanchor BAZ, BAZ A4, BAZ C

Product description
Dimensions

Annex A 3

Specifications of intended use

Anchorage subject to:

Size	BAZ, BAZ A4, BAZ C						
	M6	M8	M10	M12	M16	M20	M24
Static and quasi-static loads	✓						
Cracked and uncracked concrete							
Fire exposure							
Seismic performance category	C1	-			✓		
	C2 ¹⁾	-			✓		-

¹⁾ BAZ C: Only valid for cold-formed version (according to Annex A1)

Base materials:

- Compacted reinforced and unreinforced normal weight concrete without fibres (cracked and uncracked) according to EN 206:2013
- Strength classes C20/25 to C50/60 according to EN 206:2013

Use conditions (Environmental conditions):

- Structures subject to dry internal conditions (BAZ, BAZ A4, BAZ C)
- Structures subject to external atmospheric exposure (including industrial and marine environment) and to permanently damp internal condition, if no particular aggressive conditions exist (BAZ A4, BAZ C)
- Structures subject to external atmospheric exposure and permanently damp internal condition, if other particular aggressive conditions exist (BAZ C)

Note: Particular aggressive conditions are e.g. permanent, alternating immersion in seawater or the splash zone of seawater, chloride atmosphere of indoor swimming pools or atmosphere with extreme chemical pollution (e.g. in desulphurization plants or road tunnels where deicing materials are used)

Design:

- Anchorages are to be designed under the responsibility of an engineer experienced in anchorages and concrete work
- Verifiable calculation notes and drawings are to be prepared taking account of the loads to be anchored. The position of the anchor is indicated on the design drawings (e.g. position of the anchor relative to reinforcement or to supports, etc.)
- Design of fastenings according to EN 1992-4:2018 and EOTA Technical Report TR 055
- For effective embedment depth $h_{ef} < 40$ mm and $h_{min} \geq 80$ mm and < 100 mm only statically indeterminate fixings (e.g. light-weight suspended ceilings with internal exposure) are covered by the ETA

Berner Simplexanchor BAZ, BAZ A4, BAZ C

Intended Use
Specifications

Annex B 1

Table B2.1: Installation parameters

Size	BAZ, BAZ A4, BAZ C						
	M6	M8	M10	M12	M16	M20	M24
Nominal drill hole diameter $d_0 =$	6	8	10	12	16	20	24
Maximum bit diameter with hammer or hollow drilling $d_{cut,max}$ [mm]	6,40	8,45	10,45	12,5	16,5	20,55	24,55
Maximum bit diameter with diamond drilling	-	8,15		12,25	16,45	20,50	24,40
Overall fastener embedment depth in the concrete $h_{nom} \geq$ (L) [mm]	46,5 (6,5)	44,5 (9,5)	52,0 (12)	63,5 (13,5)	82,5 (17,5)	120 (20)	148,5 (23,5)
Depth of drill hole to deepest point $h_1 \geq$	Existing $h_{ef} + L = h_{nom}$					$h_{nom} + 10$	
Diameter of clearance hole in the fixture $d_f \leq$ [mm]	7	9	12	14	18	22	26
Required setting torque $T_{inst} =$ [Nm]	8	20	45	60	110	200	270
Excess length after hammering-in the cone bolt (for Berner dome nut applications according to Annex B6) $O =$ [mm]	-		12	16	20	-	

Setting gauge BAZ SL-H
for anchor with Berner BAZ dome nut:

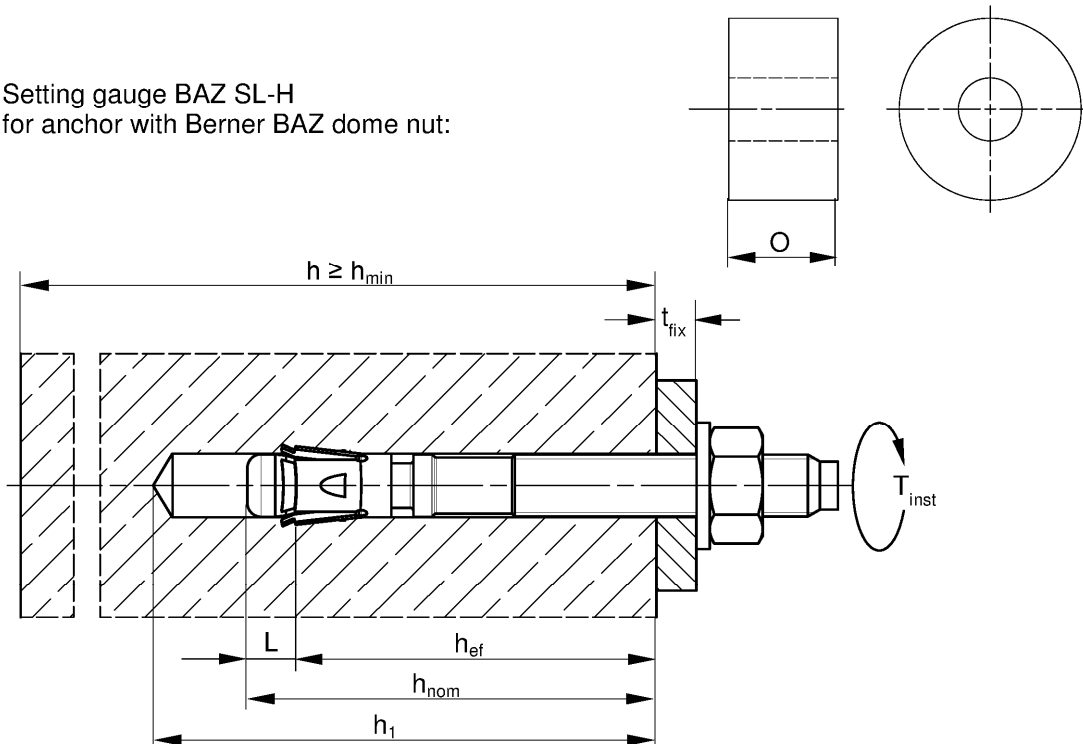

- h_{ef} = Effective embedment depth
- t_{fix} = Thickness of the fixture
- h_1 = Depth of drill hole to deepest point
- h = Thickness of the concrete member
- h_{min} = Minimum thickness of concrete member
- h_{nom} = Overall fastener embedment depth in the concrete
- T_{inst} = Required setting torque

(Fig. not to scaled)

Berner Simplexanchor BAZ, BAZ A4, BAZ C

Intended Use
Installation parameters

Annex B 2

Table B3.1: Minimum thickness of concrete members, minimum spacing and minimum edge distance

Size	BAZ, BAZ A4, BAZ C						
	M6	M8	M10	M12	M16	M20	M24
Minimum edge distance							
Uncracked concrete	45	40	45	55	65	95	135
Cracked concrete						85	100
Minimum spacing	according to Annex B4						
Minimum thickness of concrete member	80			100	140	160	200
Thickness of concrete member	max. { $h_{min}; h_1^{(1)} + 30$ }				max. { $h_{min}; h_1^{(1)} + 2 \cdot d_o$ }		
Minimum spacing							
Uncracked concrete	35	40	40	50	65	95	100
Cracked concrete		35					
Minimum edge distance	according to Annex B4						
Minimum thickness of concrete member	80			100	140	160	200
Thickness of concrete member	max. { $h_{min}; h_1^{(1)} + 30$ }				max. { $h_{min}; h_1^{(1)} + 2 \cdot d_o$ }		
Minimal splitting area							
Uncracked concrete	5,1	18	37	54	67	100	117,5
Cracked concrete							

¹⁾ h_1 according to Annex B2

Splitting failure applied for minimum edge distance and spacing in dependence of the h_{ef}

For the calculation of minimum spacing and minimum edge distance of anchors in combination with different embedment depths and thicknesses of concrete members the following equation shall be fulfilled:

$$A_{sp,req} < A_{sp,ef}$$

$A_{sp,req}$ = required splitting area

$A_{sp,ef}$ = effective splitting area (according to Annex B4)

Berner Simplexanchor BAZ, BAZ A4, BAZ C

Intended Use

Minimum thickness of member, minimum spacing and edge distance

Annex B 3

Table B4.1: Effective splitting area $A_{sp,ef}$ with member thickness $h > h_{ef} + 1,5 \cdot c$ and $h \geq h_{min}$

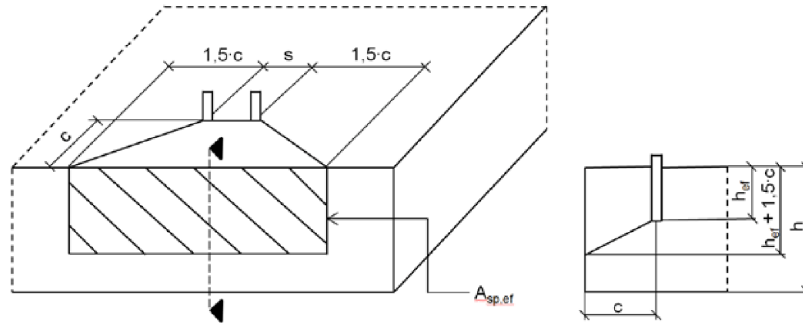

Single anchor and group of anchors with $s > 3 \cdot c$	$A_{sp,ef} = (6 \cdot c) \cdot (h_{ef} + 1,5 \cdot c)$	[mm ²]	with $c \geq c_{min}$
Group of anchors with $s \leq 3 \cdot c$	$A_{sp,ef} = (3 \cdot c + s) \cdot (h_{ef} + 1,5 \cdot c)$	[mm ²]	with $c \geq c_{min}$ and $s \geq s_{min}$

Table B4.2: Effective splitting area $A_{sp,ef}$ with member thickness $h \leq h_{ef} + 1,5 \cdot c$ and $h \geq h_{min}$

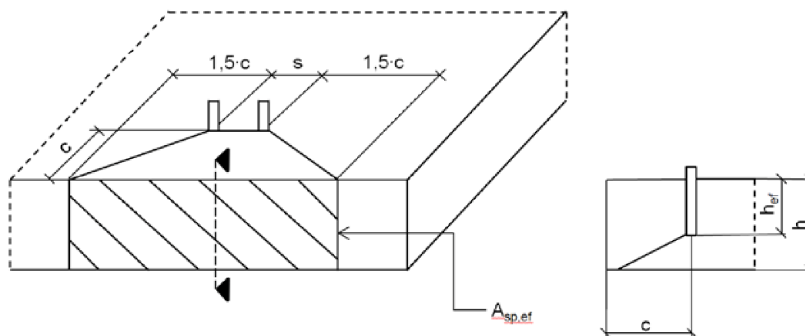

Single anchor and group of anchors with $s > 3 \cdot c$	$A_{sp,ef} = 6 \cdot c \cdot \text{existing } h$	[mm ²]	with $c \geq c_{min}$
Group of anchors with $s \leq 3 \cdot c$	$A_{sp,ef} = (3 \cdot c + s) \cdot \text{existing } h$	[mm ²]	with $c \geq c_{min}$ and $s \geq s_{min}$

Edge distance and axial spacing shall be rounded to at least 5 mm

(Fig. not to scaled)

Berner Simplexanchor BAZ, BAZ A4, BAZ C

Intended Use

Minimum thickness of member, minimum spacings and edge distances





Annex B 4

Installation instructions:

- Anchor installation carried out by appropriately qualified personnel and under the supervision of the person responsible for technical matters of the site
- Use of the anchor only as supplied by the manufacturer without exchanging the components of the anchor
Exception: Berner BAZ dome nut.
- Hammer, hollow or diamond drilling according to Annex B5
- Drill hole created perpendicular $\pm 5^\circ$ to concrete surface, positioning without damaging the reinforcement
- In case of aborted hole: new drilling at a minimum distance twice the depth of the aborted drill hole or smaller distance if the aborted drill hole is filled with high strength mortar and if under shear or oblique tension load it is not in the direction of load application

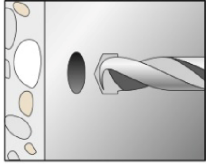
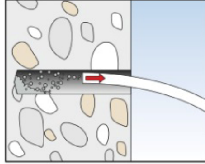
Installation instructions: Drilling and cleaning the hole

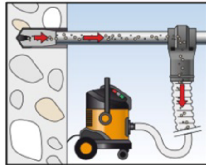
Types of drills and cleaning

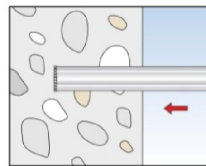
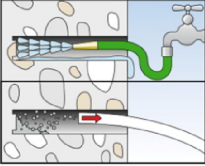
Types of drills and cleaning			
Hammer drill		 1: Drill the hole	 2: Clean the hole
Hollow drill		 1: Drill the hole with automatic cleaning	-
Diamond drill, for non seismic applications only and \geq drill \varnothing 8		 1: Drill the hole	 2: Clean the hole

Berner Simplexanchor BAZ, BAZ A4, BAZ C

Intended Use
Installation instructions

Annex B 5

Installation instructions: Installation of the anchor

HEXAGON NUT:

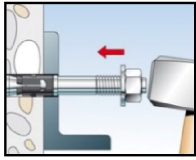

3: Set the fastener

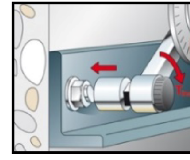

4: Apply T_{inst}

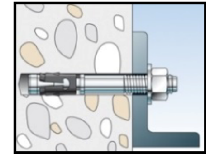

5: Installed fastener

Berner BAZ DOME NUT:

Option 1: Push through installation with setting gauge SL-H:

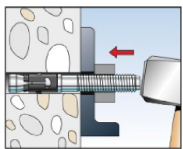

3: Set the fastener
using setting
gauge

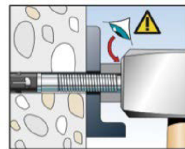

4: Check offset

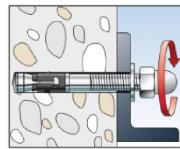

5: Turn on the
washer and
Berner BAZ
dome nut

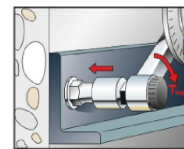

6: Apply T_{inst}

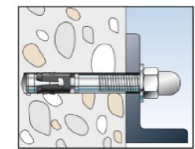

7: Installed fastener

Option 2: Push through installation with hexagon nut:

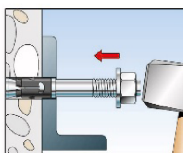

3: Set the fastener

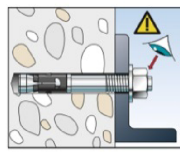

4: check setting
position: Visible one
turn of a thread

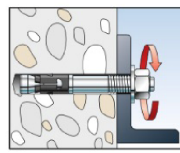

4.1: Remove nut

Berner FILLING DISC FFD optional for seismic C2 application or minimizing the annular gap:

Optional

The gap between bolt and fixture may be filled with mortar (compressive strength $\geq 50 \text{ N/mm}^2$ e.g. MCS UNI Plus) after step 7 (for eliminating the annular gap).
The filling disc is additional to the standard washer.
The thickness of the filling disc must be considered for definition of t_{fix}
Countersunk of the filling disc in direction to the anchor plate.

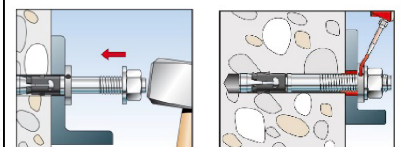

Berner Simplexanchor BAZ, BAZ A4, BAZ C

Intended Use
Installation instructions

Annex B 6

Table C1.1: Characteristic tension resistance under static and quasi-static action												
Size	BAZ, BAZ A4, BAZ C											
	M6	M8	M10	M12	M16	M20	M24					
Steel failure												
Characteristic resistance	BAZ	$N_{Rk,s}$ [kN]		7,6	16,6	28,3	43,2	67,0	123,3	176,7		
	BAZ A4/C			11,4	17,0	29,0	44,3	70,6	124,9	183,6		
Partial factor for steel failure	γ_{Ms} ¹⁾ [-]		1,5									
Pullout failure												
Effective embedment depth for calculation	h_{ef} [mm]		40	35 - < 45	45	40 - 60	50 - 70	65 - 85	100	125		
Characteristic resistance in cracked concrete C20/25	$N_{Rk,p}$ [kN]		1,5	5,5	8	13	20	- ²⁾				
Characteristic resistance in uncracked concrete C20/25			10,5	14		20	22					
Increasing factors for $N_{Rk,p}$ for cracked and uncracked concrete	ψ_c		C25/30		1,12							
			C30/37		1,22							
			C35/45		1,32							
			C40/50		1,41							
			C45/55		1,50							
			C50/60		1,58							
Installation factor	γ_{inst} [-]		1,0									
Concrete cone and splitting failure												
Factor for uncracked concrete	$k_1 = k_{Ucr,N}$ [-]		11,0									
Factor for cracked concrete	$k_1 = k_{Cr,N}$ [-]		7,7									
Characteristic spacing	$s_{cr,N}$ [mm]		$3 \cdot h_{ef}$									
Characteristic edge distance	$c_{cr,N}$ [mm]		$1,5 \cdot h_{ef}$									
Spacing	$s_{cr,sp}$		$2 \cdot c_{cr,sp}$									
Edge distance for h = 80	$c_{cr,sp}$ [mm]		40	$2,4 \cdot h_{ef}$		$2 \cdot h_{ef}$	-					
Edge distance for h = 100				$2 \cdot h_{ef}$		$2,4 \cdot h_{ef}$	$2 \cdot h_{ef}$		-			
Edge distance for h = 120								$2,1 \cdot h_{ef}$		-		
Edge distance for h = 140						$1,9 \cdot h_{ef}$		$1,5 \cdot h_{ef}$	$2 \cdot h_{ef}$	-		
Edge distance for h = 160										$2,4 \cdot h_{ef}$	-	
Edge distance for h = 200												$2,2 \cdot h_{ef}$
¹⁾ In absence of other national regulations ²⁾ Pullout failure not relevant												
Berner Simplexanchor BAZ, BAZ A4, BAZ C								Annex C 1				
Performances Characteristic values of resistance under tension loads												

Table C2.1: Characteristic values of **shear** resistance under static and quasi-static action

Size	BAZ, BAZ A4, BAZ C								
	M6	M8	M10	M12	M16	M20	M24		
Steel failure without lever arm									
Characteristic resistance	$\frac{\text{BAZ}}{\text{BAZ A4/C}}$	$V_{Rk,s}^0$ [kN]	5,9	13,6	21,4	30,6	55,0	81,4	110,1
Partial factor for steel failure		γ_{Ms}^1 [-]	1,25						
Ductility factor		k_7	1,0						
Steel failure with lever arm and Concrete pryout failure									
Effective embedment depth for calculation		h_{ef} [mm]	40	45	60	70	85	100	125
Characteristic bending resistance	$\frac{\text{BAZ}}{\text{BAZ A4/C}}$	$M_{Rk,s}^0$ [Nm]	11,4	26	52	92	233	513	865
Factor for pryout failure		k_8 [-]	2,6	2,8	3,2	3,0	2,6	2,4	
Effective embedment depth for calculation		h_{ef} [mm]		35 - < 45	40 - < 60	50 - < 70	65 - < 85		
Characteristic bending resistance	$\frac{\text{BAZ}}{\text{BAZ A4/C}}$	$M_{Rk,s}^0$ [Nm]	-	20	44	92	184	-	
Factor for pryout failure		k_8 [-]		21	45	100	193		
Partial factor for steel failure		γ_{Ms}^1 [-]	1,25						
Ductility factor		k_7	1,0						
Concrete edge failure									
Effective embedment depth for calculation		$l_f =$ [mm]	h_{ef}						
Outside diameter of a fastener		d_{nom}	6	8	10	12	16	20	24
¹⁾ In absence of other national regulations									
Berner Simplexanchor BAZ, BAZ A4, BAZ C							Annex C 2		
Performances Characteristic values of resistance under shear loads									

Table C3.1: Characteristic values of tension resistance under fire exposure

Size		BAZ, BAZ A4, BAZ C							
		M6	M8	M10	M12	M16	M20	M24	
$h_{ef} \geq$ [mm]		40	35 / 45	40 / 60	50 / 70	65 / 85	100	125	
Characteristic resistance steel failure	$N_{Rk,s,fi}$	R30	0,6 ¹⁾ / 0,9 ²⁾	1,4	2,8	5,0	9,4	14,7	21,1
		R60	0,4 ¹⁾ / 0,9 ²⁾	1,2	2,3	4,1	7,7	12,0	17,3
		R90	0,3 ¹⁾ / 0,9 ²⁾	0,9	1,9	3,2	6,0	9,4	13,5
		R120	0,2 ¹⁾ / 0,7 ²⁾	0,8	1,6	2,8	5,2	8,1	11,6
Characteristic resistance Concrete cone failure	$N_{Rk,c,fi}$	R30 - R90	$7,7 \cdot h_{ef}^{1,5} \cdot (20)^{0,5} \cdot h_{ef} / 200 / 1000$						
		R120	$7,7 \cdot h_{ef}^{1,5} \cdot (20)^{0,5} \cdot h_{ef} / 200 / 1000 \cdot 0,8$						
Characteristic resistance pullout failure	$N_{Rk,p,fi}$	R30	0,4	0,9 / 2,0	2,2 / 3,3	3,0 / 5,0	4,5 / 6,8	8,6	12,0
		R60		0,8 / 2,0					
		R90	0,5 / 2,0						
		R120	0,3	0,3 / 1,6	1,7 / 2,6	2,4 / 4,0	3,6 / 5,4	6,9	9,6

¹⁾ BAZ gvz

²⁾ BAZ A4 / C

Table C3.2: Characteristic values of shear resistance under fire exposure

Size BAZ, BAZ A4, BAZ C		R30		R60	
		$V_{Rk,s,fi,30}$ [kN]	$M^0_{Rk,s,fi,30}$ [Nm]	$V_{Rk,s,fi,60}$ [kN]	$M^0_{Rk,s,fi,60}$ [Nm]
M6	40	0,6 ¹⁾ / 0,9 ²⁾	0,5 ¹⁾ / 0,2 ²⁾	0,4 ¹⁾ / 0,9 ²⁾	0,3 ¹⁾ / 0,1 ²⁾
M8	35	1,8	1,4	1,6	1,2
M10	40	3,6		2,9	3,0
M12	50	6,3	7,8	4,9	6,4
M16	65	11,7	19,9	9,1	16,3
M20	100	18,2	39,0	14,2	31,8
M24	125	26,3	67,3	20,5	55,0

Size BAZ, BAZ A4, BAZ C		R90		R120	
		$V_{Rk,s,fi,90}$ [kN]	$M^0_{Rk,s,fi,90}$ [Nm]	$V_{Rk,s,fi,120}$ [kN]	$M^0_{Rk,s,fi,120}$ [Nm]
M6	40	0,3 ¹⁾ / 0,9 ²⁾	0,2 ¹⁾ / 0,1 ²⁾	0,2 ¹⁾ / 0,7 ²⁾	0,2 ¹⁾ / 0,1 ²⁾
M8	35	1,3	1,0	1,2	0,8
M10	40	2,2	2,4	1,9	2,1
M12	50	3,5	5,0	2,8	4,3
M16	65	6,6	12,6	5,3	11,0
M20	100	10,3	24,6	8,3	21,4
M24	125	14,8	42,6	11,9	37,0

¹⁾ BAZ gvz

²⁾ BAZ A4 / C

Table C3.3: Minimum spacings and minimum edge distances of anchors under fire exposure for tension and shear load

Size		BAZ, BAZ A4, BAZ C						
		M6	M8	M10	M12	M16	M20	M24
Spacing	s_{min}	Annex B3						
Edge distance	c_{min} [mm]	$c_{min} = 2 \cdot h_{ef}$ for fire exposure from more than one side $c_{min} \geq 300$ mm						

Berner Simplexanchor BAZ, BAZ A4, BAZ C

Performances
Characteristic values of resistance under fire exposure

Annex C 3

Table C4.1: Characteristic values of tension and shear resistance under seismic action category C1

Size	BAZ, BAZ A4, BAZ C						
	M6	M8	M10	M12	M16	M20	M24
Length of anchor L_{max} [mm]	-	167	186	221	285	394	477
Effective embedment depth h_{ef} [mm]	-	45	40 - 60	50 - 70	65 - 85	100	125
Steel failure							
Characteristic resistance tension load C1 $N_{Rk,s,eq,C1}$ [kN]	-	16,0	27,0	41,0	66,0	111,0	150,0
Partial factor for steel failure $\gamma_{Ms,C1}^{1)}$ [-]	-	1,5					
Pullout failure							
Characteristic resistance tension load in cracked concrete C1 $N_{Rk,p,eq,C1}$ [kN]	-	4,6	8,0	16,0	28,2	36,0	50,3
Installation factor γ_{inst} [-]	-	1,0					
Steel failure without lever arm							
Characteristic resistance shear load C1 $V_{Rk,s,eq,C1}$ [kN]	-	11	17	27	47	56	69
Partial factor for steel failure $\gamma_{Ms,C1}^{1)}$ [-]	-	1,25					

¹⁾ In absence of other national regulations

Table C4.2: Characteristic values of tension and shear resistance under seismic action category C2

Size	BAZ, BAZ A4, BAZ C ¹⁾						
	M6	M8	M10	M12	M16	M20	M24
Length of anchor L_{max} [mm]	-	-	186	221	285	394	-
Steel failure							
Characteristic resistance tension load C2 $N_{Rk,s,eq,C2}$ [kN]	-	-	27	41	66	111	-
Partial factor for steel failure $\gamma_{Ms,C2}^{2)}$ [-]	-	-	1,5				-
Pullout failure							
Characteristic resistance tension load in cracked concrete C2	h_{ef} [mm]	-	60	70	85	100	-
	$N_{Rk,p,eq,C2}$ [kN]	-	5,1	7,4	21,5	30,7	-
	h_{ef} [mm]	-	40-59	50-69	65-84	-	-
	$N_{Rk,p,eq,C2}$ [kN]	-	2,7	4,4	16,4	-	-
Installation factor γ_{inst} [-]	-	-	1,0				-
Steel failure without lever arm							
Characteristic resistance shear load C2	h_{ef} [mm]	-	60	70	85	100	-
	$V_{Rk,s,eq,C2}$ [kN]	-	10,0	17,4	27,5	39,9	-
	h_{ef} [mm]	-	40-59	50-69	65-84	-	-
	$V_{Rk,s,eq,C2}$ [kN]	-	7,0	12,7	22,0	-	-
Partial factor for steel failure $\gamma_{Ms,C2}^{2)}$ [-]	-	-	1,25				-
Factor for annular gap α_{gap} [-]	-	-	0,5 (1,0) ³⁾				-

¹⁾ BAZ C: Only valid for cold-formed version (according to Annex A1)

²⁾ In absence of other national regulations

³⁾ Value in brackets valid for filled annular gap between anchor and clearance hole in the fixture. Use of special Upat filling Disc FFD is required.

Berner Simplexanchor BAZ, BAZ A4, BAZ C	Annex C 4
Performances Characteristic values of resistance under tension and shear loads under seismic action	

Table C5.1: Displacements under tension loads

Size	BAZ, BAZ A4, BAZ C						
	M6	M8	M10	M12	M16	M20	M24
Displacement – factor for tensile load¹⁾							
δ_{N0} - factor	0,13	0,22	0,12	0,09	0,08	0,07	0,05
	1,00	0,78	0,40	0,19	0,09		0,07
$\delta_{N\infty}$ - factor	0,16	0,07	0,05	0,06		0,05	0,04
	0,24	0,29	0,21	0,14	0,10	0,06	0,05

Table C5.2: Displacements under shear loads

Size	BAZ						
	M6	M8	M10	M12	M16	M20	M24
Displacement – factor for shear load²⁾							
δ_{V0} - factor	0,6	0,35	0,37	0,27	0,10	0,09	0,07
	0,9	0,52	0,55	0,40	0,14	0,15	0,11
$\delta_{V\infty}$ - factor	BAZ A4, BAZ C						
	0,6	0,23	0,19	0,18	0,10	0,11	0,07
	0,9	0,27	0,22	0,16	0,11	0,05	0,09

¹⁾ Calculation of effective displacement:

$$\delta_{N0} = \delta_{N0} - \text{factor} \cdot N_{ED}$$

$$\delta_{N\infty} = \delta_{N\infty} - \text{factor} \cdot N_{ED}$$

(N_{ED} : Design value of the applied tension force)

²⁾ Calculation of effective displacement:

$$\delta_{V0} = \delta_{V0} - \text{factor} \cdot V_{ED}$$

$$\delta_{V\infty} = \delta_{V\infty} - \text{factor} \cdot V_{ED}$$

(V_{ED} : Design value of the applied shear force)

Table C5.3: Displacements under tension loads for seismic category C2 for all embedment depths

Size	BAZ, BAZ A4, BAZ C						
	M6	M8	M10	M12	M16	M20	M24
Displacement DLS	$\delta_{N,eq(DLS)}$		2,7	4,4		5,6	-
Displacement ULS	$\delta_{N,eq(ULS)}$		11,5	13,0	12,3	14,4	-

Table C5.4: Displacements under shear loads for seismic category C2 for all embedment depths

Size	BAZ, BAZ A4, BAZ C						
	M6	M8	M10	M12	M16	M20	M24
Displacement DLS	$\delta_{V,eq(DLS)}$		4,1	4,7	5,5	4,8	-
Displacement ULS	$\delta_{V,eq(ULS)}$		6,2	7,8	10,1	11,2	-

Berner Simplexanchor BAZ, BAZ A4, BAZ C

Performances
Displacements under tension and shear loads

Annex C 5