

Approval body for construction products
and types of construction

Bautechnisches Prüfamt

An institution established by the Federal and
Laender Governments



European Technical Assessment

ETA-12/0028
of 11 April 2019

English translation prepared by DIBt - Original version in German language

General Part

Technical Assessment Body issuing the
European Technical Assessment:

Deutsches Institut für Bautechnik

Trade name of the construction product

Injection system Hilti HIT-HY 200-R

Product family
to which the construction product belongs

Bonded anchor for use in concrete

Manufacturer

Hilti AG
Feldkircherstraße 100
9494 Schaan
FÜRSTENTUM LIECHTENSTEIN

Manufacturing plant

Hilti Werke

This European Technical Assessment
contains

20 pages including 3 annexes which form an integral part
of this assessment

This European Technical Assessment is
issued in accordance with Regulation (EU)
No 305/2011, on the basis of

EAD 330499-00-0601

This version replaces

ETA-12/0028 issued on 30 May 2017

The European Technical Assessment is issued by the Technical Assessment Body in its official language. Translations of this European Technical Assessment in other languages shall fully correspond to the original issued document and shall be identified as such.

Communication of this European Technical Assessment, including transmission by electronic means, shall be in full. However, partial reproduction may only be made with the written consent of the issuing Technical Assessment Body. Any partial reproduction shall be identified as such.

This European Technical Assessment may be withdrawn by the issuing Technical Assessment Body, in particular pursuant to information by the Commission in accordance with Article 25(3) of Regulation (EU) No 305/2011.

Specific Part

1 Technical description of the product

The injection system Hilti HIT-HY 200-R with HIT-Z / HIT-Z-F / HIT-Z-R is a bonded anchor consisting of a foil pack with injection mortar Hilti HIT-HY 200-R and an anchor rod (including nut and washer) in the sizes of M8, M10, M12, M16 and M20. The anchor rod (including nut and washer) is made of galvanised steel (HIT-Z), with multilayer coating (HIT-Z-F) or stainless steel (HIT-Z-R). The anchor rod is placed into a drill hole filled with injection mortar. The load transfer is realised by mechanical interlock of several cones in the bonding mortar and then via a combination of bonding and friction forces in the base material (concrete).

The product description is given in Annex A.

2 Specification of the intended use in accordance with the applicable European Assessment Document

The performances given in Section 3 are only valid if the anchor is used in compliance with the specifications and conditions given in Annex B.

The verifications and assessment methods on which this European Technical Assessment is based lead to the assumption of a working life of the anchor of at least 50 years. The indications given on the working life cannot be interpreted as a guarantee given by the producer, but are to be regarded only as a means for choosing the right products in relation to the expected economically reasonable working life of the works.

3 Performance of the product and references to the methods used for its assessment

3.1 Mechanical resistance and stability (BWR 1)

Essential characteristic	Performance
Characteristic resistance for static and quasi-static tension load	See Annex C1
Characteristic resistance for static and quasi-static shear load	See Annex C2
Displacements (static and quasi-static loading)	See Annex C3
Characteristic resistance and displacements for seismic performance categories C1 and C2	See Annex C4 – C6

3.2 Hygiene, health and the environment (BWR 3)

Essential characteristic	Performance
Content, emission and/or release of dangerous substances	No performance assessed

4 Assessment and verification of constancy of performance (AVCP) system applied, with reference to its legal base

In accordance with EAD 330499-00-0601 the applicable European legal act is: [96/582/EC]

The system to be applied is: 1

5 Technical details necessary for the implementation of the AVCP system, as provided for in the applicable EAD

Technical details necessary for the implementation of the AVCP system are laid down in the control plan deposited with Deutsches Institut für Bautechnik.

Issued in Berlin on 11 April 2019 by Deutsches Institut für Bautechnik

BD Dipl.-Ing. Andreas Kummerow
Head of Department

beglaubigt:
Lange

Installed condition

Figure A1:

HIT-Z, HIT-Z-F, HIT-Z-R

Pre-setting:

Install anchor before positioning fixture

Through-setting:

Install anchor through positioned fixture

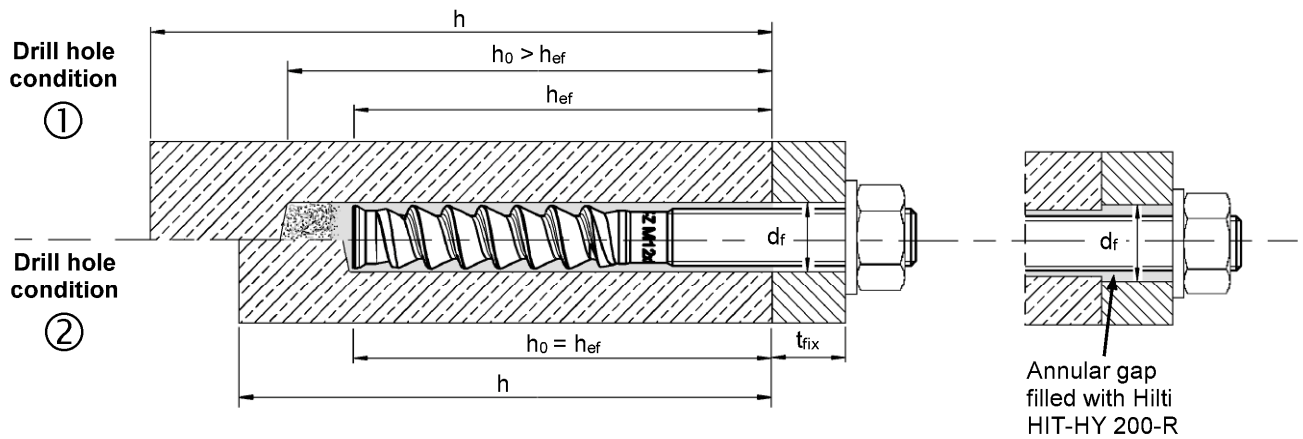

Drill hole condition ① → non-cleaned drill hole

Drill hole condition ② → drilling dust is removed

Injection system Hilti HIT-HY 200-R with HIT-Z / HIT-Z F / HIT-Z-R

Product description
Installed condition

Annex A1

Product description: Injection mortar and steel elements

Injection mortar Hilti HIT-HY 200-R: hybrid system with aggregate
330 ml and 500 ml

Marking:
HILTI HIT
HY 200-R
Production number and
production line
Expiry date mm/yyyy



Product name: "Hilti HIT-HY 200-R"

Static mixer Hilti HIT-RE-M



Steel elements

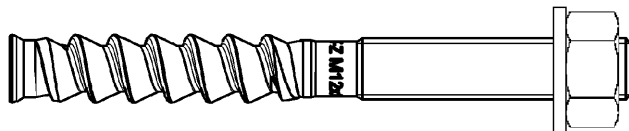

Hilti anchor rod: HIT-Z and HIT-Z-R: M8 to M20

Hilti anchor rod: HIT-Z F: M16 and M20

Steel elements Seismic filling set

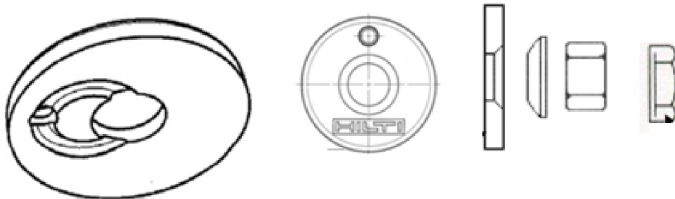

Injection system Hilti HIT-HY 200-R with HIT-Z / HIT-Z F / HIT-Z-R

Product description
Injection mortar / Static mixer / Steel elements

Annex A2

Table A1: Materials

Designation	Material
Metal parts made of zinc coated steel	
Anchor rod HIT-Z	For \leq M12: $f_{uk} = 650 \text{ N/mm}^2$, $f_{yk} = 520 \text{ N/mm}^2$, For M16: $f_{uk} = 610 \text{ N/mm}^2$, $f_{yk} = 490 \text{ N/mm}^2$, For M20: $f_{uk} = 595 \text{ N/mm}^2$, $f_{yk} = 480 \text{ N/mm}^2$, Elongation at fracture ($l_0=5d$) > 8% ductile; Electroplated zinc coated $\geq 5 \mu\text{m}$
Washer	Electroplated zinc coated $\geq 5 \mu\text{m}$
Nut	Strength class of nut adapted to strength class of anchor rod. Electroplated zinc coated $\geq 5 \mu\text{m}$
Metal parts made of seismic filling set	
Filling washer	Electroplated zinc coated $\geq 5 \mu\text{m}$
Spherical washer	Electroplated zinc coated $\geq 5 \mu\text{m}$
Metal parts made of multilayer coating steel	
Anchor rod HIT-Z-F	For M16: $f_{uk} = 610 \text{ N/mm}^2$, $f_{yk} = 490 \text{ N/mm}^2$, For M20: $f_{uk} = 595 \text{ N/mm}^2$, $f_{yk} = 480 \text{ N/mm}^2$, Elongation at fracture ($l_0=5d$) > 8% ductile; Multilayer coating, ZnNi-galvanized according to DIN 50979:2008-07
Washer	Multilayer coating, ZnNi-galvanized according to DIN 50979:2008-07
Nut	Multilayer coating, ZnNi-galvanized according to DIN 50979:2008-07
Metal parts made of stainless steel	
Anchor rod HIT-Z-R	For \leq M12: $f_{uk} = 650 \text{ N/mm}^2$, $f_{yk} = 520 \text{ N/mm}^2$, For M16: $f_{uk} = 610 \text{ N/mm}^2$, $f_{yk} = 490 \text{ N/mm}^2$, For M20: $f_{uk} = 595 \text{ N/mm}^2$, $f_{yk} = 480 \text{ N/mm}^2$, Elongation at fracture ($l_0=5d$) > 8% ductile; Stainless steel 1.4401, 1.4404 EN 10088-1:2014
Washer	Stainless steel A4 according to EN 10088-1:2014
Nut	Strength class of nut adapted to strength class of anchor rod. Stainless steel 1.4401, 1.4404 EN 10088-1:2014

Injection system Hilti HIT-HY 200-R with HIT-Z / HIT-Z F / HIT-Z-R

Product description
Materials

Annex A3

Specifications of intended use

Anchorage subject to:

- Static and quasi static loading
 - HIT-Z and HIT-Z-R size M8 to M20. HIT-Z-F sizes M16 and M20
- Seismic performance category:
 - Seismic C1: HIT-Z, HIT-Z-R sizes M8 to M20, HIT-Z-F sizes M16 and M20 in hammer drilled holes.
 - Seismic C2: HIT-Z, HIT-Z-R sizes M12 to M20, HIT-Z-F sizes M16 and M20 in hammer drilled holes.

Base material:

- Reinforced or unreinforced normal weight concrete without fibres according to EN 206:2013.
- Strength classes C20/25 to C50/60 according to EN 206:2013.
- Cracked and uncracked concrete.

Temperature in the base material:

- **at installation**
+5 °C to +40 °C
- **in-service**
 - Temperature range I: -40 °C to +40 °C
(max. long term temperature +24 °C and max. short term temperature +40 °C)
 - Temperature range II: -40 °C to +80 °C
(max. long term temperature +50 °C and max. short term temperature +80 °C)
 - Temperature range III: -40 °C to +120 °C
(max. long term temperature +72 °C and max. short term temperature +120 °C)

Use conditions (Environmental conditions):

- Structures subject to dry internal conditions (zinc coated steel, multilayer coated steel and stainless steel).
- Structures subject to external atmospheric exposure (including industrial and marine environment) and to permanently damp internal conditions, if no particular aggressive conditions exist (stainless steel).
Note: Particular aggressive conditions are e.g. permanent, alternating immersion in seawater or the splash zone of seawater, chloride atmosphere of indoor swimming pools or atmosphere with extreme chemical pollution (e.g. in desulphurization plants or road tunnels where de-icing products are used).

Design:

- Anchorages are designed under the responsibility of an engineer experienced in anchorages and concrete work.
- Verifiable calculation notes and drawings are prepared taking account of the loads to be anchored. The position of the anchor is indicated on the design drawings (e. g. position of the anchor relative to reinforcement or to supports, etc.).
- The anchorages are designed in accordance to EN 1992-4:2018 and EOTA Technical Report TR 055.

Installation:

- Concrete condition I1:
Installation in dry or wet (water saturated) concrete and use in service in dry or wet concrete.
- Installation direction:
D3: downward and horizontal and upward (e.g. overhead).
- Drilling technique:
hammer drilling, diamond coring or hammer drilling with hollow drill bit TE-CD, TE-YD
- Anchor installation carried out by appropriately qualified personnel and under the supervision of the person responsible for technical matters of the site.

Injection system Hilti HIT-HY 200-R with HIT-Z / HIT-Z-F / HIT-Z-R

Intended Use
Specifications

Annex B1

Table B1: Installation parameters HIT-Z, HIT-Z-F and HIT-Z-R

			M8	M10	M12	M16	M20
Nominal diameter	d	[mm]	8	10	12	16	20
Nominal diameter of drill bit	d ₀	[mm]	10	12	14	18	22
Length of anchor	min l	[mm]	80	95	105	155	215
	max l	[mm]	120	160	196	420	450
Length of helix	l _{Helix}	[mm]	50	60	60	96	100
Effective embedment depth	h _{ef,min}	[mm]	60	60	60	96	100
	h _{ef,max}	[mm]	100	120	144	192	220
Drill hole condition ① Minimum thickness of concrete member	h _{min}	[mm]	h _{ef} + 60 mm			h _{ef} + 100 mm	
Drill hole condition ② Minimum thickness of concrete member	h _{min}	[mm]	h _{ef} + 30 mm ≥ 100 mm			h _{ef} + 45 mm	
Maximum depth of drill hole	h ₀	[mm]	h – 30 mm			h – 2 d ₀	
Pre-setting: Maximum diameter of clearance hole in the fixture	d _f	[mm]	9	12	14	18	22
Through-setting: Maximum diameter of clearance hole in the fixture	d _f	[mm]	11	14	16	20	24
Maximum fixture thickness	t _{fix}	[mm]	48	87	120	303	326
Maximum fixture thickness with seismic filling set	t _{fix}	[mm]	41	79	111	292	314
Installation torque moment	T _{inst}	[Nm]	10	25	40	80	150

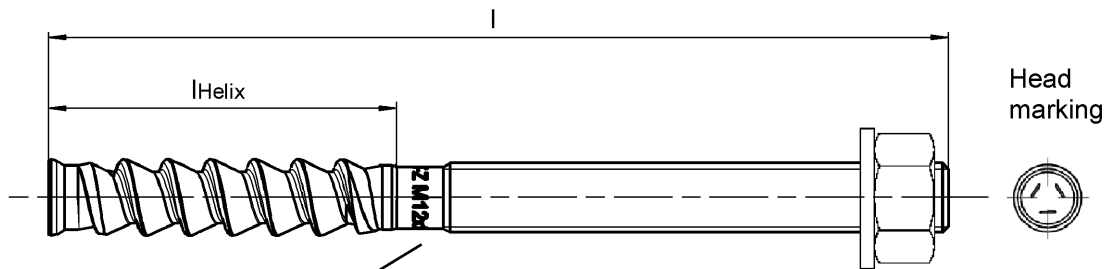

Marking:

Embossing "HIT-Z M...x l" zinc coated steel
 Embossing "HIT-Z-F M...x l" multilayer coating, ZnNi-galvanized
 Embossing "HIT-Z-R M...x l" stainless steel

Injection system Hilti HIT-HY 200-R with HIT-Z / HIT-Z-F / HIT-Z-R

Intended Use
Installation parameters

Annex B2

Minimum edge distance and spacing

For the calculation of minimum spacing and minimum edge distance of anchors in combination with different embedment depth and thickness of concrete member the following equation shall be fulfilled:

$$A_{i,req} < A_{i,ef}$$

Table B2: Required area $A_{i,req}$

HIT-Z, HIT-Z-R, HIT-Z-F			M8	M10	M12	M16	M20
Cracked concrete	$A_{i,req}$	[mm ²]	19200	40800	58800	94700	148000
Uncracked concrete	$A_{i,req}$	[mm ²]	22200	57400	80800	128000	198000

Table B3: Effective area $A_{i,ef}$

Member thickness $h > h_{ef} + 1,5 \cdot c$		
Single anchor and group of anchors with $s > 3 \cdot c$	[mm ²]	$A_{i,ef} = (6 \cdot c) \cdot (h_{ef} + 1,5 \cdot c)$ with $c \geq 5 \cdot d$
Group of anchors with $s \leq 3 \cdot c$	[mm ²]	$A_{i,ef} = (3 \cdot c + s) \cdot (h_{ef} + 1,5 \cdot c)$ with $c \geq 5 \cdot d$ and $s \geq 5 \cdot d$
Member thickness $h \leq h_{ef} + 1,5 \cdot c$		
Single anchor and group of anchors with $s > 3 \cdot c$	[mm ²]	$A_{i,ef} = (6 \cdot c) \cdot h$ with $c \geq 5 \cdot d$
Group of anchors with $s \leq 3 \cdot c$	[mm ²]	$A_{i,ef} = (3 \cdot c + s) \cdot h$ with $c \geq 5 \cdot d$ and $s \geq 5 \cdot d$

c_{min} and s_{min} in 5 mm steps

Injection system Hilti HIT-HY 200-R with HIT-Z / HIT-Z-F / HIT-Z-R

Intended Use





Installation parameters: member thickness, spacing and edge distances

Annex B3

Table B4: Maximum working time and minimum curing time

Temperature in the base material T	Maximum working time t_{work}	Minimum curing time t_{cure}
5 °C	1 hour	4 hours
6 °C to 10 °C	40 min	2,5 hours
11 °C to 20 °C	15 min	1,5 hours
21 °C to 30 °C	9 min	1 hour
31 °C to 40 °C	6 min	1 hour

Table B5: Parameters of drilling and setting tools

Elements	Drill			Installation
	Hammer drilling		Diamond coring	
Anchor rod HIT-Z / HIT-Z(-F,-R)	Drill bit	Hollow drill bit TE-CD, TE-YD		
				
size	d_0 [mm]	d_0 [mm]	d_0 [mm]	HIT-SZ
M8	10	-	10	-
M10	12	12	12	12
M12	14	14	14	14
M16	18	18	18	18
M20	22	22	22	22

Injection system Hilti HIT-HY 200-R with HIT-Z / HIT-Z-F / HIT-Z-R

Intended Use
Maximum working time and minimum working time
Cleaning and setting tools

Annex B4

Installation instruction

Hole drilling

a) Hammer drilling

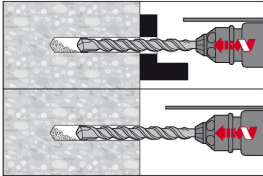

Through-setting: Drill hole through the clearance hole in the fixture to the required drilling depth with a hammer drill set in rotation-hammer mode using an appropriately sized carbide drill bit.

Pre-setting: Drill hole to the required drilling depth with a hammer drill set in rotation-hammer mode using an appropriately sized carbide drill bit.
After drilling is complete, proceed to the "injection preparation" step in the installation instruction.

b) Hammer drilling with hollow drill bit

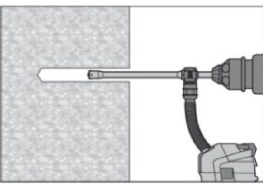

Pre- / Through-setting: Drill hole to the required embedment depth with an appropriately sized Hilti TE-CD or TE-YD hollow drill bit with Hilti vacuum attachment. This drilling system removes the dust and cleans the drill hole during drilling when used in accordance with the user's manual (see Annex A1 – Drill hole condition ②).
After drilling is completed, proceed to the "injection preparation" step in the installation instruction.

c) Diamond coring

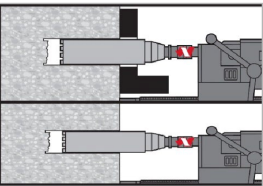

Diamond coring is permissible when suitable diamond core drilling machines and corresponding core bits are used.

Through-setting: Drill hole through the clearance hole in the fixture to the required drilling depth.

Pre-setting: Drill hole to the required embedment depth.

Drill hole cleaning

a) No cleaning required for hammer drilled holes.

b) Hole flushing and evacuation required for wet-drilled diamond cored holes.

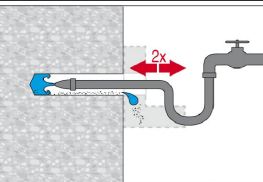

Flush 2 times from the back of the hole over the whole length until water runs clear. Water-line pressure is sufficient.

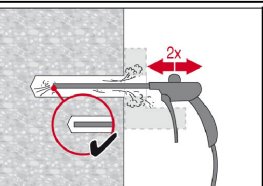

Blow 2 times from the back of the hole (if needed with nozzle extension) with oil-free compressed air (min. 6 bar at 6 m³/h) to evacuate the water.

Injection system Hilti HIT-HY 200-R with HIT-Z / HIT-Z-F / HIT-Z-R

Intended Use
Installation instructions

Annex B5

Checking of setting depth

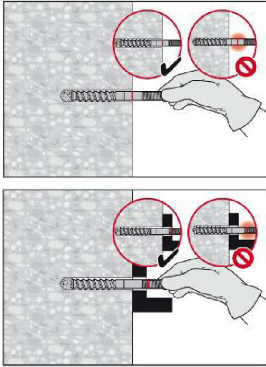

Mark the element and check the setting depth. The element has to fit in the hole until the required embedment depth. If it is not possible to insert the element to the required embedment depth, remove the dust in the drill hole or drill deeper.

Injection preparation

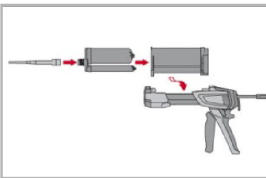

Tightly attach Hilti mixing nozzle HIT-RE-M to foil pack manifold. Do not modify the mixing nozzle.
Observe the instruction for use of the dispenser.
Check foil pack holder for proper function. Insert foil pack into foil pack holder and put holder into the dispenser.

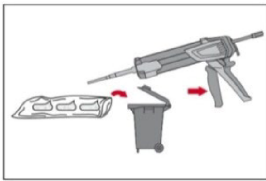

The foil pack opens automatically as dispensing is initiated. Depending on the size of the foil pack an initial amount of adhesive has to be discarded. Discarded quantities are:

2 strokes	for 330 ml foil pack,
3 strokes	for 500 ml foil pack.

Inject adhesive from the back of the drill hole without forming air voids.

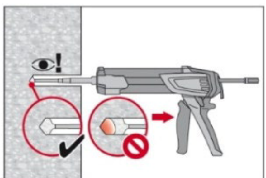

Inject the adhesive starting at the back of the hole, slowly withdrawing the mixer with each trigger pull.

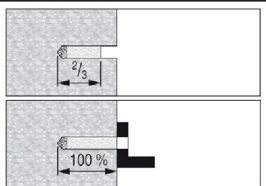

Pre-setting: Fill approximately 2/3 of the drill hole.

Through-setting: Fill 100% of the drill hole.

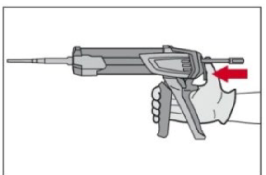

After injection is completed, depressurize the dispenser by pressing the release trigger. This will prevent further adhesive discharge from the mixer.

Injection system Hilti HIT-HY 200-R with HIT-Z / HIT-Z-F / HIT-Z-R

Intended Use
Installation instructions

Annex B6

Overhead installation

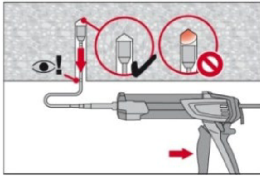

For overhead installation the injection is only possible with the aid of extensions and piston plugs. Assemble HIT-RE-M mixer, extension(s) and appropriately sized piston plug (see Table B5). Insert piston plug to back of the hole and inject adhesive. During injection the piston plug will be naturally extruded out of the drill hole by the adhesive pressure.

Setting the element

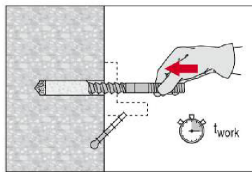

Before use, verify that the element is dry and free of oil and other contaminants. Set element to the required embedment depth before working time t_{work} has elapsed. The working time t_{work} is given in Table B4. After setting the element the annular gap between the anchor and the fixture (through-setting) or concrete (pre-setting) has to be filled with mortar.

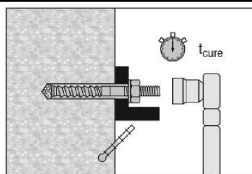

After required curing time t_{cure} (see Table B4) remove excess mortar. The required installation torque T_{inst} is given in Table B1. The anchor can be loaded.

Installation with Seismic filling set

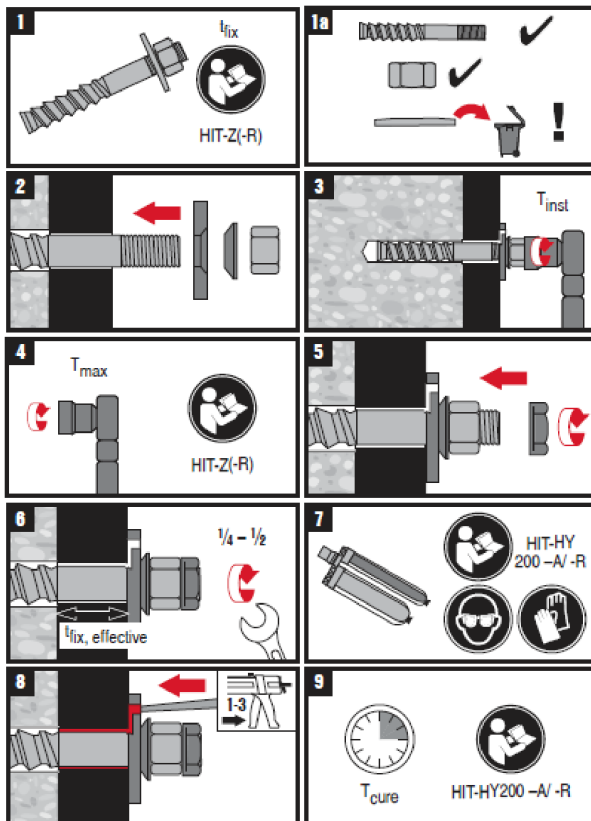

Injection system Hilti HIT-HY 200-R with HIT-Z / HIT-Z-F / HIT-Z-R

Intended Use
Installation instructions

Annex B7

Table C1: Essential characteristics for HIT-Z (-F, -R), under tension load in case of static and quasi static loading

			M8	M10	M12	M16	M20
Installation safety factor	γ_{inst}	[-]	1,0				
Steel failure							
HIT-Z, HIT-Z-F	$N_{Rk,s}$	[kN]	24	38	55	96	146
HIT-Z-R	$N_{Rk,s}$	[kN]	24	38	55	96	146
Pull-out failure							
in uncracked concrete							
Temperature range I: 40 °C / 24 °C	$N_{Rk,p,ucr}$	[kN]	30	44	50	115	150
Temperature range II: 80 °C / 50 °C	$N_{Rk,p,ucr}$	[kN]	26	40	48	105	135
Temperature range III: 120 °C / 72 °C	$N_{Rk,p,ucr}$	[kN]	24	36	44	95	125
in cracked concrete							
Temperature range I: 40 °C / 24 °C	$N_{Rk,p,cr}$	[kN]	26	40	48	105	135
Temperature range II: 80 °C / 50 °C	$N_{Rk,p,cr}$	[kN]	24	36	44	95	125
Temperature range III: 120 °C / 72 °C	$N_{Rk,p,cr}$	[kN]	22	32	40	85	110
Concrete cone failure							
Effective embedment depth	$h_{ef,min}$	[mm]	60	60	60	96	100
	$h_{ef,max}$	[mm]	100	120	144	192	220
Factor for uncracked concrete	$k_1 = k_{ucr,N}$	[-]	11,0				
Factor for cracked concrete	$k_1 = k_{cr,N}$	[-]	7,7				
Edge distance	$c_{Cr,N}$	[mm]	$1,5 \cdot h_{ef}$				
Spacing	$s_{Cr,N}$	[mm]	$3,0 \cdot h_{ef}$				
Splitting failure							
Edge distance $c_{Cr,sp}$ [mm] for	$h / h_{ef} \geq 2,35$		$1,5 \cdot h_{ef}$				
	$2,35 > h / h_{ef} > 1,35$		$6,2 \cdot h_{ef} - 2,0 \cdot h$				
	$h / h_{ef} \leq 1,35$		$3,5 \cdot h_{ef}$				
Spacing	$s_{Cr,sp}$	[mm]	$2 \cdot c_{Cr,sp}$				

Injection system Hilti HIT-HY 200-R with HIT-Z / HIT-Z-F / HIT-Z-R

Performances
Essential characteristics under tension load - static and quasi-static loading

Annex C1

Table C2: Essential characteristics for HIT-Z (-F, -R), under shear load in case of static and quasi static loading

			M8	M10	M12	M16	M20
Installation safety factor	γ_{inst}	[-]	1,0				
Steel failure without lever arm							
HIT-Z, HIT-Z-F	$V_{Rk,s}$	[kN]	12	19	27	48	73
HIT-Z-R	$V_{Rk,s}$	[kN]	14	23	33	57	88
Ductility factor	k_7		1,0				
Steel failure with lever arm							
HIT-Z, HIT-Z-F	$M^0_{Rk,s}$	[Nm]	24	49	85	203	386
HIT-Z-R	$M^0_{Rk,s}$	[Nm]	24	49	85	203	386
Concrete pry-out failure							
Pry-out factor	k_8	[-]	2,0				
Concrete edge failure							
Effective length of anchor in shear loading	l_f	[mm]	h_{ef}				
Diameter of anchor	d^1	[mm]	8	10	12	16	20

Injection system Hilti HIT-HY 200-R with HIT-Z / HIT-Z-F / HIT-Z-R

Performances
Essential characteristics under shear load - static and quasi-static loading

Annex C2

Table C3: Displacements under tension load for HIT-Z (-F, -R) for static and quasi static loading¹⁾

	M8	M10	M12	M16	M20
Uncracked concrete					
Temperature range I: 40 °C / 24 °C					
Displacement δ_{N0} -Factor [mm/kN]	0,03	0,03	0,04	0,05	0,07
Displacement $\delta_{N\infty}$ -Factor [mm/kN]	0,06	0,80	0,10	0,13	0,17
Temperature range I: 80 °C / 50 °C					
Displacement δ_{N0} -Factor [mm/kN]	0,03	0,04	0,04	0,06	0,07
Displacement $\delta_{N\infty}$ -Factor [mm/kN]	0,07	0,09	0,11	0,15	0,18
Temperature range I: 120 °C / 72 °C					
Displacement δ_{N0} -Factor [mm/kN]	0,03	0,04	0,05	0,06	0,08
Displacement $\delta_{N\infty}$ -Factor [mm/kN]	0,07	0,10	0,12	0,16	0,20
Cracked concrete					
Temperature range I: 40 °C / 24 °C					
Displacement δ_{N0} -Factor [mm/kN]	0,06	0,07	0,08	0,09	0,10
Displacement $\delta_{N\infty}$ -Factor [mm/kN]	0,21				
Temperature range I: 80 °C / 50 °C					
Displacement δ_{N0} -Factor [mm/kN]	0,07	0,08	0,08	0,10	0,11
Displacement $\delta_{N\infty}$ -Factor [mm/kN]	0,23				
Temperature range I: 120 °C / 72 °C					
Displacement δ_{N0} -Factor [mm/kN]	0,07	0,08	0,09	0,11	0,12
Displacement $\delta_{N\infty}$ -Factor [mm/kN]	0,25				

¹⁾ Calculation of the displacement

$$\delta_{N0} = \delta_{N0\text{-factor}} \cdot N; \quad \delta_{N\infty} = \delta_{N\infty\text{-factor}} \cdot N; \quad (N: \text{action tensile load}).$$

Table C4: Displacements under shear load for HIT-Z (-F, -R) for static and quasi static loading¹⁾

	M8	M10	M12	M16	M20
Displacement δ_{V0} -Factor [mm/kN]	0,06	0,06	0,05	0,04	0,04
Displacement $\delta_{V\infty}$ -Factor [mm/kN]	0,09	0,08	0,08	0,06	0,06

¹⁾ Calculation of the displacement

$$\delta_{V0} = \delta_{V0\text{-factor}} \cdot V; \quad \delta_{V\infty} = \delta_{V\infty\text{-factor}} \cdot V; \quad (V: \text{action shear load})$$

Injection system Hilti HIT-HY 200-R with HIT-Z / HIT-Z-F / HIT-Z-R

Performances
Displacements in case of static and quasi-static loading

Annex C3

Table C5: Essential characteristics under tension load for HIT-Z (-F, -R) for seismic performance category C1

			M8	M10	M12	M16	M20
Installation safety factor	γ_{inst}	[-]	1,0				
Steel failure							
HIT-Z, HIT-Z-F	$N_{RK,s,seis}$	[kN]	24	38	55	96	146
HIT-Z-R	$N_{RK,s,seis}$	[kN]	24	38	55	96	146
Pull-out failure							
in cracked concrete C20/25							
Temperature range I: 40 °C / 24 °C	$N_{RK,p,seis}$	[kN]	26	38	46	100	130
Temperature range II: 80 °C / 50 °C	$N_{RK,p,seis}$	[kN]	22	34	42	90	115
Temperature range III: 120 °C / 72 °C	$N_{RK,p,seis}$	[kN]	20	32	38	80	105

Table C6: Essential characteristics under shear load for HIT-Z (-F, -R) for seismic performance category C1

			M8	M10	M12	M16	M20
Steel failure							
HIT-Z, HIT-Z-F	$V_{RK,s,seis}$	[kN]	7	17	16	28	45
HIT-Z-R	$V_{RK,s,seis}$	[kN]	8	19	22	31	48

Table C7: Displacements under tension load for HIT-Z (-F, -R) for seismic performance category C1¹⁾

			M8	M10	M12	M16	M20
Displacement	$\delta_{N,seis}$	[mm]	1,2	1,9	1,7	1,3	1,8

¹⁾ Maximum displacement during cycling (seismic event).

Table C8: Displacements under shear load for HIT-Z (-F, -R) for performance category C1¹⁾

			M8	M10	M12	M16	M20
Displacement HIT-Z, HIT-Z-F	$\delta_{V,seis}$	[mm]	4,0	5,0	4,9	4,3	5,5
Displacement HIT-Z-R	$\delta_{V,seis}$	[mm]	5,0	5,6	5,9	6,0	6,4

¹⁾ Maximum displacement during cycling (seismic event).

Injection system Hilti HIT-HY 200-R with HIT-Z / HIT-Z-F / HIT-Z-R

Performances
Essential characteristics and displacements – seismic performance category C1

Annex C4

Table C9: Essential characteristics for HIT-Z (-F, -R) under tension load for seismic performance category C2

			M12	M16	M20
Installation safety factor	γ_{inst}	[-]	1,0		
Steel failure					
HIT-Z, HIT-Z-F	$N_{RK,s,seis}$	[kN]	55	96	146
HIT-Z-R	$N_{RK,s,seis}$	[kN]	55	96	146
Pull-out failure					
in cracked concrete C20/25					
Temperature range I: 40 °C / 24 °C	$N_{RK,p,seis}$	[kN]	22	70	100
Temperature range II: 80 °C / 50 °C	$N_{RK,p,seis}$	[kN]	19	60	80
Temperature range III: 120 °C / 72 °C	$N_{RK,p,seis}$	[kN]	16	50	70

Table C10: Essential characteristics under shear load for HIT-Z (-F, -R) for seismic performance category C2

			M12	M16	M20
Steel failure					
Installation without Hilti seismic filling set					
Effective embedment depth	h_{ef}	[mm]	$h_{ef} < 96$	$h_{ef} < 125$	$h_{ef} < 150$
HIT-Z, HIT-Z-F	$V_{RK,s,seis}$	[kN]	11	17	35
HIT-Z-R	$V_{RK,s,seis}$	[kN]	16	21	35
Effective embedment depth	h_{ef}	[mm]	$h_{ef} \geq 96$	$h_{ef} \geq 125$	$h_{ef} \geq 150$
HIT-Z* (-F, -R)	$V_{RK,s,seis}$	[kN]	21	36	55
Installation with Hilti seismic filling set					
Effective embedment depth	h_{ef}	[mm]	$h_{ef} < 96$	$h_{ef} < 125$	$h_{ef} < 150$
HIT-Z* (-F, -R)	$V_{RK,s,seis}$	[kN]	20	34	40
Effective embedment depth	h_{ef}	[mm]	$h_{ef} \geq 96$	$h_{ef} \geq 125$	$h_{ef} \geq 150$
HIT-Z* (-F, -R)	$V_{RK,s,seis}$	[kN]	23	41	61

*These values apply only for steel element shorter than HIT-Z M16x280 and HIT-Z M20x300.

Injection system Hilti HIT-HY 200-R with HIT-Z / HIT-Z-F / HIT-Z-R

Performances
Essential characteristics and displacements – seismic performance category C2

Annex C5

Table C11: Displacements under tension load for HIT-Z (-F, -R) for seismic performance category C2

			M12	M16	M20
Displacement DLS	$\delta_{N,seis(DLS)}$	[mm]	1,3	1,9	1,2
Displacement ULS	$\delta_{N,seis(ULS)}$	[mm]	3,2	3,6	2,6

Table C12: Displacements under shear load for HIT-Z (-F, -R) for seismic performance category C2

			M12	M16	M20
Installation without Hilti seismic filling set					
Effective embedment depth	h_{ef}	[mm]	$h_{ef} < 96$	$h_{ef} < 125$	$h_{ef} < 150$
Displacement DLS HIT-Z, HIT-Z-F	$\delta_{V,seis(DLS)}$	[mm]	2,8	3,1	4,9
Displacement ULS HIT-Z, HIT-Z-F	$\delta_{V,seis(ULS)}$	[mm]	4,6	6,2	6,8
Displacement DLS HIT-Z-R	$\delta_{V,seis(DLS)}$	[mm]	3,0	3,1	4,9
Displacement ULS HIT-Z-R	$\delta_{V,seis(ULS)}$	[mm]	6,2	6,2	6,8
Effective embedment depth	h_{ef}	[mm]	$h_{ef} \geq 96$	$h_{ef} \geq 125$	$h_{ef} \geq 150$
Displacement DLS HIT-Z (-F, -R)	$\delta_{V,seis(DLS)}$	[mm]	3,4	3,6	1,8
Displacement ULS HIT-Z (-F, -R)	$\delta_{V,seis(ULS)}$	[mm]	6,0	5,9	5,8
Installation with Hilti seismic filling set					
Effective embedment depth	h_{ef}	[mm]	$h_{ef} < 96$	$h_{ef} < 125$	$h_{ef} < 150$
Displacement DLS HIT-Z (-F, -R)	$\delta_{V,seis(DLS)}$	[mm]	1,4	1,7	1,8
Displacement ULS HIT-Z (-F, -R)	$\delta_{V,seis(ULS)}$	[mm]	4,4	5,1	5,6
Effective embedment depth	h_{ef}	[mm]	$h_{ef} \geq 96$	$h_{ef} \geq 125$	$h_{ef} \geq 150$
Displacement DLS HIT-Z (-F, -R)	$\delta_{V,seis(DLS)}$	[mm]	1,4	1,7	4,6
Displacement ULS HIT-Z (-F, -R)	$\delta_{V,seis(ULS)}$	[mm]	5,2	5,1	7,0

Injection system Hilti HIT-HY 200-R with HIT-Z / HIT-Z-F / HIT-Z-R

Performances
Displacements – seismic performance category C2

Annex C6